



# DT122-BE

R-Series



### ► Features

- Supports DDR3/DDR3L SODIMM up to 16GB
- Up to 2x 2.5" or 1x 3.5" SATA drive bay
- 4 independent displays



### ► Panel

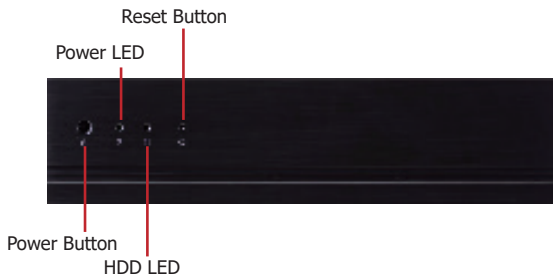

Front View

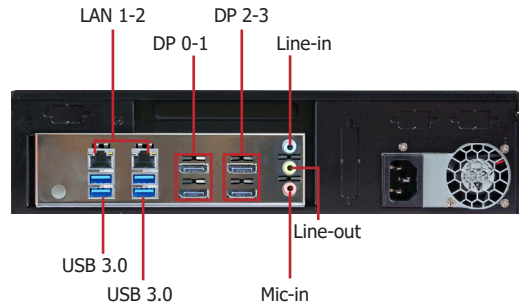

Rear View

### ► Dimensions

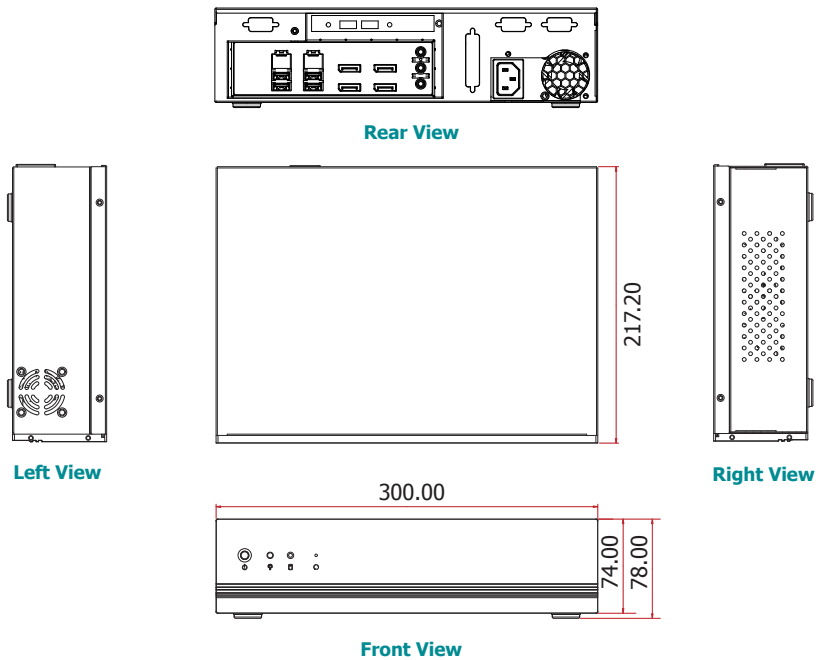

# DT122-BE

## Specifications \* Optional and is not supported in standard model. Please contact your sales representative for more information.

### PROCESSOR SYSTEM

- CPU
  - 2nd Generation AMD® Embedded R-Series APU FP3 BGA (28nm process technology)  
: AMD® RX-427BB, Quad Core, 4M Cache, 2.7GHz (3.6GHz), 35W
- Chipset: AMD® A77E Fusion Controller Hub

### MEMORY

- Two 204-pin SODIMM sockets
- Supports DDR3/DDR3L 1600/1866/2133MHz
- Supports up to 16GB system memory
- Supports dual channel memory interface

### GRAPHICS

- AMD Radeon™ HD 9000 Series Graphics
- Display ports: 4 DP (supports DP++)
- DP: resolution up to 3840x2160 @ 30Hz

### STORAGE

- Up to 2x 2.5" or 1x 3.5" SATA drive bay
  - SATA 3.0 port with data transfer rate up to 6Gb/s

### ETHERNET

- 1 Intel® I210 PCI Express Gigabit Ethernet controller
- 1 Realtek RTL8111EP Ethernet controller
- Integrated 10/100/1000 transceiver
- Fully compliant with IEEE 802.3, IEEE 802.3u, IEEE 802.3ab

### EXPANSION

- 1 expansion slot
  - 1 PCIe x16
- 1 Mini PCIe slot
  - Supports USB and PCIe signals
  - Supports mSATA
  - Supports half size or full size Mini PCIe card

### AUDIO

- Realtek ALC888 7.1-channel High Definition Audio

### I/O PORTS

- Front Panel
  - 1 Power button
  - 1 Reset button
  - 2 LED indicators: Power, HDD
- Rear Panel
  - 4 USB 3.0
  - 4 DP
  - 2 RJ45 LAN
  - Mic-in, line-in and line-out jacks

### POWER

- Power type
  - Flex ATX
- Power input voltage
  - AC 100-240V, 250W

### COOLING SYSTEM

- 1 system fan

### ENVIRONMENT

- Temperature
  - Operating: 0°C~45°C
  - Storage: -20°C~60°C
- Humidity
  - 85% RH at 45°C, 1 week
- Operating Vibration
  - Operating: sine 5~500Hz, 1G
  - Non-operating: sine 10~500Hz, 3G
- Operating Shock
  - Operating: 3G
  - Non-operating: 5G

### CONSTRUCTION

- Front panel: aluminum
- Rear chassis: sheet metal

### MOUNTING

- 2 types of wall mount bracket
  - Type A
  - Type B

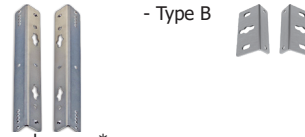

- Brackets and screws\*

### DIMENSIONS

- 300mm x 75mm x 217mm (W x H x D)

### WEIGHT

- 3.7 kg

### OS SUPPORT

- Windows 7 Ultimate x86 & SP1 (32-bit)
- Windows 7 Ultimate x64 & SP1 (64-bit)
- Windows 8.1 Embedded Pro x64 (64-bit)

### OTHER FEATURES

- Watchdog Timer function

### CERTIFICATION

- CE
- FCC Class A
- RoHS

# DT122-BE

▶ Wall Mounting

**Type A Wall mount bracket**

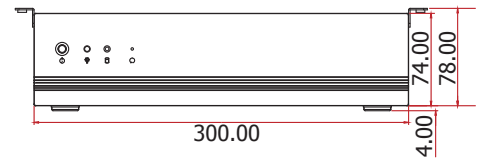
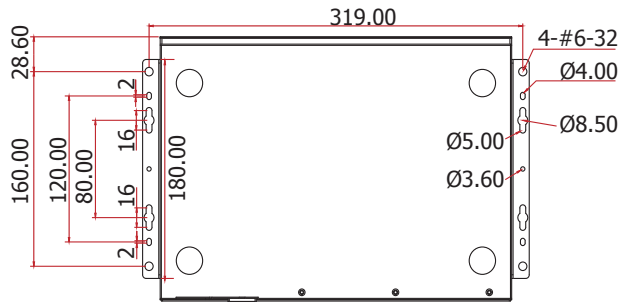
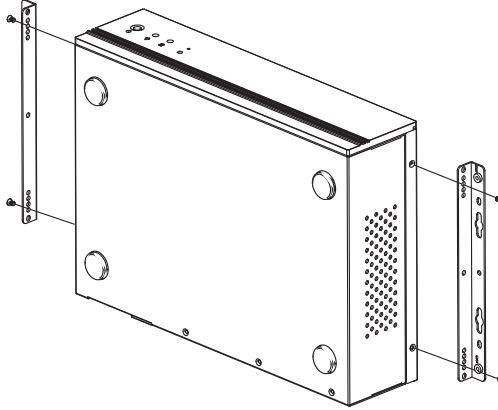

**Type B Wall mount bracket**

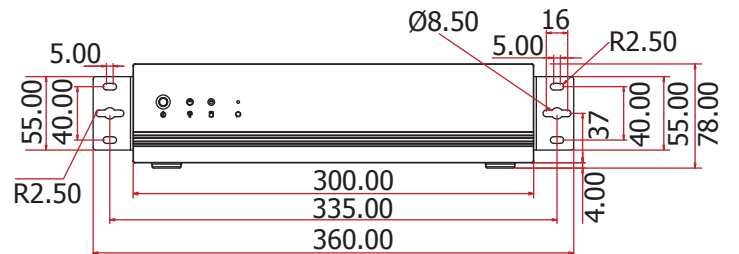
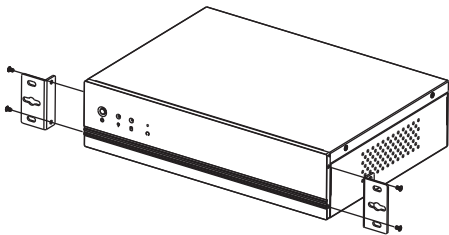

## DT122-BE

## ► Ordering Information

Model Name	Part Number	Description
DT122-BE	750-DT1220-800G	DT122-BE: BE170 RoHS, 1 PCIe x16

## ► Optional Items

Optional Items	Part Number	Description
<b>Memory</b>	785-RSOD38G-L	SODIMM, DDR3L Module (supports dual voltage 1.5V DDR3/1.35V DDR3L), 8GB, RoHS
	785-RSOD34G-L	SODIMM, DDR3L Module (supports dual voltage 1.5V DDR3/1.35V DDR3L), 4GB, RoHS
	785-RSOD32G-L	SODIMM, DDR3L Module (supports dual voltage 1.5V DDR3/1.35V DDR3L), 2GB, RoHS
	785-RSOD31G	SODIMM, DDR3 Module, 1GB, RoHS
<b>HDD</b>	785-H353T0B	3.5" SATA HDD, 500GB, RoHS
	785-H25500G	2.5" SATA HDD, 500GB, RoHS
	785-H25320G	2.5" SATA HDD, 320GB, RoHS
	785-S251TBG	2.5" SATA SSD, 1TB MLC, RoHS
	785-S25512G	2.5" SATA SSD, 512GB MLC, RoHS
	785-S25256G	2.5" SATA SSD, 256GB MLC, RoHS
	785-S25128G	2.5" SATA SSD, 128GB MLC, RoHS
	785-S25064G	2.5" SATA SSD, 64GB MLC, RoHS
<b>mSATA</b>	785-MS128GMF	mSATA Card, 128GB MLC, RoHS
	785-MS64GMF	mSATA Card, 64GB MLC, RoHS
	785-MS32GMF	mSATA Card, 32GB MLC, RoHS
	785-MS16GMF	mSATA Card, 16GB MLC, RoHS
	785-MS08GMF	mSATA Card, 8GB MLC, RoHS
	785-MS04GMF	mSATA Card, 4GB MLC, RoHS
<b>Wi-Fi</b>	761-110091-000G	Wi-Fi Kit, RoHS
<b>Power Cord</b>	785-PWRD	Power Cord, Standards (USA/EUR/CH), 1.8m, RoHS
<b>Wall Mount</b>	761-DT1220-100G	DT122 Type A Wall Mount Kit for Top Cover, RoHS
	761-DT1220-000G	DT122 Type B Wall Mount Kit for Front Cover, RoHS

## ► Packing List

• 1 DT122-BE system unit
• 1 CPU cooler
• 1 HDD drive bay kit
• 1 Quick Installation Guide