



CMS310-W480E/Q470E

microATX Industrial Motherboard
User's Manual

Copyright

This publication contains information that is protected by copyright. No part of it may be reproduced in any form or by any means or used to make any transformation/adaptation without the prior written permission from the copyright holders.

This publication is provided for informational purposes only. The manufacturer makes no representations or warranties with respect to the contents or use of this manual and specifically disclaims any express or implied warranties of merchantability or fitness for any particular purpose. The user will assume the entire risk of the use or the results of the use of this document. Further, the manufacturer reserves the right to revise this publication and make changes to its contents at any time, without obligation to notify any person or entity of such revisions or changes.

Changes after the publication's first release will be based on the product's revision. The website will always provide the most updated information.

© 2022. All Rights Reserved.

Trademarks

Product names or trademarks appearing in this manual are for identification purpose only and are the properties of the respective owners.

FCC and DOC Statement on Class B

This equipment has been tested and found to comply with the limits for a Class B digital device, pursuant to Part 15 of the FCC rules. These limits are designed to provide reasonable protection against harmful interference when the equipment is operated in a residential installation. This equipment generates, uses and can radiate radio frequency energy and, if not installed and used in accordance with the instruction manual, may cause harmful interference to radio communications. However, there is no guarantee that interference will not occur in a particular installation. If this equipment does cause harmful interference to radio or television reception, which can be determined by turning the equipment off and on, the user is encouraged to try to correct the interference by one or more of the following measures:

- Reorient or relocate the receiving antenna.
- Increase the separation between the equipment and the receiver.
- Connect the equipment into an outlet on a circuit different from that to which the receiver is connected.
- Consult the dealer or an experienced radio TV technician for help.

Notice:

- The changes or modifications not expressly approved by the party responsible for compliance could void the user's authority to operate the equipment.
- Shielded interface cables must be used in order to comply with the emission limits.

Table of Contents

Chapter 1 - Introduction	6
Specifications	6
Features	8
Block Diagram	9
Chapter 2 - Hardware Installation	10
Board Layout.....	10
System Memory	11
Installing the DIMM Module	11
Removing the DIMM Module.....	12
CPU.....	13
Installing the CPU Fan and Heat Sink.....	13
Jumper Settings	14
CLEAR CMOS Data	14
DIO Power	14
COM1/COM2 RS232/422/485 Select	15
COM1/COM2 RS232 Power Select	16
AT/ATX Mode - JP26.....	17
USB Power Control - JP24.....	18
Rear I/O Ports.....	19
USB Ports	20
Graphics Interfaces	21
RJ45 LAN Ports	22
Audio	22
Internal I/O Connectors	23
SATA (Serial ATA)	23
Digital I/O Connector (2.0mm pitch).....	23
COM (Serial) ports.....	24
Cooling Fan Connectors.....	25
Power Connector	25
Front Panel	26
LAN LED Connector.....	27
S/PDIF Connector.....	27
SMBus Connector	28
LPC Connector.....	28
PS2.....	29
Chassis Intrusion Connector	29
InnoAGE HDR1 (JP27)	30
InnoAGE HDR1 (JP27)	30
Expansion Slots	31
Installing the M.2 Module	31
Battery	32
Chapter 3 - BIOS Setup	33
Overview	33
Main.....	34
Advanced	34
ACPI Configuration.....	35
CPU Configuration	36
Video Configuration.....	36
Audio Configuration.....	37
SATA Configuration	37
USB Configuration	38
USB Power Control.....	38

PCI Express Configuration	39
System Agent (SA) Configuration	40
ME Configuration.....	40
Debug Configuration	41
UEFI Device Manager	41
SIO NCT6126D.....	42
Console Redirection	44
Security	45
Boot	45
Exit.....	47
Updating the BIOS	47
Notice: BIOS SPI ROM.....	47
Chapter 4 - RAID	48
RAID Levels Description.....	48
Setup Procedure	48

About this Manual

This manual can be downloaded from the website.

The manual is subject to change and update without notice, and may be based on editions that do not resemble your actual products. Please visit our website or contact our sales representatives for the latest editions.

Warranty

- Warranty does not cover damages or failures that occur from misuse of the product, inability to use the product, unauthorized replacement or alteration of components and product specifications.
- The warranty is void if the product has been subjected to physical abuse, improper installation, modification, accidents or unauthorized repair of the product.
- Unless otherwise instructed in this user's manual, the user may not, under any circumstances, attempt to perform service, adjustments or repairs on the product, whether in or out of warranty. It must be returned to the purchase point, factory or authorized service agency for all such work.
- We will not be liable for any indirect, special, incidental or consequential damages to the product that has been modified or altered.

Static Electricity Precautions

It is quite easy to inadvertently damage your PC, system board, components or devices even before installing them in your system unit. Static electrical discharge can damage computer components without causing any signs of physical damage. You must take extra care in handling them to ensure against electrostatic build-up.

- To prevent electrostatic build-up, leave the system board in its anti-static bag until you are ready to install it.
- Wear an antistatic wrist strap.
- Do all preparation work on a static-free surface.
- Hold the device only by its edges. Be careful not to touch any of the components, contacts or connections.
- Avoid touching the pins or contacts on all modules and connectors. Hold modules or connectors by their ends.



Important:

Electrostatic discharge (ESD) can damage your processor, disk drive and other components. Perform the upgrade instruction procedures described at an ESD workstation only. If such a station is not available, you can provide some ESD protection by wearing an antistatic wrist strap and attaching it to a metal part of the system chassis. If a wrist strap is unavailable, establish and maintain contact with the system chassis throughout any procedures requiring ESD protection.

Safety Measures

- To avoid damage to the system, use the correct AC input voltage range.
- To reduce the risk of electric shock, unplug the power cord before removing the system chassis cover for installation or servicing. After installation or servicing, cover the system chassis before plugging the power cord.

About the Package

The package contains the following items. If any of these items are missing or damaged, please contact your dealer or sales representative for assistance.

- 1 CMS310-W480E/Q470E motherboard
- 1 COM port cable (W/Bracket, Length: 300mm, 2 x COM ports)
- 1 Serial ATA data cable (W/LOCK, Length: 500mm)
- 1 I/O shield

The board and accessories in the package may not come similar to the information listed above. This may differ in accordance with the sales region or models in which it was sold. For more information about the standard package in your region, please contact your dealer or sales representative.

Optional Items

- USB 2.0 port cable (Length: 350/398mm)
- USB3.1 Gen2 port cable (Length: 350mm)
- COM port cable (Length: 300mm, 2 x COM ports)
- Serial ATA data cable (Length: 500mm, W/LOCK)
- Thermal solution (For 35W, Height: 37.3mm)
- Thermal solution (For 65W, Height: 72.8mm)
- Thermal solution (For 95W, Height: 69.3mm)
- DP to HDMI Dongle
- PS2 KB/MS Cable (Length: 400mm)
- EXT-RS232 (4 ports RS-232 LPC module)
- EXT-RS485 (4 ports RS-485 LPC module)

The board and accessories in the package may not come similar to the information listed above. This may differ in accordance with the sales region or models in which it was sold. For more information about the standard package in your region, please contact your dealer or sales representative.

Before Using the System Board

When installing the system board in a new system, you will need at least the following internal components.

- Memory module
- Storage device such as a hard disk drive.
- Power supply

External system peripherals may also be required for navigation and display, including at least a keyboard, a mouse and a video display monitor.

Chapter 1 - Introduction

► Specifications

SYSTEM	Processor	10th Generation Intel® LGA 1200 Socket Processors, TDP support up to 125W Intel® Xeon® W-1290E (10 Cores, 20M Cache, up to 4.8 GHz, ECC support); 95W (W480E only) Intel® Xeon® W-1290TE (10 Cores, 20M Cache, up to 4.5 GHz, ECC support); 35W (W480E only) Intel® Xeon® W-1270E (8 Cores, 16M Cache, up to 4.8 GHz, ECC support); 80W (W480E only) Intel® Xeon® W-1270TE (8 Cores, 16M Cache, up to 4.4 GHz, ECC support); 35W (W480E only) Intel® Xeon® W-1250E (6 Cores, 12M Cache, up to 4.7 GHz, ECC support); 80W (W480E only) Intel® Xeon® W-1250TE (6 Cores, 12M Cache, up to 3.8 GHz, ECC support); 35W (W480E only) Intel® Core™ i9-10900E (10 Cores, 20M Cache, up to 4.7 GHz); 65W Intel® Core™ i9-10900TE (10 Cores, 20M Cache, up to 4.5 GHz); 35W Intel® Core™ i7-10700E (8 Cores, 16M Cache, up to 4.5 GHz); 65W Intel® Core™ i7-10700TE (8 Cores, 16M Cache, up to 4.4 GHz); 35W Intel® Core™ i5-10500E (6 Cores, 12M Cache, up to 4.2 GHz); 65W Intel® Core™ i5-10500TE (6 Cores, 12M Cache, up to 3.7 GHz); 35W Intel® Core™ i3-10100E (4 Cores, 6M Cache, 3.8 GHz, ECC support on W480E SKU); 65W Intel® Core™ i3-10100TE (4 Cores, 6M Cache, to 3.6 GHz, ECC support on W480E SKU); 35W Intel® Pentium® G6400E (2 Cores, 4M Cache, 3.8 GHz); 58W Intel® Celeron® G5900E (2 Cores, 2M Cache, 3.2 GHz); 58W Intel® Celeron® G5900TE (2 Cores, 2M Cache, 3.0 GHz); 35W
	Chipset	Intel® W480E/Q470E Chipset
	Memory	Four 288-pin DIMM up to 128GB Dual Channel DDR4 2400/2666/2933 MHz (ECC support: W480E only)
	BIOS	Insyde SPI 128Mbit

GRAPHICS	Controller	Intel® HD Gen 9 Graphics
	Feature	OpenGL 4.5, DirectX 12, OpenCL 2.1 HW Decode: AVC/H.264, MPEG2, VC1/WMV9, JPEG/MJPEG, HEVC/H265, VP8, VP9 HW Encode: MPEG2, AVC/H264, JPEG, HEVC/H265, VP8, VP9
	Display	1 x DP++ 1 x VGA 1 x HDMI 1.4b DP++: resolution up to 4096x2106 @ 60Hz VGA: resolution up to 1920x1200 @ 60Hz HDMI resolution up to 4096x2160 @ 24Hz
EXPANSION	Interface	2 x PCIe x16 (Gen 3) (1 x16 signals or 2 x8 signals) 2 x PCIe x4 (Gen 3) 1 x M.2 2230 E key (PCIe/USB 2.0/Intel CNVi support) 1 x M.2 2242/2260/2280 M key (PCIe x4 Gen3 NVMe/SATA/Intel Optane Memory support)
AUDIO	Audio Codec	Realtek ALC888
ETHERNET	Controller	1 x Intel® i219LM PCIe (10/100/1000Mbps) (only Xeon, Core i9/i7/i5 support iAMT) 1 x Intel® i210AT PCIe (10/100/1000Mbps) 2 x Intel® i210AT PCIe (10/100/1000Mbps) (opt. by request, MOQ required)
REAR I/O	Ethernet	2 x GbE (RJ-45) or 4 x GbE (RJ-45)
	USB	2 x USB 3.2 Gen 2 4 x USB 3.2 Gen 1
	Display	1 x DP++ 1 x VGA 1 x HDMI
	Audio	1 x Line-out 1 x Mic-in 1 x Line-in (colay, opt. by request, MOQ required)
INTERNAL I/O	Serial	2 x RS-232/422/485 (RS-232 w/ power) (2.54mm pitch) 2 x RS-232
	USB	4 x USB 2.0 (2.54mm pitch) (1 x USB 2.0 colay vertical Type A) 2 x USB 3.2 Gen2
	Audio	1 x S/PDIF 1 x Front Audio Header
	SATA	4 x SATA 3.0 (up to 6Gb/s) RAID 0/1/5/10

	PS/2	1 x PS/2 (2.54mm pitch)
	DIO	1 x 16-bit DIO (2.0mm pitch)
	LPC	1 x LPC
	SMBus	1 x SMBus
WATCHDOG TIMER	Output & Interval	System Reset, Programmable via Software from 1 to 255 sec/min
SECURITY	TPM	Infineon TPM 2.0 (Available Upon Request, MOQ required)
POWER	Type	ATX
	Connector	8-pin ATX 12V power 24-pin ATX power
	Consumption	Typical: i9-10900K: 3.3V @ 0.41A (1.35W); 5V @ 0.76A (3.8W); 12V @ 0.34A (4.08W) Max.: i9-10900K: 3.3V @ 0.46A (1.52W); 5V @ 1.61A (8.05W); 12V @ 13.97A (167.64W)
	RTC Battery	CR2032 Coin Cell
OS SUPPORT		Windows 10 IoT Enterprise 64-bit Linux
ENVIRONMENT	Temperature	Operating: -5 to 65°C Storage: -30 to 60°C with RTC Battery; -40 to 85°C without RTC Battery
	Humidity	Operating: 5 to 90% RH Storage: 5 to 90% RH
	MTBF	487,616 hrs @ 25°C; 271,110 hrs @ 40°C ; 303,603 hrs @ 45°C ; 168,586 hrs @ 60°C Calculation Model: Telcordia Issue 4 Environment: GB, GC - Ground Benign, Controlled
MECHANICAL	Dimensions	microATX form factor 244mm (9.6") x 244mm (9.6")
	Height	PCB: 1.6mm Top Side: 31.47mm, Bottom Side: 4.4mm
CERTIFICA- TIONS		CE, FCC, RoHS, UKCA

► Features

Watchdog Timer

The Watchdog Timer function allows your application to regularly “clear” the system at the set time interval. If the system hangs or fails to function, it will reset at the set time interval so that your system will continue to operate.

DDR4

DDR4 delivers increased system bandwidth and improves performance. The advantages of DDR4 provide an extended battery life and improve the performance at a lower power than DDR3/DDR2.

Serial ATA

Serial ATA is a storage interface that is compliant with SATA 1.0a specification. With speed of up to 6Gb/s (SATA 3.0), it improves hard drive performance faster than the standard parallel ATA whose data transfer rate is 100MB/s.

Gigabit LAN

Two Intel® Gigabit LAN controllers support up to 1Gbps data transmission.

Wake-On-LAN

This feature allows the network to remotely wake up a Soft Power Down (Soft-Off) PC. It is supported via the onboard LAN port or via a PCI LAN card that uses the PCI PME (Power Management Event) signal. However, if your system is in the Suspend mode, you can power-on the system only through an IRQ or DMA interrupt.

Wake-On-USB

This function allows you to use a USB keyboard or USB mouse to wake up a system from the S3 (STR - Suspend To RAM) state.

PCI Express

PCI Express is a high bandwidth I/O infrastructure that possesses the ability to scale speeds by forming multiple lanes. The x4 PCI Express lane supports transfer rate of 4 Gigabyte per second (2 directions). The PCI Express architecture also supports high performance graphics infrastructure by enhancing the capability of a PCIe x16 Gen 3 at 16GB/s bandwidth (8GB/s in each direction).

ACPI STR

The system board is designed to meet the ACPI (Advanced Configuration and Power Interface) specification. ACPI has energy saving features that enables PCs to implement Power Management and Plug-and-Play with operating systems that support OS Direct Power Management. ACPI when enabled in the Power Management Setup will allow you to use the Suspend to RAM function.

With the Suspend to RAM function enabled, you can power-off the system at once by pressing the power button or selecting “Standby” when you shut down Windows® without having to go through the sometimes tiresome process of closing files, applications and operating system. This is because the system is capable of storing all programs and data files during the entire operating session into RAM (Random Access Memory) when it powers-off. The operating session will resume exactly where you left off the next time you power-on the system.

Power Failure Recovery

When power returns after an AC power failure, you may choose to either power-on the system manually or let the system power-on automatically.

USB

The system board supports the new USB 3.2 Gen 2. It is capable of running at a maximum transmission speed of up to 10 Gbit/s (1250 MB/s), and is faster than USB 2.0 (480 Mbit/s, or 60 MB/s) and USB 1.1 (12Mb/s). USB 3.2 reduces the time required for data transmission, reduces power consumption, and is backward compatible with USB 2.0. It is a marked improvement in device transfer speeds between your computer and a wide range of simultaneously accessible external Plug and Play peripherals.

RTC Timer

The Real Time Clock (RTC) installed on the system board allows your system to automatically power-on on the set date and time.

► Block Diagram

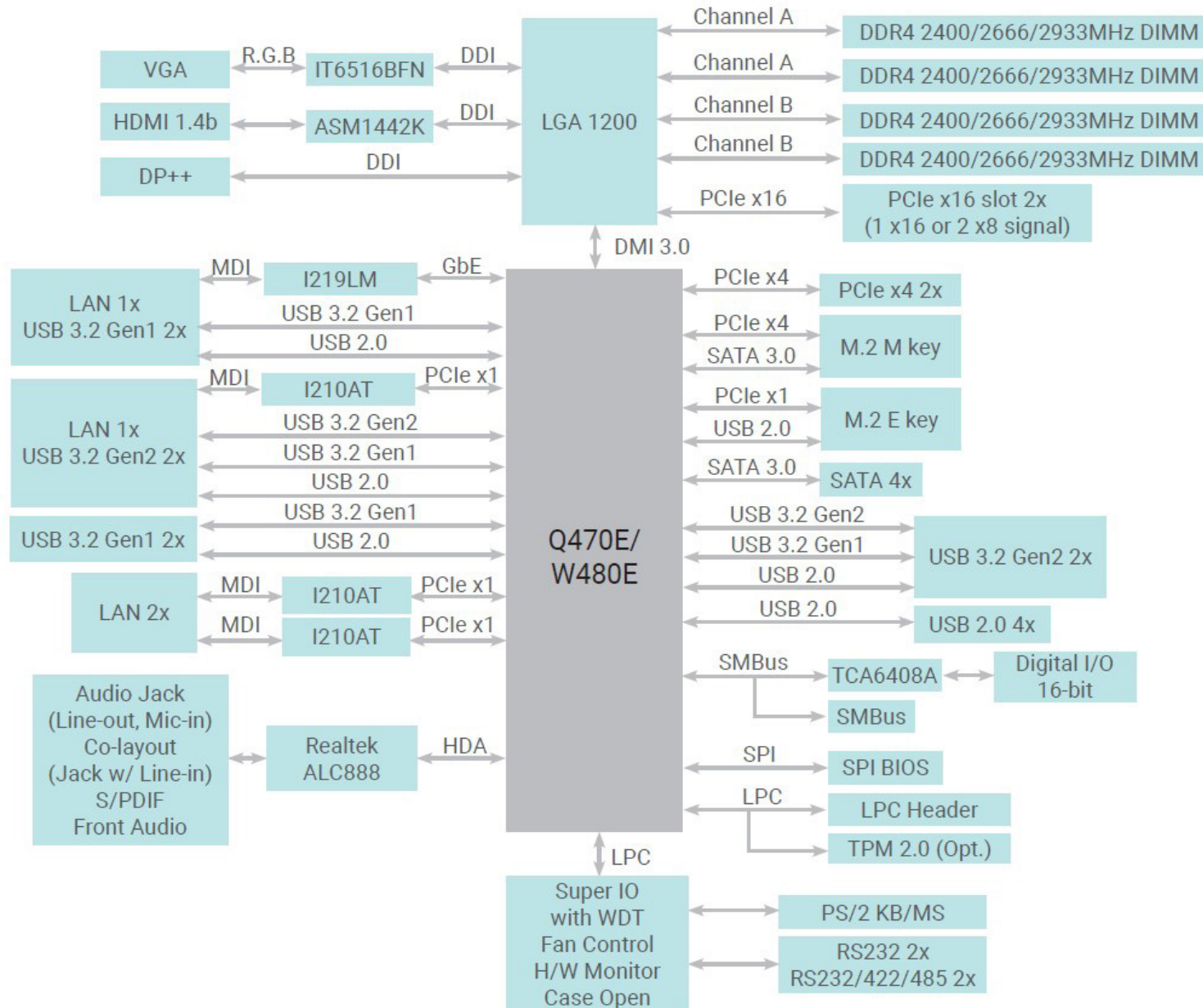

► System Memory

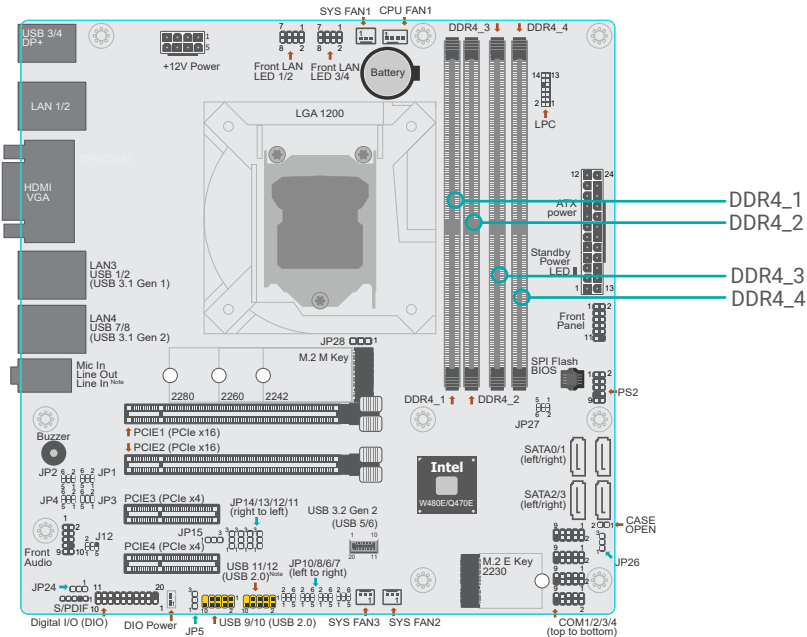

The system board supports the following memory interface.

Single Channel (SC)

Data will be accessed in chunks of 64 bits from the memory channels. DIMMs are on the same channel. DIMMs in a channel can be identical or completely different. However, we highly recommend using identical DIMMs. Not all slots need to be populated.

Dual Channel (DC)

Data will be accessed in chunks of 128 bits from the memory channels. Dual channel provides better system performance because it doubles the data transfer rate.

Features

- Four 288-pin DIMM up to 128GB
- Dual Channel DDR4 2400/2666/2933 MHz (ECC support: W480E only)

► System Memory

Installing the DIMM Module

Before installing the memory module, please make sure that the following safety cautions are well-attended.

- Make sure the PC and all other peripheral devices connected to it has been powered down.
- Disconnect all power cords and cables.
- Locate the DIMM socket on the system board
- Make sure the notch on memory card is aligned to the key on the socket.

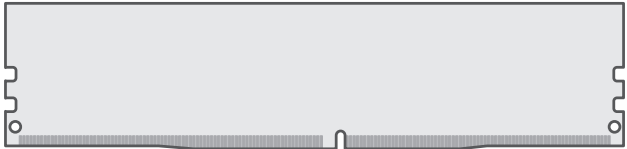

Memory Module

Notch

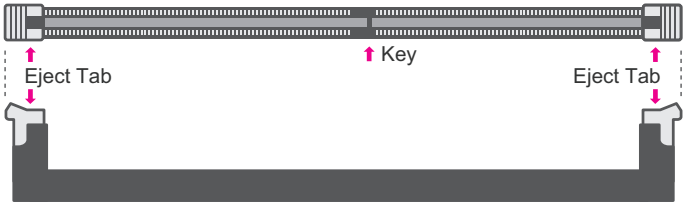

Socket Top View

Socket Side View

► System Memory ► Installing the DIMM Module

Please follow the steps below to install the memory card into the socket.

Step 1:
Press the eject tabs at both ends of the socket outward and downward to release them from the locked position.

Step 2:
Insert the memory card into the slot while making sure the notch and the key are aligned. Press the card down firmly with fingers while applying and maintaining even pressure on both ends.

Step 3:
The tabs snap automatically to the edges of the card and lock the card in place.

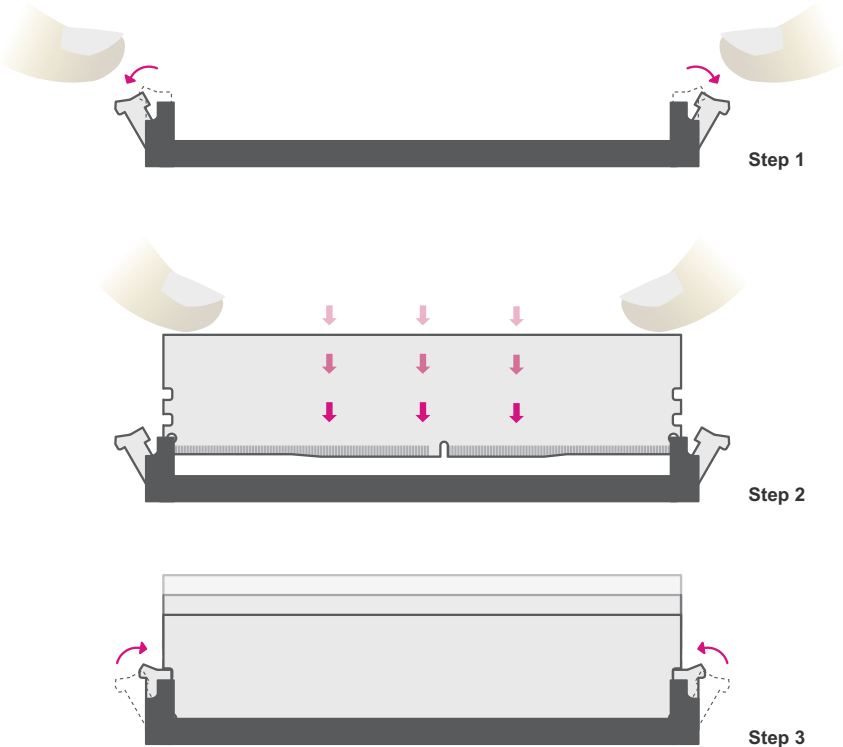

► System Memory

Removing the DIMM Module

Please follow the steps below to remove the memory card from the socket.

Step 1:
Press the eject tabs at both ends of the socket outward and downward to release them from the locked position.

Step 2:
The memory card ejects from the slot automatically.

Step 3:
Hold the card by its edges and remove it from the slot.

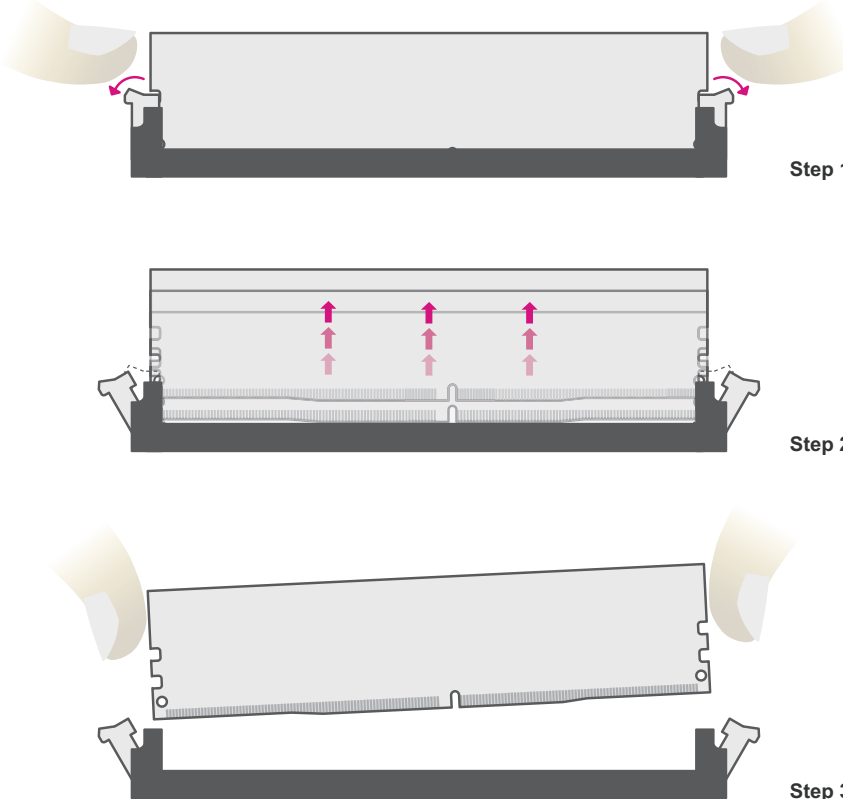

► CPU

Installing the CPU Fan and Heat Sink

The CPU must be kept cool by using a CPU fan with heat sink. Without sufficient air circulation across the CPU and heat sink, the CPU will overheat damaging both the CPU and system board.

Before you place the heat sink on the CPU, you must apply a thermal paste onto the top of the heat sink. The thermal paste is usually supplied when you purchase the fan with heat sink assembly. Do not spread the paste all over the surface. When you later place the CPU on top of the heat sink, the compound will disperse evenly.

Some heat sinks come with a patch of pre-applied thermal paste. Do not apply thermal paste if the fan with heat sink already has a patch of thermal paste on its underside. Peel the strip that covers the paste before you place the CPU on top of the heat sink.

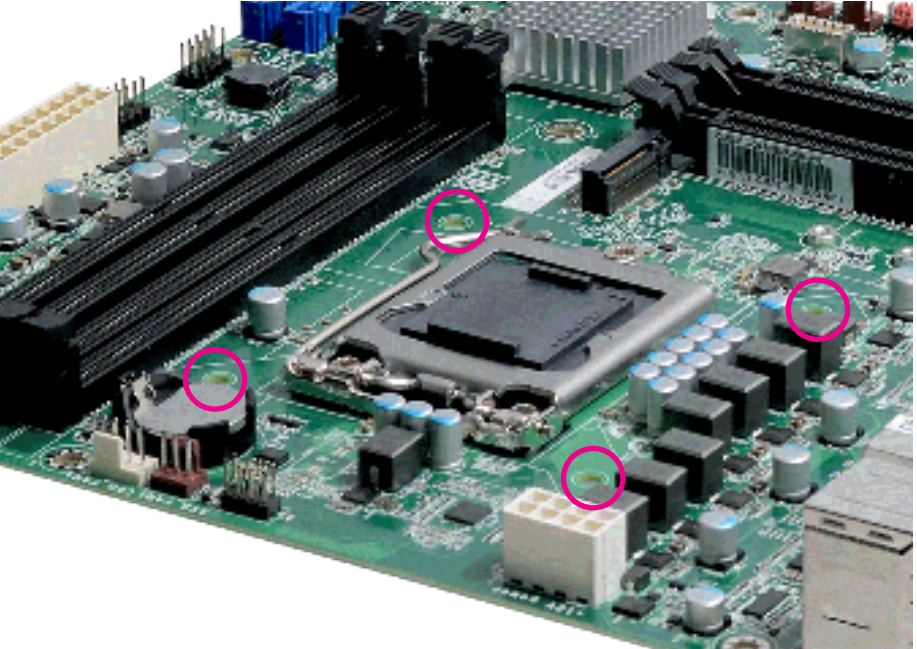

There are 4 screw holes around the CPU for the heat sink to be mounted.

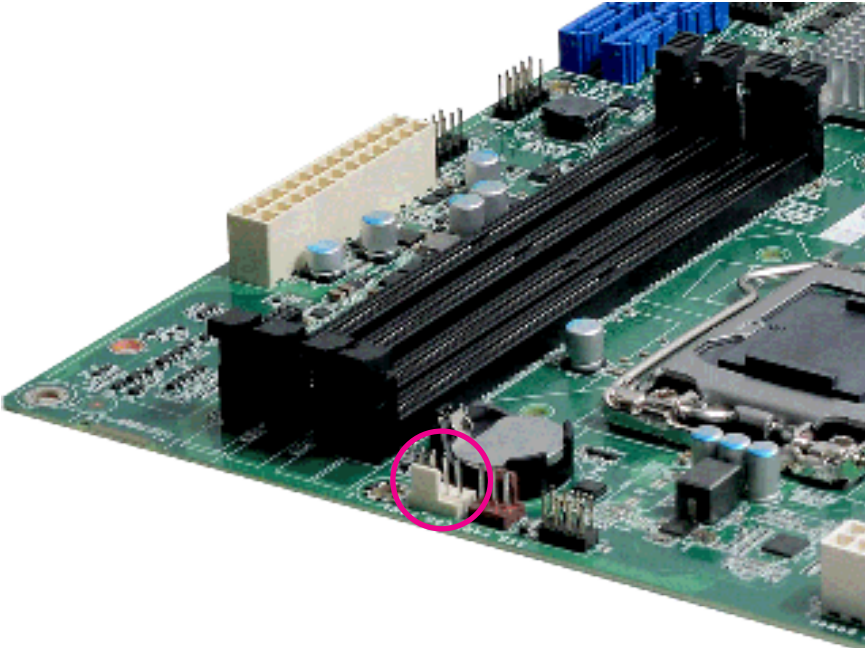

Align the 4 screw holes and tighten the heat sink up by inserting screws, DO remember to connect the fan cable on the board. (The location of fan connector may vary.)

► **Jumper Settings**

CLEAR CMOS Data

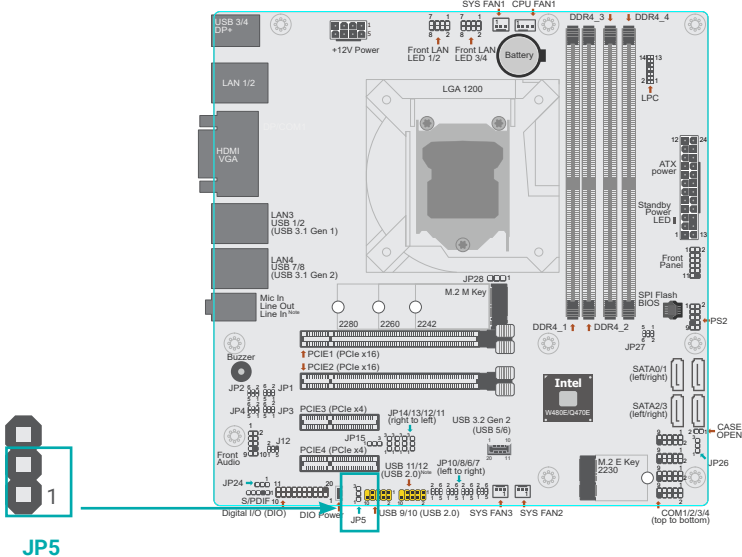

If any anomaly of the followings is encountered –

- a) CMOS data is corrupted;
- b) you forgot the supervisor or user password;
- c) failure to start the system due to BIOS mis-configuration

– it is suggested that the system be reconfigured with default values stored in the ROM BIOS. To load the default values stored in the ROM BIOS, please follow the steps below.

1. Power-off the system and unplug the power cord.
2. Put a jumper cap on pin 2 and pin 3. Wait for a few seconds and set it back to its default setting, i.e. jumper cap on pin 1 and pin 2.
3. Plug the power cord and power-on the system.



■ 1-2 On: Normal (default)



■ 2-3 On: Clear CMOS Data

DIO Power



JP15/14/13/12/11

JP11(DIO 0~3 PWR) / JP12(DIO 4~7 PWR) / JP13(DIO 8~11 PWR) / JP14(DIO 12~15 PWR)



■ 1-2 On: DIO Power (default)



■ 2-3 On: GND

JP15(DIO PWR)



■ 1-2 On: 5VSB (default)



■ 2-3 On: 5V

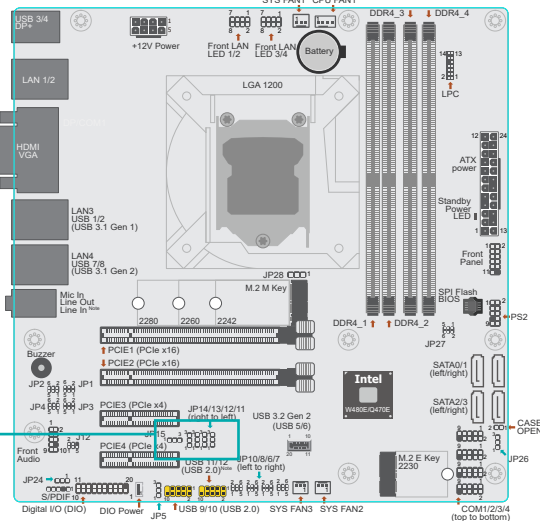

Jumper Settings

COM1/COM2 RS232/422/485 Select

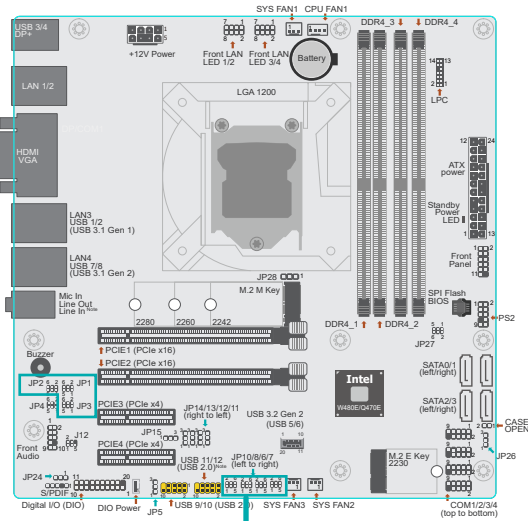

JP2/JP1/
JP3
(COM 1)

JP10/JP8/JP6
(COM 2)

■ JP1 (COM1)/JP8 (COM2)

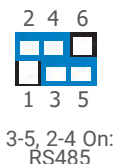
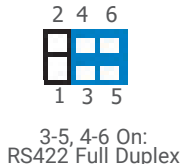
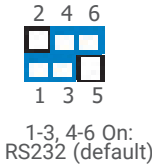

■ JP2/JP3 (COM 1)

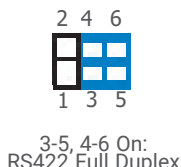
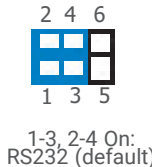

■ JP6/JP10 (COM 2)

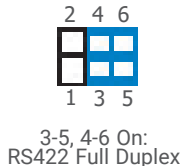
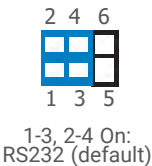

JP1/JP2/JP3 (for COM 1) and JP6/JP8/JP10 (for COM 2) are used to configure the COM ports to RS232, RS422 (Full Duplex) or RS485. When COM 1 RS232/422/485 is selected, JP1 and JP2 must be set in accordance to JP3. When COM 2 RS232/422/485 is selected, JP6 and JP8 must be set in accordance to JP10. The pin functions of the COM ports will vary according to the jumpers' setting.

► Jumper Settings

COM1/COM2 RS232 Power Select

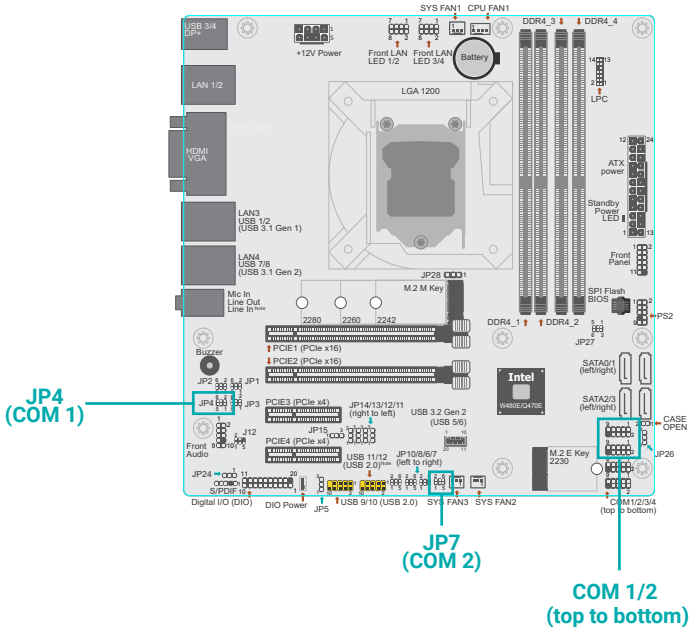

JP4 (for COM 1) and JP7 (for COM 2) are used to configure Serial COM ports to pure RS232 or RS232 with power. The pin functions of COM 1 and COM 2 will vary according to JP4's and JP7's setting respectively.

■ JP4 (COM 1)

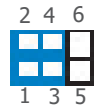

1-3, 2-4 On:
RS232 (default)

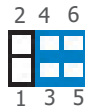

3-5, 4-6 On:
RS232 with power

■ JP7 (COM 2)

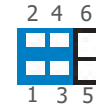

1-3, 2-4 On:
RS232 (default)



3-5, 4-6 On:
RS232 with power

COM1/COM2 RS232 Power Select

Pins	RS232	RS232 with power
1	DCD-	+12V
2	SIN-	RD
3	SO-	TD
4	DTR-	DTR-
5	GND	GND
6	DSR-	DSR-
7	RTS-	RTS-
8	CTS-	CTS-
9	RI-	+5V



► Jumper Settings

AT/ATX Mode - JP26

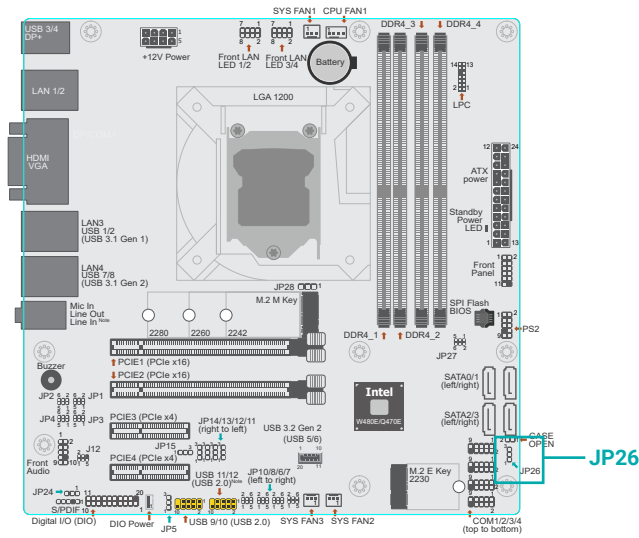

■ AT mode

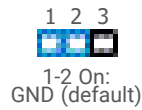

■ ATX mode



► Jumper Settings

M.2 M-key Power Voltage - JP28

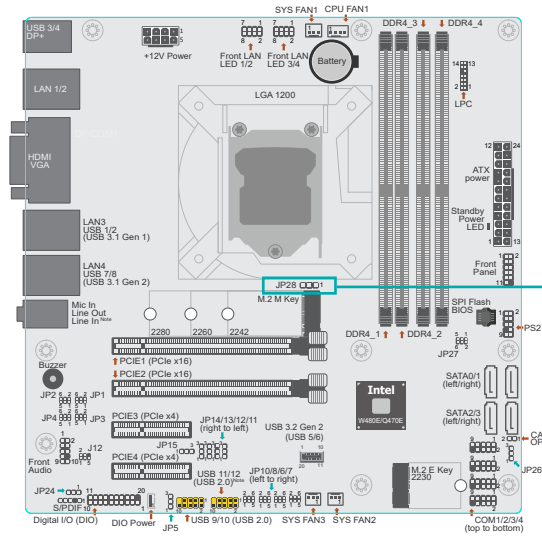

► Jumper Settings

USB Power Control - JP24

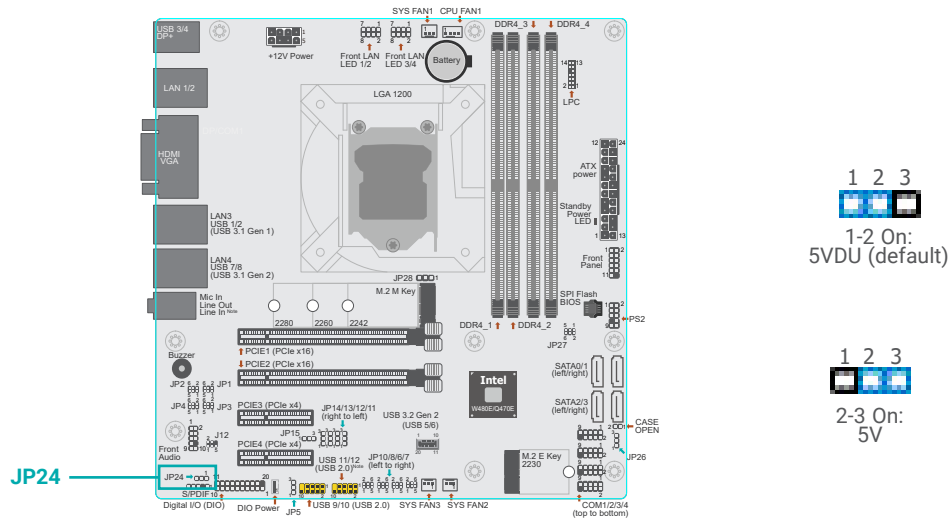

JP24 is used to determine the USB power.

► **Rear I/O Ports**

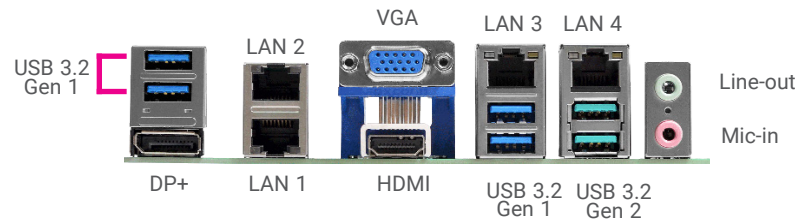

The rear panel I/O ports consist of the following:

- 1 DP++
- 2 USB 3.2 Gen2 ports
- RJ45 LAN 3/4
- 1 HDMI port
- 1 VGA port
- RJ45 LAN 1/2
- 4 USB 3.2 Gen 1 ports
- 1 Line-in jack (optional)
- 1 Line-out jack
- 1 Mic-in jack

► Rear I/O Ports

USB Ports

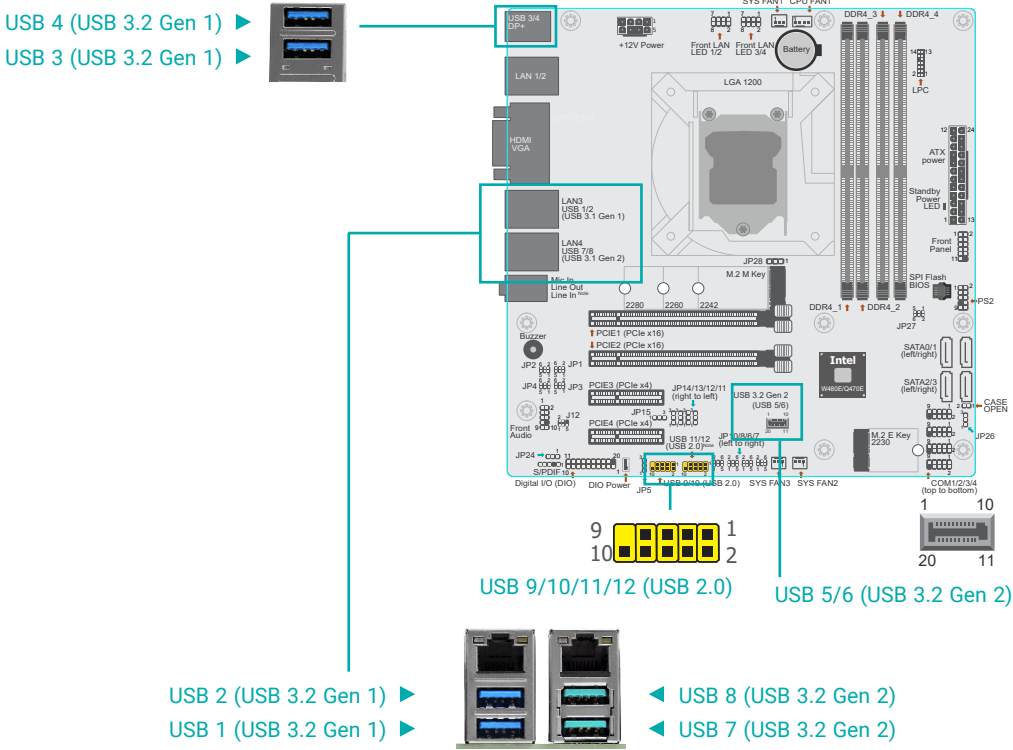

■ USB 2.0 Headers (USB 9/10/11/12)

Pin	Assignment	Pin	Assignment
1	SBV	2	SBV
3	Data-	4	Data-
5	Data+	6	Data+
7	GND	8	GND
9	---	10	N.C.

■ USB 3.2 Headers (USB 5/6)

Pin	Assignment	Pin	Assignment
10	SBV3	11	GND
9	Data-	12	Data-
8	Data+	13	Data+
7	GND	14	GND
6	Data-	15	Data-
5	Data+	16	Data+
4	GND	17	GND
3	Data-	18	Data-
2	Data+	19	Data+
1	GND	20	SBV3

The USB device allows data exchange between your computer and a wide range of simultaneously accessible external Plug and Play peripherals. The system board is equipped with multiple USB ports as listed below:

- 4 x USB 3.2 Gen 1 rear ports (USB 1/2/3/4)
- 2 x USB 3.2 Gen 2 rear ports (USB 7/8)
- 2 x USB 3.2 Gen 2 internal ports (USB 5/6)
- 4 x USB 2.0 internal ports, box headers (USB 9/10/11/12)

The internal USB ports may be mounted on a card-edge bracket. Install the card-edge bracket to an available slot at the rear of the system chassis and then insert the USB port cables to a connector.

Wake-On-USB Keyboard/Mouse

The Wake-On-USB Keyboard/Mouse function allows you to use a USB keyboard or USB mouse to wake up a system from the S3 (STR - Suspend To RAM) state.

► **Rear I/O Ports**

Graphics Interfaces

The display ports consist of the following:

- 1 DP++ Port
- 1 HDMI port
- 1 VGA port

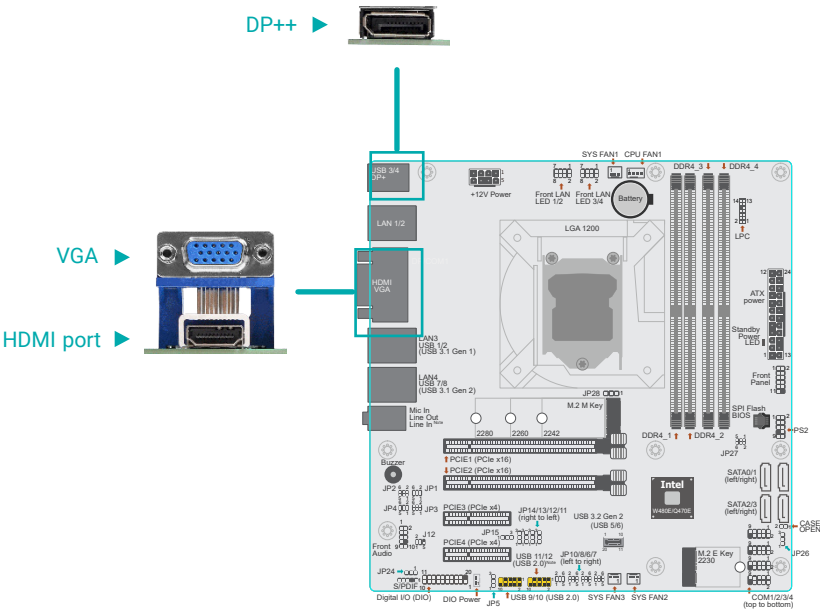

DP++ Port

The DP++ port which carries both digital audio and video signals is used to connect a LCD monitor or a digital TV that has the DP++ port.

HDMI Port

The HDMI port which carries both digital audio and video signals is used to connect a LCD monitor or digital TV that has the HDMI port.

VGA Port

The VGA port is used for connecting a VGA monitor. Connect the monitor's 15-pin D-shell cable connector to the VGA port. After you plug the monitor's cable connector into the VGA port, gently tighten the cable screws to hold the connector in place.

► Rear I/O Ports

RJ45 LAN Ports

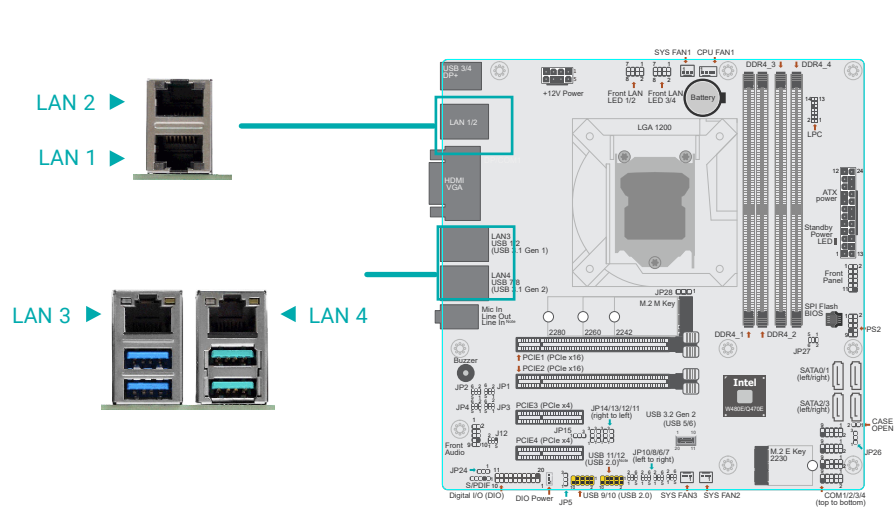

Features

- 2 x GbE (RJ-45) or
- 4 x GbE (RJ-45) (opt. by request, MOQ required)

The LAN ports allow the system board to connect to a local area network by means of a network hub.

► Rear I/O Ports

Audio

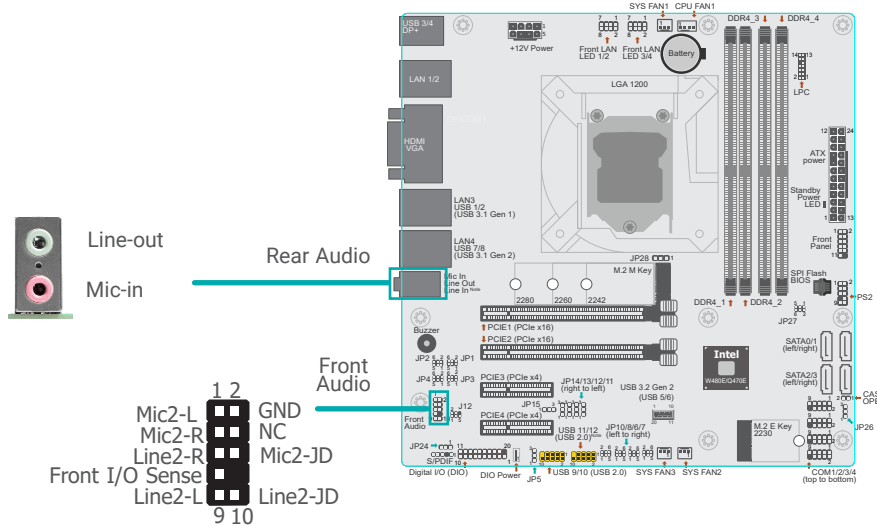

Rear Audio

The system board is equipped with 2 audio jacks (Line-out and Mic-in). Line-in jack is available upon request. A jack is a one-hole connecting interface for inserting a plug.

- Optional Line-in Jack (Light Blue)
- This jack is used to connect any audio devices such as Hi-fi set, CD player, tape player, AM/FM radio tuner, synthesizer, etc.
- Line-out Jack (Lime)
- This jack is used to connect a headphone or external speakers.
- Mic-in Jack (Pink)
- This jack is used to connect an external microphone.

Front Audio

The front audio connector allows you to connect to the second line-out and mic-in jacks that are at the front panel of your system.

Internal I/O Connectors

SATA (Serial ATA)

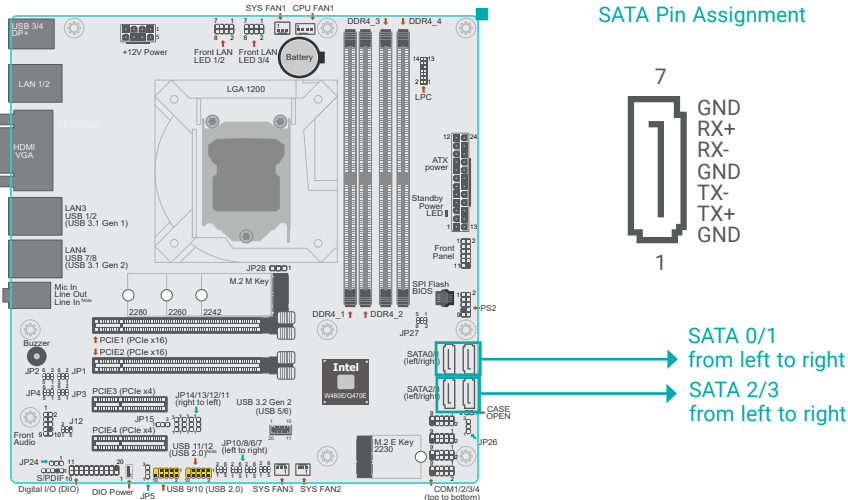

The Serial ATA (SATA) connectors are used to connect the Serial ATA device. SATA 3.0 is supported by the five SATA ports and provides data rate up to 6Gb/s. Connect one end of the Serial ATA cable to a SATA connector and the other end to your Serial ATA device.

Features

- 4 Serial ATA 3.0 ports with data transfer rate up to 6Gb/s
- Integrated Advanced Host Controller Interface (AHCI) controller
- Support RAID 0, RAID 1, RAID 5, RAID 10

Internal I/O Connectors

Digital I/O Connector (2.0mm pitch)

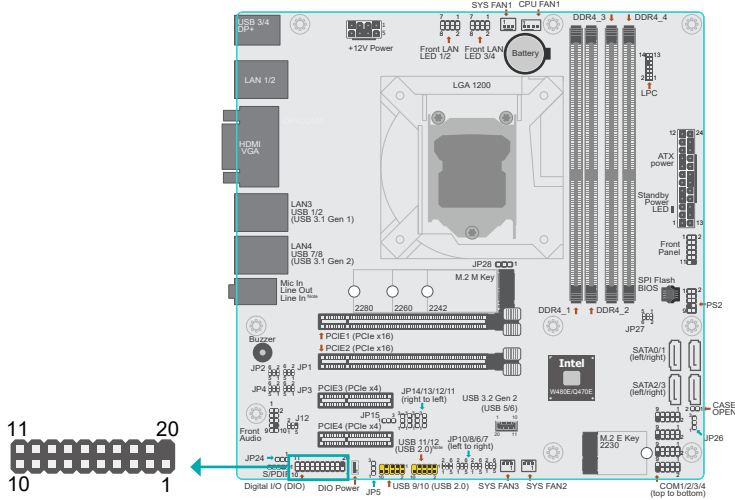

The 16-bit Digital I/O connector provides powering-on function to external devices that are connected to these connectors. The pin functions of the 16-bit digital I/O connector are listed below.

Pin	Assignment	Pin	Assignment
10	D_IOA0_C	11	D_IOA8_C
9	D_IOA1_C	12	D_IOA9_C
8	D_IOA2_C	13	D_IOA10_C
7	D_IOA3_C	14	D_IOA11_C
6	D_IOA4_C	15	D_IOA12_C
5	D_IOA5_C	16	D_IOA13_C
4	D_IOA6_C	17	D_IOA14_C
3	D_IOA7_C	18	D_IOA15_C
2	GND	19	GND
1	GND	20	---

► Internal I/O Connectors

COM (Serial) ports

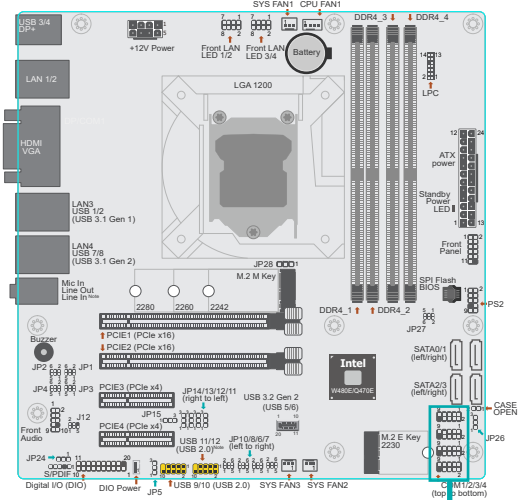

■ COM Port Pin Assignment

Pin	RS232	RS232 with PWR	RS422	RS485
1	DCD-	+12V	TXD-	Data-
2	SIN-	RD	TXD+	Data+
3	SO-	TD	RXD+	---
4	DTR-	DTR-	RXD-	---
5	GND	GND	GND	GND
6	DSR-	DSR-	---	---
7	RTS-	RTS-	---	---
8	CTS-	CTS-	---	---
9	RI-	5V	---	---

The pin functions of COM 1 port will vary according to setting of JP1, JP2, JP3 and JP4. Refer to “COM1/COM2 RS232/422/485 Select” and “COM1/COM2 RS232/Power Select” in this chapter for more information.

The pin functions of COM 2 port will vary according to setting of JP6, JP7, JP8 and JP10. Refer to “COM1/COM2 RS232/422/485 Select” and “COM1/COM2 RS232/Power Select” in this chapter for more information.

Connecting External Serial Ports

Your COM port may come mounted on a card-edge bracket. Install the card-edge bracket to an available slot at the rear of the system chassis then insert the serial port cable to the COM connector. Make sure the colored stripe on the ribbon cable is aligned with pin 1 of the COM connector.

► Internal I/O Connectors

Cooling Fan Connectors

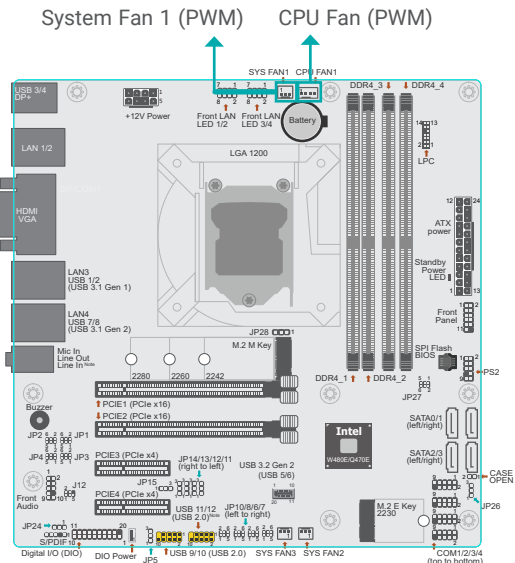

■ CPU Fan



■ System Fan

These fan connectors are used to connect cooling fans. The cooling fans will provide adequate airflow throughout the chassis to prevent overheating the CPU and system board components.

BIOS Setting

Configure the cooling fans in the Advanced menu (“NCT6106D HW Monitor” > “Smart Fan Function” submenu) of the BIOS. Refer to the chapter 3 for more information.

■ 4-pin Fan Pin Assignment

Pin	Assignment
1	Ground
2	12V
3	RPM
4	Control

■ 3-pin Fan Pin Assignment

Pin	Assignment
1	GND
2	PWM (12V)
3	TACH

► Internal I/O Connectors

Power Connector

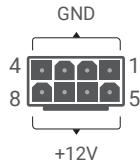

■ ATX 8-pin Power Connectors

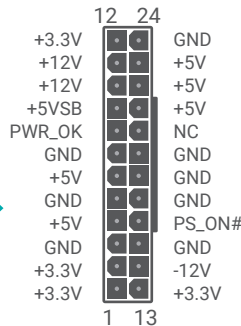
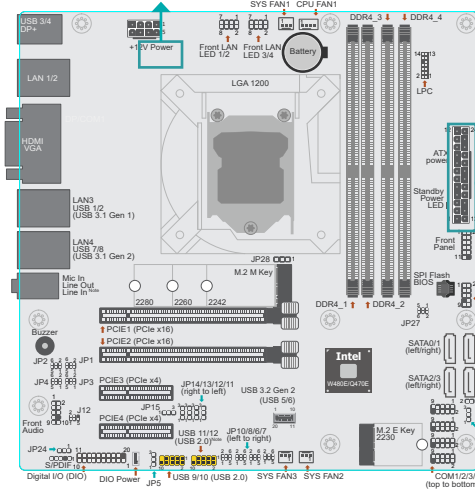

■ ATX 24-pin Power Connector

Use a power supply that complies with the ATX12V Power Supply Design Guide Version 1.1. An ATX12V power supply unit has a standard 24-pin ATX main power connector that must be inserted into the 24-pin connector. The 8-pin +12V power connector enables the delivery of more +12VDC current to the processor’s Voltage Regulator Module (VRM).

The power connectors from the power supply unit are designed to fit the 24-pin and 8-pin connectors in only one orientation. Make sure to find the proper orientation before plugging the connectors.

The system board requires a minimum of 300 Watt power supply to operate. Your system configuration (CPU power, amount of memory, add-in cards, peripherals, etc.) may exceed the minimum power requirement. To ensure that adequate power is provided, we strongly recommend that the system is supplied with a minimum of 400 Watt power.



Important:

Insufficient power supplied to the system may result in instability or malfunction of the add-in boards and peripherals. Calculating the system’s approximate power usage is important to ensure that the power supply meets the system’s consumption requirements.

► **Internal I/O Connectors**

Front Panel

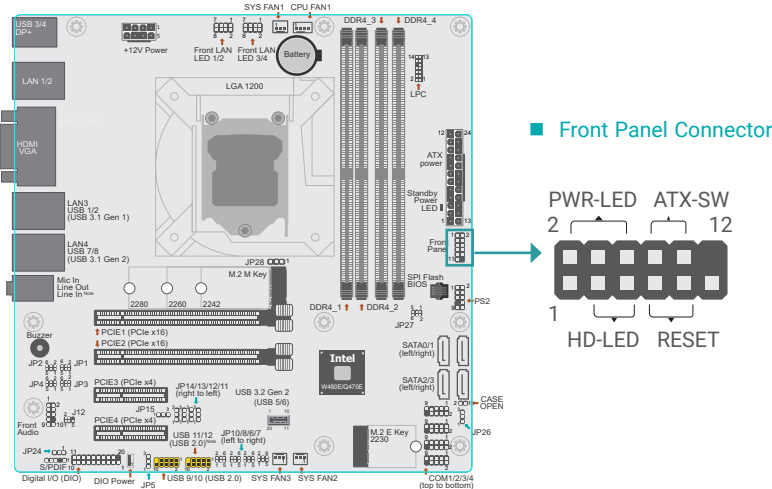

■ **Front Panel Pin Assignment**

	Pin	Assignment		Pin	Assignment
	1	N.C.		2	3V3SB
HD-LED	3	3V3	PWR-LED	4	3V3SB
	5	HD_LED		6	SUS_LED
RESET	7	Ground	ATX-SW	8	Ground
	9	PM_SYSRST		10	PWR_BTN-
	11	N.C.		12	--

HDD LED - Hard Disk Drive LED

Lighting of the LED indicates that the hard drive is being accessed.

RESET - Reset Switch

This switch allows you to reboot without having to power off the system.

Power/Standby LED

When the system's power is on, this LED will light up. When the system is in the S1 (POS - Power On Suspend) state, it will blink at 1-second intervals. When the system is in the S3 (STR - Suspend To RAM) state, it will blink at 4-second intervals.

Power Button

This button is used to switch the system's power on or off .

Internal I/O Connectors

LAN LED Connector

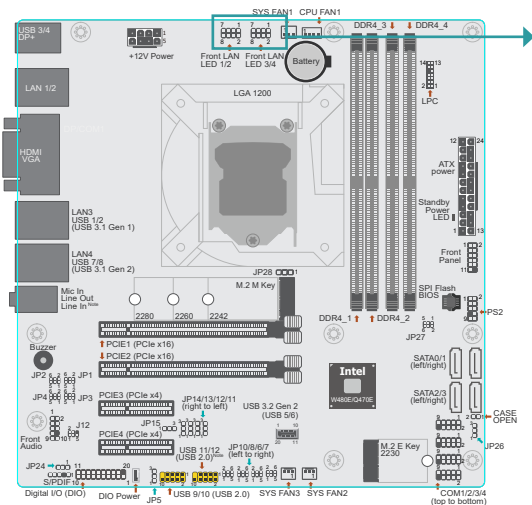

LAN LED 1/2, 3/4

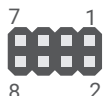

The LAN LED connector is used to detect the connection state of RJ45 LAN ports when the connection is made to an active network via a cable. The pin functions of the LAN LED connector are listed below.

- LAN1 PIN1/2/3/4
- LAN2 PIN5/6/7/8
- LAN3 PIN5/6/7/8
- LAN4 PIN1/2/3/4

LAN LED Connector Pin Assignment

Pin	Assignment	Pin	Assignment
1	LINK_1000	2	LINK_100
3	LINK_ACTIVITY	4	3V3_LAN
5	GBE_LED_1000-	6	GBE_LED_100-
7	GBE_LED_LINK_ACT-	8	3V3_LAN

Internal I/O Connectors

S/PDIF Connector

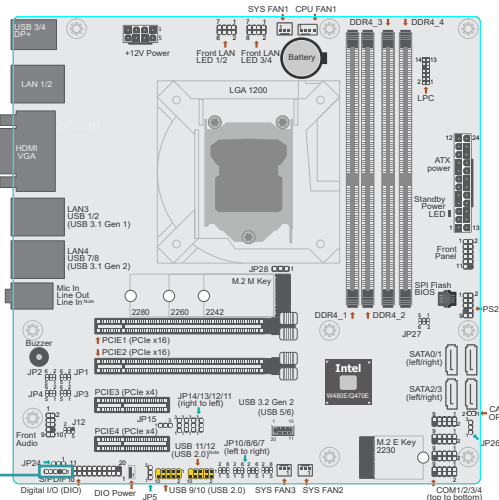

S/PDIF

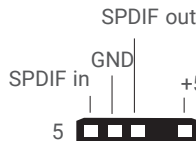

The S/PDIF connector is used to connect an external S/PDIF port. Your S/PDIF port may be mounted on a card-edge bracket. Install the card-edge bracket to an available slot at the rear of the system chassis then connect the audio cable to the S/PDIF connector. Make sure pin 1 of the audio cable is aligned with pin 1 of the S/PDIF connector.

Internal I/O Connectors

SMBus Connector

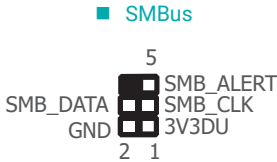
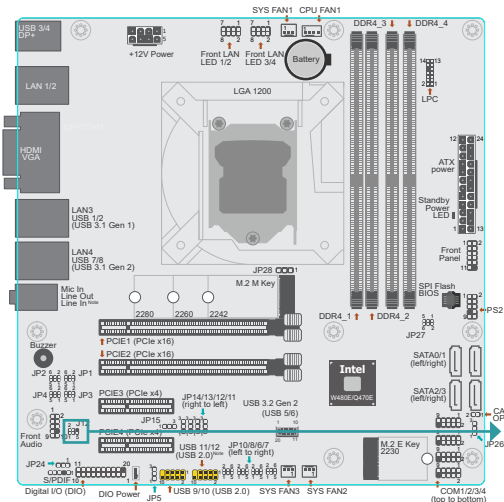

The SMBus (System Management Bus) connector is used to connect SMBus devices. It is a multiple device bus that allows multiple chips to connect to the same bus and enable each one to act as a master by initiating data transfer.

Internal I/O Connectors

LPC Connector

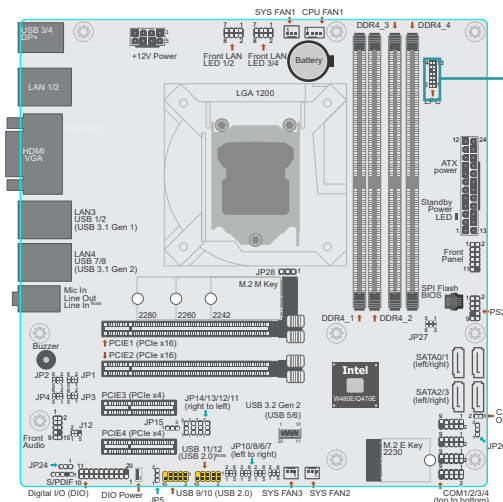

■ LPC Connector

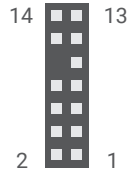

The Low Pin Count Interface was defined by Intel® Corporation to facilitate the industry's transition towards legacy free systems. It allows the integration of low-bandwidth legacy I/O components within the system, which are typically provided by a Super I/O controller. Furthermore, it can be used to interface firmware hubs, Trusted Platform Module (TPM) devices and embedded controller solutions. Data transfer on the LPC bus is implemented over a 4 bit serialized data interface, which uses a 33MHz LPC bus clock. For more information about LPC bus refer to the Intel® Low Pin Count Interface Specification Revision 1.1'. The table below indicates the pin functions of the LPC connector.

Pin	Assignment	Pin	Assignment
1	CLK	2	L_AD1
3	RST#	4	L_AD0
5	FRAME#	6	VCC3
7	LAD3	8	GND
9	LAD2	10	---
11	SERIRQ	12	GND
13	5V5B	14	5V

Internal I/O Connectors

PS2

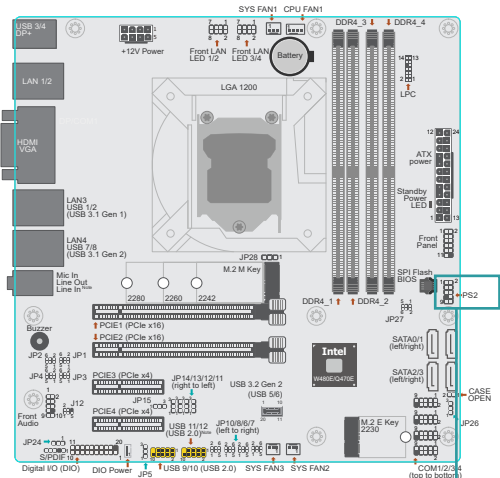

■ PS2 Pin Assignment

Pin	Assignment	Pin	Assignment
1	KCLK	2	MCLK
3	KDAT	4	MDAT
5	GND	6	GND
7	---	8	GND
9	GND	10	GND



Internal I/O Connectors

Chassis Intrusion Connector

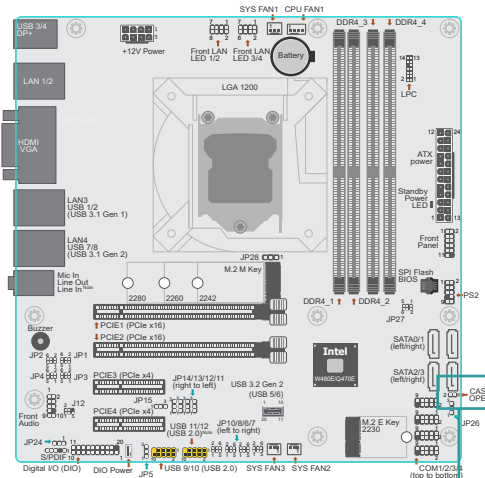

■ Chassis Intrusion Connector Pin Assignment

Pin	Assignment	Pin	Assignment
1	CASEOPEN-	2	GND



► Internal I/O Connectors

InnoAGE HDR1 (JP27)

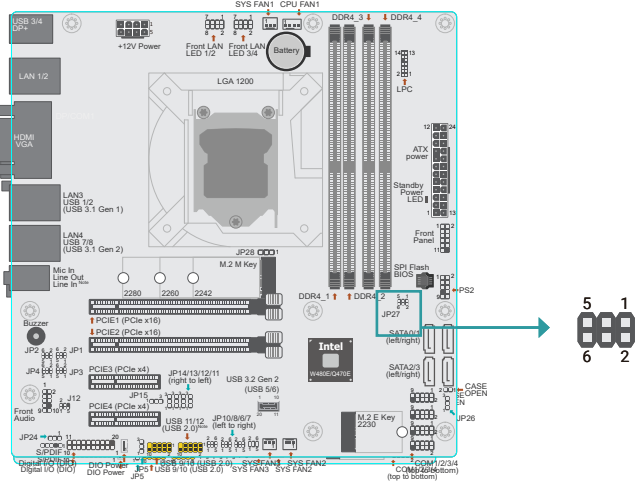

JP27 is used to set InnoAGE functions.
 *Note: Currently support InnoAge out-of-band management through RJ45 only.

■ **InnoAGE HDR1 (JP27)
 Pin Assignment**

Pin	Assignment	Pin	Assignment
1	PCRST#	2	RECOV#
3	PWRLED#	4	HDDLED#
5	PWRBTN#	6	GND

Internal I/O Connectors

Expansion Slots

- a PCIe 1 (PCIe x16)
- b PCIe 2 (PCIe x16)
- c PCIe 3 (PCIe x4)
- d PCIe 4 (PCIe x4)
- e M.2-M
- f M.2-E

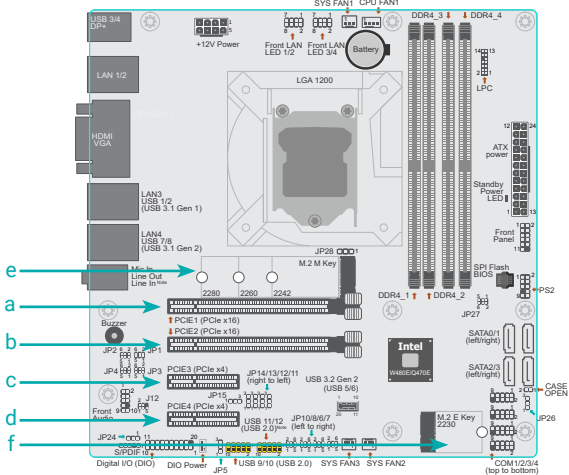

PCI Express x16 Slot

Install a PCI Express x16 graphics card that complies to the PCI Express specifications into the PCI Express x16 slot. To install a graphics card into the x16 slot, align the graphics card to the socket and perpendicularly to the board, be cautious in aligning the locations of notch and key, and then press the card down firmly until it is completely seated. The retaining clip of the slot will close up automatically to hold the graphics card in place.

PCI Express x4 Slots

Install PCI Express cards such as network cards or other expansion cards

M.2 Socket

The M.2 socket is the Next Generation Form Factor (NGFF) which is designed to support multiple modules and make the M.2 more suitable in application for solid-state storage.

Internal I/O Connectors Expansion Slots

Installing the M.2 Module

Before installing the M.2 module into the M.2 socket, please make sure that the following safety cautions are well-attended.

- 1. Make sure the PC and all other peripheral devices connected to it has been powered down.
- 2. Disconnect all power cords and cables.
- 3. Locate the M.2 socket on the system board
- 4. Make sure the notch on card is aligned to the key on the socket.
- 5. Make sure the standoff screw is removed from the standoff.

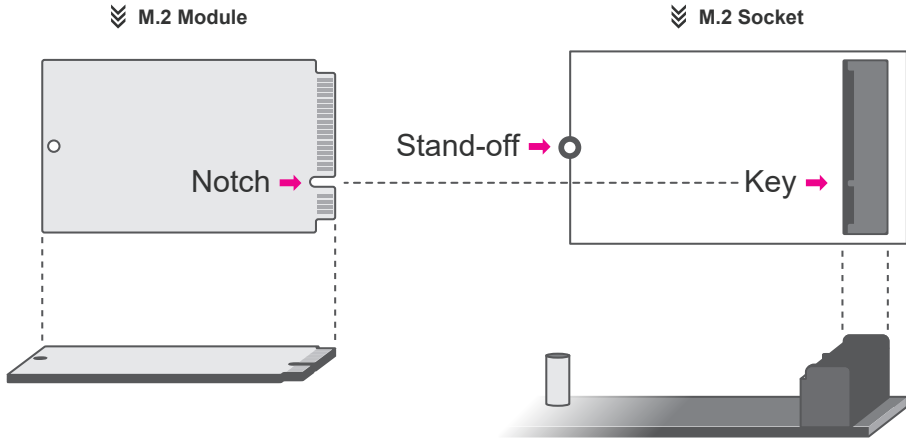

Please follow the steps below to install the card into the socket.

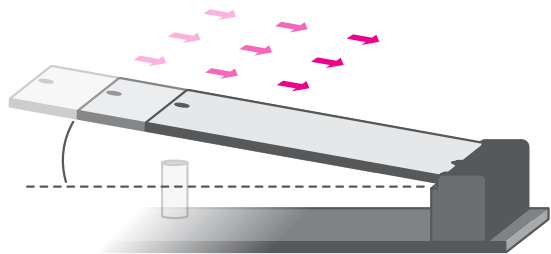

Step 1:
Insert the card into the socket at an angle while making sure the notch and key are perfectly aligned.

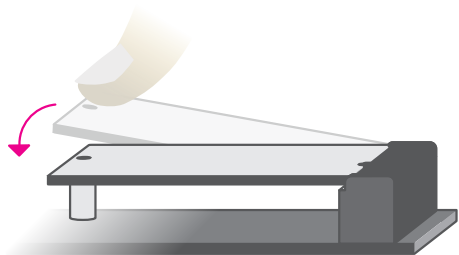

Step 2:
Press the end of the card far from the socket down until the gap between the card and the stand-off closes up.

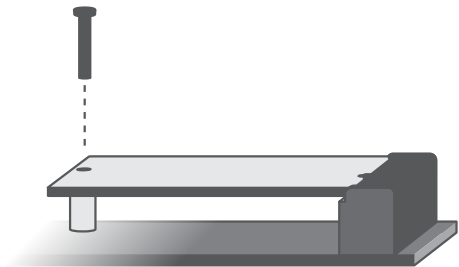

Step 3:
Screw tight the card onto the stand-off with a screw driver and a stand-off screw until the gap between the card and the stand-off closes up. The card should be lying parallel to the board when it's correctly mounted.

Battery

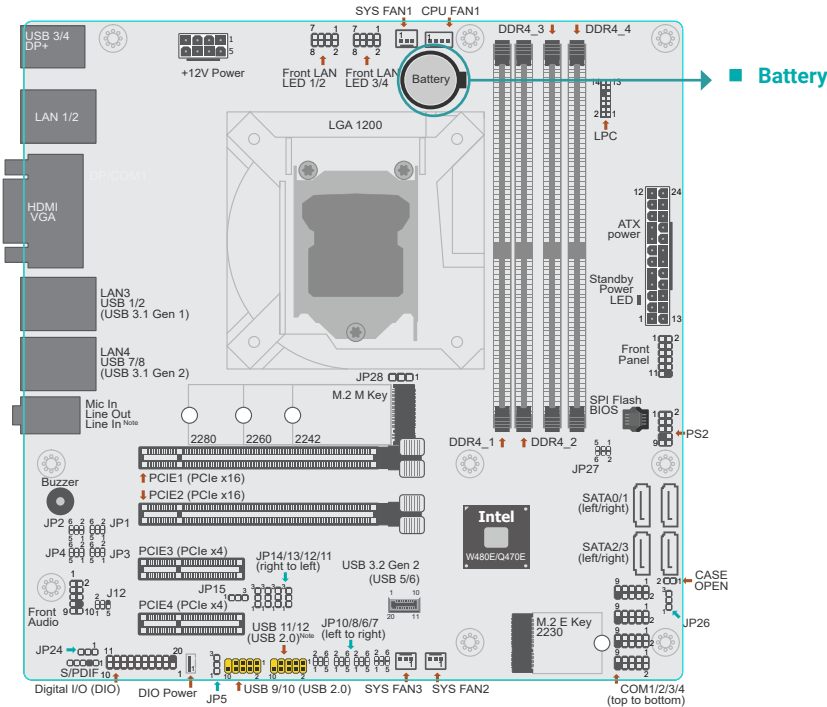

The lithium ion battery addendum supplies power to the real-time clock and CMOS memory as an auxiliary source of power when the main power is shut off. Insert a coin cell battery into the holder and make sure the polarities are correctly oriented – the cap side (rimmed rounded edge) is negative and should be facing the holder; the flat side with a + mark is positive and should be facing away from the holder.

Safety Measures

- There exists explosion hazard if the battery is incorrectly installed.
- Replace only with the same or equivalent type recommended by the manufacturer.
- Dispose of used batteries according to local ordinances.

Chapter 3 - BIOS Setup

► Overview

The BIOS is a program that takes care of the basic level of communication between the CPU and peripherals. It contains codes for various advanced features found in this system board. The BIOS allows you to configure the system and save the configuration in a battery-backed CMOS so that the data retains even when the power is off. In general, the information stored in the CMOS RAM of the EEPROM will stay unchanged unless a configuration change has been made such as a hard drive replaced or a device added.

It is possible that the CMOS battery will fail causing CMOS data loss. If this happens, you need to install a new CMOS battery and reconfigure the BIOS settings.



Note:

The BIOS is constantly updated to improve the performance of the system board; therefore the BIOS screens in this chapter may not appear the same as the actual one. These screens are for reference purpose only.

Default Configuration

Most of the configuration settings are either predefined according to the Load Optimal Defaults settings which are stored in the BIOS or are automatically detected and configured without requiring any actions. There are a few settings that you may need to change depending on your system configuration.

Entering the BIOS Setup Utility

The BIOS Setup Utility can only be operated from the keyboard and all commands are keyboard commands. The commands are available at the right side of each setup screen.

The BIOS Setup Utility does not require an operating system to run. After you power up the system, the BIOS message appears on the screen and the memory count begins. After the memory test, the message "Press DEL to run setup" will appear on the screen. If the message disappears before you respond, restart the system or press the "Reset" button. You may also restart the system by pressing the <Ctrl> <Alt> and keys simultaneously.

Legends

Keys	Function
Right / Left arrow	Move the highlight left or right to select a menu
Up / Down arrow	Move the highlight up or down between submenus or fields
<Enter>	Enter the highlighted submenu
+ (plus key)/F6	Scroll forward through the values or options of the highlighted field
- (minus key)/F5	Scroll backward through the values or options of the highlighted field
<F1>	Display general help
<F9>	Optimized defaults
<F10>	Save and Exit
<Esc>	Return to previous menu

Scroll Bar

When a scroll bar appears to the right of the setup screen, it indicates that there are more available fields not shown on the screen. Use the up and down arrow keys to scroll through all the available fields.

Submenu

When "►" appears on the left of a particular field, it indicates that a submenu which contains additional options are available for that field. To display the submenu, move the highlight to that field and press <Enter>.

► Main

The Main menu is the first screen that you will see when you enter the BIOS Setup Utility.

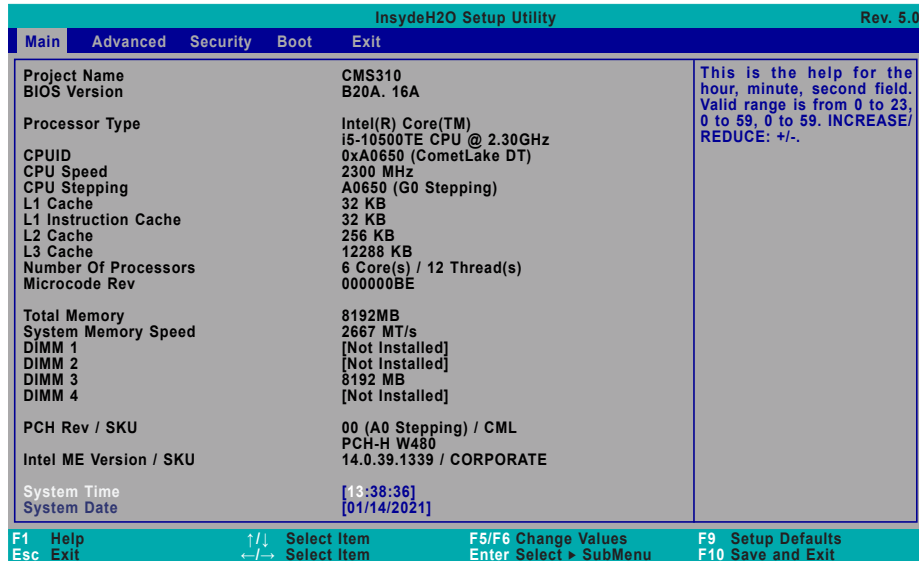

System Time

The time format is <hour>, <minute>, <second>. The time is based on the 24-hour military-time clock. For example, 1 p.m. is 13:00:00. Hour displays hours from 00 to 23. Minute displays minutes from 00 to 59. Second displays seconds from 00 to 59.

System Date

The date format is <month>, <date>, <year>. Month displays the month, from 01 to 12. Date displays the date, from 01 to 31. Year displays the year, from 2000 to 2099.

► Advanced

The Advanced menu allows you to configure your system for basic operation. Some entries are defaults required by the system board, while others, if enabled, will improve the performance of your system or let you set some features according to your preference.



Important:

Setting incorrect field values may cause the system to malfunction.

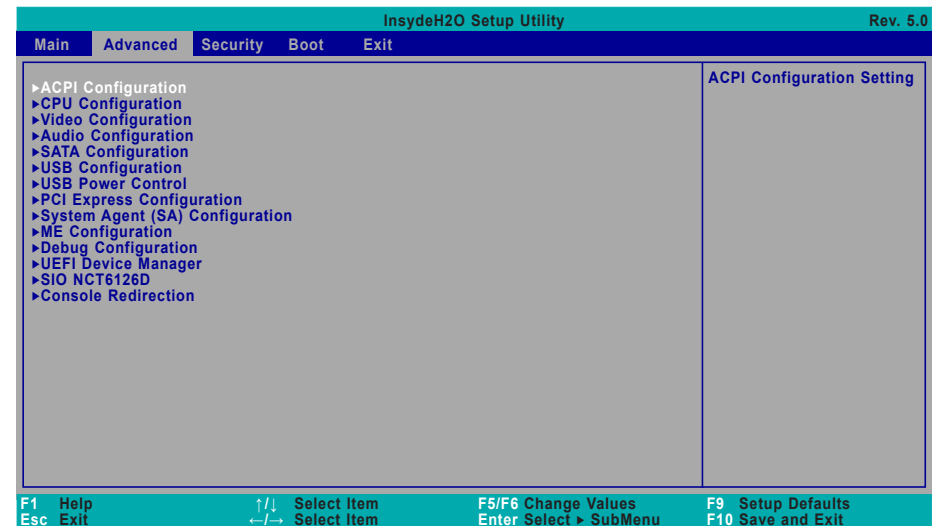

► Advanced

ACPI Configuration

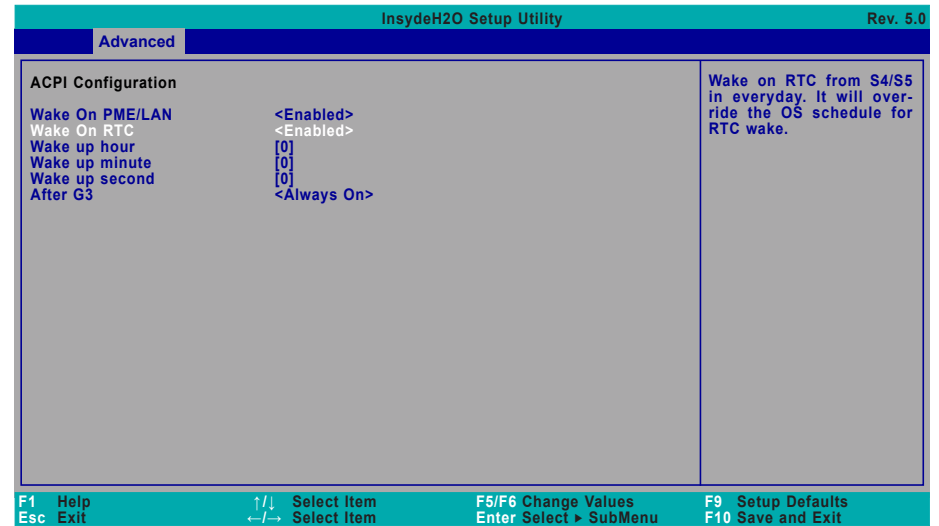
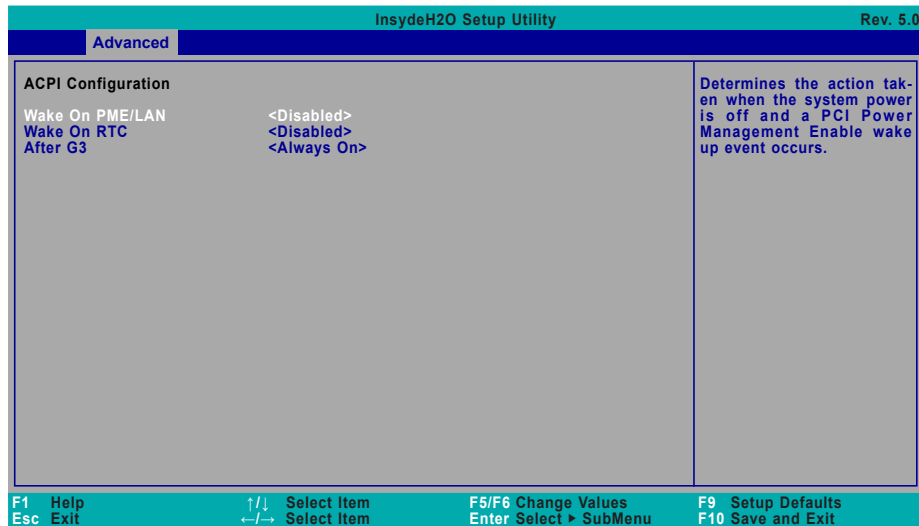

Wake On PME/LAN

Enable or Disable this field to allow LAN signal to power up the system.

Wake On RTC

When Enabled, the system will automatically wake up from S4/S5 state at a designated time every day via the Real-time clock (RTC) battery.

[Wake up hour/minute/second]

Configure the time of day the system will wake on RTC. This field will only appear when "Wake On RTC" is enabled.

After G3

This field is to specify what state the system should be in when power is re-applied after a power failure.

- **Always On** The system automatically powers on after power failure.
- **Always Off** The system remains power off after power failure. Power-on signal input is required to power up the system.
- **Last State** The system remains last state before power off after power failure.

▶ Advanced

CPU Configuration

Configure CPU processing related settings in this page.

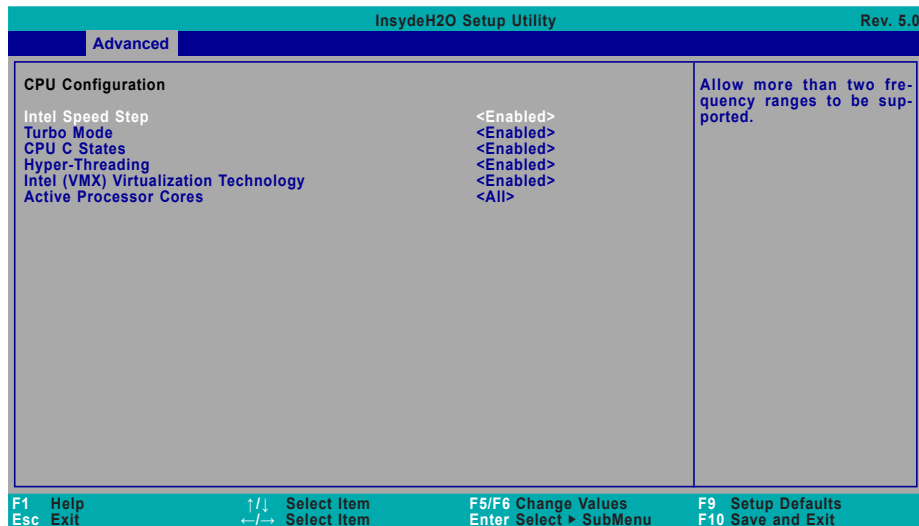

Intel Speed Step

This field is used to enable or disable the Intel Enhanced SpeedStep Technology. If enabled, Turbo Mode will appear for configuration.

Turbo Mode

Enable or disable the turbo mode.

CPU C States

Enable or disable the CPU Power Management.

Hyper-Threading

Enables this field for Windows XP and Linux which are optimized for Hyper-Threading technology. Select disabled for other OSes not optimized for Hyper-Threading technology. When disabled, only one thread per enabled core is enabled.

Intel (VMX) Virtualization Technology

When this field is set to Enabled, the VMM can utilize the additional hardware capabilities provided by Vanderpool Technology.

Active Processor Cores

Select number of cores to enable in each processor package.

▶ Advanced

Video Configuration

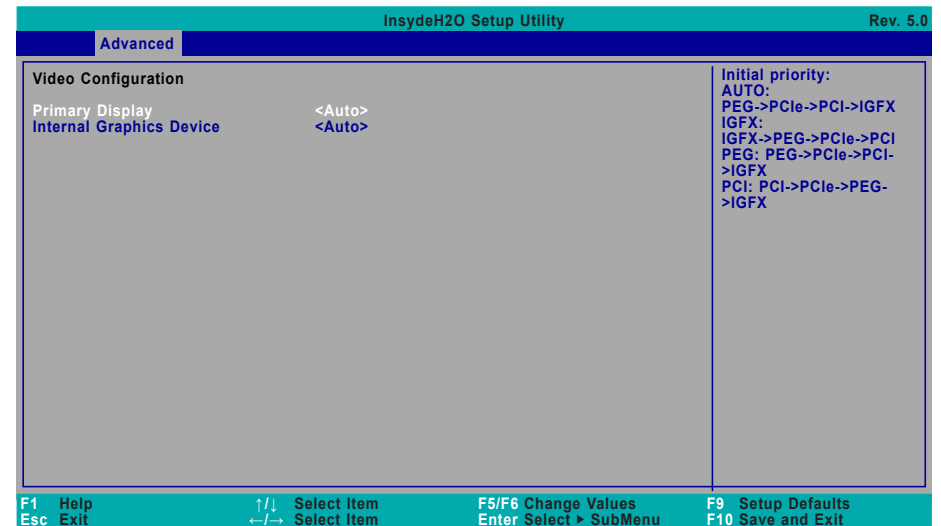

Primary Display

Set the initial priority of graphics devices.

Internal Graphics Device

Keep IGFX enabled or disabled based on the setup options.

► Advanced

Audio Configuration

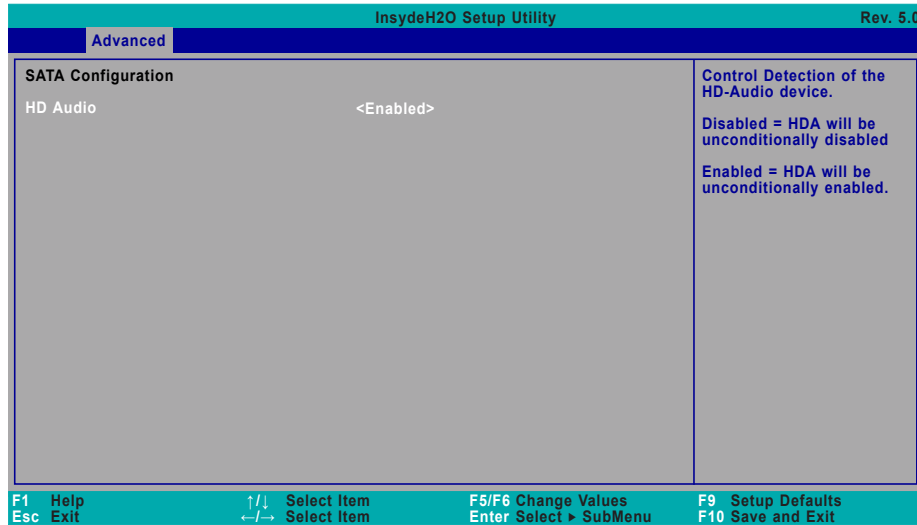

HD Audio

Control the detection of the HD-Audio device

- **Disabled** HDA will be unconditionally disabled
- **Enabled** HDA will be unconditionally enabled
- **Auto** HDA will be enabled if present, disabled otherwise

► Advanced

SATA Configuration

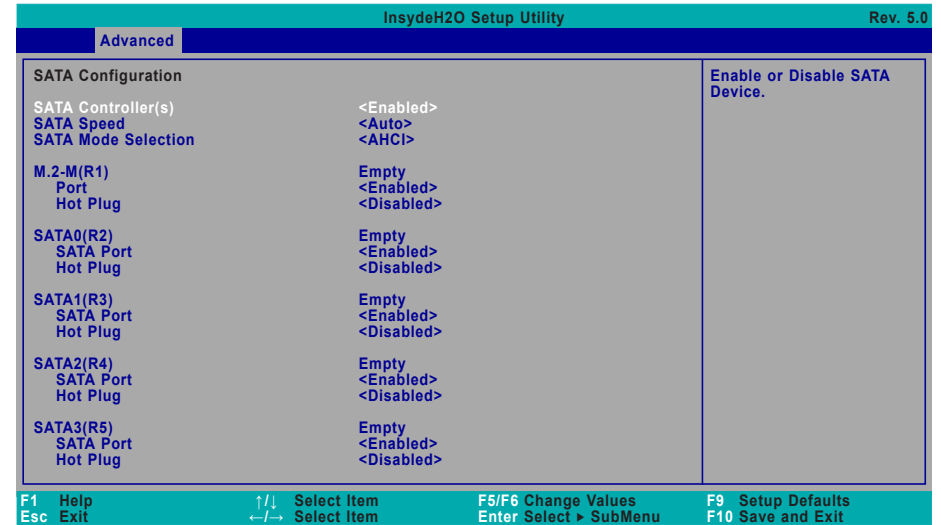

SATA Controller(s)

Enable or disable the Serial ATA controller. This following fields will only be displayed when this field is enabled.

SATA Speed

Select Serial ATA controller(s) speed – Auto, Gen1 (1.5 Gbit/s), Gen2 (3 Gbit/s) or Gen 3 (6 Gbit/s).

SATA Mode Selection

The mode selection determines how the SATA controller(s) operates.

- **AHCI** This option allows the Serial ATA controller(s) to use AHCI (Advanced Host Controller Interface).
- **RAID** This option allows the Serial ATA controller(s) to use UEFI, RAID, and Intel Rapid Storage Technology.

SATA Port 0-3/Hot Plug

Enable or disable each Serial ATA port and its hot plug function.

► Advanced

USB Configuration

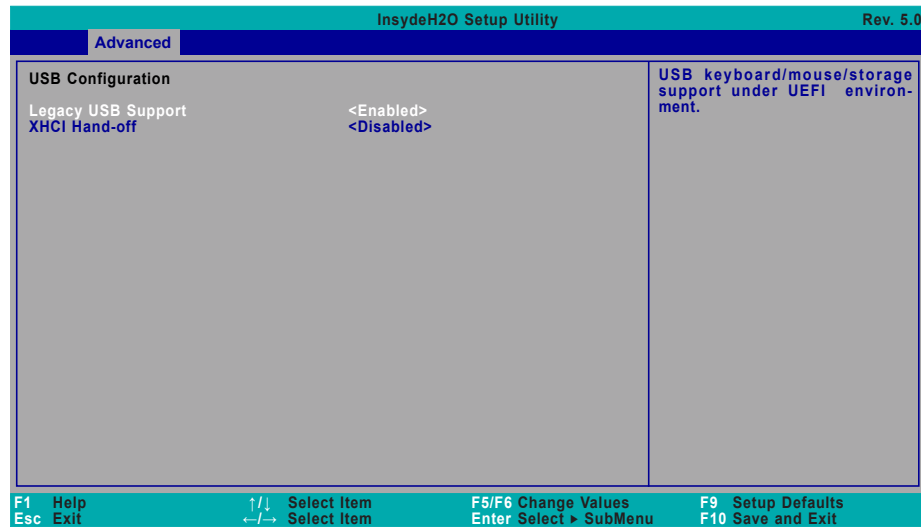

Legacy USB Support

- **Enabled** Enable Legacy USB support.
- **Disabled** Keep USB devices available only for EFI applications.

XHCI Hand-off

Enable or disable to clear XHCI controller ownership change SMI bit by BIOS.

► Advanced

USB Power Control

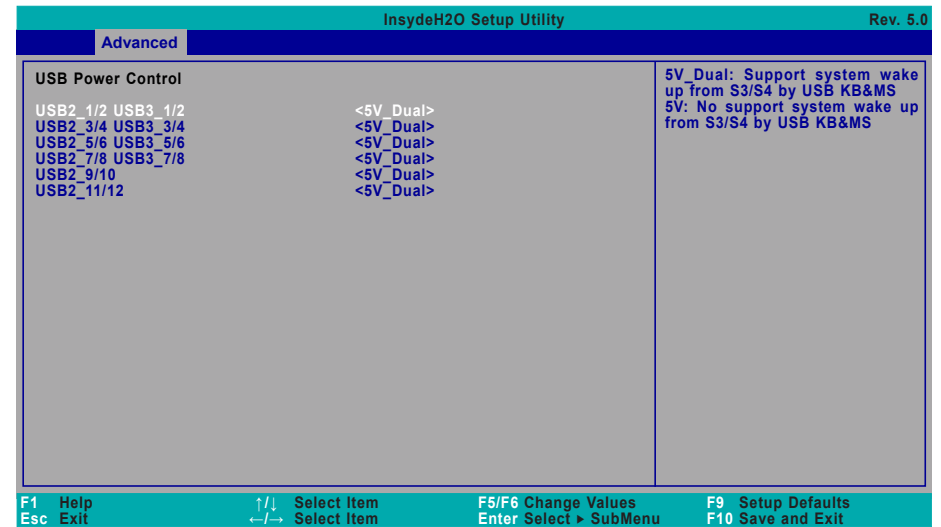

Decide USB Power to each port

To decide USB Power type to use in different scenerios.

5V_Dual supports system wake up from S3/S4 by USB keyboard and mouse, but 5V doesn't.

► **Advanced**

PCI Express Configuration

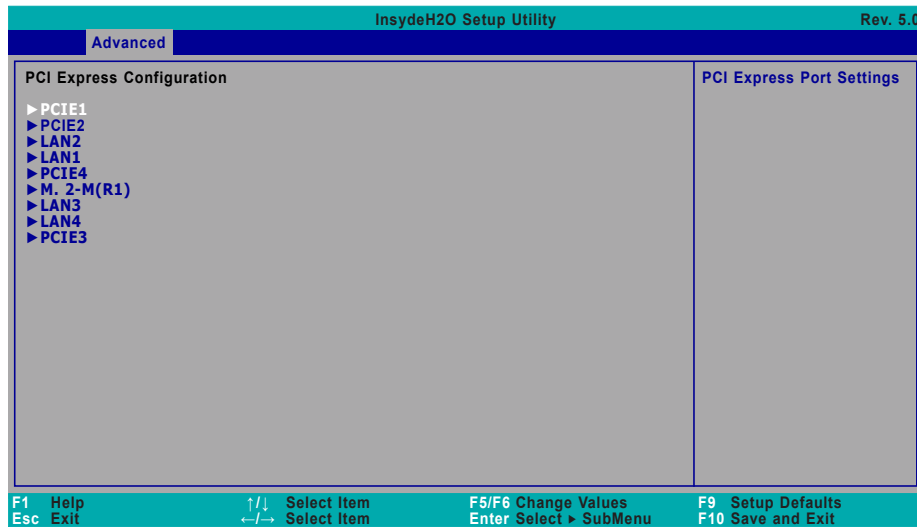

► **PCI E1/PCI E2**

Port Enable

Enable or disable the PCI Express Root Port.

PCIe Speed

Select PCIe Speed of the current port – AUTO, Gen1 (2.5 GT/s), Gen2 (5 GT/s), or Gen3 (8 GT/s).

► **LAN2/LAN1**

Port Enable

Enable or disable the LAN Port.

► **PCI E4/M.2-M(R1)/LAN3/LAN4/PCI E3**

Port Enable

Enable or disable the PCI Express Root Port, LAN Port and M.2-M.

PCIe Speed

Select PCIe Speed of the current port – AUTO, Gen1 (2.5 GT/s), Gen2 (5 GT/s), or Gen3 (8 GT/s). Gen 3 is only available for the PCI E1 port. This field may not appear when the speed of the port is not configurable.

Hot Plug

Enable or disable hot plug function of the port. This field may not appear when the port does not support hot plug.

▶ Advanced

System Agent (SA) Configuration

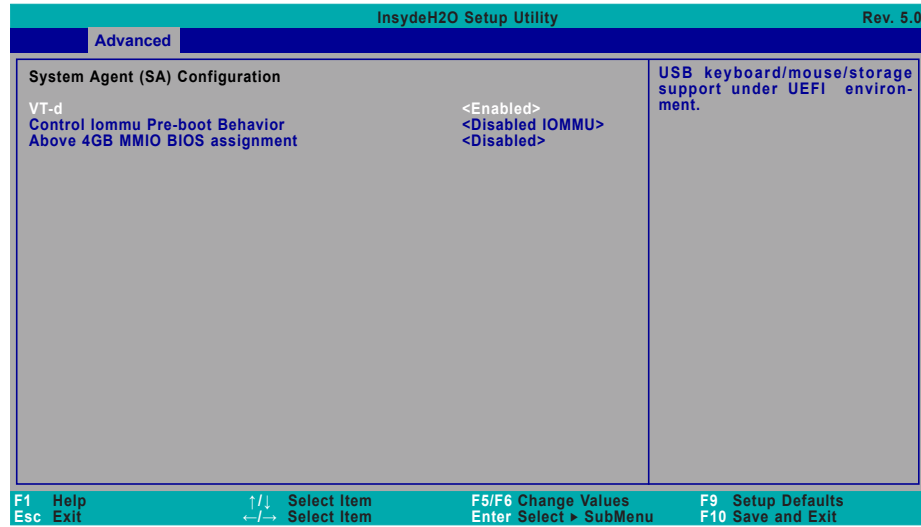

VT-d

Enable or disable VT-d capability

Control Iommu Pre-boot Behavior

Enable or disable dTBT and PCH USB topology IOMMU in Pre-boot environment.

Above 4GB MMIO BIOS assignment

Switch MemoryMappedIO BIOS assignment above 4GB.

▶ Advanced

ME Configuration

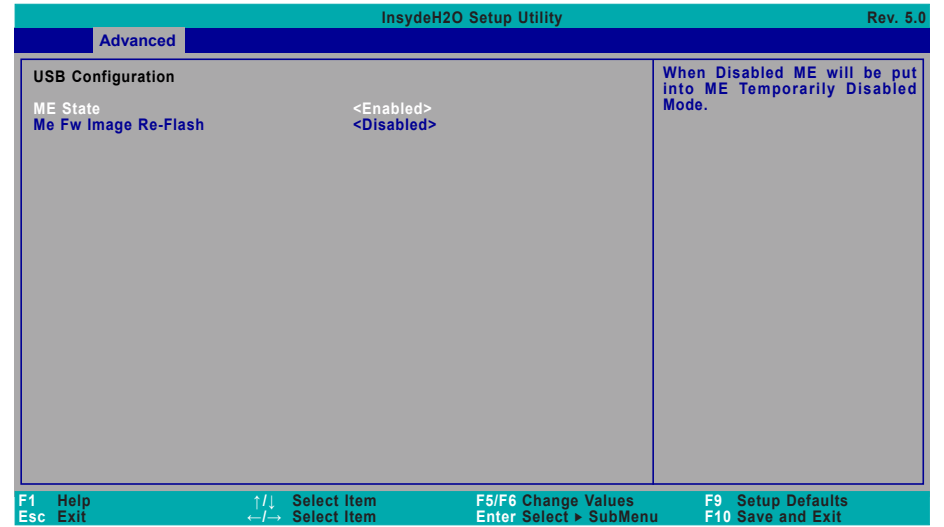

ME State

When this field is set to Disabled, ME will be put into ME Temporarily Disabled Mode.

Me Fw Image Re-Flash

This field is used to enable or disable the flash ME region.

► Advanced

Debug Configuration

This section configures Debug setting.

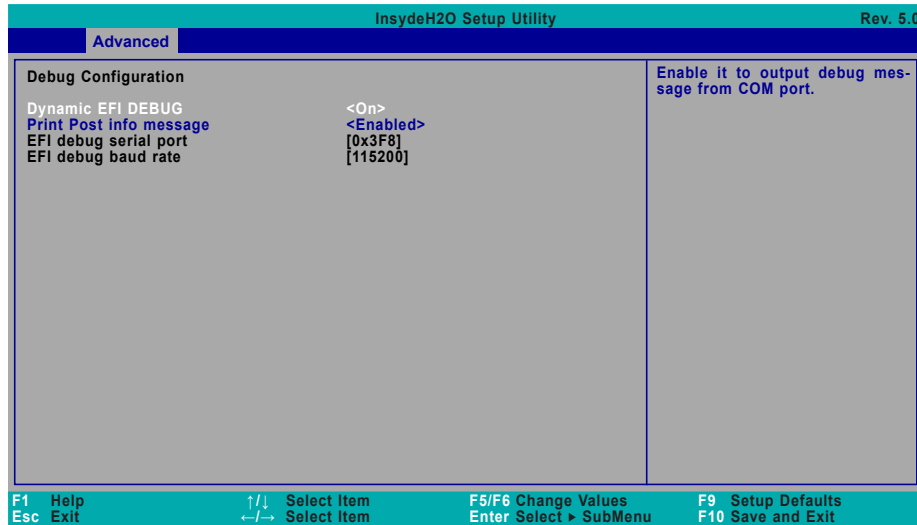

Dynamic EFI DEBUG

This field is used to turn on or off the function to output debug message from COM port. When this field is set to "On", the following EFI debug configurations will be displayed.

Print Post info message

Informational debug message will be output to COM port.

EFI debug serial port

Enter serial port to output EFI debug message and default is 0x3F8

EFI debug baud rate

Enter the baud rate to output EFI debug message. The default is 115200.

► Advanced

UEFI Device Manager

Configure UEFI device with option ROM, such as LAN card, etc.

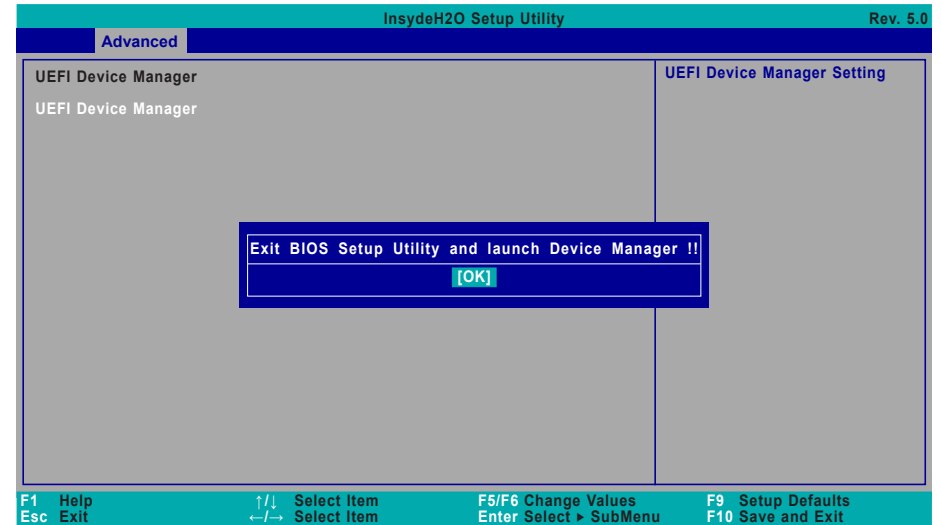

Press "Enter" and "OK" to enter UEFI Device Manager setup page. More device settings can be configured in the UEFI Device Manager, including LAN, Network Stacks, and etc.



Note:

Network Device will not be configurable in Device Manager if "Network Stack" is disabled in the "Boot" menu.

► **Advanced**

SIO NCT6126D

Configure Super I/O settings in this submenu. Scroll by moving the cursor up or down to reveal more options.

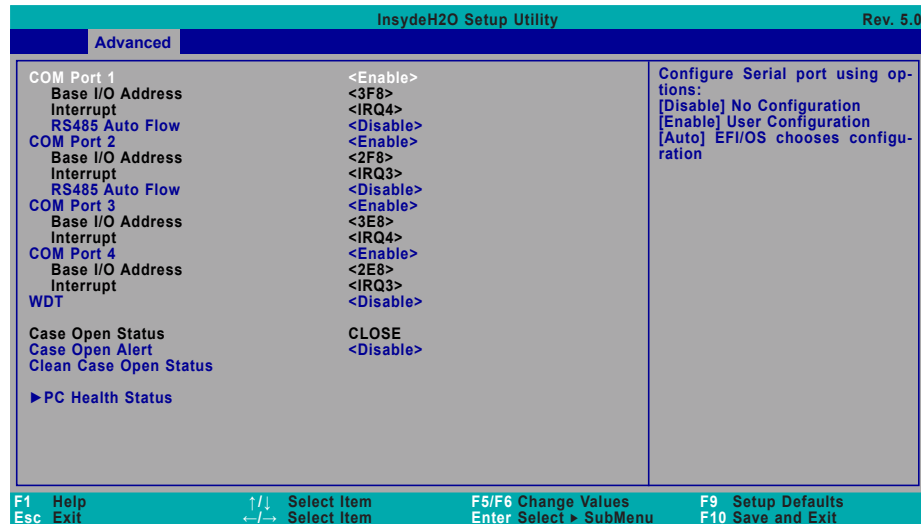

COM Port 1/2

Enables or disables the serial ports (COM). The following bracketed fields will only appear when the port is enabled.

COM Port 3/4

Enables or disables the serial ports (COM). The following bracketed fields will only appear when the port is enabled.

WDT

Enable or disable the Watchdog Timer (WDT) function. A counter will appear if you select to enable WDT. Input any value between 1 to 255 seconds.

▼ **WDT = [Enable]**

Case Open Alert

Enable or disable case open alert.

Clean Case Open Status

Clean current case open status including alert.

▶ PC Health Status

This section displays the PC health status.

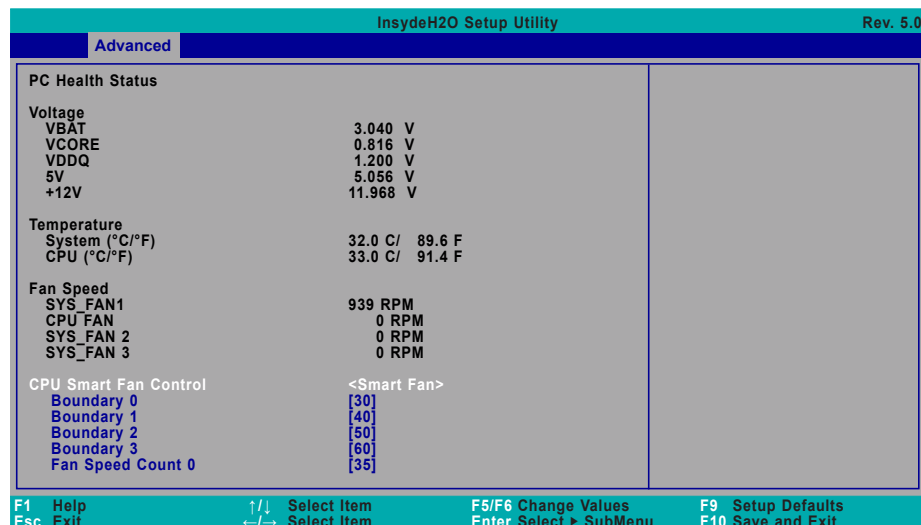

Smart Fan

Smart Fan is a fan speed moderation strategy that depends on the current system temperature. When the system temperature goes higher than the Boundary setting, the fan speed will be turned up to the setting of the Fan Speed Count that bears the same index as the Boundary field.

SYS Smart Fan/CPU Smart Fan Control

Enable or disable the system smart fan. When disabled, fan speed will not be controllable according to different system temperatures. Instead, a Fix Fan Speed Count field will be displayed to configure at which speed the fan will always be fixed regardless of system temperature.

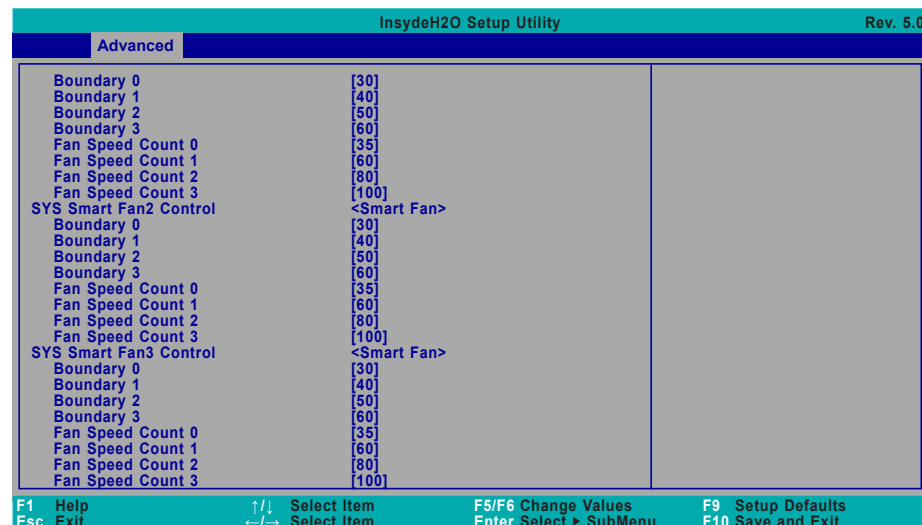

▼ CPU / Sytem Fan Mode = [Smart Fan]

Boundary 0 to Boundary 3

Set the boundary temperatures that determine the fan speeds accordingly, the value ranging from 0-127°. For example, when the system temperature reaches Boundary 1 setting, the fan speed will be turned up to the designated speed of the Fan Speed Count 1 field.

Fan Speed Count 0 to Fan Speed Count 3

Set the fan speed, the value ranging from 1-100%, 100% being full speed. The fans will operate according to the specified boundary temperatures above-mentioned.

▼ CPU / System Fan Mode = [Manual]

Fan Speed Count

Set the fan speed, the value ranging from 1-100%, 100% being full speed. The fans will always operate at the specified speed regardless of gauged temperatures.

► **Advanced**

Console Redirection

Configure COM port serial settings in the submenu.

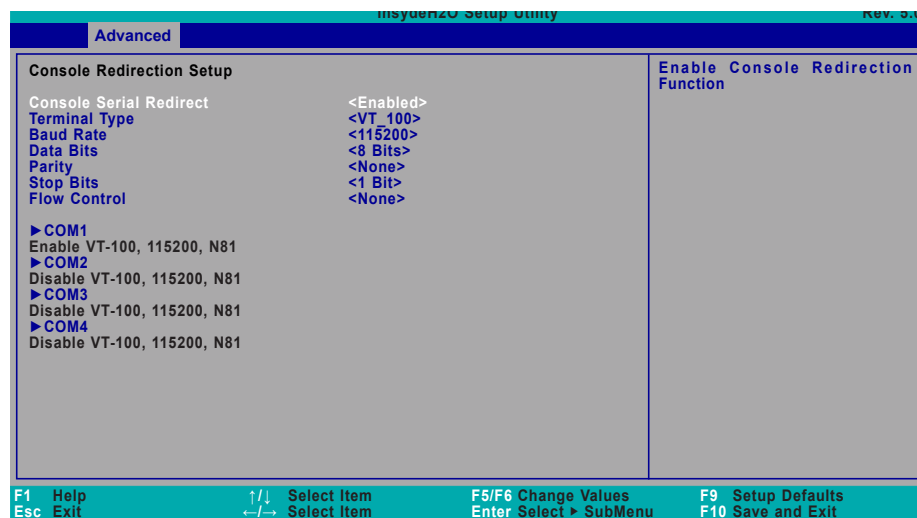

Console Serial Redirect

Enable or disable Console Serial Redirect.

Terminal Type

Select terminal type – VT_100, VT_100+, VT_UTF8 or PC_ANSI.

Baud Rate

Select baud rate – 115200, 57600, 38400, 19200, 9600, 4800, 2400 or 1200.

Data Bits

Select data bits – 7 bits or 8 bits.

Parity

Select parity bits – none, even or odd.

Stop Bits

Select stop bits – 1 bit or 2 bits.

Flow Control

Select flow control type – none, RTS/CTS or XON/XOFF.

► **COM1/COM2/COM3/COM4**

Configure individual COM port serial settings in the submenu.

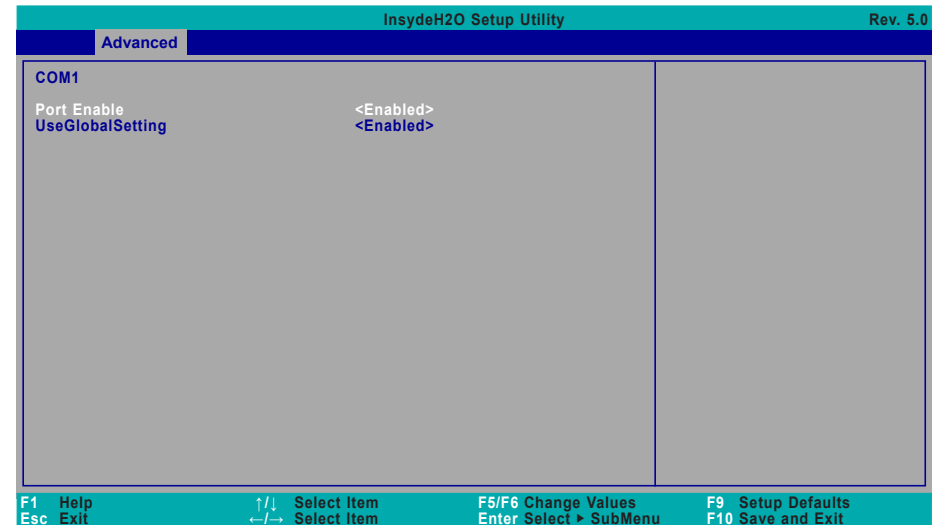

Port Enable

This field is used to enable or disable the COM port to redirect the console.

Use Global Setting

This field is to enable or disable using the global setting. When "Use Global Setting" is enabled, settings of the current port will dependent on Console Redirection settings. When "Use Global Setting" is disabled, settings of the current port can be configured independently in this section.

► Security

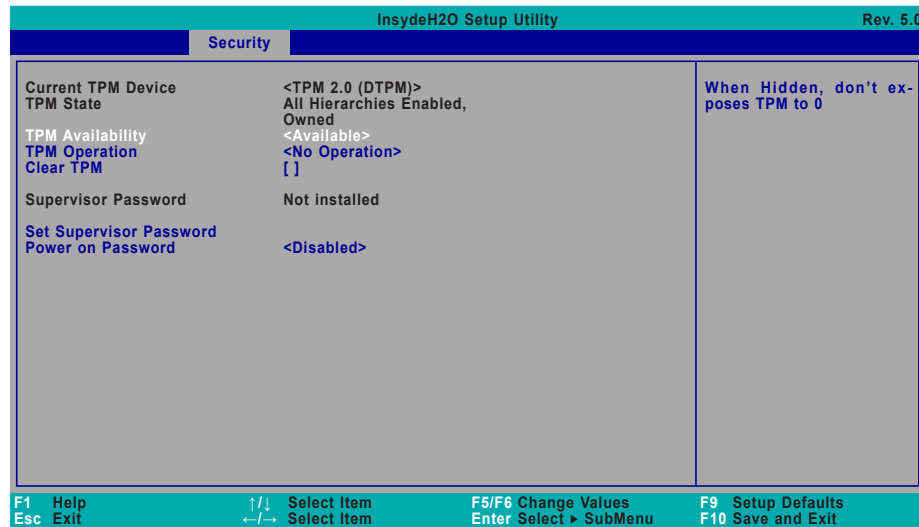

TPM Availability

Show or hide the TPM availability and its configurations.

TPM Operation

Select one of the supported operation to change TPM2 state – No Operation, Enable, or Disable.

Clear TPM

Remove all TPM context associated with a specific Owner.

Set Supervisor Password

Set the supervisor's password. The length of the password must be greater than one character.



Note:
The devices shown here are based on a carrier board that may not resemble your actual carrier board. The actual I/O devices depend entirely on those present on your actual carrier board.

► Boot

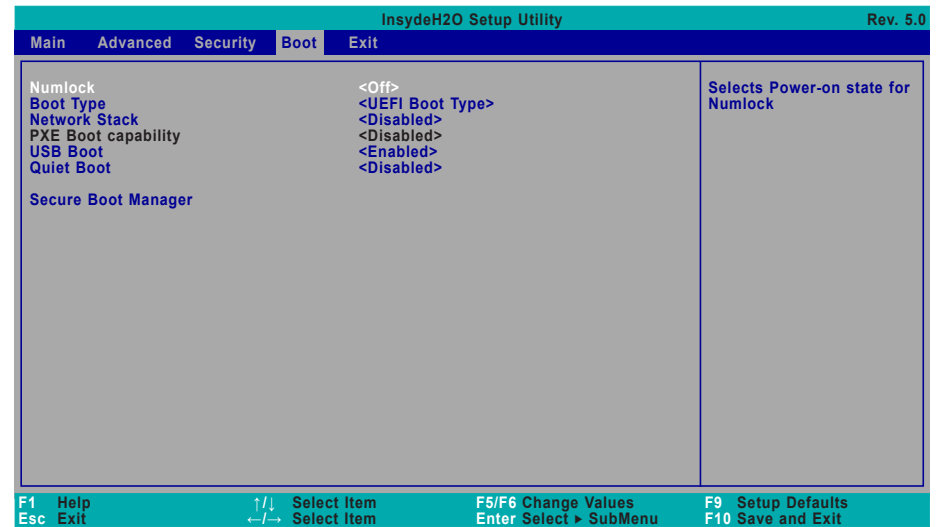

Numlock

Select the power-on state for numlock.

Boot Type

Select the boot type – UEFI Boot Type, Legacy Boot Type or Dual Boot Type. If you select "UEFI Boot Type" or "Dual Boot Type", the "Network Stack", "PXE Boot capability", "USB Boot" and "Quiet Boot" will show up. If you select "Legacy Boot Type", "PXE Boot to LAN", "USB Boot" and "Quiet Boot" will show up.



Note:
Please press F10 to save the settings and re-start the system board after changing "Boot Type".

Network Stack

This field is used to enable or disable network stacks, i.e. IPv4 or IPv6 network protocols.

► **Boot**

PXE Boot capability

This field is only available when "Boot Type" is set to "UEFI Boot Type" or "Dual Boot Type", and when "Network Stack" is enabled.

- **Disabled** Support Network Stack
- **UEFI** IPv4/IPv6
- **Legacy** Legacy PXE OPROM only

USB Boot

Enable or disable booting to USB boot devices.

Quiet Boot

Enable or disable booting in text mode.

Secure Boot Manager

Secure boot manager setting.

► Exit

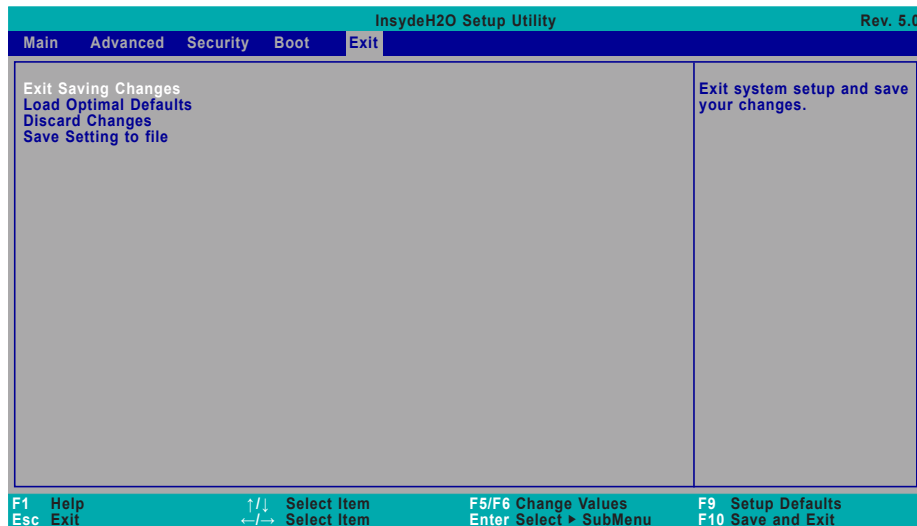

Exit Saving Changes

Select Yes and press <Enter> to exit the system setup and save your changes.

Load Optimal Defaults

Select YES and press <Enter> to load optimal defaults.

Discard Changes

Select YES and press <Enter> to exit the system setup without saving your changes.

Save Setting to file

Select this option to save BIOS configuration settings to a USB flash device.

► Updating the BIOS

To update the BIOS, you will need the new BIOS file and a flash utility. Please contact technical support or your sales representative for the files and specific instructions about how to update BIOS with the flash utility. For updating Insyde BIOS in UEFI mode, you may refer to the how-to video at <https://www.dfi.com/tw/knowledge/video/31>.

► Notice: BIOS SPI ROM

- 1. The Intel® Management Engine has already been integrated into this system board. Due to the safety concerns, the BIOS (SPI ROM) chip cannot be removed from this system board and used on another system board of the same model.
- 2. The BIOS (SPI ROM) on this system board must be the original equipment from the factory and cannot be used to replace one which has been utilized on other system boards.
- 3. If you do not follow the methods above, the Intel® Management Engine will not be updated and will cease to be effective.



Note:

- a. You can take advantage of flash tools to update the default configuration of the BIOS (SPI ROM) to the latest version anytime.
- b. When the BIOS IC needs to be replaced, you have to populate it properly onto the system board after the EEPROM programmer has been burned and follow the technical person's instructions to confirm that the MAC address should be burned or not.

Chapter 4 - RAID

The system board allows configuring RAID on Serial ATA drives. It supports RAID 0, RAID 1, and SPAN.

► RAID Levels Explanation

RAID 0 (Striped Disk Array without Fault Tolerance)

RAID 0 uses two new identical hard disk drives to read and write data in parallel, interleaved stacks. Data is divided into stripes and each stripe is written alternately between two disk drives. This improves the I/O performance of the drives at different channel; however it is not fault tolerant. A failed disk will result in data loss in the disk array.

RAID 1 (Mirroring Disk Array with Fault Tolerance)

RAID 1 copies and maintains an identical image of the data from one drive to the other drive. If a drive fails to function, the disk array management software directs all applications to the other drive since it contains a complete copy of the drive's data. This enhances data protection and increases fault tolerance to the entire system. Use two new drives or an existing drive and a new drive but the size of the new drive must be the same or larger than the existing drive.

RAID 5

RAID 5 stripes data and parity information across hard drives. It is fault tolerant and provides better hard drive performance and more storage capacity.

RAID 10 (Mirroring and Striping)

RAID 10 is a combination of data striping and data mirroring providing the benefits of both RAID 0 and RAID 1. Use four new drives or an existing drive and three new drives for this configuration.

RAID Level	Min. Drives	Protection	Description
RAID 0	2	None	Data striping without redundancy
RAID 1	2	Single Drive Failure	Disk mirroring
RAID 5	3	Single Drive Failure	Block-level data striping with distributed parity
RAID 10	4	1 Disk Per Mirrored Stripe (not same mirror)	Combination of RAID 0 (data striping) and RAID 1 (mirroring)
SPAN	2	None	Extends capacity to the sum of total drives, the second drive won't be used until the first one is full.

► Setup Procedure

To enable the RAID function, the following settings are required.

1. Connect the Serial ATA drives.
2. Enable RAID in the Insyde BIOS.
3. Create a RAID volume.
- 3-1. Create a RAID volume if the boot type is UEFI.
4. Install the Intel Rapid Storage Technology Utility.

Step 1: Install SATA Drives



Important:

1. Please make sure the SATA drives that you are to create a RAID volume with are connected and powered, and are able to be detected by the system. Otherwise, the RAID BIOS utility would not be accessible.
2. While creating a RAID volume, please make sure the system, drives, and cables are perfectly steady and mounted correctly. Disturbance during creating a RAID volume will result in irreversible data corruption sorted on the drive.

Step 2: Enter the RAID Menu in the Insyde BIOS

1. Power-on the system then press to enter the main menu of the Insyde BIOS.
2. Go to "Advanced" menu and select the "SATA Configuration" submenu.
3. Change the "SATA Mode Selection" to "RAID" mode.
4. Save the changes in the "Exit" menu.
5. Reboot the system.

► Setup Procedure

Step 3: Create a RAID Volume

1. When the Intel® RST option ROM status screen displays during POST, press <Ctrl> and <I> simultaneously to enter the option ROM user interface.
2. Select 1: Create RAID Volume and press <Enter>.
3. Create a volume name and press <Enter>.
4. Use the up or down arrow keys to select the RAID level and press <Enter>.
5. Use the up or down arrow keys to select the strip size and press <Enter>.
6. Select the capacity and press <Enter>. You must select less than one hundred percent of the available volume space to leave space for the second volume.
7. Press <Enter> to create the volume.
8. At the prompt, press <Y> to confirm volume creation.
9. Select 4: Exit and press <Enter>.
10. Press <Y> to confirm exit.

► Setup Procedure

Step 3-1: Create a RAID Volume if the boot type is UEFI

If the boot type is set to UEFI, RAID volume creation will be different. Please use the following steps to create RAID volumes. To set the boot type, enter the Insyde BIOS and go to “Boot” > “Boot Type”.

1. Go to the “Advanced” menu of the Insyde BIOS and select “UEFI Device Manager”.

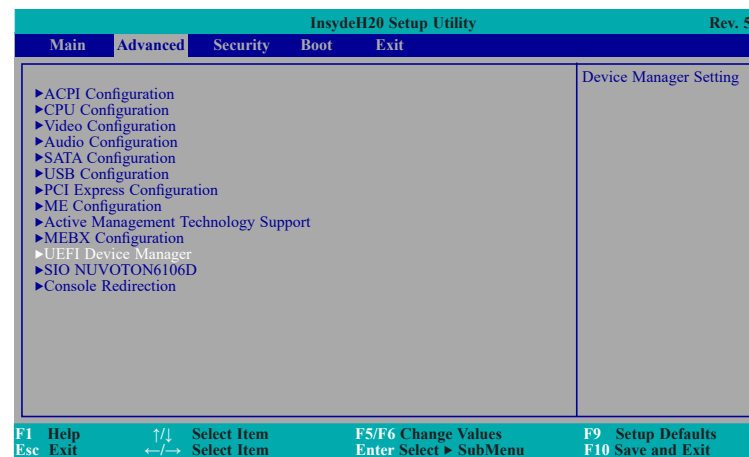

2. The screen displays all available drives. Select “Create RAID volume” to create a RAID volume”.
3. Use the up or down arrow keys to select the RAID level and press <Enter>.
4. Use the up or down arrow keys to scroll through the list of hard drives and press <Enter> to select the drive.
5. Press <Enter>.
6. Use the up or down arrow keys to select the strip size and press <Enter>.
7. Enter the volume size and press <Enter>.
8. At the prompt, press <Y> to confirm volume creation.

► Setup Procedure

Step 4: Install the Intel Rapid Storage Technology Utility

The Intel Rapid Storage Technology Utility can be installed from within Windows. It allows RAID volume management (create, delete, migrate) from within the operating system. It will also display useful SATA device and RAID volume information. The user interface, tray icon service and monitor service allow you to monitor the current status of the RAID volume and/or SATA drives. It enables enhanced performance and power management for the storage subsystem.

1. Download "IRST Driver" at our website.
2. Setup is ready to install the utility. Click "Next".

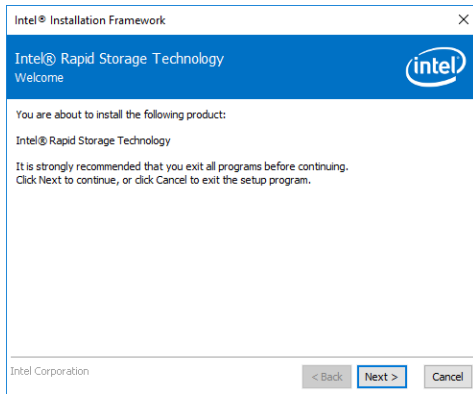

3. Read the license agreement and click "I accept the terms in the License Agreement". Then, click "Next".

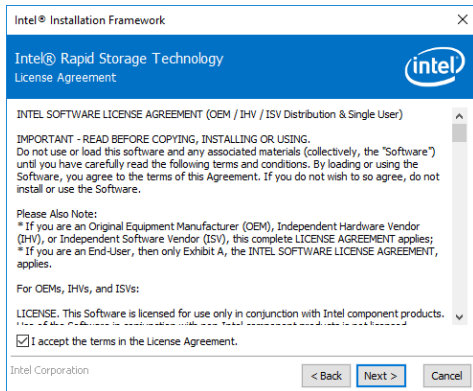

► Setup Procedure

4. Go through the readme document to view system requirements and installation information then click "Next".

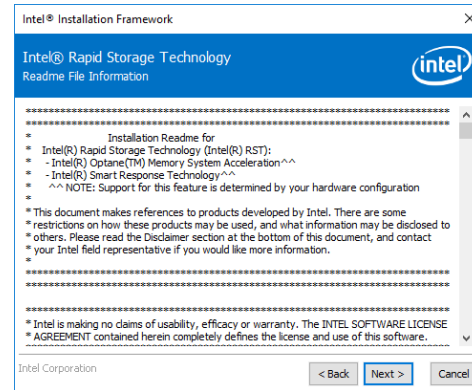

5. Click "Next" to install to the default folder or click "change" to choose another destination folder".

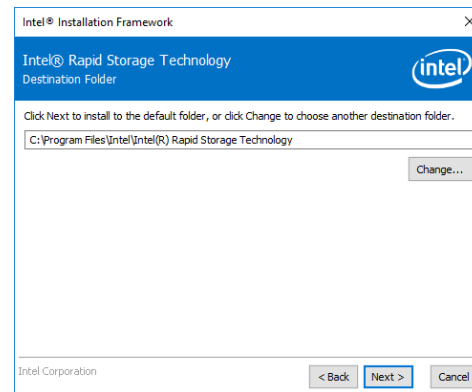

6. Confirm the installation and click "Next".

► Setup Procedure

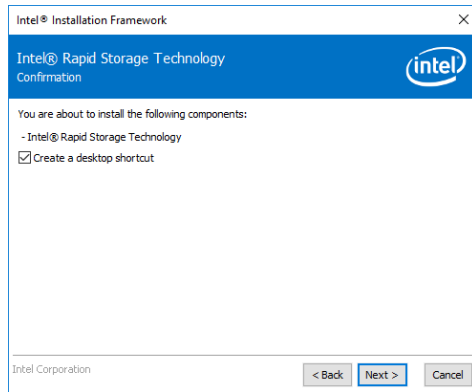

7. Click "Yes, I want to restart this computer now" to complete the installation and then click "Finish".

