



KS101-BT
10.1" Touch Panel PC
User's Manual

Copyright

This publication contains information that is protected by copyright. No part of it may be reproduced in any form or by any means or used to make any transformation/adaptation without the prior written permission from the copyright holders.

This publication is provided for informational purposes only. The manufacturer makes no representations or warranties with respect to the contents or use of this manual and specifically disclaims any express or implied warranties of merchantability or fitness for any particular purpose. The user will assume the entire risk of the use or the results of the use of this document. Further, the manufacturer reserves the right to revise this publication and make changes to its contents at any time, without obligation to notify any person or entity of such revisions or changes.

Changes after the publication's first release will be based on the product's revision. The website will always provide the most updated information.

© 2017. All Rights Reserved.

Trademarks

Product names or trademarks appearing in this manual are for identification purpose only and are the properties of the respective owners.

FCC and DOC Statement on Class A

This equipment has been tested and found to comply with the limits for a Class A digital device, pursuant to Part 15 of the FCC rules. These limits are designed to provide reasonable protection against harmful interference when the equipment is operated in a residential installation. This equipment generates, uses and can radiate radio frequency energy and, if not installed and used in accordance with the instruction manual, may cause harmful interference to radio communications. However, there is no guarantee that interference will not occur in a particular installation. If this equipment does cause harmful interference to radio or television reception, which can be determined by turning the equipment off and on, the user is encouraged to try to correct the interference by one or more of the following measures:

- Reorient or relocate the receiving antenna.
- Increase the separation between the equipment and the receiver.
- Connect the equipment into an outlet on a circuit different from that to which the receiver is connected.
- Consult the dealer or an experienced radio TV technician for help.

Notice:

1. The changes or modifications not expressly approved by the party responsible for compliance could void the user's authority to operate the equipment.
2. Shielded interface cables must be used in order to comply with the emission limits.

Table of Contents

Copyright	2	Backlight Enable Power Select	16
Trademarks	2	Dimming Mode Select.....	16
FCC and DOC Statement on Class A.....	2	Digital I/O Power Select.....	17
About this Manual	4	Digital I/O Output State.....	17
Warranty	4	LCD/Inverter Power Select	18
Static Electricity Precautions.....	4	COM 4/DIO Select.....	18
Safety Measures.....	4	Chapter 5 - Ports and Connectors	19
Safety Precautions	5	Top Panel I/O Ports	19
About the Package	5	Bottom Panel I/O Ports.....	19
Chapter 1 - Introduction	6	USB Ports.....	20
Overview.....	6	COM (Serial) Ports	21
Key Features	6	Graphics Interfaces	22
Specifications	7	DC-in Power Connector	23
Getting to Know the KS101-BT	8	RJ45 LAN Ports	23
Mechanical Dimensions.....	9	Audio Output	24
Chapter 2 - Getting Started.....	10	I/O Connectors	24
Chapter 3 - Installing Devices	11	Serial ATA Connector	24
Removing the Chassis Cover.....	11	Serial ATA Power Connector.....	24
Installing a SATA Drive.....	12	LVDS LCD Panel	25
Chapter 4 - Jumper Settings.....	14	Cooling Fan Connector.....	26
Clear CMOS Data	14	Chassis Intrusion Connector	26
Auto Power-on Select.....	14	Expansion Slots	27
USB Power Select.....	15	Battery	27
Panel Power Select.....	15	Chapter 6 - Mounting Options	28
		Wall Mount	28
		Panel Mount	29
		Chapter 7 - BIOS Setup	31
		Chapter 8 - Supported Software.....	47
		Appendix A - Watchdog Sample Code	59
		Appendix B - System Error Message.....	60
		Appendix C - Troubleshooting Checklist	62

About this Manual

An electronic file of this manual is included in the CD. To view the user's manual in the CD, insert the CD into a CD-ROM drive. The autorun screen (Main Board Utility CD) will appear. Click "User's Manual" on the main menu.

Warranty

1. Warranty does not cover damages or failures that arised from misuse of the product, inability to use the product, unauthorized replacement or alteration of components and product specifications.
2. The warranty is void if the product has been subjected to physical abuse, improper installation, modification, accidents or unauthorized repair of the product.
3. Unless otherwise instructed in this user's manual, the user may not, under any circumstances, attempt to perform service, adjustments or repairs on the product, whether in or out of warranty. It must be returned to the purchase point, factory or authorized service agency for all such work.
4. We will not be liable for any indirect, special, incidental or consequential damages to the product that has been modified or altered.

Static Electricity Precautions

It is quite easy to inadvertently damage your PC, system board, components or devices even before installing them in your system unit. Static electrical discharge can damage computer components without causing any signs of physical damage. You must take extra care in handling them to ensure against electrostatic build-up.

1. To prevent electrostatic build-up, leave the system board in its anti-static bag until you are ready to install it.
2. Wear an antistatic wrist strap.
3. Do all preparation work on a static-free surface.
4. Hold the device only by its edges. Be careful not to touch any of the components, contacts or connections.
5. Avoid touching the pins or contacts on all modules and connectors. Hold modules or connectors by their ends.



Important:

Electrostatic discharge (ESD) can damage your processor, disk drive and other components. Perform the upgrade instruction procedures described at an ESD workstation only. If such a station is not available, you can provide some ESD protection by wearing an antistatic wrist strap and attaching it to a metal part of the system chassis. If a wrist strap is unavailable, establish and maintain contact with the system chassis throughout any procedures requiring ESD protection.

Safety Measures

To avoid damages to the system:

- Use the correct AC input voltage range.

To reduce the risk of electric shock:

- Unplug the power cord before removing the system chassis cover for installation or servicing. After installation or servicing, cover the system chassis before plugging the power cord.

Battery:

- Danger of explosion if battery incorrectly replaced.
- Replace only with the same or equivalent type recommend by the manufacturer.
- Dispose of used batteries according to local ordinance.

Safety Precautions

- Use the correct DC input voltage range.
- Unplug the power cord before removing the system chassis cover for installation or servicing. After installation or servicing, cover the system chassis before plugging the power cord.
- Danger of explosion if battery incorrectly replaced.
- Replace only with the same or equivalent type recommend by the manufacturer.
- Dispose of used batteries according to local ordinance.
- Keep this system away from humidity.
- Place the system on a stable surface. Dropping it or letting it fall may cause damage.
- The openings on the system are for air ventilation to protect the system from overheating. **DO NOT COVER THE OPENINGS.**
- Place the power cord in such a way that it will not be stepped on. Do not place anything on top of the power cord. Use a power cord that has been approved for use with the system and that it matches the voltage and current marked on the system's electrical range label.
- If the system will not be used for a long time, disconnect it from the power source to avoid damage by transient overvoltage.
- If one of the following occurs, consult a service personnel:
 - The power cord or plug is damaged.
 - Liquid has penetrated the system.
 - The system has been exposed to moisture.
 - The system is not working properly.
 - The system dropped or is damaged.
 - The system has obvious signs of breakage.
- The unit uses a three-wire ground cable which is equipped with a third pin to ground the unit and prevent electric shock. Do not defeat the purpose of this pin. If your outlet does not support this kind of plug, contact your electrician to replace the outlet.
- Disconnect the system from the DC outlet before cleaning. Use a damp cloth. Do not use liquid or spray detergents for cleaning.

About the Package

The package contains the following items. If any of these items are missing or damaged, please contact your dealer or sales representative for assistance.

- 1 10.1" Touch Panel PC
- 1 sheet of Poron Foam
- 1 HDD drive bay kit
- 1 CD disk includes: Manual

Optional Items

- Wall Mount kit
- Panel Mount kit
- Power Cord

The board and accessories in the package may not come similar to the information listed above. This may differ in accordance to the sales region or models in which it was sold. For more information about the standard package in your region, please contact your dealer or sales representative.

Chapter 1 - Introduction

Overview

KS101-BT



Side View

Top View



Bottom View



Key Features

Model Name	KS101-BT
Processor	Intel® Atom™ E3800 Series / Intel® Celeron® Processor J1900
LAN	2 LAN ports
COM	5 COM ports (one of them can be an 8-bit DIO)
Display	1 HDMI port
USB	3 USB 2.0 ports 1 USB 3.0 port
Audio	Line-out and Microphone port

Specifications

Processor	Intel® Atom™ Processor E3800 Series, BGA 1170 Intel® Atom™ Processor E3845, Quad Core, 2M Cache, 1.91GHz, 10W Intel® Atom™ Processor J1900, Quad Core, 2M Cache, 2GHz (2.42GHz), 10W
Memory	4GB/2GB Memory Down Single Channel DDR3L 1333MHz
BIOS	AMI SPI 64Mbit
Display and Touch Screen	<ul style="list-style-type: none"> Display: 10.1" 1280x800 TFT LCD Panel with Capacitive Touch Screen Brightness: 500 cd/m² Contrast: 800:1 Backlight Lifetime: 50,000 hours
Graphics	Intel® HD Graphics Display port: HDMI (resolution up to 1920x1080 @ 60Hz) Supported applications: DirectX 11, OCL 1.2, OGL 4.0 Codecs: H.264, MPEG2, MVC, VC-1, WMV9, VP8 (supported version dependent on OS)
Storage	1 x 2.5" SATA 2.0 Drive Bay 1 x micro SD (available upon request)
Expansion	1 x Full-size Mini PCIe (PCIe/USB/4G) 1 x Full-size Mini PCIe (mSATA) 1 x Half-size Mini PCIe (PCIe/USB/LPC)
Audio Controller	Realtek ALC888 5.1-channel
Ethernet Controller	2 x Intel® I210AT PCIe (10/100/1000Mbps)
LED Indicators	1 x Power LED 1 x Status LED
Top I/O Ports	3 x RS-232/422/485 (DB-9, one of them supports 8-bit DIO) 1 x USB 3.0 (type A) 1 x HDMI 1 x Power Button 1 x Reset Button 2 x Wi-Fi Module Antenna Hole
Bottom I/O Ports	2 x GbE (RJ-45) (10/100/1000Mbps) 1 x RS-232/422/485 (DB-9) 1 x RS-232 (DB-9) 3 x USB 2.0 (type A) 1 x Line-out 1 x Mic-in 1 x DC-in connector
Watchdog Timer	System Reset, Programmable via Software from 1 to 255 Seconds
Power	Type:12~36V DC Connector: DC Jack

OS Support	Windows 7 Embedded P SKU (32bit/64bit) Windows 8.1 Embedded (32bit/64bit) Windows 10 IoT Enterprise (32bit/64bit) Ubuntu-15.10 / Yocto
Mechanism	Construction: Sheet Metal IP Rating: IP65 Front Panel Protection Mounting: Panel/VESA Mount* Dimensions (W x H x D): 294mm x 48mm x 193mm
Environment	Operating Temperature: 0 to 60°C Storage Temperature: -30 to 80°C Relative Humidity: 5 to 85% RH (non-condensing)
Tests and Certification	Shock: OP: 3G Non-OP: 5G Vibration: OP Random 5~500Hz 1G Non-OP Sine wave 10~500Hz 2G

Note:

*Optional items are not supported in standard model. Please contact your sales representative for more information.

Getting to Know the KS101-BT

Top View

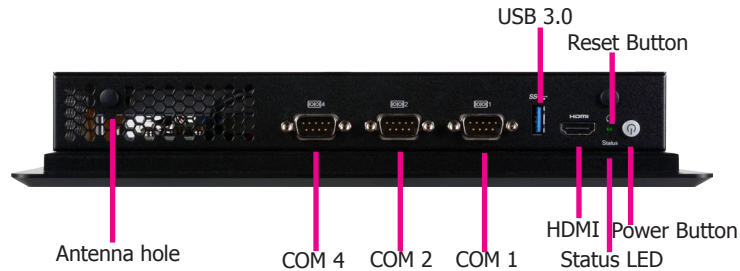

COM Ports

Used to connect serial devices. COM 4 can be used as an 8-bit DIO or a serial port via jumper selection.

USB 3.0 Port

Used to connect USB 3.0/2.0/1.1 devices.

HDMI Port

Used to connect to the HDMI port of a display.

Status LED (Blue)

Indicates system status.

Status LED				
Suspend Mode	S0	S1	S3	S4, S5
LED Behavior	Off	Quick Blink (cycle 1 sec)	Slow Blink (cycle >1 sec)	Off

Reset Button

Press to restart the system without going through a full shutdown and boot cycle.

Power Button with LED (Green)

Press to power on or power off the system.

Wireless Antenna Holes

Reserved for installing wireless antennas.

Bottom View

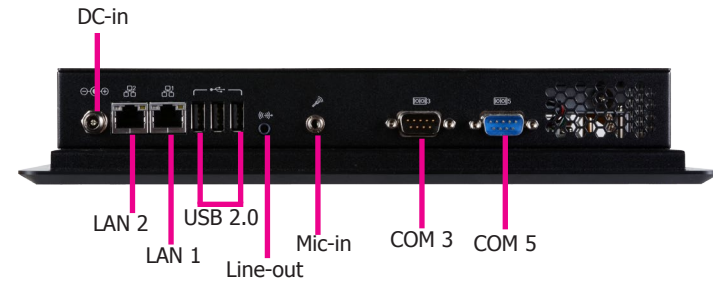

DC-in

Plugs a power adapter.

LAN Ports

Connect a network device or a LAN cable for network connectivity.

USB 2.0 Port

Connects USB 2.0/1.1 devices.

Line-out

Connects a speaker.

Mic-in

Connects a microphone.

COM Ports

Connect serial devices. COM 3 can be used as an RS232, RS422 or RS485 port whereas COM 5 can only be used for RS232 communication.

Mechanical Dimensions

KS101-BT

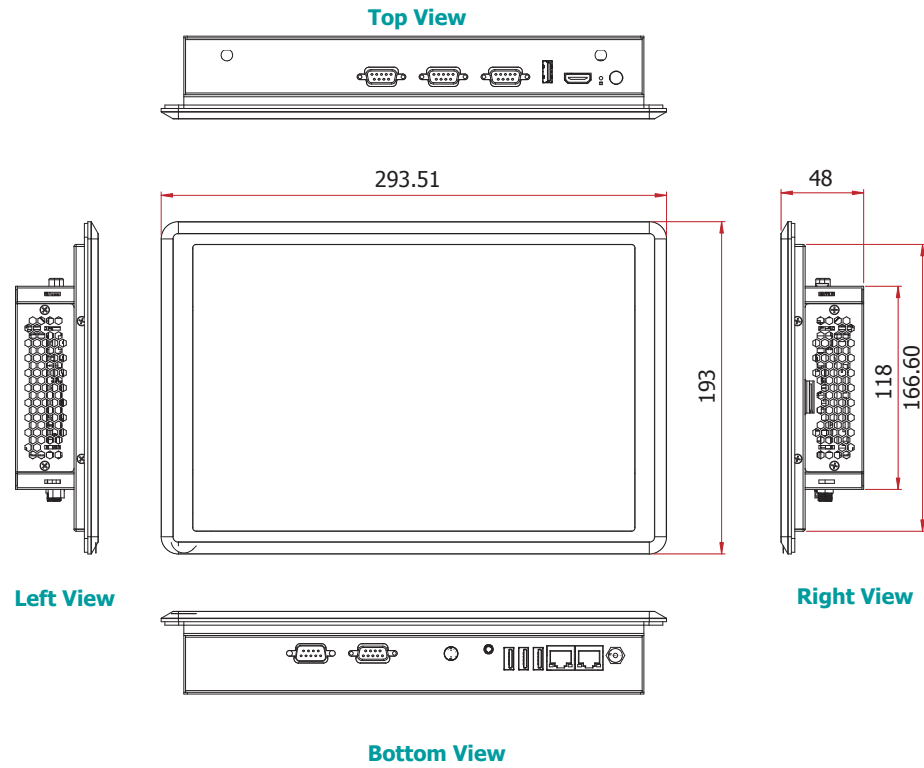

Motherboard Dimensions

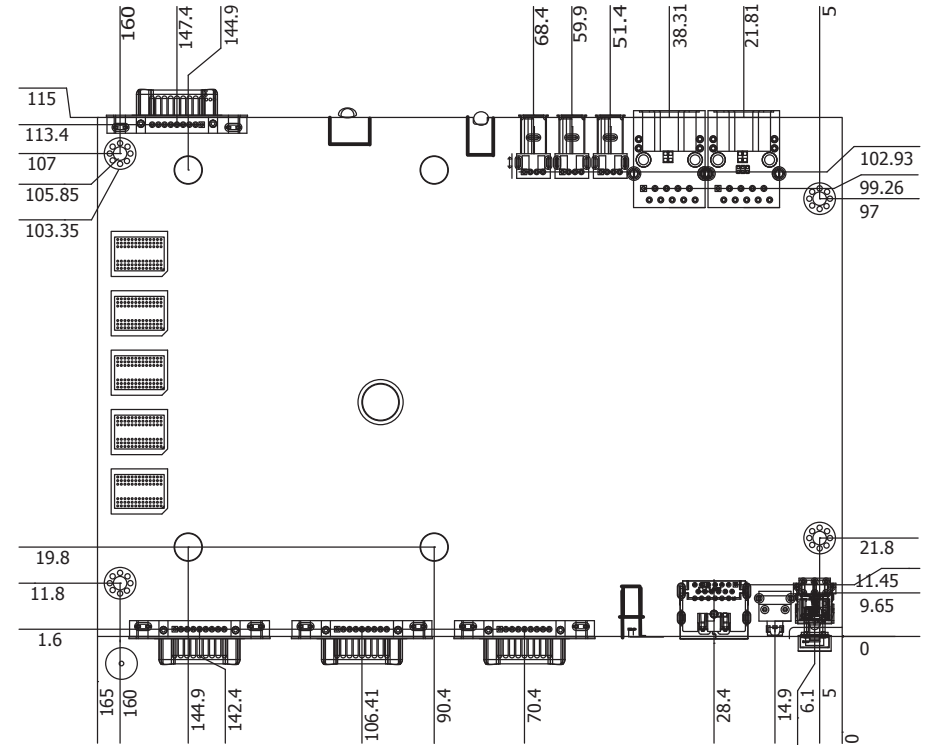

Chapter 2 - Getting Started

Preparing the System

Before you start using the system, you need the following items:

- SATA hard drive
- AC power adapter
- CD-ROM drive (for installing software/drivers)

Installing Devices

The following are devices that can be installed in the system.

- SATA hard drive
- Mini PCIe/mSATA card

Configuring the BIOS

To get you started, you may need to change configurations such as the date, time and the type of hard disk drive.

1. Power on the system.
2. After the memory test, the message "Press DEL to run setup" will appear on the screen. Press the Delete key to enter the BIOS setup utility.

Installing the Operating System

Depending on the method you choose to install your system, you may need to install a CD-ROM drive in order to run the Operating System CD.

Make sure that a 2.5" SATA drive is already installed.

1. Refer to the following chapters for information on installing a SATA drive.
2. Refer to your operating system manual for instructions on installing the operating system.

Installing the Drivers

The system package includes a CD disk. The CD includes drivers that must be installed to provide the best system performance. Refer to the Supported Software chapter for instructions on installing the drivers.

Chapter 3 - Installing Devices

Removing the Chassis Cover

1. Make sure the system and all other peripheral devices connected to it have been powered-off.
2. Disconnect all power cords and cables.
3. The 8 mounting screws on the rear side of the system are used to secure the cover to the chassis. Remove these screws and put them in a safe place for later use.



4. Lift the cover up to open the system.



5. The Mini PCIe and the microSD slots are readily accessible after removing the chassis cover.

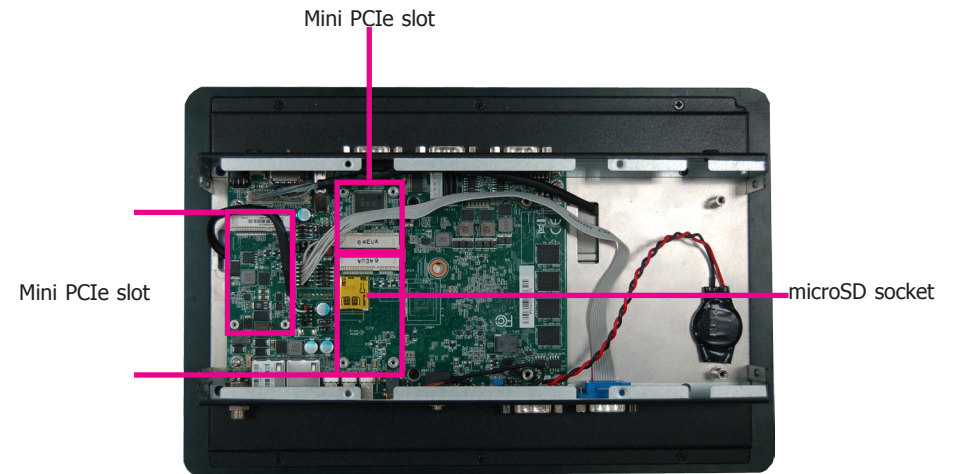

Installing a SATA Drive

1. The SATA data and power connectors are on the system board.

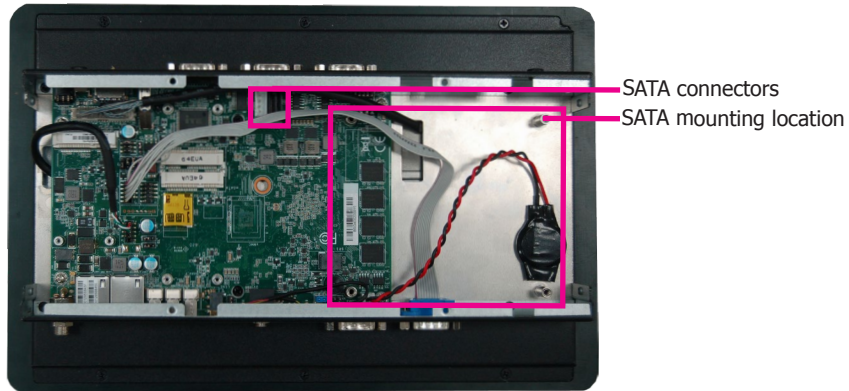

2. Align the mounting holes of the SATA HDD with the mounting holes on the HDD drive bay and use the mounting screws included in the HDD drive bay kit to attach the SATA HDD to the drive bay.

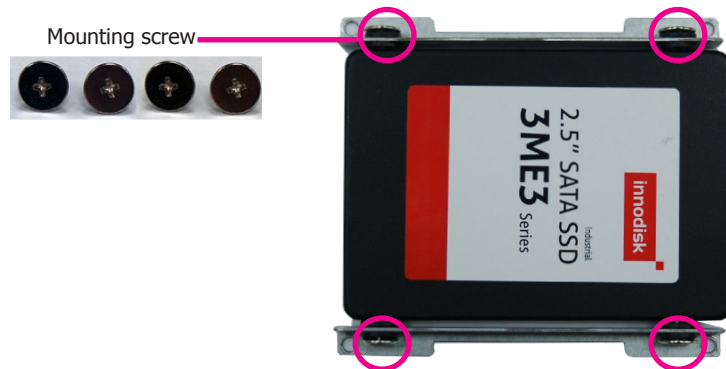

3. Connect one end of the SATA cable to the SATA power and data connectors on the SATA drive and the other end of the SATA cable to the SATA power and data connectors on the system board.

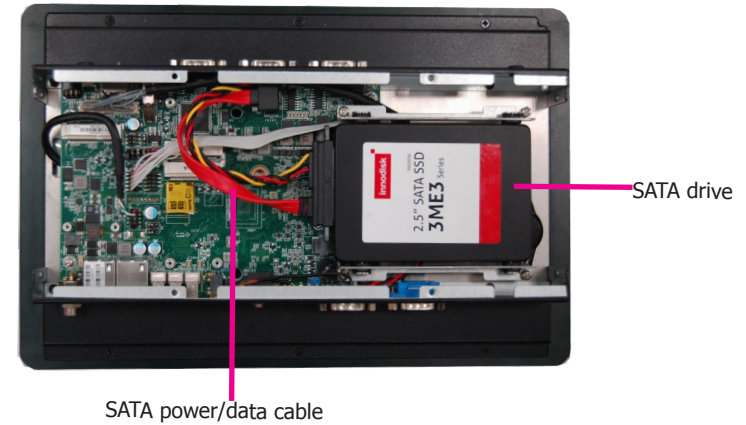

4. Align the mounting holes of the HDD drive bay with the mounting holes on the system and use the provided mounting screws to secure the drive bay in place.

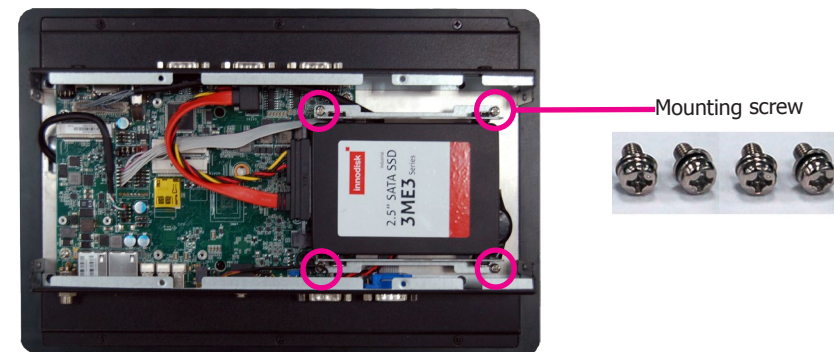

Installing a Mini PCIe Card

The system board is equipped with 3 Mini PCIe slots: two full-size and one half-size slots. Here we will demonstrate the installation of a full-size Mini PCIe card (working in conjunction with a SIM card) for 3G/4G connectivity.

1. Grasp the Mini PCIe card by its edges and align the notch in the connector of the PCIe card with the notch in the connector on the system board.

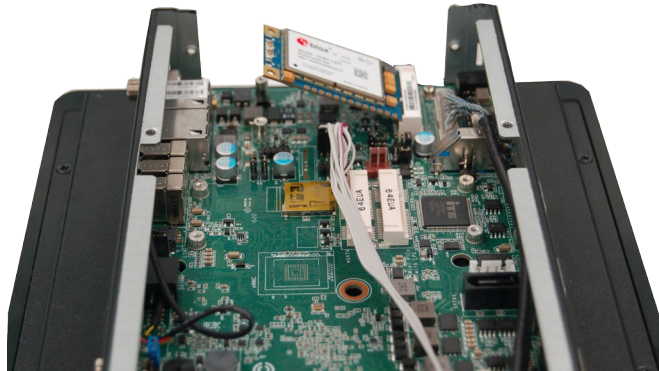

2. Push the Mini PCIe card down and use the provided mounting screws to secure the card on the system board.

**Note:**

The system also has one additional full-size Mini PCIe and one half-size Mini PCIe slot that use the mSATA and LPC interface respectively.

Chapter 4 - Jumper Settings

Clear CMOS Data

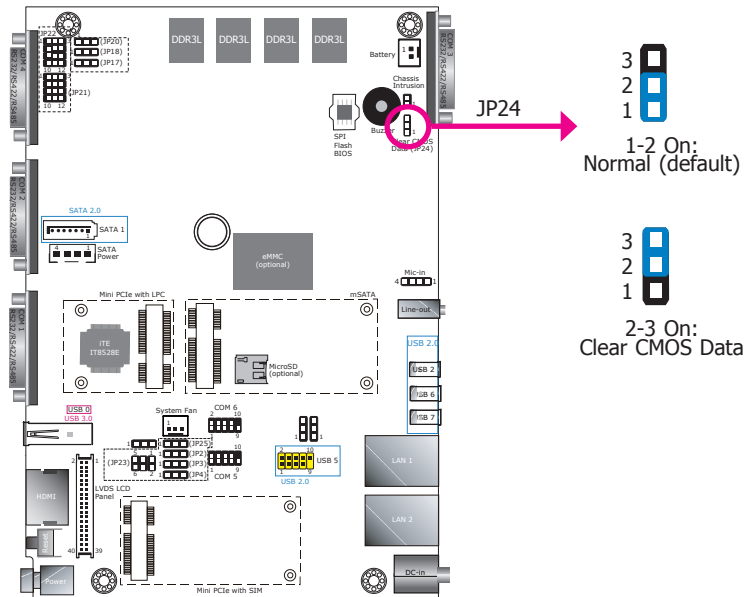

You can reconfigure the system with the default values stored in the ROM BIOS if you encounter the following situations:

- CMOS data becomes corrupted.
- You forgot the supervisor or user password.

To load the default values stored in the ROM BIOS, please follow these steps below:

- Power-off the system and unplug the power cord.
- Set jumper pins 2 and 3 to On. Wait for a few seconds and set the jumper back to its default setting, pins 1 and 2 On.
- Now plug the power cord and power on the system.

Auto Power-on Select

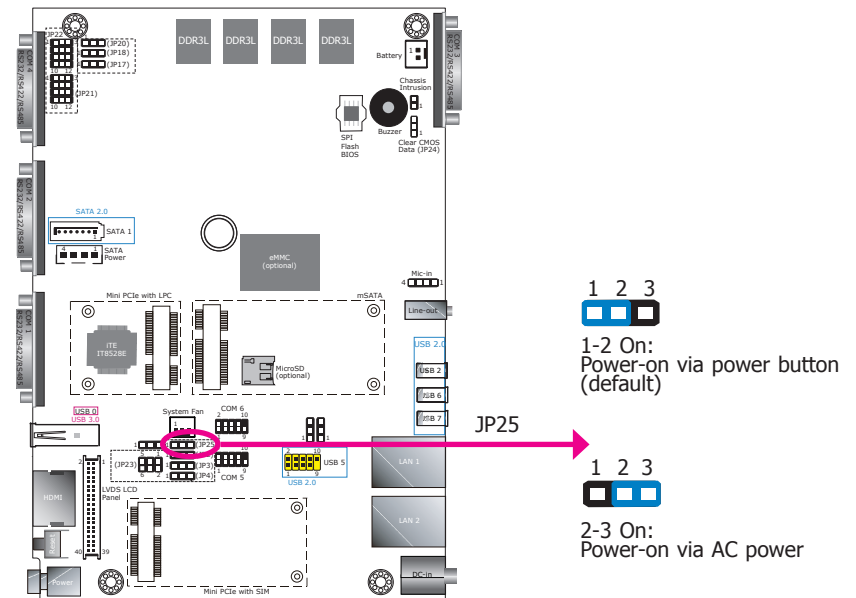

JP25 is used to select the method of powering on the system. If you want the system to power-on whenever AC power comes in, set JP25 pins 2 and 3 to On. If you want to use the power button, set pins 1 and 2 to On.

When using the JP25 "Power On" feature to power the system back on after a power failure occurs, the system may not power on if the power lost is resumed within 5 seconds (i.e., power flicker).

USB Power Select

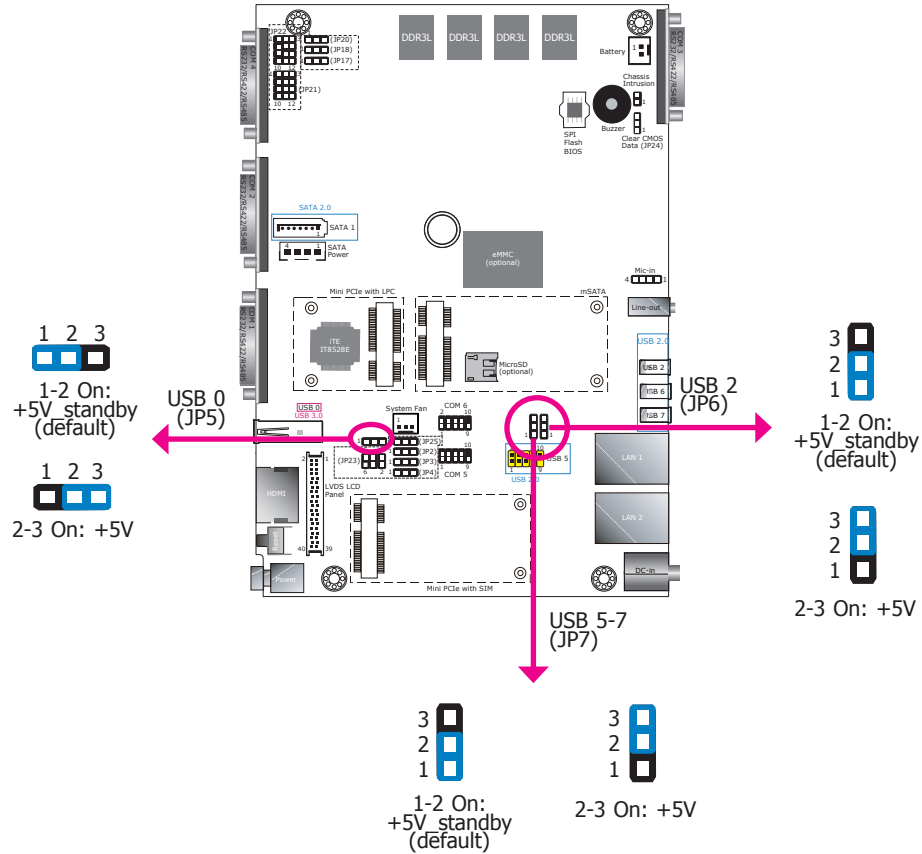

JP5, JP6 and JP7 are used to select the power for the USB ports of USB 0, USB 2 and USB 5-7 respectively. Selecting +5V_standby will allow you to use USB devices to wake up the system.

Important: If you are using the Wake-On-USB Keyboard/Mouse function for 2 USB ports, the +5V_standby power source of your power supply must support $\geq 1.5A$. For 3 or more USB ports, the +5V_standby power source of your power supply must support $\geq 2A$.

Panel Power Select

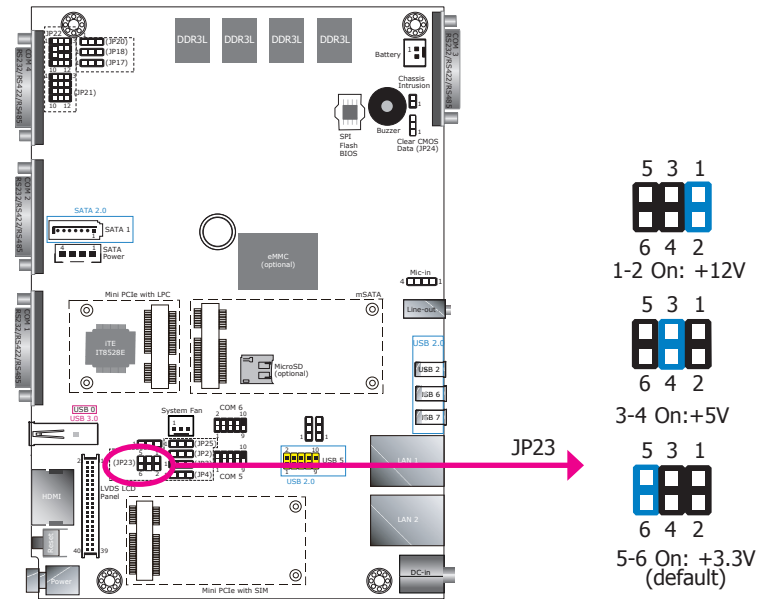

JP23 is used to select the power supplied with the LCD panel.

Important: Before powering on the system, make sure that the power settings of JP23 match the LCD panel's specification. Selecting the incorrect voltage will seriously damage the LCD panel.

Backlight Enable Power Select

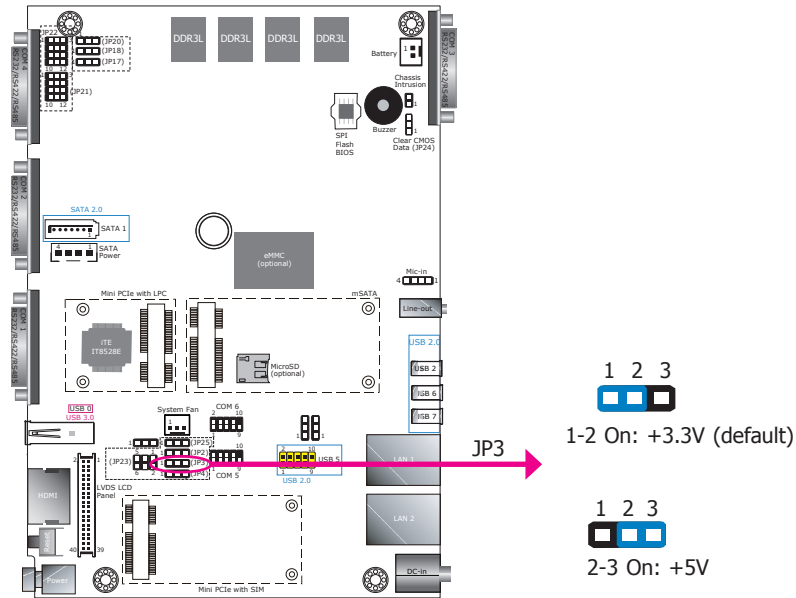

JP3 is used to select the power level of backlight brightness control: +5V or +3.3V.

Important: Before powering-on the system, make sure that the power settings of JP3 match the power specification of backlight control. Selecting the incorrect voltage will seriously damage the backlight.

Dimming Mode Select

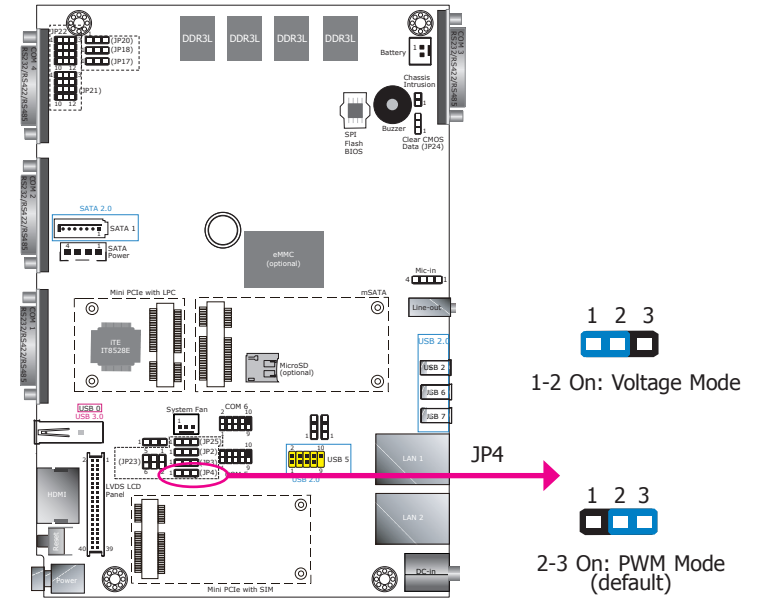

JP4 allows you to select the mode for the backlight brightness control of the LVDS panel.

Important: You need to refer to your panel's user guide to determine the type of mode (PWM or Voltage) that is appropriate for your panel.

Digital I/O Power Select

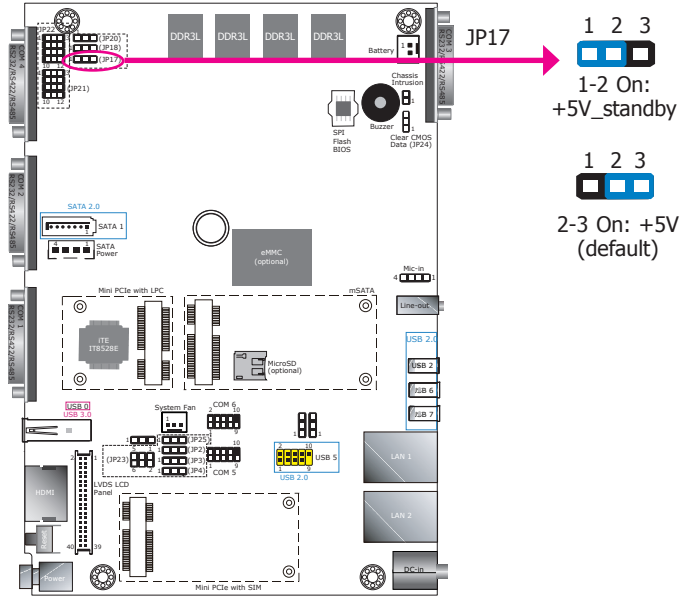

JP17 is used to select the power of the DIO (Digital Input/Output) signal.

Digital I/O Output State

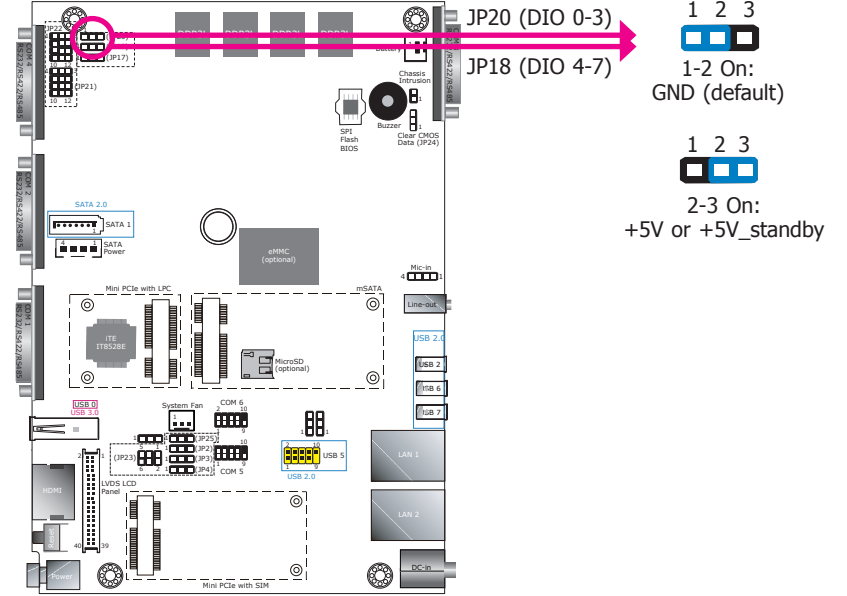

Based on the power level of DIO (Digital I/O) selected on JP17, JP20 (DIO pin 0-3) and JP18 (DIO pin 4-7) are used to select the state of DIO output: pull-high or pull-low. When selecting pull-high, the power selection will be set as per JP17's setting.

LCD/Inverter Power Select

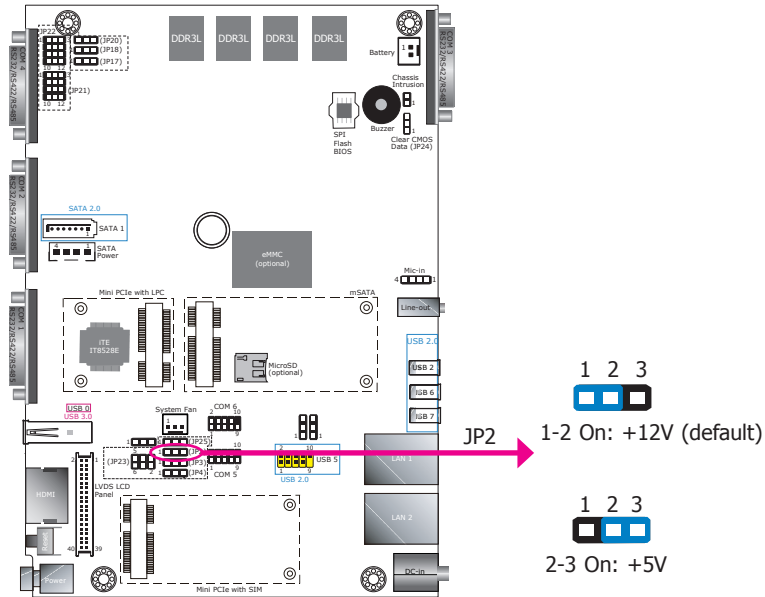

JP2 is used to select the power level of the LCD/inverter power connector.

COM 4/DIO Select

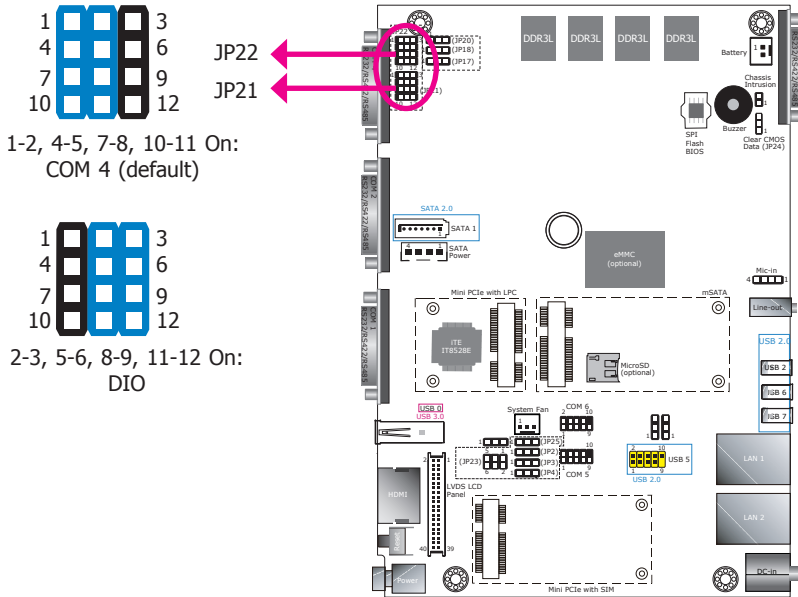

The system board uses JP1 and JP2 to select between RS232/422/485 COM 4 or an 8-bit DIO connector.



Note: You cannot use COM 4 and DIO at the same time. Please set up JP1 and JP2 together.

Chapter 5 - Ports and Connectors

Top Panel I/O Ports

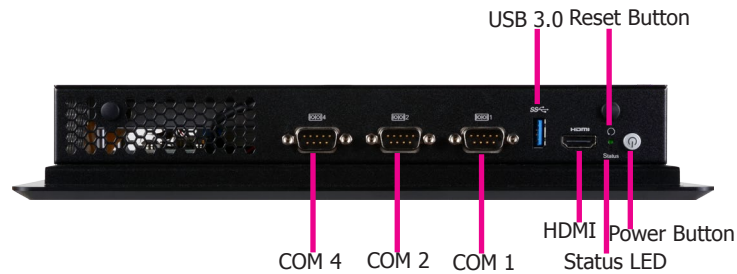

The top panel I/O consists of the following ports and connectors:

- 1 power button
- 1 reset button
- 1 USB 3.0 port
- 1 HDMI port
- 3 DB-9 serial ports
 - Support RS232/RS422/RS485
 - COM 4 supports an optional 8-bit DIO

Bottom Panel I/O Ports

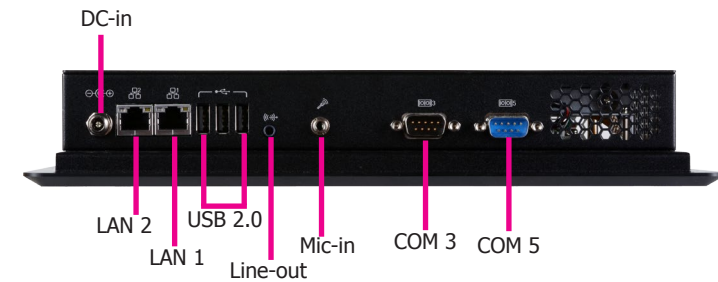

The bottom panel I/O consists of the following ports and connectors:

- 1 DC-in power connector
- 2 RJ45 LAN ports
- 3 USB 2.0 ports
- 1 Line-out and microphone jack
- 2 DB-9 serial ports
 - COM 3 supports RS232/RS422/RS485
 - COM 5 supports only RS232

USB Ports

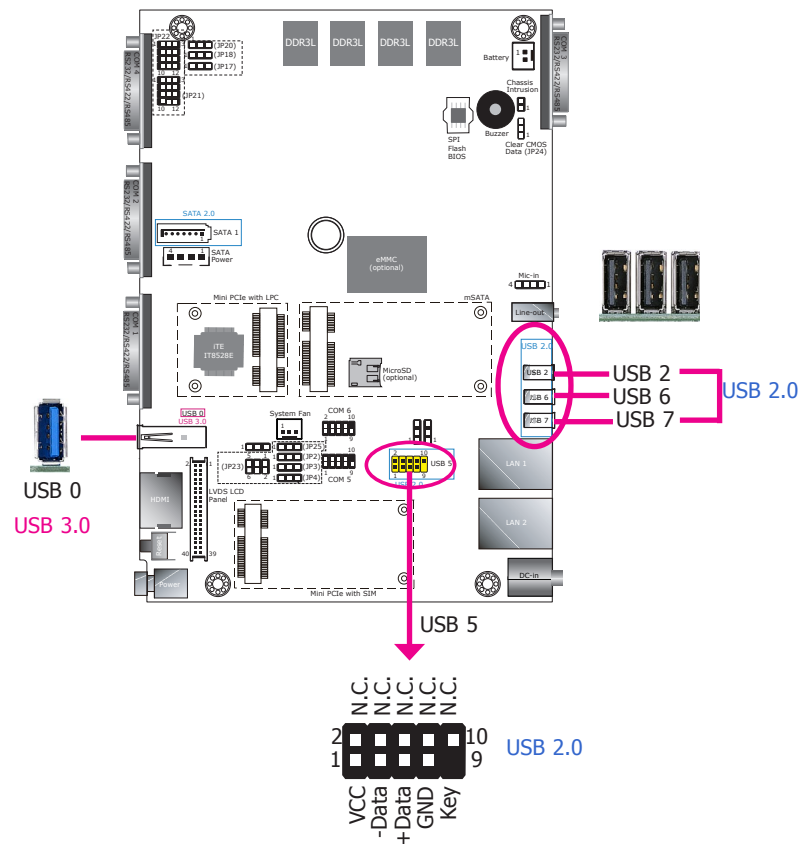

The USB device allows data exchange between your computer and a wide range of simultaneously accessible external Plug and Play peripherals.

The system board is equipped with one onboard USB 3.0 port (USB 0) and three onboard USB 2.0 ports (USB 2/6/7). In addition, it also has a 10-pin connector and allows you to connect one additional USB 2.0 port (USB 5).

BIOS Setting

Configure the onboard USB in the Advanced menu ("USB Configuration" submenu) of the BIOS. Refer to Chapter 7 for more information.

Driver Installation

You may need to install the proper drivers in your operating system to use the USB device. Refer to Chapter 8 for more information.

Wake-On-USB Keyboard/Mouse

The Wake-On-USB Keyboard/Mouse function allows you to use a USB keyboard or USB mouse to wake up a system from the S3 (STR - Suspend To RAM) state. To use this function, you must select voltage state for the USB ports via jumper settings.

Jumper Settings for the Wake-On-USB function

JP5, JP6 and JP7 must be set to "1-2 On: +5V_standby". Refer to "USB Power Select" in the previous chapter for more information.



Important:

If you are using the Wake-On-USB Keyboard/Mouse function for 2 USB ports, the +5V_standby power source of your power supply must support $\geq 1.5A$. For 3 or more USB ports, the +5V_standby power source of your power supply must support $\geq 2A$.



Important: When installing Windows 7, only native USB 2.0 ports (USB port 0 and USB port 2) can operate under DOS mode. Please refer to the following tables for more information on the type of USB ports and its support under different operating systems.

Table 1. OS Selection

Operation Environment for Customers	DOS	Windows 7	Windows 8.x	Linux
OS Selection in the BIOS Advanced Menu	Windows 8.x	Windows 7	Windows 8.x	Windows 8.x
Available USB ports	All	When installing Windows 7 for the first time, only native USB 2.0 ports can work. Please refer to table 2 below for the USB type.	All	All

Table 2. The Type of USB Ports

Model Name	BT253
USB 3.0	Native
USB 0	Native
USB 2	Native (share with USB 3.0 port)
USB 5	HSIC port 1
USB 6	HSIC port 2
USB 7	HSIC port 3

COM (Serial) Ports

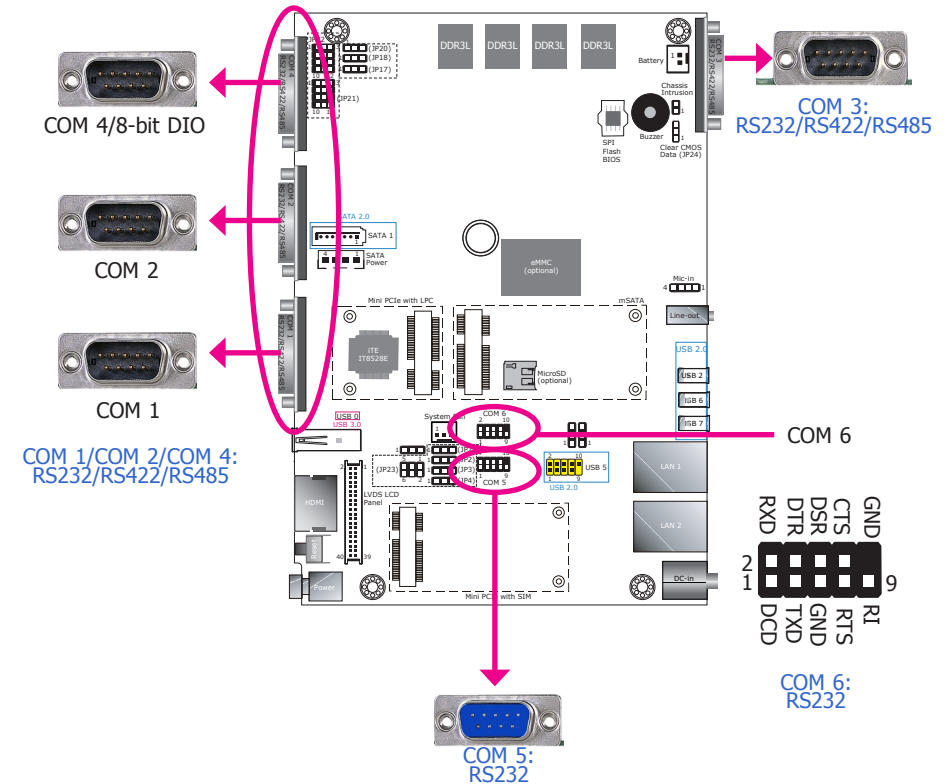

The serial ports are asynchronous communication ports with 16C550A-compatible UARTs that can be used with modems, serial printers, remote display terminals, and other serial devices.

Please use the BIOS setup utility to configure serial port communication mode for COM 1 to COM 4.

BIOS Setting

Configure the serial ports in the Super IO configuration ("NCT6106D Super I/O Configuration" submenu) of the BIOS. Refer to Chapter 7 for more information.

COM 1 / COM 2 / COM 3 / COM 4 / COM 5 (only RS232)

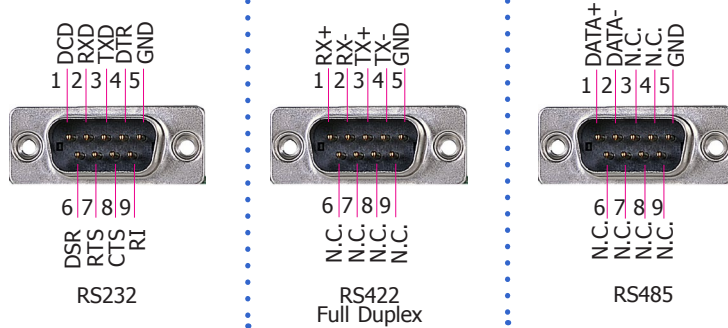

COM 4 (Serial) Port

This DB-9 port can be used as an RS232/422/485 COM port or as an isolated 8-bit Digital Input/Output via jumper settings. Refer to "COM 4/DIO Select" in the previous chapter for its configuration.

8-bit DIO

Alternatively, this DB-9 port can be used as digital inputs or outputs. The 8-bit Digital I/O connector provides monitoring and control function to external devices connected to the connector. You can use the HW utility provided in the Manual and Driver CD to set the DIO pins to be either input or output.

Pins	COM 4 Function			DIO Function
	RS232	RS422	RS485	
1	DCD	RX+	DATA+	DIO_0
2	RXD	RX-	DATA-	DIO_1
3	TXD	TX+	NC	DIO_2
4	DTR	TX-	NC	DIO_3
5	GND	GND	GND	GND
6	DSR	NC	NC	DIO_4
7	RTS	NC	NC	DIO_5
8	CTS	NC	NC	DIO_6
9	RI	NC	NC	DIO_7

Graphics Interfaces

The system is equipped with an external HDMI port.

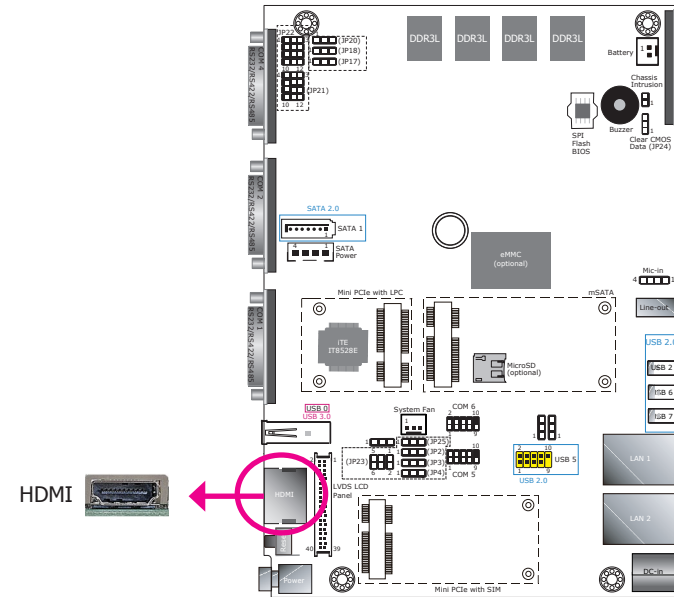

The HDMI port, which carries both digital audio and video signals, is used to connect a LCD monitor or digital TV that has an HDMI port.

BIOS Setting

Configure the display devices in the Chipset menu ("North Bridge" submenu) of the BIOS. Refer to Chapter 7 for more information.

DC-in Power Connector

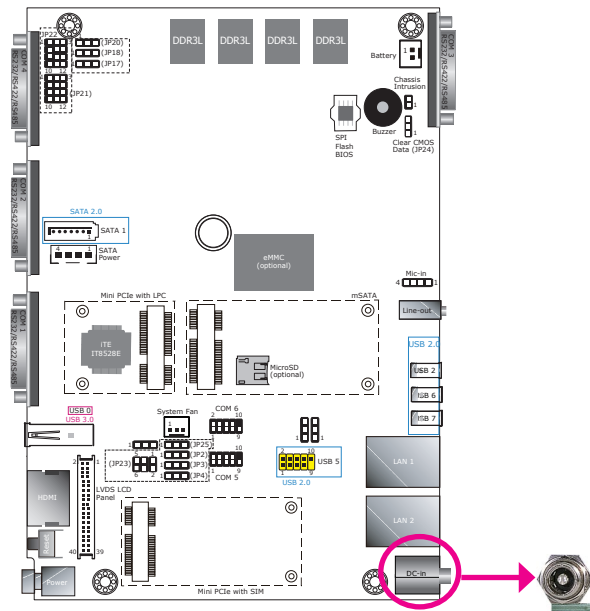

Connect a DC power cord to this jack. Use a power adapter within 12~36V DC output voltage. Using a power adapter that does not conform to the specified voltage may fail to boot the system or cause damage to the system board.

RJ45 LAN Ports

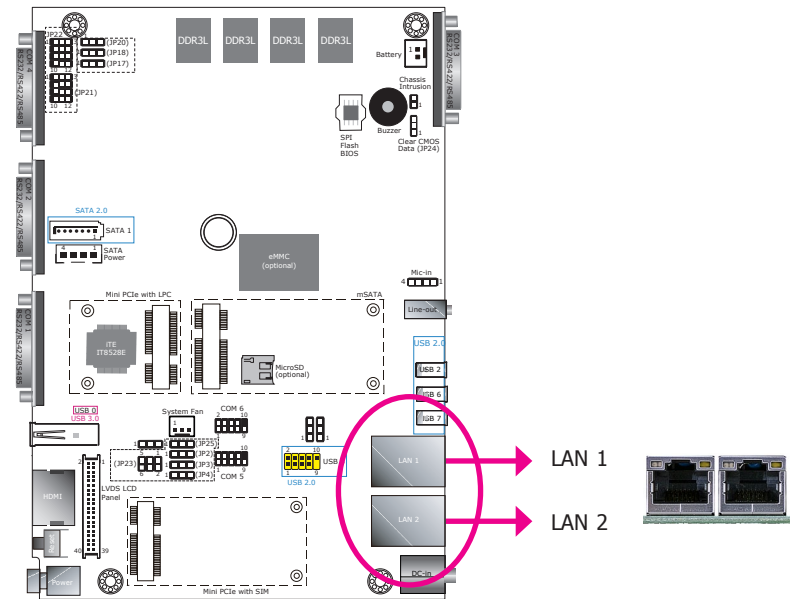

Features

- 2 Intel® I210AT PCI Express Gigabit Ethernet controllers

The LAN ports allow the system to connect to a local area network for Ethernet connectivity.

Driver Installation

Install the LAN drivers. Refer to Chapter 8 for more information.

Audio Output

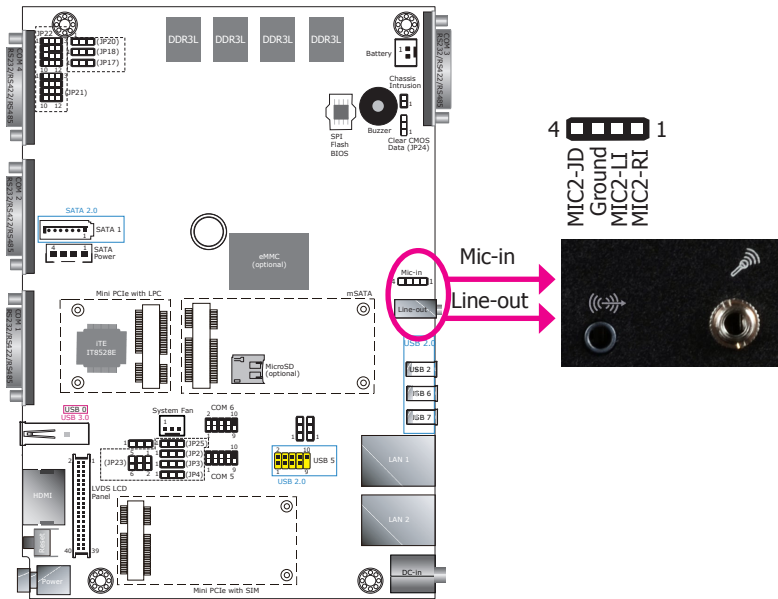

This Line-out jack is used to connect a headphone or external speakers. And the MIC-in connector is used to connect an external microphone. The audio ports are built based on the Realtek ALC888 chipset.

Driver Installation

Install the audio drivers. Refer to Chapter 8 for more information.

I/O Connectors

Serial ATA Connector

Serial ATA Power Connector

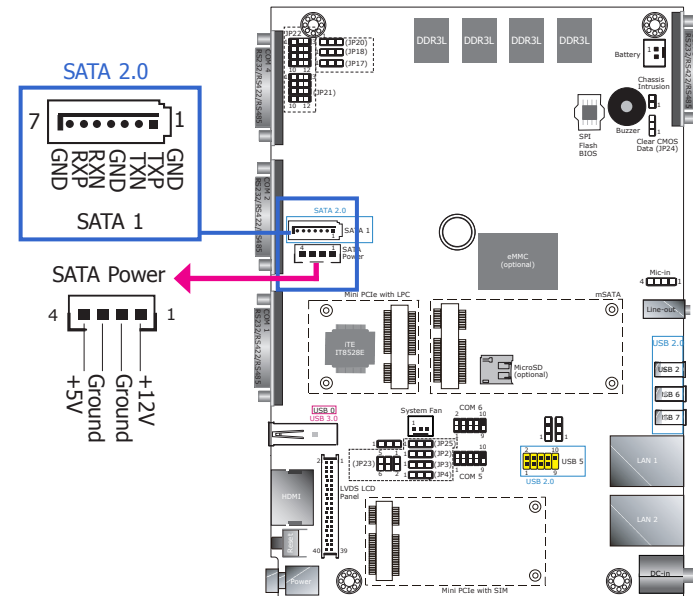

Features

- 1 Serial ATA 2.0 port with data transfer rate up to 3Gb/s
- Integrated Advanced Host Controller Interface (AHCI) controller

The Serial ATA connector is used to connect the Serial ATA device. Connect one end of the Serial ATA data cable to the SATA connector and the other end to your SATA device.

The SATA power connector supplies power to the SATA drive. Connect one end of the provided power cable to the SATA power connector and the other end to your SATA device.

BIOS Setting

Configure the Serial ATA drives in the Advanced menu ("SATA Configuration" submenu) of the BIOS. Refer to Chapter 7 for more information.

LVDS LCD Panel

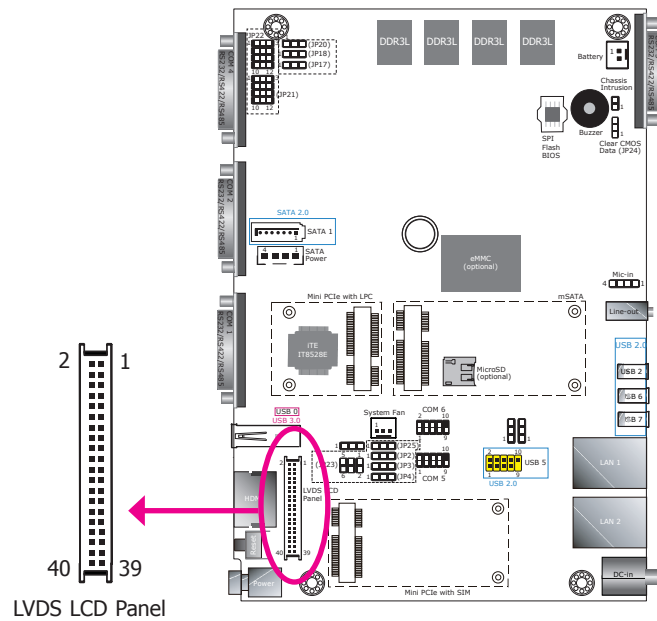

The system uses this connector as the output interface of the touch panel PC. It transmits video signals and power from the system board to the display panel.

Refer to the right side for the pin functions of the connector.

BIOS Setting

Configure the LCD panel in the Chipset menu ("North Bridge" submenu) of the BIOS. Refer to Chapter 7 for more information.

Pins	Function	Pins	Function
1	GND	2	GND
3	LVDS_Out3+ (Odd_3+)	4	LVDS_Out7+ (Even_3+)
5	LVDSA_DATA3N (Odd_3-)	6	LVDSB_DATA3N (Even_3-)
7	GND	8	GND
9	LVDSA_DATA2P (Odd_2+)	10	LVDSB_DATA2P (Even_2+)
11	LVDSA_DATA2N (Odd_2-)	12	LVDSB_DATA2N (Even_2-)
13	GND	14	GND
15	LVDSA_DATA1P (Odd_1+)	16	LVDSB_DATA1P (Even_1+)
17	LVDSA_DATA1N (Odd_1-)	18	LVDSB_DATA1N (Even_1-)
19	GND	20	GND
21	LVDSA_DATA0P (Odd_0+)	22	LVDSB_DATA0P (Even_0+)
23	LVDSA_DATA0N (Odd_0-)	24	LVDSB_DATA0N (Even_0-)
25	GND	26	GND
27	LVDSA_CLKP (Odd_CLK+)	28	LVDSB_CLKP (Even_CLK+)
29	LVDSA_CLKN (Odd_CLK-)	30	LVDSB_CLKN (Even_CLK-)
31	GND	32	GND
33	LVDS_DDC_CLK	34	Backlight_On_Off
35	LVDS_DDC_DATA	36	+3.3V
37	Backlight Power	38	Dimming
39	Backlight Power	40	Panel Power

Cooling Fan Connector

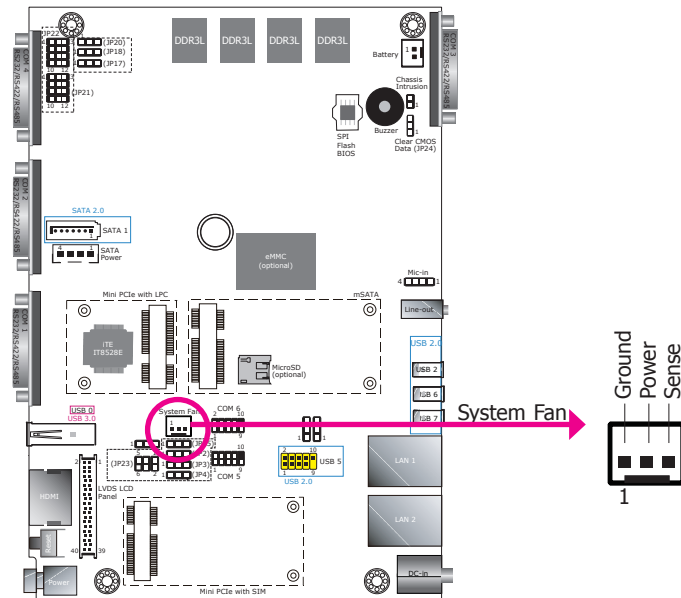

The fan connector is used to connect a cooling fan to provide airflow throughout the chassis.

Chassis Intrusion Connector

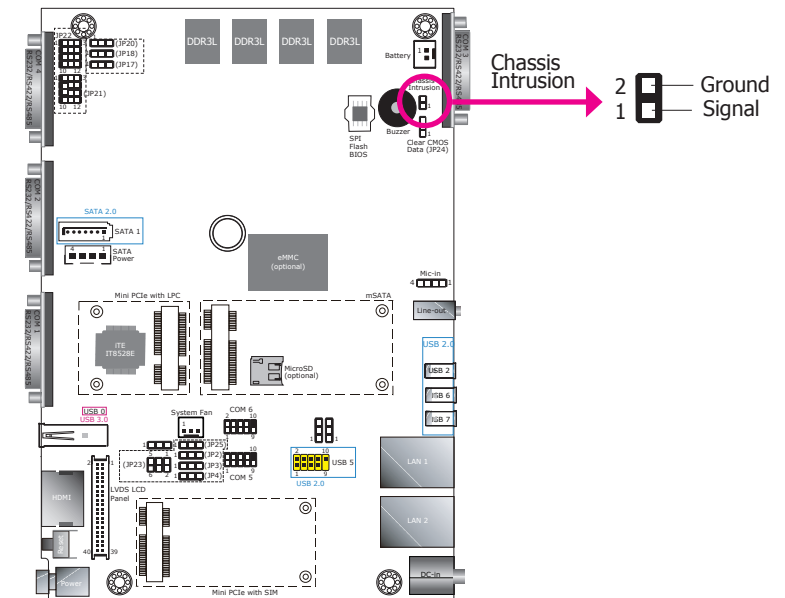

The board supports the chassis intrusion detection function. Connect the chassis intrusion sensor cable from the chassis to this connector. When the system's power is on and a chassis intrusion event occurs, an alarm will sound. When the system's power is off and a chassis intrusion event occurs, the alarm will sound only when the system restarts.

Expansion Slots

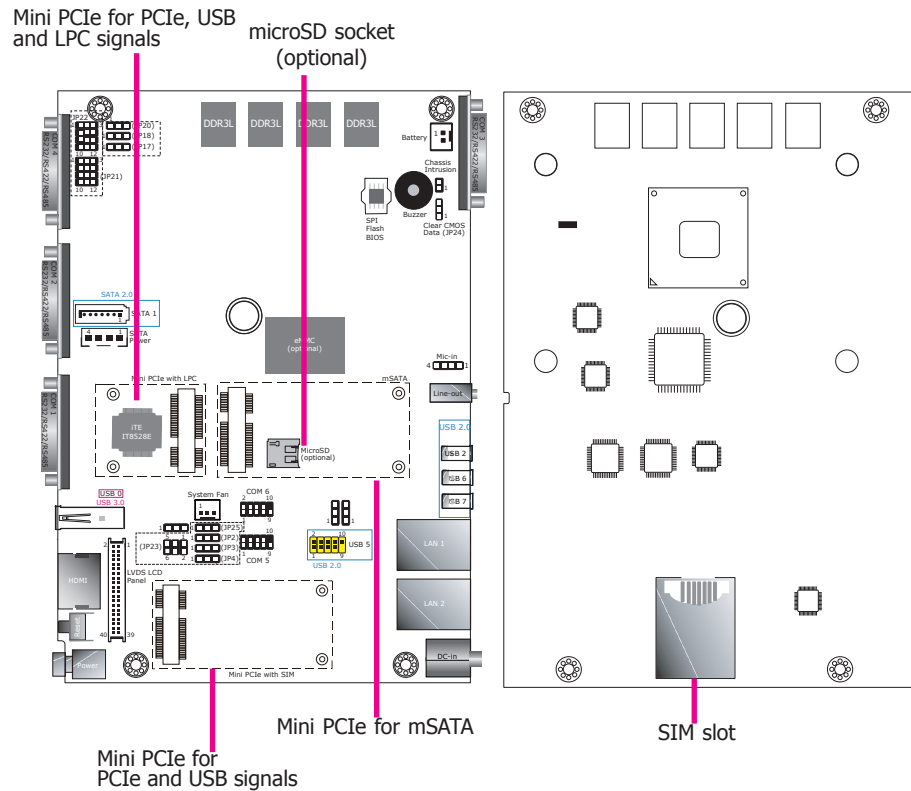

Mini PCI Express Slot with SIM Card Slot

Install a Mini PCIe card in this Mini PCIe slot (with PCIe and USB signals) to provide wireless network such as Wi-Fi or Bluetooth connectivity.

This slot can be used with or without the SIM slot (on the back side) to provide mobile 3G/4G connectivity.

Mini PCI Express Slots

Two other Mini PCI Express slots on the system board are used to install one half-size and one full-size Mini PCIe card. The full-size PCIe expansion card slot supports interfacing for mSATA signals whereas the half-size PCIe expansion card slot supports interfacing for LPC signals.

microSD Socket

The microSD socket allows you to install a microSD card for moderate expansion of the system's storage capacity.

Battery

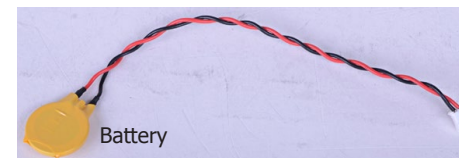
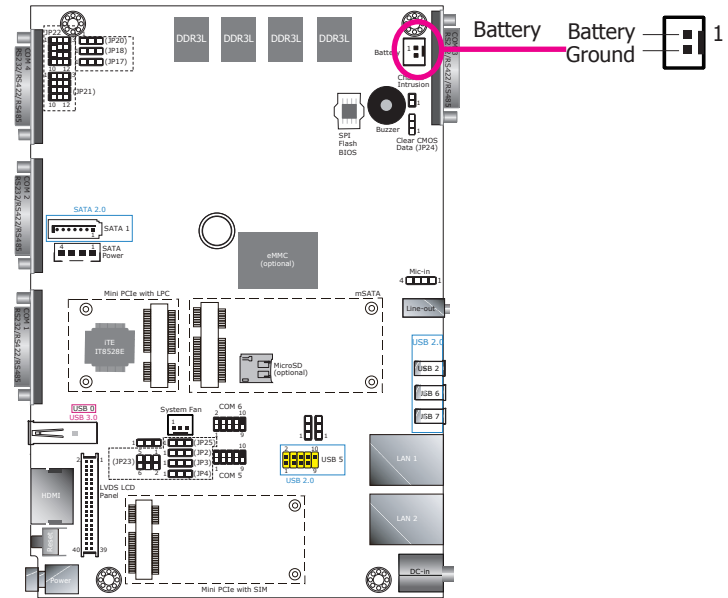

Connect to the battery connector

The lithium ion battery powers the real-time clock and CMOS memory. It is an auxiliary source of power when the main power is shut off.

Safety Measures

- Danger of explosion if battery incorrectly replaced.
- Replace only with the same or equivalent type recommend by the manufacturer.
- Dispose of used batteries according to local ordinance.

Chapter 6 - Mounting Options

Wall Mount

Note:

The system unit used in the following illustrations may not resemble the actual one. These illustrations are for reference only.

The wall mount kit includes the following:

- 2 wall mount brackets
- Bracket screws

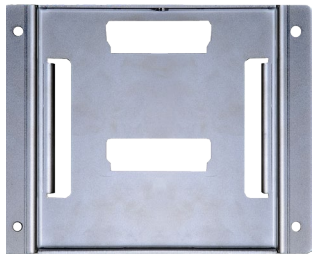

Wall mount bracket 1



Wall mount bracket 2

1. Before starting any installation procedures, attach the poron foam to the Panel PC.

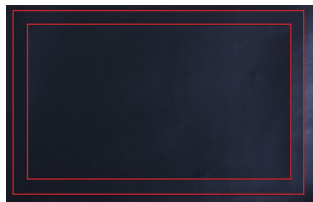

Poron foam



2. Select a place on the wall where you will mount the Panel PC.
3. Use the provided mounting screws to attach "wall mount bracket 1" to the wall.

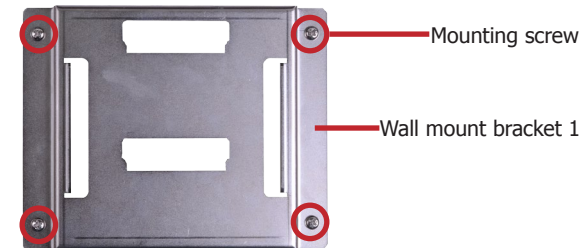

4. Attach the other bracket (wall mount bracket 2) to the rear of the Panel PC.

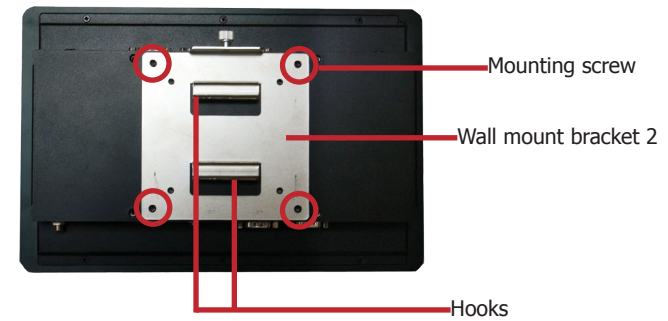

5. Slide the Panel PC to "wall mount bracket 1" to attach the two brackets with the hooks. Then tighten the screw to secure the assembly in place.

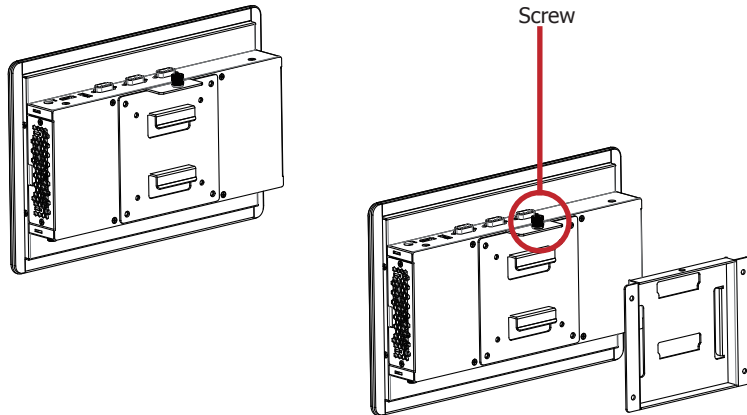

Panel Mount



Note:

The system unit used in the following illustrations may not resemble the actual one. These illustrations are for reference only.

The panel mounting kit includes the following:

- 6 mounting clamps



1. Before starting any installation procedures, attach the poron foam to the Panel PC.

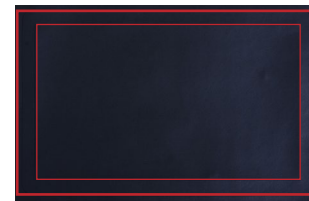

Poron foam



2. Select a place on the panel (or wall) where you will mount the Panel PC.
3. Cut out a shape on the panel that corresponds to the Panel PC's rear dimensions (272mm x 169mm) and ensure that the Panel PC can be fitted into the panel properly.

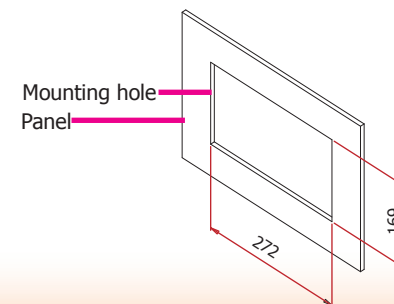

4. Insert the Panel PC from the outside surface of the panel into the mounting hole until it is properly fitted against the panel.
5. Position the mounting clamps along the rear edges of the Panel PC and insert them into the slits around the Panel PC.

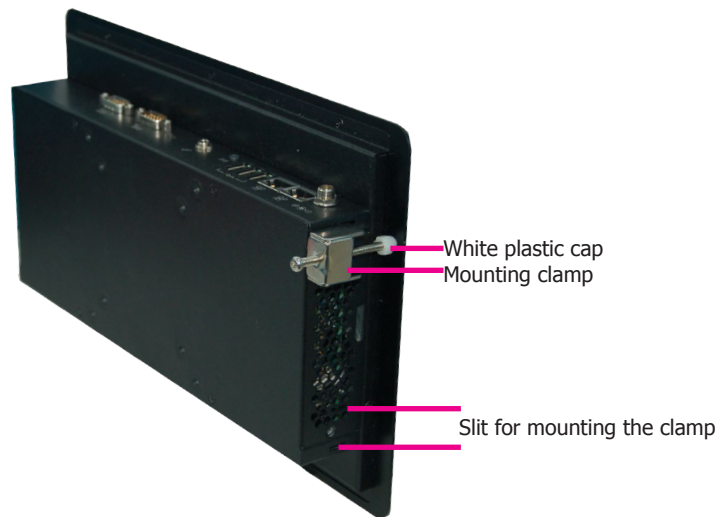

6. The first and second clamps must be positioned and secured diagonally prior to mounting the rest of the clamps. Tighten the clamp's screw using an electric screwdriver by pressing the white plastic cap onto the back of the panel. The illustration below shows that all clamps are properly mounted.

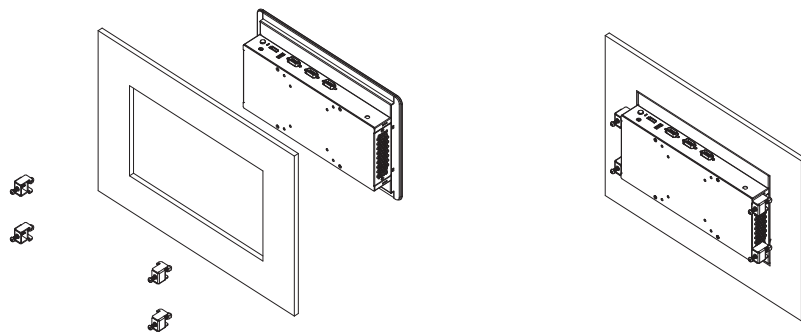
**Note:**

The maximum thickness of your panel's mounting wall should be 10 mm for secure panel mount.

Chapter 7 - BIOS Setup

Overview

The BIOS is a program that takes care of the basic level of communication between the CPU and peripherals. It contains codes for various advanced features found in this system board. The BIOS allows you to configure the system and save the configuration in a battery-backed CMOS so that the data retains even when the power is off. In general, the information stored in the CMOS RAM of the EEPROM will stay unchanged unless a configuration change has been made such as a hard drive replaced or a device added.

It is possible that the CMOS battery will fail causing CMOS data loss. If this happens, you need to install a new CMOS battery and reconfigure the BIOS settings.



Note:

The BIOS is constantly updated to improve the performance of the system board; therefore the BIOS screens in this chapter may not appear the same as the actual one. These screens are for reference purpose only.

Default Configuration

Most of the configuration settings are either predefined according to the Load Optimal Defaults settings which are stored in the BIOS or are automatically detected and configured without requiring any actions. There are a few settings that you may need to change depending on your system configuration.

Entering the BIOS Setup Utility

The BIOS Setup Utility can only be operated from the keyboard and all commands are keyboard commands. The commands are available at the right side of each setup screen.

The BIOS Setup Utility does not require an operating system to run. After you power up the system, the BIOS message appears on the screen and the memory count begins. After the memory test, the message "Press DEL to run setup" will appear on the screen. If the message disappears before you respond, restart the system or press the "Reset" button. You may also restart the system by pressing the <Ctrl> <Alt> and keys simultaneously.

Legends

Keys	Function
Right and Left arrows	Moves the highlight left or right to select a menu.
Up and Down arrows	Moves the highlight up or down between submenu or fields.
<Esc>	Exit to the BIOS Setup Utility.
+ (plus key)	Scrolls forward through the values or options of the highlighted field.
- (minus key)	Scrolls backward through the values or options of the highlighted field.
<F1>	Displays general help
<F2>	Pervious values
<F3>	Optimized defaults
<F4>	Saves and resets the setup program.
<Enter>	Press <Enter> to enter the highlighted submenu.

Scroll Bar

When a scroll bar appears to the right of the setup screen, it indicates that there are more available fields not shown on the screen. Use the up and down arrow keys to scroll through all the available fields.

Submenu

When "►" appears on the left of a particular field, it indicates that a submenu which contains additional options are available for that field. To display the submenu, move the highlight to that field and press <Enter>.

AMI BIOS Setup Utility

Main

The Main menu is the first screen that you will see when you enter the BIOS Setup Utility.

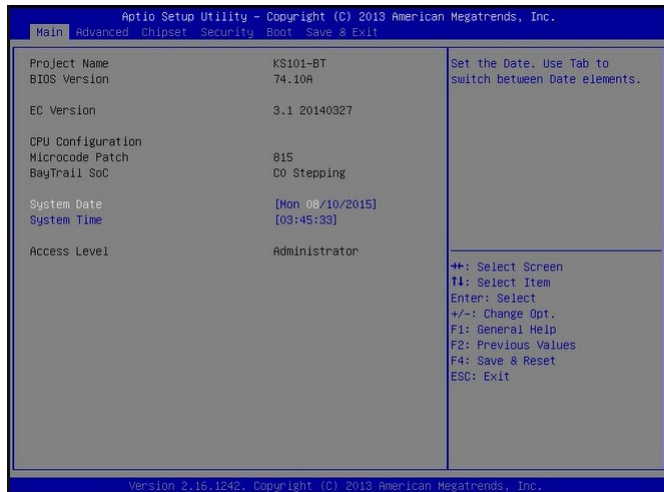

System Date

The date format is <day>, <month>, <date>, <year>. Day displays a day, from Sunday to Saturday. Month displays the month, from January to December. Date displays the date, from 1 to 31. Year displays the year, from 1980 to 2099.

System Time

The time format is <hour>, <minute>, <second>. The time is based on the 24-hour military-time clock. For example, 1 p.m. is 13:00:00. Hour displays hours from 00 to 23. Minute displays minutes from 00 to 59. Second displays seconds from 00 to 59.

Advanced

The Advanced menu allows you to configure your system for basic operation. Some entries are defaults required by the system board, while others, if enabled, will improve the performance of your system or let you set some features according to your preference.



Important:

Setting incorrect field values may cause the system to malfunction.

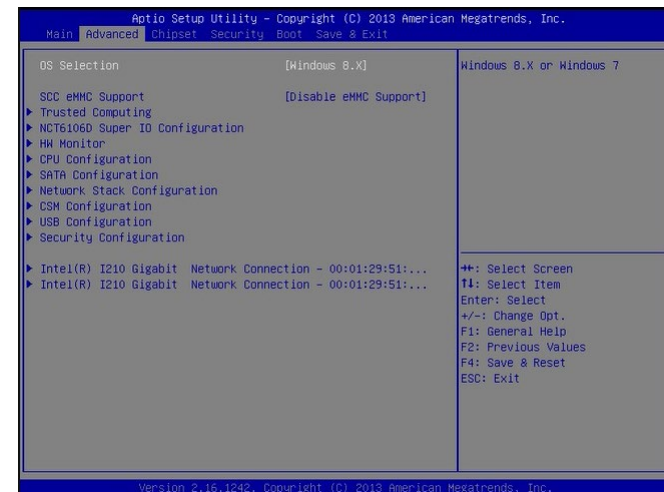

OS Selection

OS Selection: Windows 7 or Windows 8.X.

SoC eMMC Support: enable or disable CPU support for the eMMC. The eMMC is an optional device.

Trusted Computing

This section configures the system's support for the security device (i.e. TPM).

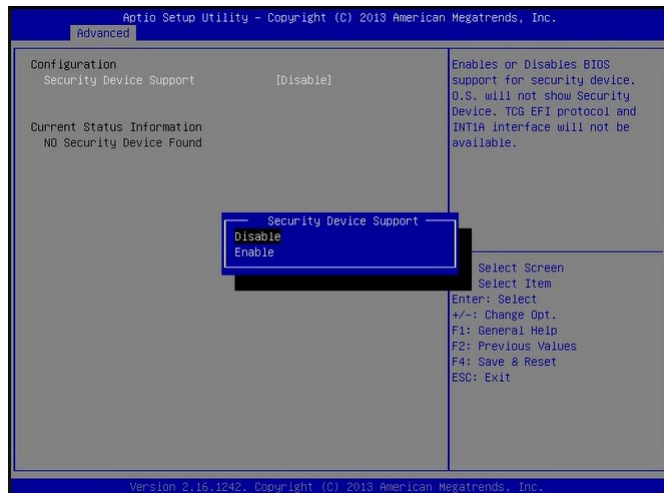

Security Device Support

Enable or disable the security device: Select Enabled to activate support for the Trusted Platform Module (TPM). If you select "Enabled", the available configurations for the TPM will be shown and its state will be altered according to the settings and operations on the TPM.

TPM State

Enable or disable the security device.

Pending operation

This field displays any TPM-related operation to be performed by the system.

Current Status Information

Status that indicates the current TPM State is as follows:

TPM Enabled Status

TPM Active Status

TPM Owner Status

NCT6106D Super IO Configuration

Sets the parameters of serial port 1 to serial port 6.

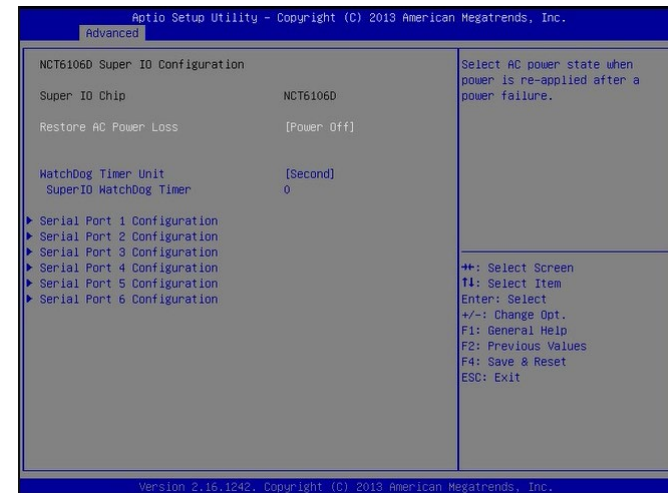

Restore AC Power Loss

Set the AC power loss to power-on or power-off. When set to power-off, the system's status will be power-off after an AC power loss event. When it is set to power-on, the system's status will be power-on after an AC power loss event.

WatchDog Timer Unit

Enable or disable the watchdog function. A counter will appear if you select to enable the WDT. Input any value between 1 to 255 in the "SuperIO WatchDog Timer" field.

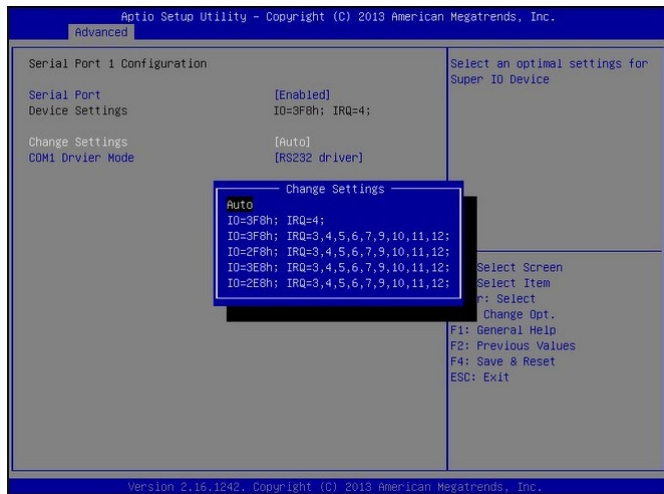

Serial Port 1-6 Configuration

Enable or disable each COM port.

Change Settings

Select the IO and IRQ address for each COM port.

COM Driver Mode

Set the serial communication mode for each COM port. This option is only available for COM Port 1 to 4.

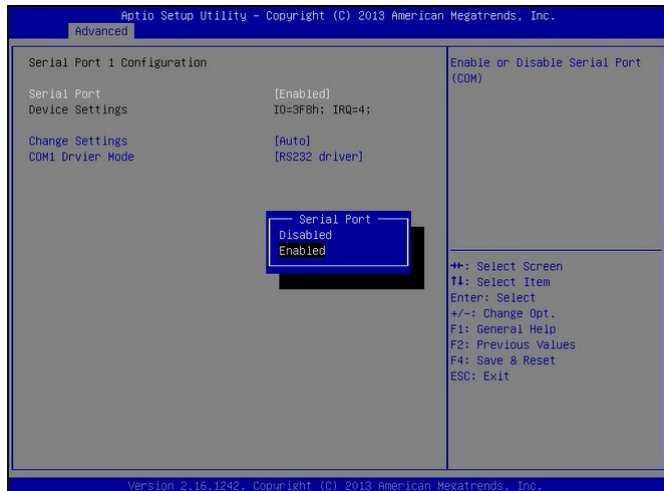

HW Monitor

This section shows system health information.

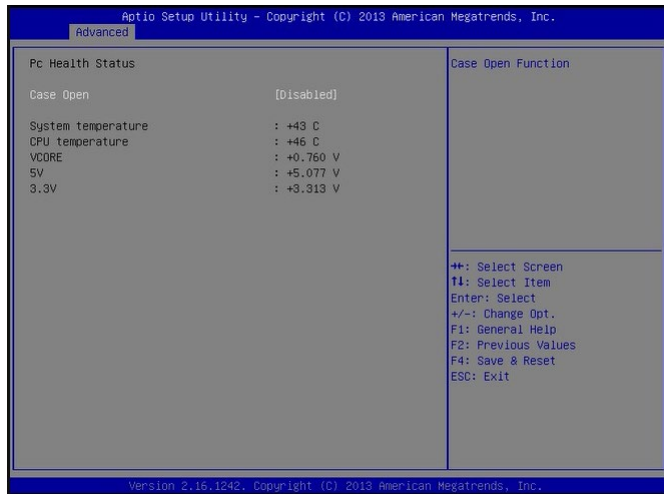

Case Open

Set this field to "Enabled" to allow the system to alert you of a chassis intrusion event.

CPU Configuration

This section configures the CPU. It will also display CPU information.

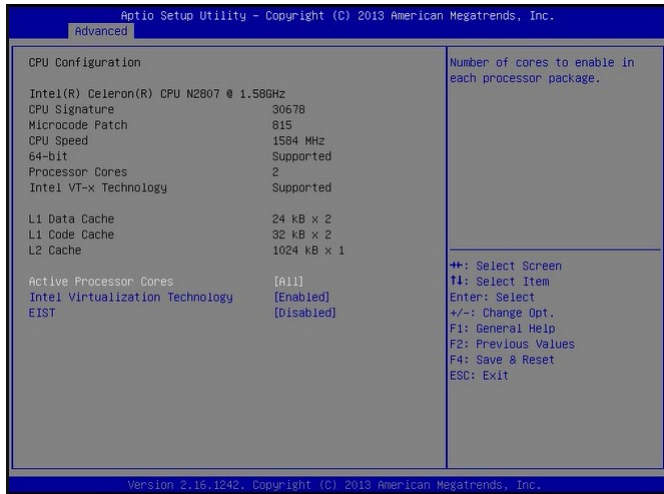

Active Processor Cores

Select "1" to use only one of the CPU's cores or "All" for all of the available cores.

Intel Virtualization Technology

Select "Enabled" to let the system utilize the hardware-assisted virtualization capabilities provided by Vanderpool Technology in a virtualized environment.

EIST

Enable or disable the Enhanced Intel SpeedStep® Technology (EIST), which helps optimize the balance between system's power consumption and performance. After it is enabled in the BIOS, you can enable the EIST feature using the operating system's power management.

SATA Configuration

This section configures SATA devices. It also shows the information about the installed SATA drives.

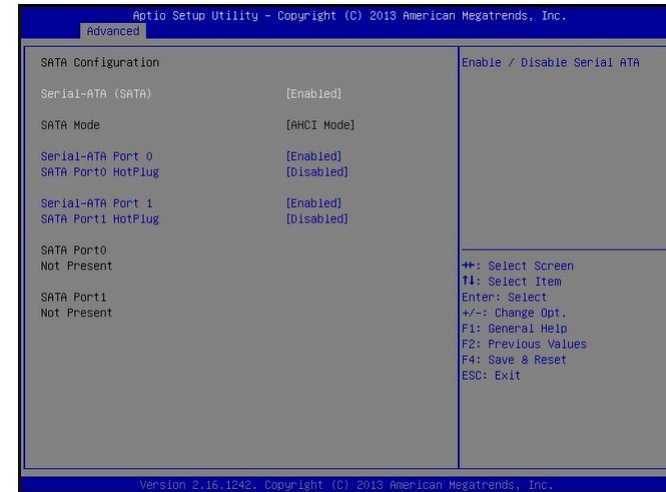

Serial-ATA (SATA)

Enable or disable Serial ATA devices.

Serial-ATA Port 0 and Port 1

Enable or disable Serial ATA port 0 and 1.

The SATA Port 0 controls the onboard SATA port.
The SATA Port 1 controls the Mini PCIe slot for mSATA (full size).

SATA Port HotPlug

Enable or disable hot-plugging for Serial-ATA port 0 and 1.

Network Stack Configuration

This section configures network stack settings.

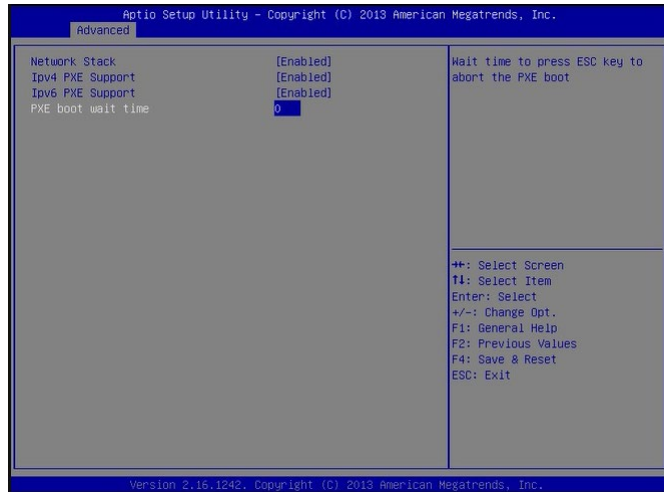

When the Network Stack is set to enabled, it will display the following information:

Ipv4 PXE Support

When enabled, PXE boot using IPv4 addressing scheme will be supported. When disabled, Ipv4 PXE boot option will not be supported.

Ipv6 PXE Support

When enabled, PXE boot using IPv6 addressing scheme will be supported. When disabled, Ipv6 PXE boot option will not be supported.

PXE boot wait time

Enter the wait time value to abort the PXE boot by pressing the "ESC" key.

CSM Configuration

This section configures the Compatibility Support Module (CSM) settings.

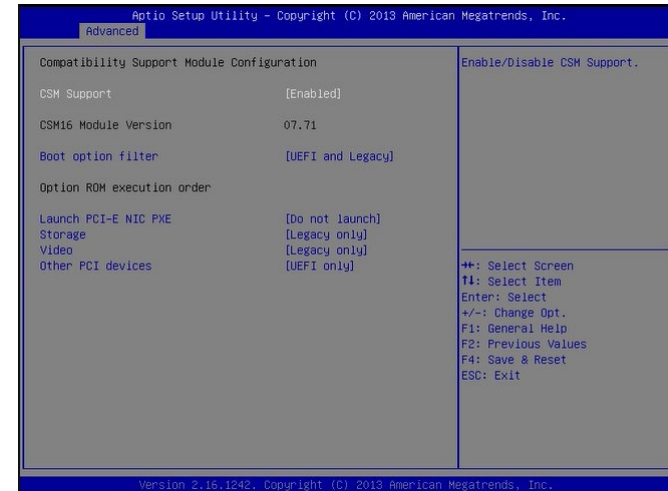

CSM Support

Enable or disable the CSM support.

Boot option filter

This option sets the boot options: Legacy, UEFI, or both. This setting will affect the boot options available for the "Boot Option Priorities" in the "Boot" menu.

Launch PCI-E NIC PXE

Enable or disable the execution of PXE Option ROM through network interfaces. If you choose to use UEFI boot, use the "Network Stack Configuration" menu instead.

Storage

Choose to allow the execution of UEFI, Legacy Storage Option ROM or none.

Video

Choose to allow the execution of UEFI, Legacy Video Option ROM or none.

Other PCI devices

Choose to set the Option ROM execution policy for devices other than network cards, storage or video devices.

USB Configuration

This section configures the parameters of USB devices.

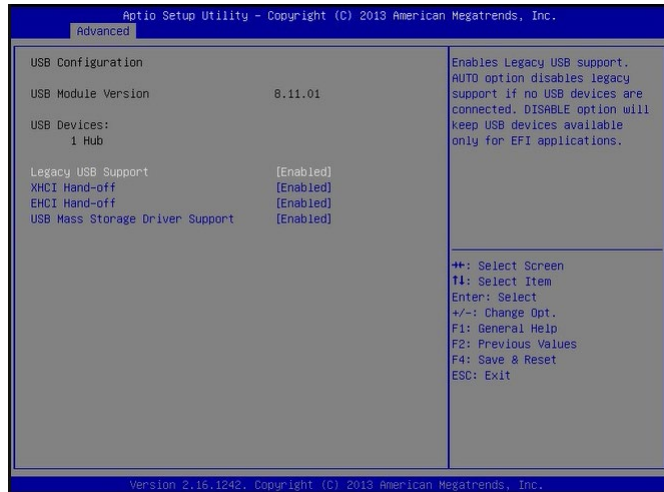

Legacy USB Support

Enabled

Enable legacy USB support.

Disabled

Keep USB devices available only for EFI applications.

Auto

Disable support for legacy when no USB devices are connected.

XHCI Hand-off

Enable this option for operating systems that do not support Extensible Host Controller Interface (xHCI) Hand-off. The XHCI ownership change will be claimed by the XHCI driver.

EHCI Hand-off

This item is for Operating Systems that do not support Enhanced Host Controller Interface (EHCI) Hand-off. When it is enabled, EHCI ownership change will be claimed by the EHCI driver.

USB Mass Storage Driver Support

Enable or disable the support of the USB Mass Storage Driver.



Important:

When installing Windows 7, only native USB 2.0 devices (USB port 0 to USB port 3) can operate under the DOS mode. Please refer to the following tables for more information on the type of USB ports.

Table 1. OS Selection

Operation Environment for Customers	DOS	Windows 7	Windows 8.x	Linux
OS Selection in the BIOS Advanced Menu	Windows 8.x	Windows 7	Windows 8.x	Windows 8.x
Available USB ports	All	When installing Windows 7 first time, only native USB 2.0 ports can work. Please refer to table 2 below for the USB type.	All	All

Table 2. The Type of USB Ports

Model Name	KS150-BT
USB 3.0	Native
USB 0	Native
USB 2	Native (share with USB 3.0 port)
USB 5	HSIC port 1
USB 6	HSIC port 2
USB 7	HSIC port 3

Security Configuration

This section configures the Intel® Trusted Execution Engine.

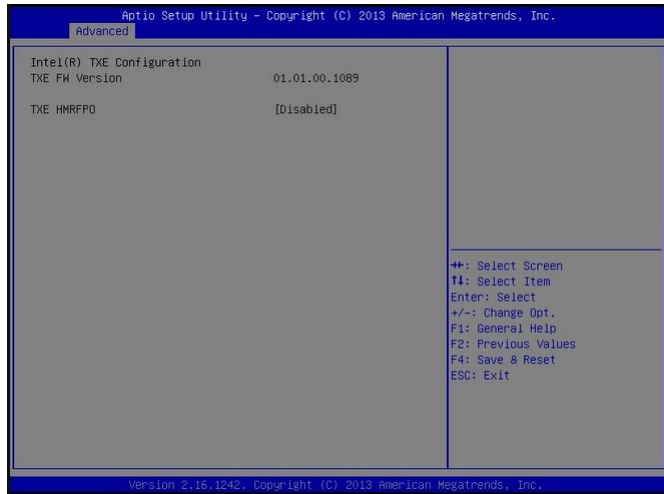

TXE HMRFPD

Select to enable or disable the Intel® Trusted Execution Engine.

Intel(R) I210 Gigabit Network Connection - 00:01:29:51:BA:1F

Intel(R) I210 Gigabit Network Connection - 00:01:29:51:BA:20

This section shows the network interface cards information and lets you enable some of their functions.

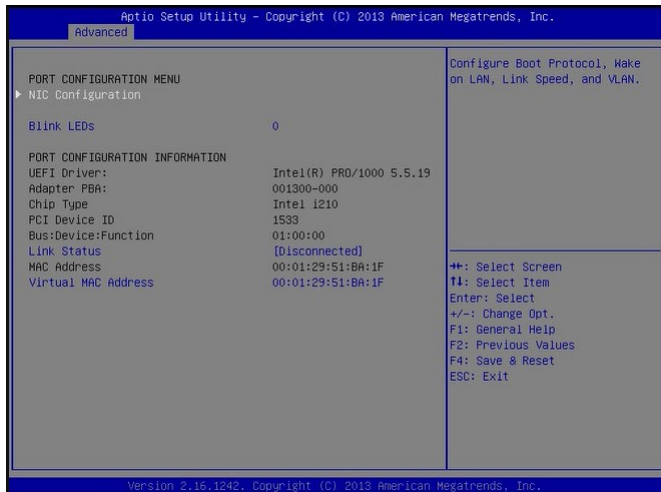

Blink LEDs

Enter the duration in seconds to blink the Activity/Link LED of this port to identify this physical port.

Link Status

This field indicates the Activity/Link status of this port.

Virtual MAC Address

This field indicates programmatically assignable MAC address for this network port.

NIC Configuration

This section configures network interface cards.

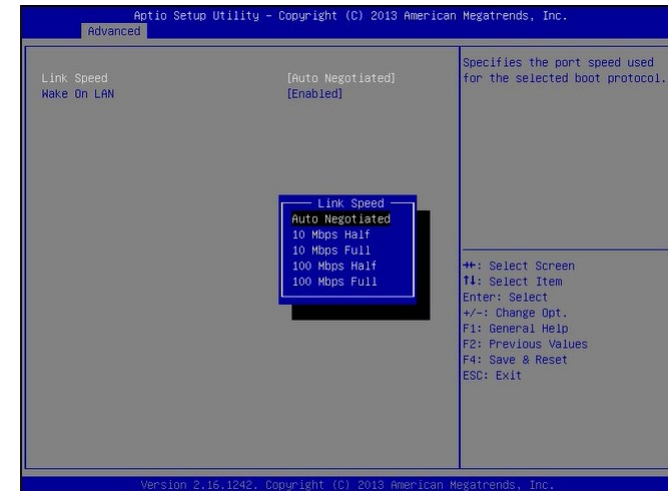

Link Speed

Specify the link speed of this network adapter.

Wake on LAN

Enable or disable remote power-on through this Ethernet port.

Chipset

This section configures the chipset functions.

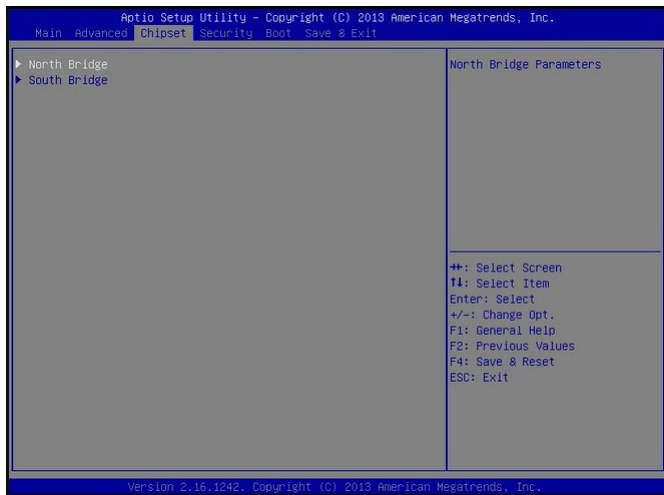

Select one of the following options to configure:

North Bridge

The items in the North Bridge include internal graphics device and memory.

South Bridge

The items in the South Bridge include USB controllers and PCI Express ports.

North Bridge

This section configures devices that belong to the North Bridge.



Select one of the following items to configure:

Intel IGD Configuration

This option lets you configure the internal graphics device.

Memory Configuration

It shows the system's memory information.

LCD Control

This section configures the LVDS functions for the internal graphics device.

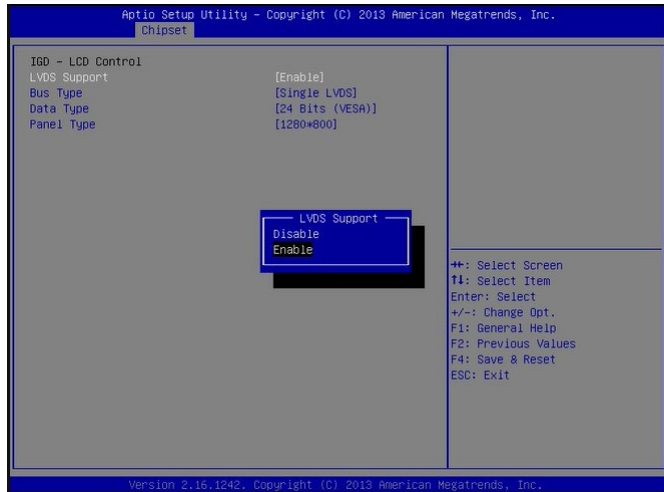

LVDS Support

Enable or disable the onboard LVDS function.

Bus Type

Select the bus type (single or dual channel) for the LVDS display.

Data Type

Select the data type for the LVDS display: 18 bits, 24 Bits, 24 Bits

Panel Type

Select the resolution for the LVDS display: 640*480, 800*600, 1280*800, 1280*1024, 1366*768, 1920*1200, or User Define.

Memory Configuration

This section displays the information of the installed memory modules.

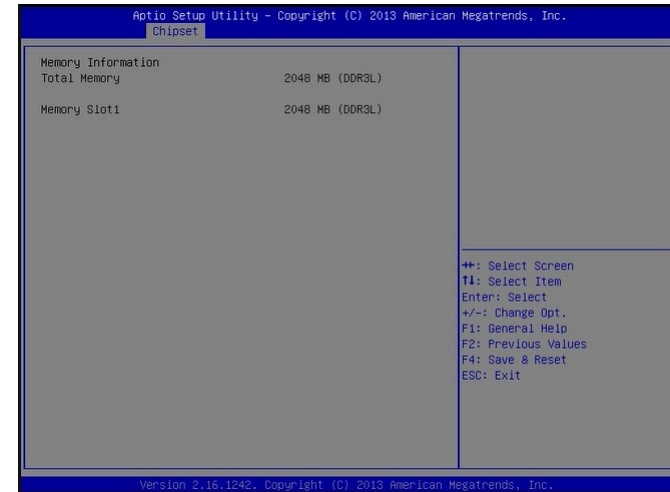

South Bridge

This section configures the South Bridge.

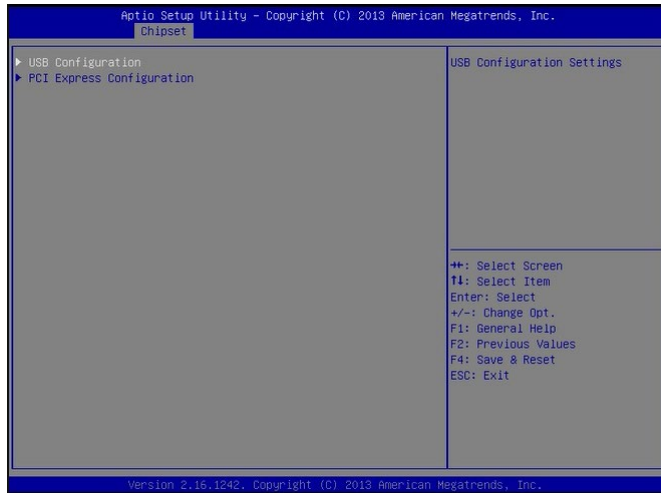

Select one of the following items to configure:

USB Configuration

This option lets you configure USB controllers.

PCI Express Configuration

This option lets you configure PCI Express root ports.

The PCI Express Port 2 controls the full-size Mini PCIe (for PCIe and USB signals) slot.
The PCI Express Port 3 controls the half-size Mini PCIe (for PCIe, USB and LPC signals) slot.

USB Configuration

This section displays the system's support for the USB controllers.

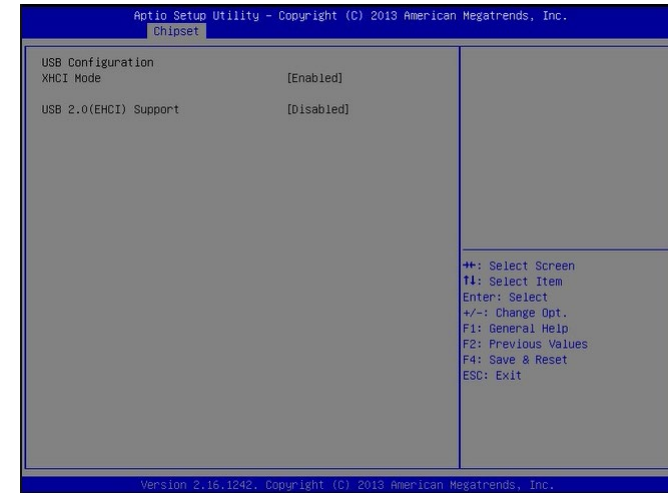

PCI Express Configuration

This section configures the PCI Express root ports.

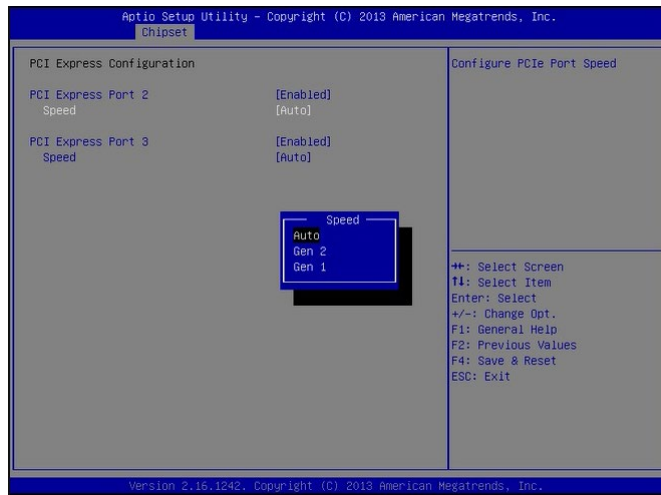

PCI Express Port 2 and 3

Enable or disable each PCI Express root port in the chipset.

Speed

Select the speed for the PCI Express port: Auto, Gen1 (2.5 GT/s) or Gen2 (5 GT/s).

Security

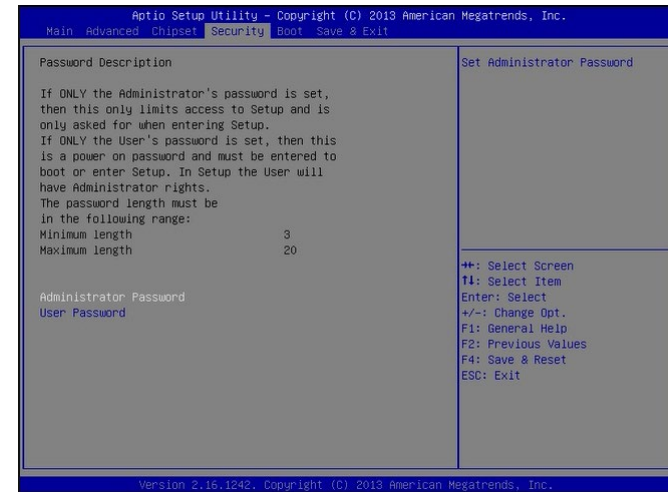

Administrator Password

Set the administrator password. The length of the password must be at least 3 characters and less than or equal to 20 characters. This password establishes the BIOS administrative privilege for entering the setup utility.

User Password

Set the user password. The length of the password must be at least 3 characters and less than or equal to 20 characters. Once it is set, you will be prompted for password upon entering power-on self-test (POST).

Boot

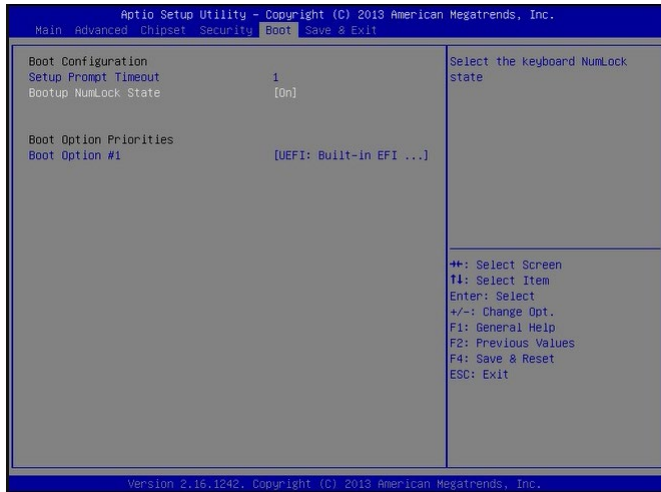

Setup Prompt Timeout

Select the number of seconds to wait for the setup activation key. 65535 (0xFFFF) denotes indefinite waiting.

Bootup NumLock State

This allows you to determine the default state of the numeric keypad at boot. By default, the system boots up with NumLock on. When set to Off, the function of the numeric keypad is the arrow keys.

Boot Option Priorities

This allows you to select detected devices to be the boot devices and the order of the devices from which the systems boots.

Save & Exit



Save Changes and Reset

To save the changes, select this field and then press <Enter>. A dialog box will appear. Select Yes to reset the system after saving all changes made.

Discard Changes and Reset

To discard the changes, select this field and then press <Enter>. A dialog box will appear. Select Yes to reset the system setup without saving any changes.

Restore Defaults

To restore and load the optimized default values, select this field and then press <Enter>. A dialog box will appear. Select "Yes" to restore the default values of all the setup options.

Boot Override

Select a boot device below to override a previously defined boot device in the "Boot" menu and boot the system with the selection.

Updating the BIOS

To update the BIOS, you will need an updated BIOS file and a flash utility, AFUDOS.EXE. Please contact technical support or your sales representative for the files.

To execute the utility, type:

```
A:> AFUDOS BIOS_File_Name /b /p /n
```

then press <Enter>.

```
C:\AFU\AFUDOS>afudos filename /B /P /N
+-----+
|              AMI Firmware Update Utility(APTIO) v2.25              |
|              Copyright (C)2008 American Megatrends Inc. All Rights Reserved.              |
+-----+
Reading file ..... done
Erasing flash ..... done
Writing flash ..... done
Verifying flash ..... done
Erasing BootBlock ..... done
Writing BootBlock ..... done
Verifying BootBlock ..... done
C:\AFU\AFUDOS>
```

Notice: BIOS SPI ROM

1. The Intel® Management Engine has already been integrated into this system board. Due to safety concerns, the BIOS (SPI ROM) chip cannot be removed from this system board and used on another system board of the same model.
2. The BIOS (SPI ROM) on this system board must be the original equipment from the factory and cannot be used to replace one which has been utilized on other system boards.
3. If you do not follow the methods above, the Intel® Management Engine will not be updated and will cease to be effective.

Note:



- a. You can take advantage of flash tools to update the default configuration of the BIOS (SPI ROM) to the latest version anytime.
- b. When the BIOS IC needs to be replaced, you have to populate it properly onto the system board after the EEPROM programmer has been burned and follow the technical person's instructions to confirm that the MAC address should be burned or not.

Chapter 8 - Supported Software

The CD that came with the system board contains drivers, utilities and software applications required to enhance the performance of the system board.

Insert the CD into a CD-ROM drive. The auto-run screen (Mainboard Utility CD) will appear. If the "Autorun" does not automatically start, please go directly to the root directory of the CD and double-click "Setup".

Auto Run Page (For Windows 10)



Auto Run Page (For Windows 8.1)

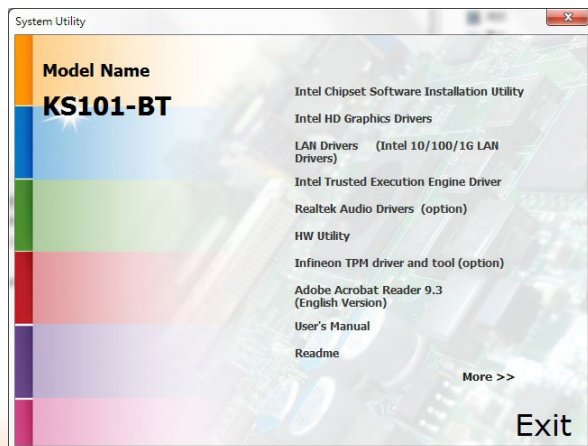

Auto Run Page (For Windows 7)

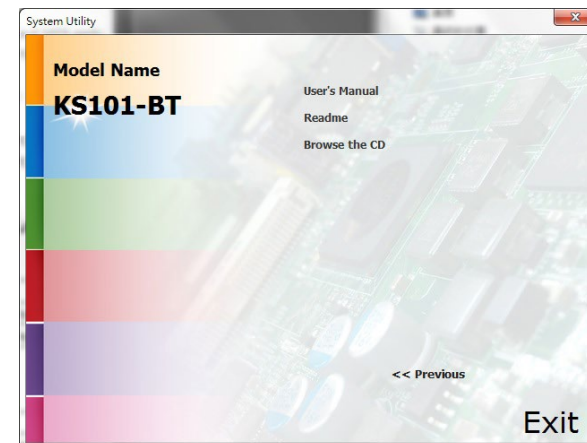
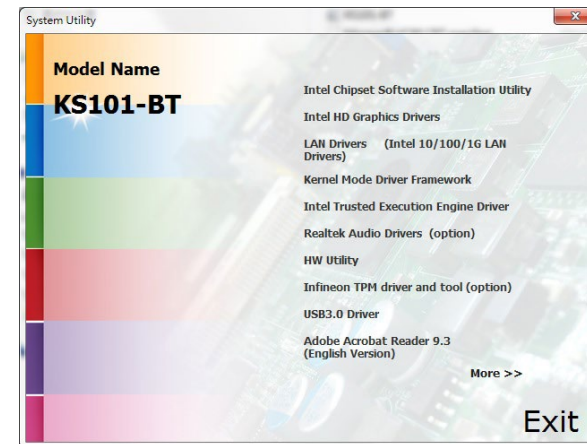

Intel Chipset Software Installation Utility

The Intel Chipset Device Software is used for updating Windows® INF files so that the Intel chipset can be recognized and configured properly in the system.

To install the utility, click "Intel Chipset Software Installation Utility" on the main menu.

1. Setup is ready to install the utility. Click "Next" to continue.
2. Read the license agreement then click "Yes" if you accept the terms and conditions.



3. Go through the readme document for more installation tips then click "Next".



4. After the installation is complete, click "Next".

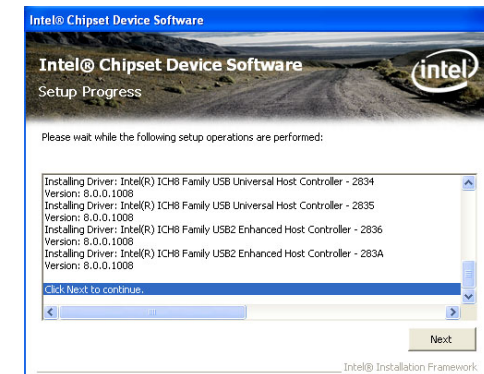

5. Click "Yes, I want to restart this computer now" then click "Finish" to exit the setup program.

Restarting the system will allow the new software installation to take effect.



Intel HD Graphics Drivers

To install the driver, click "Intel HD Graphics Drivers" on the main menu.

1. Setup is now ready to install the graphics driver. Click "Next" to continue.

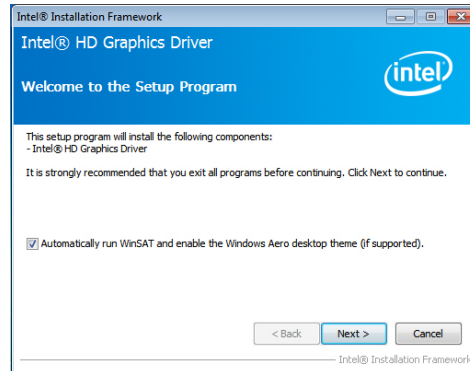

By default, the "Automatically run WinSAT and enable the Windows Aero desktop theme" is enabled. When this is enabled and the system reboots after driver installation, the screen will turn blank for 1 to 2 minutes (while WinSAT is running) before the Windows 7/ Windows 8 desktop appears. The "blank screen" period is the time Windows is testing the graphics performance.

We recommend that you skip this process by disabling this function and click "Next".

2. Read the license agreement then click "Yes" if you accept the terms and conditions.

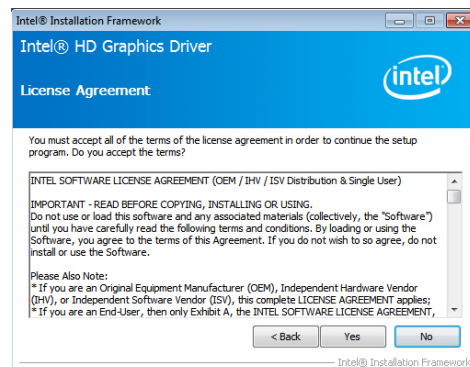

3. Go through the readme document for system requirements and installation tips then click "Next".

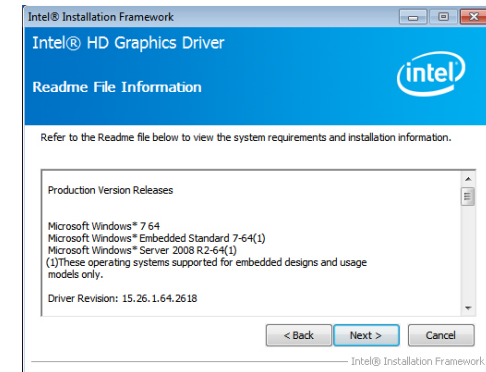

4. Setup is now installing the driver. Click "Next" to continue.

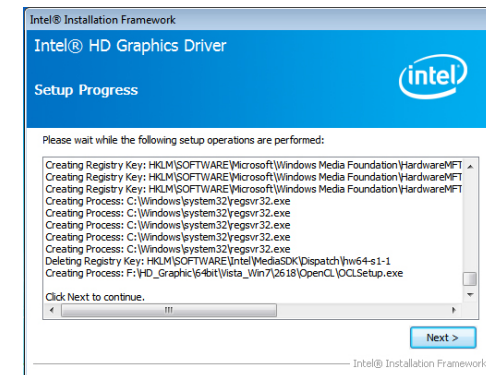

5. Click "Yes, I want to restart this computer now" then click "Finish" to exit the setup program.

Restarting the system will allow the new software installation to take effect.

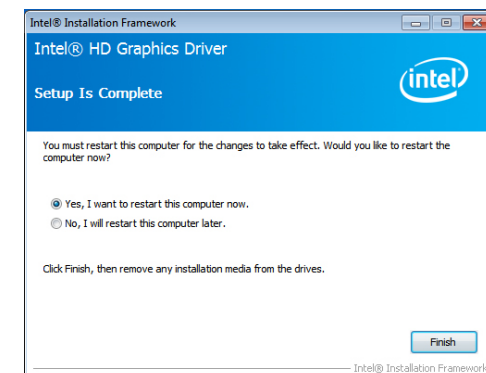

Intel LAN Drivers

To install the driver, click "LAN Drivers" on the main menu.

1. Setup is ready to install the driver. Click "Next" to continue.



2. Click "I accept the terms in the license agreement" if you accept the terms and conditions then click "Next".

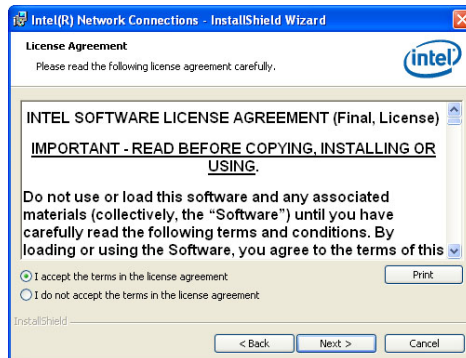

3. Select the program features you want to install then click "Next" to continue.

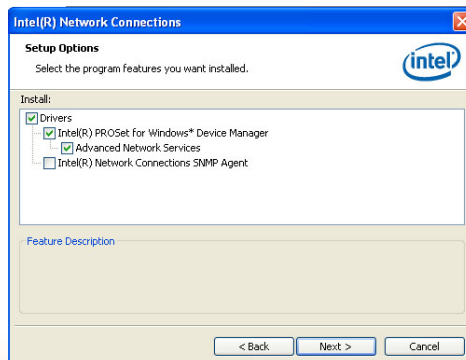

4. Click "Install" to begin the installation.

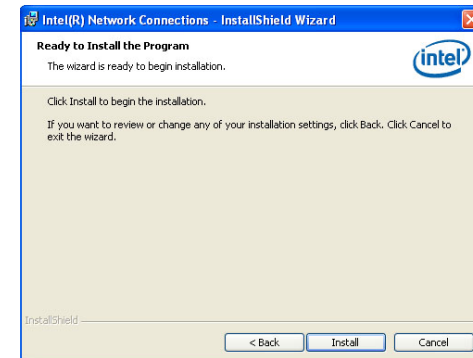

5. After the installation is complete, click "Finish" to exit the setup program.

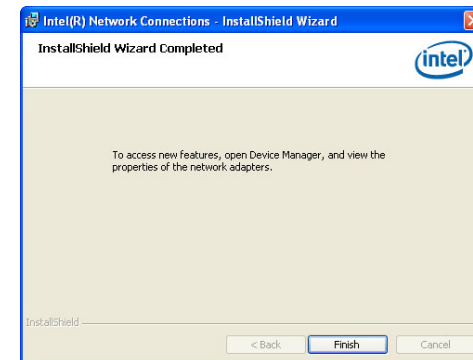

Kernel Mode Driver Framework (For Windows 7 only)

To install the driver, click "Kernel Mode Driver Framework" on the main menu.

1. Click "Yes" to install the update.

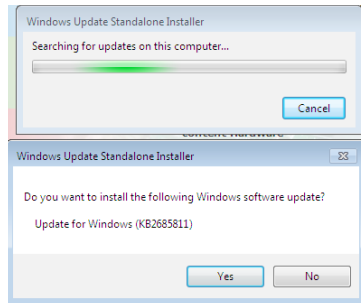

2. The update is being installed now.

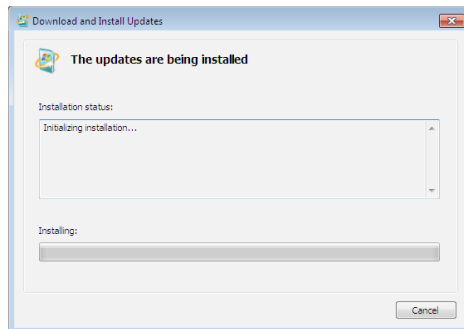

3. Click "Restart Now" to restart your computer after the installation is complete.

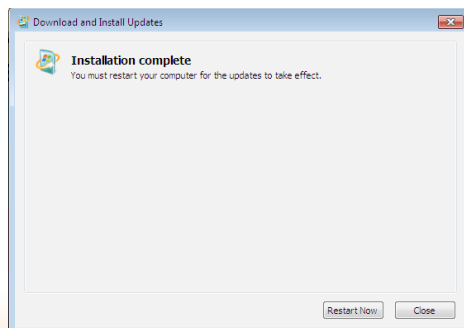

Intel Trusted Execution Engine Driver

To install the driver, click "Intel Trusted Execution Engine Driver" on the main menu.

1. Select "I accept the terms in the License Agreement" then click "Next."

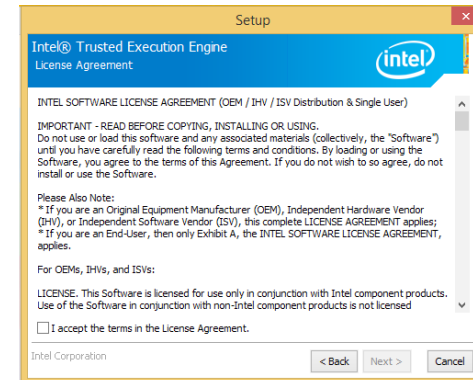

2. The screen shows the components that will be installed. Click "Next" to continue.

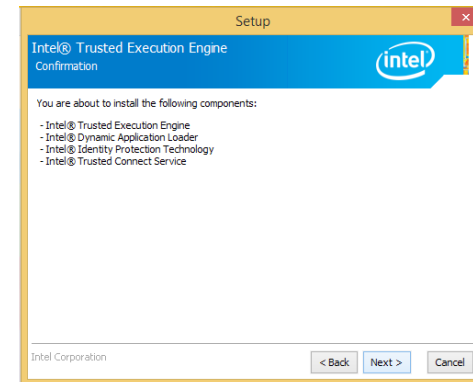

3. The screen displays the installation status in progress.

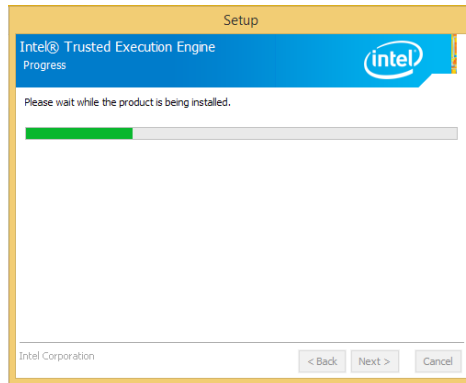

4. Click "Finish" when the installation is complete.

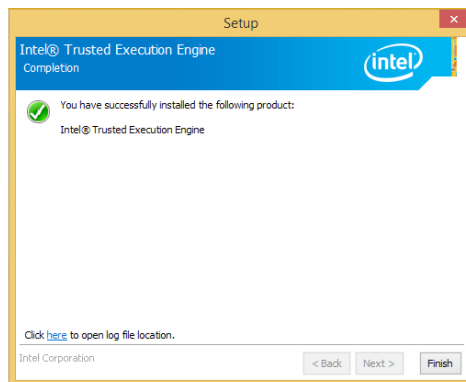

Realtek Audio Drivers

To install the driver, click "Realtek Audio Drivers" on the main menu.

1. Setup is now ready to install the audio driver. Click "Next".
2. Follow the on-screen instructions to proceed with the setup program. Click "Next" each time you finish a step.

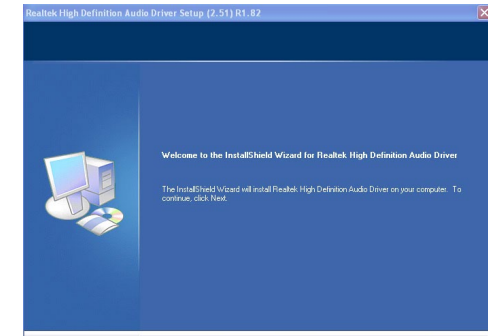

3. Click "Yes, I want to restart my computer now" then click "Finish".

Restarting the system will allow the new software installation to take effect.

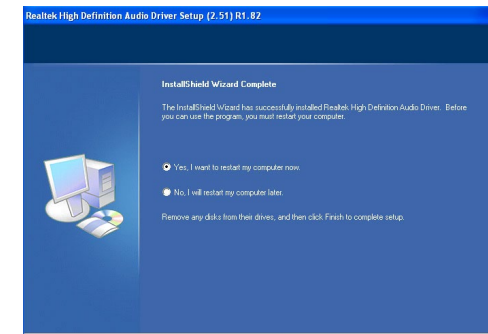

HW Utility

The DFI HW Utility provides hardware information about system health information, as well as configuration functions for Watchdog and DIO. To install this utility, click "HW Utility" on the main menu.



Note:

If you are using Windows 7 or later versions, you need to access the operating system as an administrator to be able to install the utility.

1. Setup is ready to install the HW Utility program. Click "Next" to continue.



2. Click "I accept the terms in the license agreement" then click "Next" to continue.

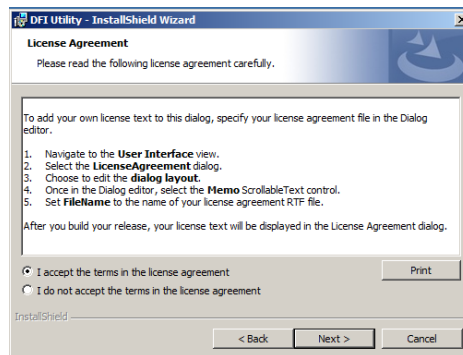

3. Click "Install" to begin the installation.

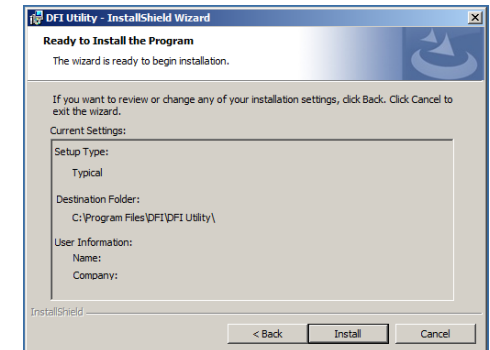

4. After the installation is complete, click "Finish" to exit the setup program.

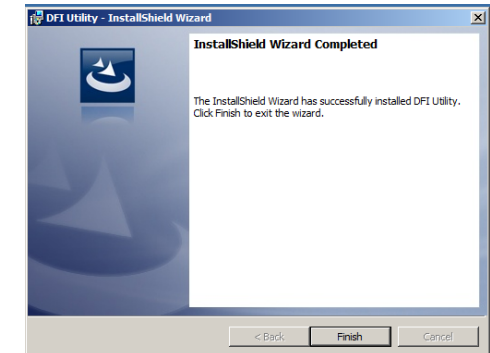

The HW Utility icon will appear on the desktop. Double-click the icon to open the utility.

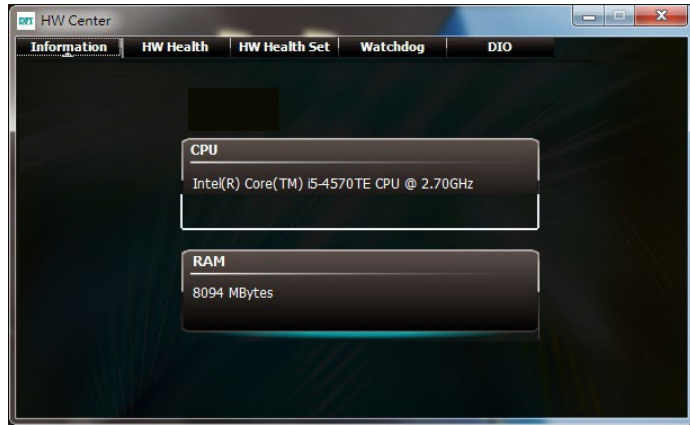

Information

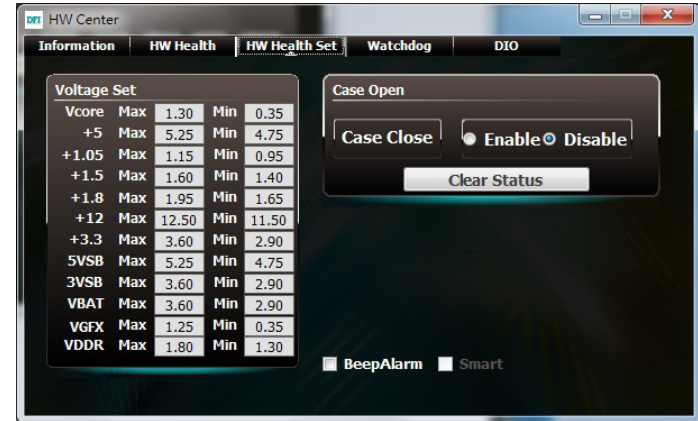

HW Health Set

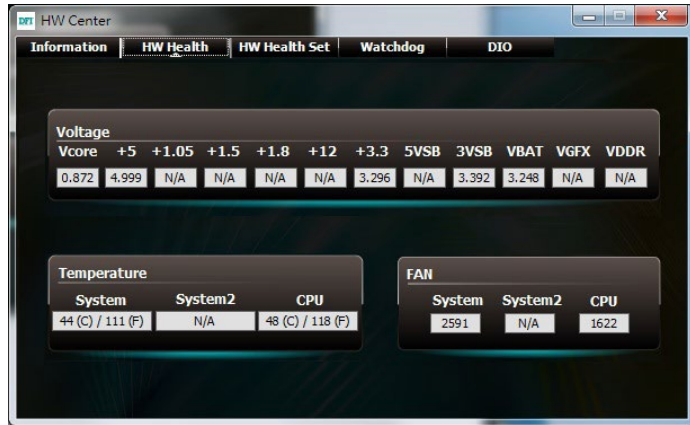

HW Health

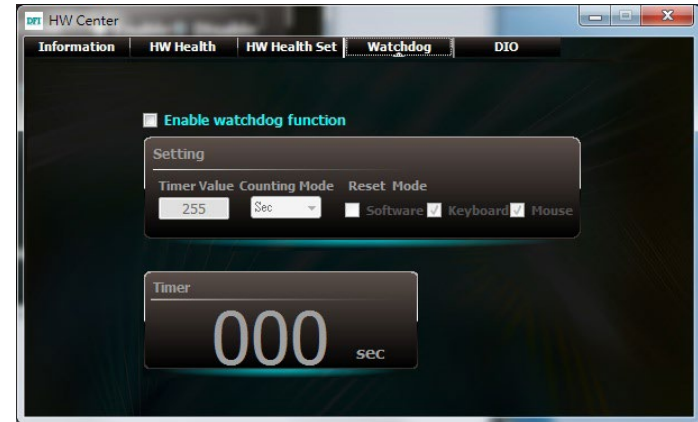

WatchDog

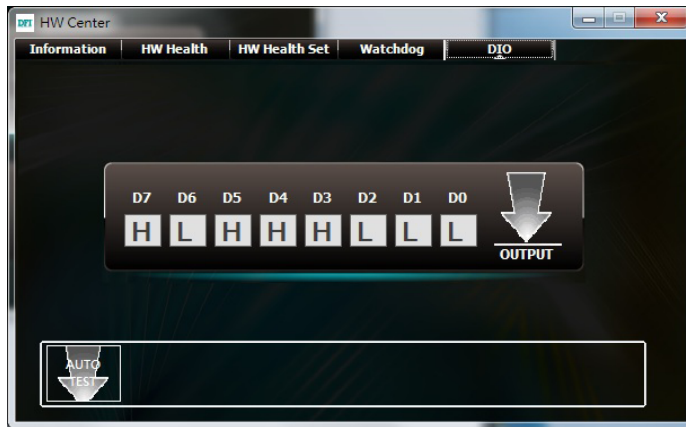

DIO

Infinion TPM Driver and Tool (optional)

To install the driver, click "Infinion TPM driver and tool (option)" on the main menu.

1. The setup program is preparing to install the driver.

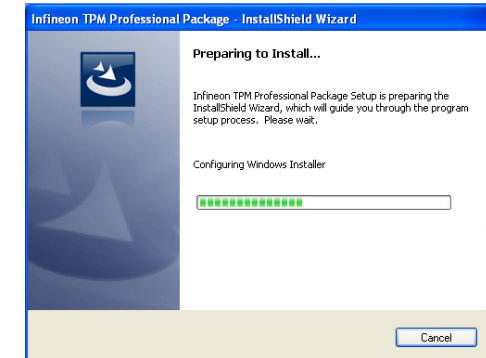

2. The setup program is now ready to install the utility. Click "Next" to continue.

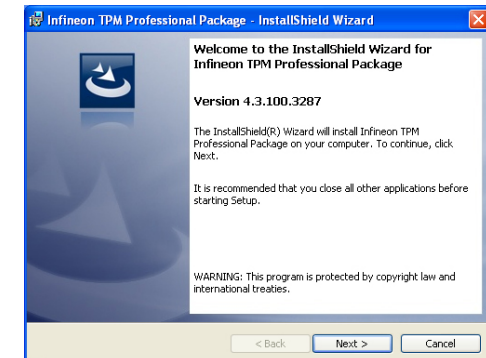

3. Click "I accept the terms in the license agreement" if you accept the agreement then click "Next".

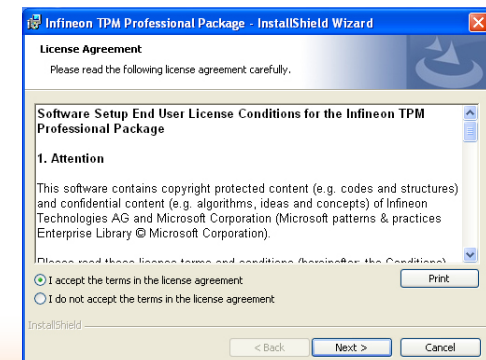

4. Enter the necessary information and click "Next".

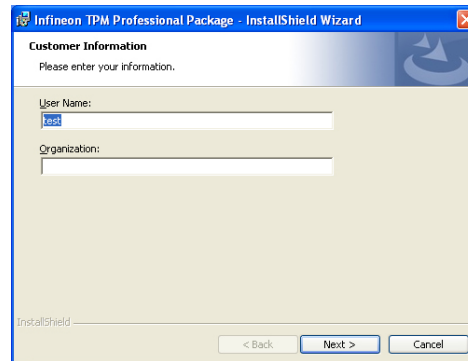

5. Select a setup type then click "Next".

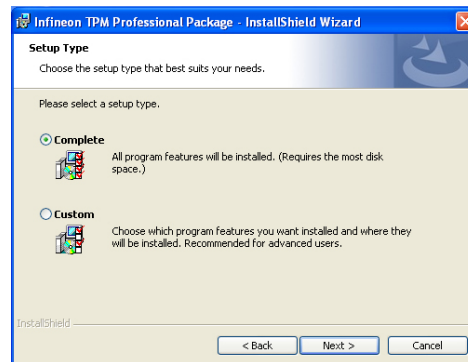

6. Click "Install" to start the installation.

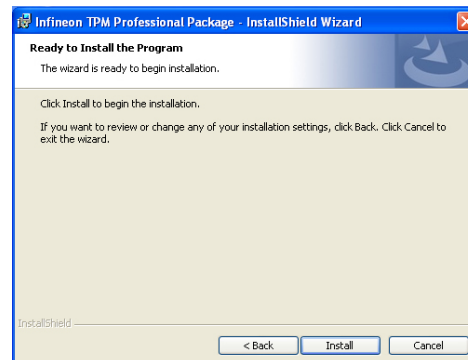

7. TPM requires installing the Microsoft Visual C++ package prior to installing the utility. Click "Install".

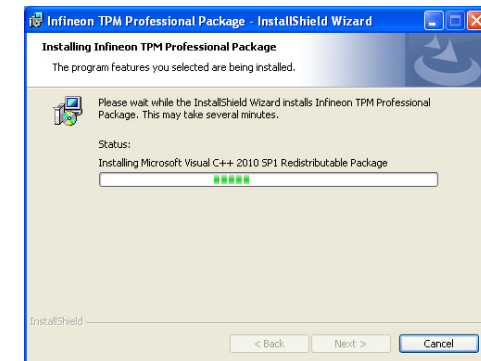

8. The setup program is currently installing the Microsoft Visual C++ package.

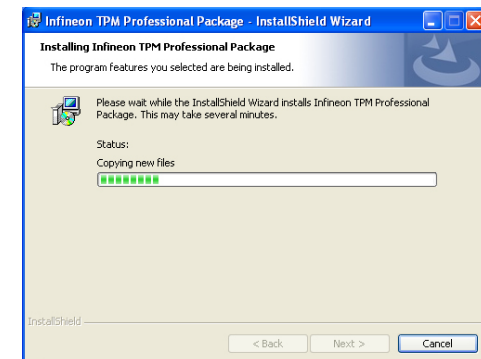

9. Click "Finish" to exit the setup program.

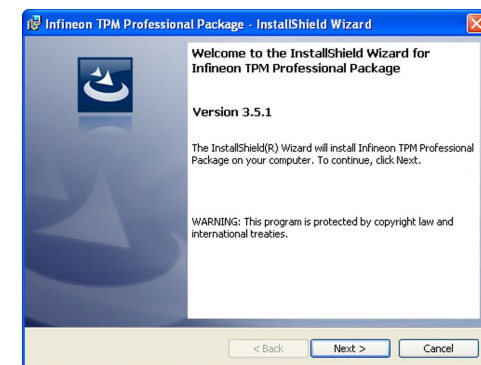

10. Click "Yes" to restart your system.

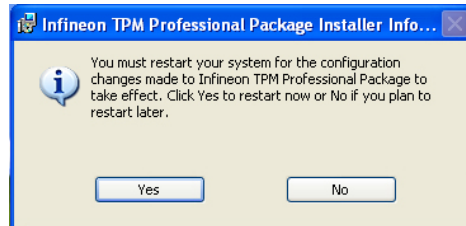

Intel USB 3.0 Drivers (For Windows 7 Only)

To install the driver, click "Intel USB 3.0 Driver" on the main menu.

1. Setup is ready to install the driver. Click "Next".

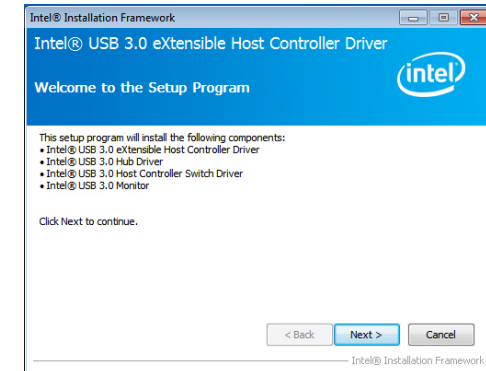

2. Read the license agreement then click "Yes".

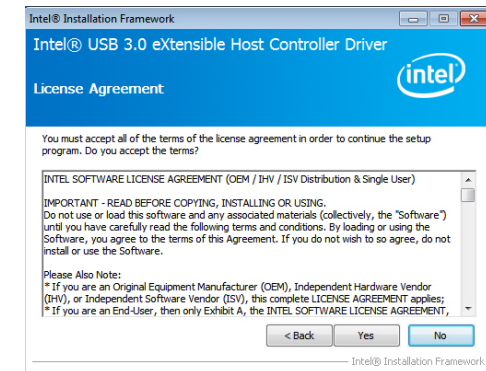

- Go through the readme document for more installation tips then click "Next".

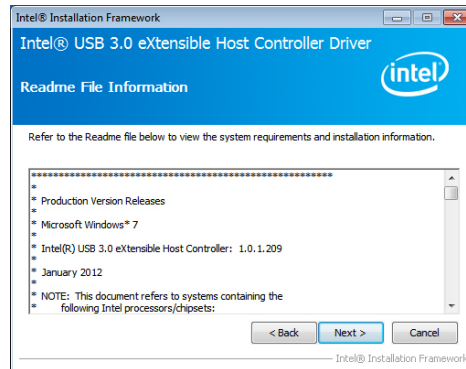

- Setup is currently installing the driver. After the installation is complete, click "Next".

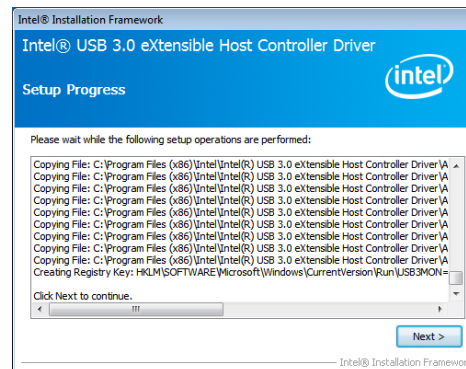

- Click "Finish".

Restarting the system will allow the new software installation to take effect.

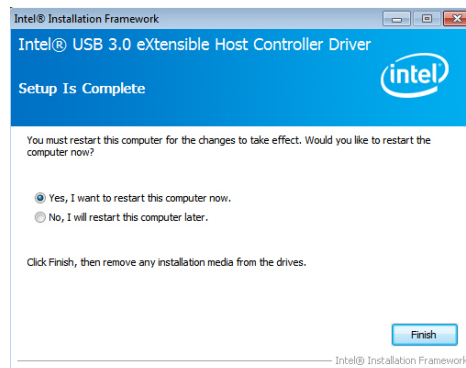

Adobe Acrobat Reader 9.3

To install the reader, click "Adobe Acrobat Reader 9.3" on the main menu.

- Click "Next" to install or click "Change Destination Folder" to select another folder.

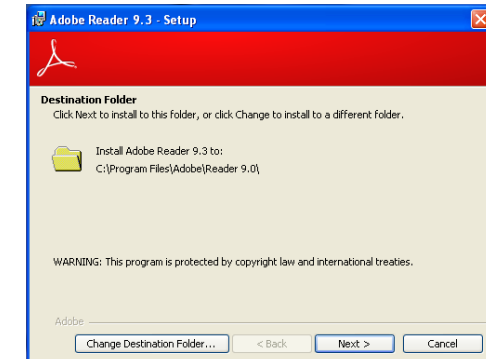

- Click "Install" to begin the installation.

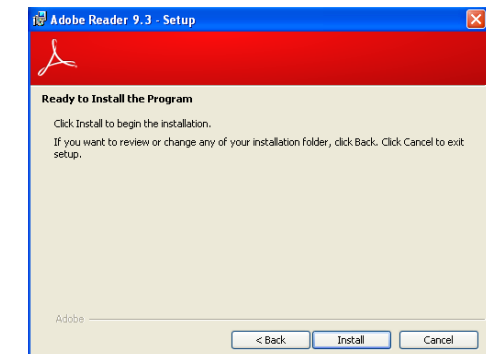

- Click "Finish" to exit the installation.

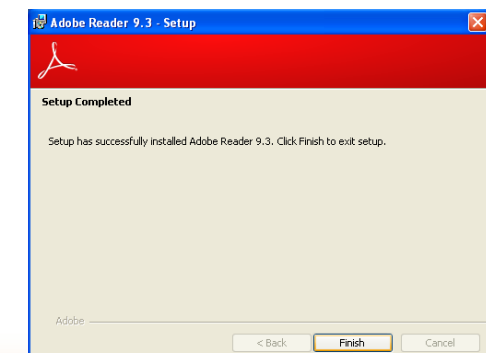

Appendix A - Watchdog Sample Code

;Software programming example:

```

;-----
;(1) Enter Super IO Configuration mode
;-----
MOV     DX,2EH
MOV     AL,87H
OUT     DX,AL
OUT     DX,AL

;-----
;(2) Configuration Logical Device 7, register CRF5/CRF6 (WDT Control /WDT
timer)
;-----
MOV     DX,2EH
MOV     AL,07H           ;Ready to Program Logical Device
OUT     DX,AL

MOV     DX,2FH
MOV     AL,07H           ;Select Logical Device 7
OUT     DX,AL

MOV     DX,2EH
MOV     AL, F6H           ;Select watchdog timer register
OUT     DX,AL

MOV     DX,2FH
MOV     AL,10H           ;Set watchdog timer value
OUT     DX,AL

MOV     DX,2EH
MOV     AL, F5H           ;Select watchdog Control Register
OUT     DX,AL

MOV     DX,2FH
MOV     AL,61H           ;Set Watchdog Control Value
OUT     DX,AL

;-----
;(1) Exit extended function mode
;-----
MOV     DX,2EH
MOV     AL,AAH
OUT     DX,AL

```

Appendix B - System Error Message

When the BIOS encounters an error that requires the user to correct something, either a beep code will sound or a message will be displayed in a box in the middle of the screen and the message, PRESS F1 TO CONTINUE, CTRL-ALT-ESC or DEL TO ENTER SETUP, will be shown in the information box at the bottom. Enter Setup to correct the error.

Error Messages

One or more of the following messages may be displayed if the BIOS detects an error during the POST. This list indicates the error messages for all Awards BIOSes:

CMOS BATTERY HAS FAILED

The CMOS battery is no longer functional. It should be replaced.



Important:

Danger of explosion if battery incorrectly replaced. Replace only with the same or equivalent type recommended by the manufacturer. Dispose of used batteries according to the battery manufacturer's instructions.

CMOS CHECKSUM ERROR

Checksum of CMOS is incorrect. This can indicate that CMOS has become corrupt. This error may have been caused by a weak battery. Check the battery and replace if necessary.

DISPLAY SWITCH IS SET INCORRECTLY

The display switch on the motherboard can be set to either monochrome or color. This indicates the switch is set to a different setting than indicated in Setup. Determine which setting is correct, either turn off the system and change the jumper or enter Setup and change the VIDEO selection.

Standard Status Codes

PEI Status Codes

0x11	Pre-memory CPU initialization is started
0x15	Pre-memory North Bridge initialization is started
0x19	Pre-memory South Bridge initialization is started
0x2A	OEM pre-memory initialization codes
0x2B	Memory initialization. Serial Presence Detect (SPD) data reading
0x2C	Memory initialization. Memory presence detection
0x2D	Memory initialization. Programming memory timing information
0x2E	Memory initialization. Configuring memory
0x2F	Memory initialization (other).

PEI Error Codes

0x50	Memory initialization error. Invalid memory type or incompatible memory speed
0x51	Memory initialization error. SPD reading has failed
0x52	Memory initialization error. Invalid memory size or memory modules do not match.
0x53	Memory initialization error. No usable memory detected

DXE Phase Codes

0x92	PCI Bus initialization is started
0x93	PCI Bus Hot Plug Controller Initialization
0x94	PCI Bus Enumeration
0x95	PCI Bus Request Resources
0x96	PCI Bus Assign Resources
0x99	Super IO Initialization
0x9A	USB initialization is started
0x9B	USB Reset
0x9C	USB Detect
0x9D	USB Enable
0xA0	IDE initialization is started
0xA1	IDE Reset
0xA2	IDE Detect
0xA3	IDE Enable
0xAE	Legacy Boot event
0xB4	USB hot plug
0xB6	Clean-up of NVRAM
0xB7	Configuration Reset (reset of NVRAM settings)

DXE Error Codes

0xD6	No Console Output Devices are found
0xD7	No Console Input Devices are found
0xD8	Invalid password

ACPI Checkpoints

0x03	System is entering S3 sleep state
0x04	System is entering S4 sleep state
0x05	System is entering S5 sleep state
0x30	System is waking up from the S3 sleep state
0x40	System is waking up from the S4 sleep state
0xAC	System has transitioned into ACPI mode. Interrupt controller is in PIC mode.
0xAA	System has transitioned into ACPI mode. Interrupt controller is in APIC mode.

Beep Code

6 beeps	Flash update is failed
---------	------------------------

Appendix C - Troubleshooting Checklist

Troubleshooting Checklist

This chapter of the manual is designed to help you with problems that you may encounter with your personal computer. To efficiently troubleshoot your system, treat each problem individually. This is to ensure an accurate diagnosis of the problem in case a problem has multiple causes.

Some of the most common things to check when you encounter problems while using your system are listed below.

1. The power switch of each peripheral device is turned on.
2. All cables and power cords are tightly connected.
3. The electrical outlet to which your peripheral devices are connected is working. Test the outlet by plugging in a lamp or other electrical device.
4. The monitor is turned on.
5. The display's brightness and contrast controls are adjusted properly.
6. All add-in boards in the expansion slots are seated securely.
7. Any add-in board you have installed is designed for your system and is set up correctly.

Monitor/Display

If the display screen remains dark after the system is turned on:

1. Make sure that the monitor's power switch is on.
2. Check that one end of the monitor's power cord is properly attached to the monitor and the other end is plugged into a working AC outlet. If necessary, try another outlet.
3. Check that the video input cable is properly attached to the monitor and the system's display adapter.
4. Adjust the brightness of the display by turning the monitor's brightness control knob.

The picture seems to be constantly moving.

1. The monitor has lost its vertical sync. Adjust the monitor's vertical sync.
2. Move away any objects, such as another monitor or fan, that may be creating a magnetic field around the display.
3. Make sure your video card's output frequencies are supported by this monitor.

The screen seems to be constantly wavering.

1. If the monitor is close to another monitor, the adjacent monitor may need to be turned off. Fluorescent lights adjacent to the monitor may also cause screen wavering.

Power Supply

When the computer is turned on, nothing happens.

1. Check that one end of the AC power cord is plugged into a live outlet and the other end properly plugged into the back of the system.
2. Make sure that the voltage selection switch on the back panel is set for the correct type of voltage you are using.
3. The power cord may have a "short" or "open". Inspect the cord and install a new one if necessary.

Floppy Drive

The computer cannot access the floppy drive.

1. The floppy diskette may not be formatted. Format the diskette and try again.
2. The diskette may be write-protected. Use a diskette that is not write-protected.
3. You may be writing to the wrong drive. Check the path statement to make sure you are writing to the targeted drive.
4. There is not enough space left on the diskette. Use another diskette with adequate storage space.

Hard Drive

Hard disk failure.

1. Make sure the correct drive type for the hard disk drive has been entered in the BIOS.
2. If the system is configured with two hard drives, make sure the bootable (first) hard drive is configured as Master and the second hard drive is configured as Slave. The master hard drive must have an active/bootable partition.

Excessively long formatting period.

If your hard drive takes an excessively long period of time to format, it is likely a cable connection problem. However, if your hard drive has a large capacity, it will take a longer time to format.

Serial Port

The serial device (modem, printer) doesn't output anything or is outputting garbled characters.

1. Make sure that the serial device's power is turned on and that the device is on-line.
2. Verify that the device is plugged into the correct serial port on the rear of the computer.
3. Verify that the attached serial device works by attaching it to a serial port that is working and configured correctly. If the serial device does not work, either the cable or the serial device has a problem. If the serial device works, the problem may be due to the onboard I/O or the address setting.
4. Make sure the COM settings and I/O address are configured correctly.

Keyboard

Nothing happens when a key on the keyboard was pressed.

1. Make sure the keyboard is properly connected.
2. Make sure there are no objects resting on the keyboard and that no keys are pressed during the booting process.

System Board

1. Make sure the add-in card is seated securely in the expansion slot. If the add-in card is loose, power off the system, re-install the card and power up the system.
2. Check the jumper settings to ensure that the jumpers are properly set.
3. Verify that all memory modules are seated securely into the memory sockets.
4. Make sure the memory modules are in the correct locations.
5. If the board fails to function, place the board on a flat surface and seat all socketed components. Gently press each component into the socket.
6. If you made changes to the BIOS settings, re-enter setup and load the BIOS defaults.