



SD330-H110

MicroATX Industrial Motherboard

User's Manual

Copyright

This publication contains information that is protected by copyright. No part of it may be reproduced in any form or by any means or used to make any transformation/adaptation without the prior written permission from the copyright holders.

This publication is provided for informational purposes only. The manufacturer makes no representations or warranties with respect to the contents or use of this manual and specifically disclaims any express or implied warranties of merchantability or fitness for any particular purpose. The user will assume the entire risk of the use or the results of the use of this document. Further, the manufacturer reserves the right to revise this publication and make changes to its contents at any time, without obligation to notify any person or entity of such revisions or changes.

Changes after the publication's first release will be based on the product's revision. The website will always provide the most updated information.

© 2018. All Rights Reserved.

Trademarks

Product names or trademarks appearing in this manual are for identification purpose only and are the properties of the respective owners.

FCC and DOC Statement on Class B

This equipment has been tested and found to comply with the limits for a Class B digital device, pursuant to Part 15 of the FCC rules. These limits are designed to provide reasonable protection against harmful interference when the equipment is operated in a residential installation. This equipment generates, uses and can radiate radio frequency energy and, if not installed and used in accordance with the instruction manual, may cause harmful interference to radio communications. However, there is no guarantee that interference will not occur in a particular installation. If this equipment does cause harmful interference to radio or television reception, which can be determined by turning the equipment off and on, the user is encouraged to try to correct the interference by one or more of the following measures:

- Reorient or relocate the receiving antenna.
- Increase the separation between the equipment and the receiver.
- Connect the equipment into an outlet on a circuit different from that to which the receiver is connected.
- Consult the dealer or an experienced radio TV technician for help.

Notice:

1. The changes or modifications not expressly approved by the party responsible for compliance could void the user's authority to operate the equipment.
2. Shielded interface cables must be used in order to comply with the emission limits.

Table of Contents

Copyright.....	2
Trademarks	2
FCC and DOC Statement on Class B.....	2
Warranty.....	4
Static Electricity Precautions.....	4
Safety Measures	4
About the Package.....	5
Optional Items.....	5
Before Using the System Board.....	5
Chapter 1 - Introduction.....	6
Specifications	6
Features.....	7
Chapter 2 - Hardware Installation.....	9
Board Layout.....	9
System Memory.....	9
Installing the DIMM Module	10
CPU	11
Installing the CPU.....	12
Installing the Fan and Heat Sink.....	14
Jumper Settings	15
Clear CMOS Data.....	15
COM1/COM2 RS232/422/485 Select.....	16
COM1/COM2 RS232/Power Select.....	17
Panel Power Select	18
LCD/Inverter Power Select	18
Backlight Power Select.....	19
USB Power Select	19
Rear Panel I/O Ports.....	20
PS/2 Keyboard/Mouse Port.....	20
COM (Serial) Ports.....	21
Graphics Interfaces.....	21
RJ45 LAN Ports.....	22

USB Ports.....	22
Audio	23
I/O Connectors	24
SATA (Serial ATA) Connectors.....	24
Digital I/O Connector	24
Cooling Fan Connectors.....	25
Power Connectors.....	25
LVDS LCD Panel Connector	26
LCD/Inverter Power Connector	26
Chassis Intrusion Connector	27
Front Panel Connector	27
Standby Power LED	28
S/PDIF Connector	28
SMBus Connector	29
LAN LED Connector	29
LPC Connector.....	30
Connecting the EXT-RS232/RS485 Card to the Motherboard	30
Expansion Slots	31
Battery.....	31

Chapter 3 - BIOS Setup..... 32

Overview.....	32
Insyde BIOS Setup Utility (for Intel 6th Generation CPU).....	33
Main	33
Advanced	33
Security.....	41
Boot.....	43
Exit.....	45
Insyde BIOS Setup Utility (for Intel 6/7th Generation CPU).....	46
Main	46
Advanced	46
Security.....	57
Boot.....	58
Exit.....	59
Updating the BIOS	60
Notice: BIOS SPI ROM	60

Chapter 4 - Supported Software..... 61

Appendix A - Troubleshooting Checklist..... 75

Warranty

1. Warranty does not cover damages or failures that arised from misuse of the product, inability to use the product, unauthorized replacement or alteration of components and product specifications.
2. The warranty is void if the product has been subjected to physical abuse, improper installation, modification, accidents or unauthorized repair of the product.
3. Unless otherwise instructed in this user's manual, the user may not, under any circumstances, attempt to perform service, adjustments or repairs on the product, whether in or out of warranty. It must be returned to the purchase point, factory or authorized service agency for all such work.
4. We will not be liable for any indirect, special, incidental or consequential damages to the product that has been modified or altered.

Static Electricity Precautions

It is quite easy to inadvertently damage your PC, system board, components or devices even before installing them in your system unit. Static electrical discharge can damage computer components without causing any signs of physical damage. You must take extra care in handling them to ensure against electrostatic build-up.

1. To prevent electrostatic build-up, leave the system board in its anti-static bag until you are ready to install it.
2. Wear an antistatic wrist strap.
3. Do all preparation work on a static-free surface.
4. Hold the device only by its edges. Be careful not to touch any of the components, contacts or connections.
5. Avoid touching the pins or contacts on all modules and connectors. Hold modules or connectors by their ends.



Important:

Electrostatic discharge (ESD) can damage your processor, disk drive and other components. Perform the upgrade instruction procedures described at an ESD workstation only. If such a station is not available, you can provide some ESD protection by wearing an antistatic wrist strap and attaching it to a metal part of the system chassis. If a wrist strap is unavailable, establish and maintain contact with the system chassis throughout any procedures requiring ESD protection.

Safety Measures

To avoid damage to the system:

- Use the correct AC input voltage range.

To reduce the risk of electric shock:

- Unplug the power cord before removing the system chassis cover for installation or servicing. After installation or servicing, cover the system chassis before plugging the power cord.

About the Package

The package contains the following items. If any of these items are missing or damaged, please contact your dealer or sales representative for assistance.

- One SD330-H110 motherboard
- One COM port cable (Length: 300mm, 2 x COM ports)
- One Serial ATA data cable (Length: 500mm)
- One I/O shield

The board and accessories in the package may not come similar to the information listed above. This may differ in accordance to the sales region or models in which it was sold. For more information about the standard package in your region, please contact your dealer or sales representative.

Optional Items

- USB port cable (Length: 350/398mm)
- COM port cable (Length: 300mm, 2 x COM ports)
- Serial ATA data cable (Length: 500mm)
- Thermal solution (For 35W, Height: 37.3mm)
- Thermal solution (For 65W, Height: 72.8mm)
- LPC EXT-RS232 module (4 x RS232 ports)
- LPC EXT-RS485 module (4 x RS485 ports)
- USB 3.0 port cable (Length: 320mm)

The board and accessories in the package may not come similar to the information listed above. This may differ in accordance to the sales region or models in which it was sold. For more information about the standard package in your region, please contact your dealer or sales representative.

Before Using the System Board

Before using the system board, prepare basic system components.

If you are installing the system board in a new system, you will need at least the following internal components.

- A CPU
- Memory module
- Storage devices such as hard disk drive, etc.

You will also need external system peripherals you intend to use which will normally include at least a keyboard, a mouse and a video display monitor.

Chapter 1 - Introduction

Specifications

SYSTEM	Processor	7th Generation Intel® Core™ Processors, LGA 1151 Socket Intel® Core™ i7-7700 Processor, Quad Core, 8M Cache, 3.6GHz (4.2GHz), 65W Intel® Core™ i7-7700T Processor, Quad Core, 8M Cache, 2.9GHz (3.8GHz), 35W Intel® Core™ i5-7500 Processor, Quad Core, 6M Cache, 3.4GHz (3.8GHz), 65W Intel® Core™ i5-7500T Processor, Quad Core, 6M Cache, 2.7GHz (3.3GHz), 35W Intel® Core™ i3-7101E Processor, Dual Core, 3M Cache, 3.9GHz, 54W Intel® Core™ i3-7101TE Processor, Dual Core, 3M Cache, 3.4GHz, 35W Intel® Celeron® Processor G3930E, Dual Core, 2M Cache, 2.9GHz, 54W Intel® Celeron® Processor G3930TE, Dual Core, 2M Cache, 2.7GHz, 35W 6th Generation Intel® Core™ Processors, LGA 1151 Socket Intel® Core™ i7-6700 Processor, Quad Core, 8M Cache, 3.4GHz (4.0GHz), 65W Intel® Core™ i7-6700TE Processor, Quad Core, 8M Cache, 2.4GHz (3.4GHz), 35W Intel® Core™ i5-6500 Processor, Quad Core, 6M Cache, 3.2GHz (3.6GHz), 65W Intel® Core™ i5-6500TE Processor, Quad Core, 6M Cache, 2.3GHz (3.3GHz), 35W Intel® Core™ i3-6100 Processor, Dual Core, 4M Cache, 3.7GHz, 65W Intel® Core™ i3-6100TE Processor, Dual Core, 4M Cache, 2.7GHz, 35W Intel® Pentium® Processor G4400, Dual Core, 3M Cache, 3.3GHz, 65W Intel® Pentium® Processor G4400TE, Dual Core, 3M Cache, 2.9GHz, 35W Intel® Celeron® Processor G3900, Dual Core, 2M Cache, 2.8GHz, 65W Intel® Celeron® Processor G3900TE, Dual Core, 2M Cache, 2.6GHz, 35W	
	Chipset	Intel® H110 Chipset	
	Memory	Two 288-pin DIMM up to 32GB Dual Channel DDR4 1866/2133MHz	
	BIOS	Insyde SPI 128Mbit	
	GRAPHICS	Controller	Intel® HD Gen 9 Graphics
	Feature	OpenGL 5.0, DirectX 12, OpenCL 2.1 HW Decode: AVC/H.264, MPEG2, VC1/WMV9, JPEG/MJPEG, HEVC/H265, VP8, VP9 HW Encode: MPEG2, AVC/H264, JPEG, HEVC/H265, VP8, VP9	
	Display	1 x VGA 1 x LVDS 1 x DVI-I (DVI-D signal) 1 x DP++	VGA: resolution up to 1920x1200 @ 60Hz LVDS: dual channel, resolution up to 1920x1200 @ 60Hz DVI-I (DVI-D signal): resolution up to 1920x1200 @ 60Hz DP++: resolution up to 4096x2160 @ 60Hz
	Dual Displays	VGA + LVDS VGA + DVI-I (DVI-D signal) VGA + DP++	LVDS + DVI-I (DVI-D signal) LVDS + DP++ DVI-I (DVI-D signal) + DP++
EXPANSION	Interface	1 x PCIe x16 (Gen 3) 1 x PCIe x4 (Gen 2) 2 x PCI	
AUDIO	Audio Codec	Realtek ALC888S-VD2-GR	
ETHERNET	Controller	1 x Intel® I211AT PCIe (10/100/1000Mbps) 1 x Intel® I219V PCIe (10/100/1000Mbps)	
REAR I/O	Ethernet	2 x GbE (RJ-45)	
	USB	4 x USB 3.0 2 x USB 2.0	
	Serial	1 x RS-232/422/485 (RS-232 w/ power) (DB-9)	

REAR I/O	PS/2	1 x PS/2 (mini-DIN-6)
	Display	1 x VGA 1 x DVI-I (DVI-D signal) 1 x DP++
	Audio	1 x Line-out 1 x Mic-in 1 x Line-in (available upon request)
INTERNAL I/O	Serial	1 x RS-232/422/485 (RS-232 w/ power) (2.54mm pitch) 4 x RS-232 (2.54mm pitch)
	USB	2 x USB 2.0 (2.54mm pitch) 1 x Vertical USB 2.0 (type A)
	Audio	1 x Audio (Line-out/Mic-in) (available upon request) 1 x S/PDIF
	SATA	4 x SATA 3.0 (up to 6Gb/s)
	DIO	1 x 8-bit DIO
	LPC	1 x LPC (supports LPC EXT-RS232/RS485 module)
	SMBus	1 x SMBus
	Display	1 x LVDS LCD Panel Connector 1 x LCD/Inverter Power
WATCHDOG TIMER	Output & Interval	System Reset, Programmable via Software from 1 to 255 Seconds
SECURITY	TPM	Infineon TPM2.0/1.2 (optional)
POWER	Type	ATX
	Connector	8-pin ATX 12V power 24-pin ATX power
	RTC Battery	CR2032 Coin Cell
OS SUPPORT		Windows 7 (/WES7) 32/64-bit Windows 8.1 (64-bit) Windows 10 IoT Enterprise 64-bit Note: 7th Gen Intel Core processors only support Win 10.
ENVIRONMENT	Temperature	Operating: 0 to 60°C Storage: -40 to 85°C
	Humidity	Operating: 5 to 90% RH Storage: 5 to 90% RH
	MTBF	365,364 hrs @ 25°C; 207,523 hrs @ 45°C; 131,395 hrs @ 60°C Calculation Model: Telcordia Issue 2, Method Case 3 Environment: GB, GC – Ground Benign, Controlled
MECHANICAL	Dimensions	microATX form factor 244mm (9.6") x 244mm (9.6")
CERTIFICATIONS		CE, FCC Class B, RoHS, UL

Features

• Watchdog Timer

The Watchdog Timer function allows your application to regularly “clear” the system at the set time interval. If the system hangs or fails to function, it will reset at the set time interval so that your system will continue to operate.

• DDR4

DDR4 delivers increased system bandwidth and improves performance. The advantages of DDR4 provide an extended battery life and improve the performance at a lower power than DDR3/DDR2.

• Graphics

The integrated Intel® HD graphics engine delivers an excellent blend of graphics performance and features to meet business needs. It provides excellent video and 3D graphics with outstanding graphics responsiveness. These enhancements deliver the performance and compatibility needed for today's and tomorrow's business applications. Supports 1 x VGA, 1 x LVDS, 1 x DVI-I (DVI-D signal) and 1 x DP++ interfaces for display outputs.

• PCI Express

PCI Express is a high bandwidth I/O infrastructure that possesses the ability to scale speeds by forming multiple lanes. The PCI Express architecture also supports high performance graphics infrastructure by enhancing the capability of a PCIe x16 Gen 3 at 16GB/s bandwidth.

• Serial ATA

Serial ATA is a storage interface that is compliant with SATA 1.0a specification. With speed of up to 6Gb/s (SATA 3.0), it improves hard drive performance faster than the standard parallel ATA whose data transfer rate is 100MB/s.

• Gigabit LAN

Two Intel® Gigabit LAN controllers (Intel® I211AT PCIe and Intel® I219V PCIe) support up to 1Gbps data transmission.

• Audio

The Realtek ALC888S-VD2-GR audio codec provides 5.1-channel High Definition audio output.

• Wake-On-PS/2

This function allows you to use the PS/2 keyboard or PS/2 mouse to power-on the system.

**Important:**

The 5V_standby power source of your power supply must support $\geq 720\text{mA}$.

• Wake-On-LAN

This feature allows the network to remotely wake up a Soft Power Down (Soft-Off) PC. It is supported via the onboard LAN port or via a PCI LAN card that uses the PCI PME (Power Management Event) signal. However, if your system is in the Suspend mode, you can power-on the system only through an IRQ or DMA interrupt.

**Important:**

The 5V_standby power source of your power supply must support $\geq 720\text{mA}$.

• Wake-On-USB

This function allows you to use a USB keyboard or USB mouse to wake up a system from the S3 (STR - Suspend To RAM) state.

**Important:**

If you are using the Wake-On-USB Keyboard/Mouse function for 2 USB ports, the 5V_standby power source of your power supply must support $\geq 1.5\text{A}$. For 3 or more USB ports, the 5V_standby power source of your power supply must support $\geq 2\text{A}$.

• RTC Timer

The RTC installed on the system board allows your system to automatically power-on on the set date and time.

• ACPI STR

The system board is designed to meet the ACPI (Advanced Configuration and Power Interface) specification. ACPI has energy saving features that enables PCs to implement Power Management and Plug-and-Play with operating systems that support OS Direct Power Management. ACPI when enabled in the Power Management Setup will allow you to use the Suspend to RAM function.

With the Suspend to RAM function enabled, you can power-off the system at once by pressing the power button or selecting “Standby” when you shut down Windows® without having to go through the sometimes tiresome process of closing files, applications and operating system. This is because the system is capable of storing all programs and data files during the entire operating session into RAM (Random Access Memory) when it powers-off. The operating session will resume exactly where you left off the next time you power-on the system.

- **Power Failure Recovery**

When power returns after an AC power failure, you may choose to either power-on the system manually or let the system power-on automatically.

- **USB**

The system board supports the new USB 3.0. It is capable of running at a maximum transmission speed of up to 5 Gbit/s (625 MB/s) and is faster than USB 2.0 (480 Mbit/s, or 60 MB/s) and USB 1.1 (12Mb/s). USB 3.0 reduces the time required for data transmission, reduces power consumption, and is backward compatible with USB 2.0. It is a marked improvement in device transfer speeds between your computer and a wide range of simultaneously accessible external Plug and Play peripherals.

Chapter 2 - Hardware Installation

Board Layout

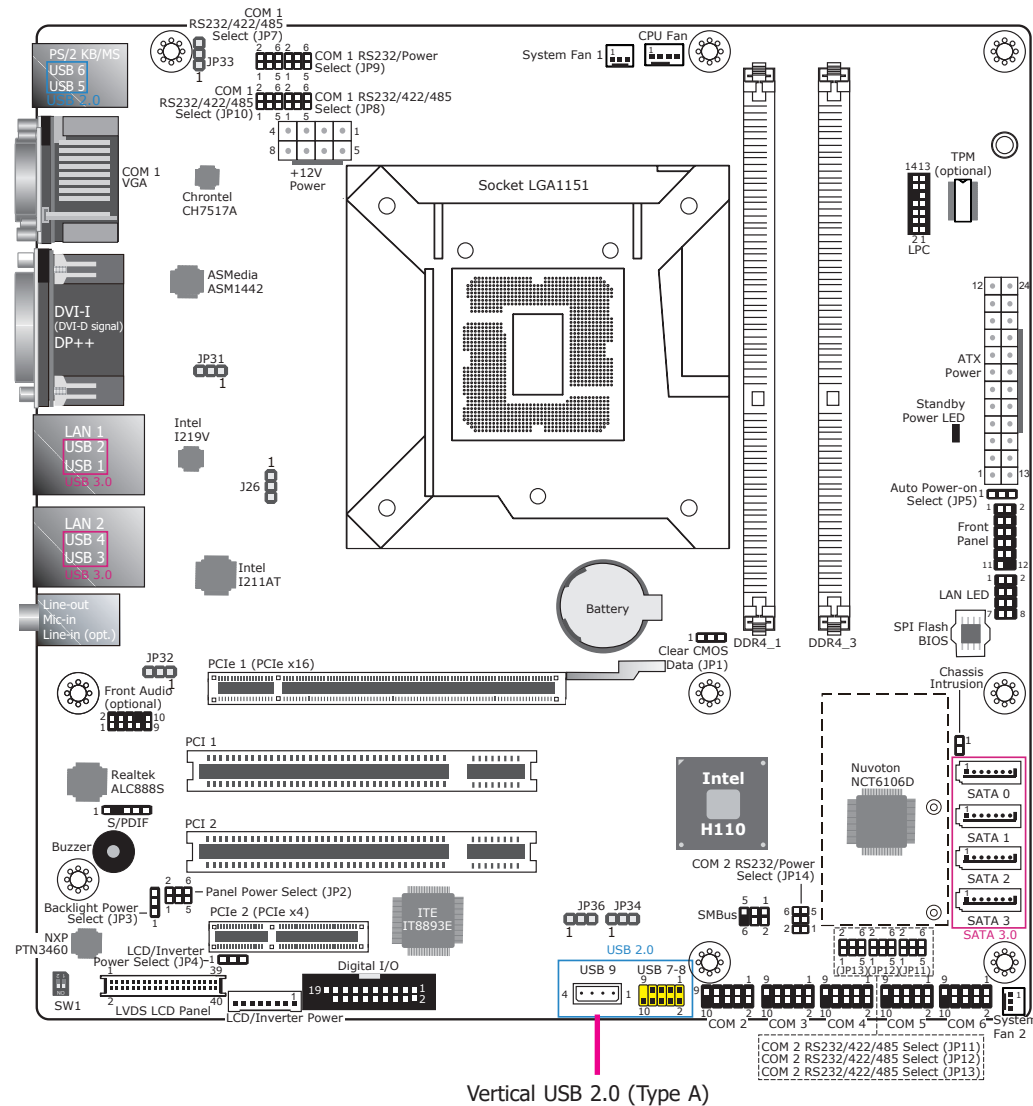

Important: Electrostatic discharge (ESD) can damage your board, processor, disk drives, add-in boards, and other components. Perform installation procedures at an ESD workstation only. If such a station is not available, you can provide some ESD protection by wearing an antistatic wrist strap and attaching it to a metal part of the system chassis. If a wrist strap is unavailable, establish and maintain contact with the system chassis throughout any procedures requiring ESD protection.

System Memory

Important: When the Standby Power LED lights red, it indicates that there is power on the system board. Power-off the PC then unplug the power cord prior to installing any devices. Failure to do so will cause severe damage to the motherboard and components.

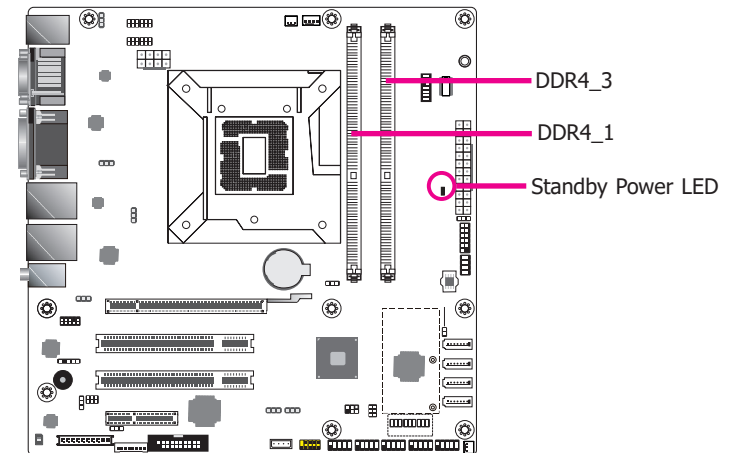

Features

- Two 288-pin DIMM up to 32GB
- Dual Channel DDR4 1866/2133MHz

The system board supports the following memory interface.

Single Channel (SC)

Data will be accessed in chunks of 64 bits (8B) from the memory channels.

Dual Channel (DC)

Data will be accessed in chunks of 128 bits from the memory channels. Dual channel provides better system performance because it doubles the data transfer rate.

Single Channel	DIMMs are on the same channel. DIMMs in a channel can be identical or completely different. However, we highly recommend using identical DIMMs. Not all slots need to be populated.
Dual Channel	DIMMs of the same memory configuration are on different channels.

Installing the DIMM Module



Note:

The system board used in the following illustrations may not resemble the actual board. These illustrations are for reference only.

1. Make sure the PC and all other peripheral devices connected to it has been powered down.
2. Disconnect all power cords and cables.
3. Locate the DIMM socket on the system board.
4. Push the "ejector tabs" which are at the ends of the socket to the side.



5. Note how the module is keyed to the socket.

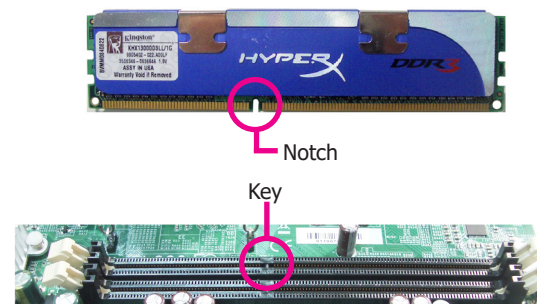

- Grasping the module by its edges, position the module above the socket with the “notch” in the module aligned with the “key” on the socket. The keying mechanism ensures the module can be plugged into the socket in only one way.

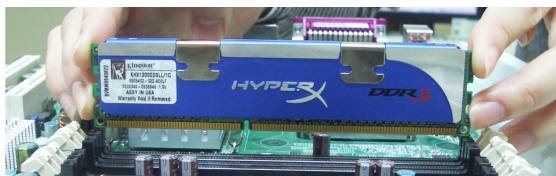

- Seat the module vertically, pressing it down firmly until it is completely seated in the socket.

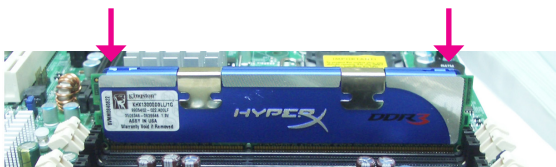

- The ejector tabs at the ends of the socket will automatically snap into the locked position to hold the module in place.



CPU

The system board is equipped with a surface mount LGA 1151 socket. This socket is exclusively designed for installing a LGA 1151 packaged Intel CPU.



Important:

- Before you proceed, make sure (1) the LGA 1151 socket comes with a protective cap, (2) the cap is not damaged and (3) the socket's contact pins are not bent. If the cap is missing or the cap and/or contact pins are damaged, contact your dealer immediately.
- Make sure to keep the protective cap. RMA requests will be accepted and processed only if the LGA 1151 socket comes with the protective cap.



Protective cap



Note:

The system board used in the following illustrations may not resemble the actual board. These illustrations are for reference only.

Installing the CPU

1. Make sure the PC and all other peripheral devices connected to it has been powered down.
2. Disconnect all power cords and cables.
3. Locate the LGA 1151 CPU socket on the system board.

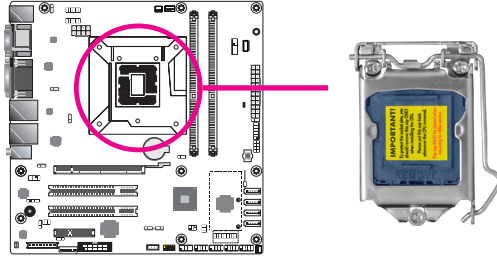

Important:

The CPU socket must not come in contact with anything other than the CPU. Avoid unnecessary exposure. Remove the protective cap only when you are about to install the CPU.

4. Unlock the socket by pushing the load lever down, moving it sideways until it is released from the retention tab; then lift the load lever up.

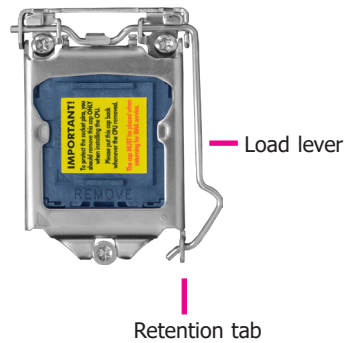

5. Lifting the load lever will at the same time lift the load plate.

Lift the load lever up to the angle shown on the photo.

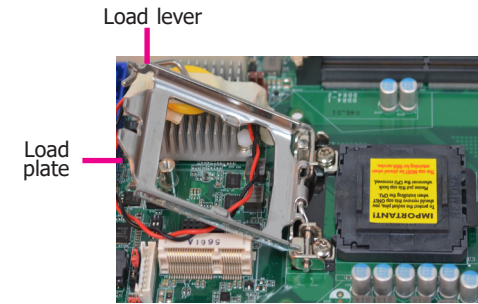

6. Remove the protective cap from the CPU socket. The cap is used to protect the CPU socket against dust and harmful particles. Remove the protective cap only when you are about to install the CPU.

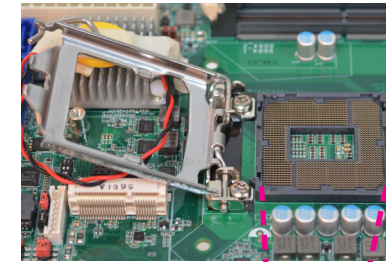

7. Insert the CPU into the socket. The gold triangular mark on the CPU must align with the corner of the CPU socket shown on the photo.

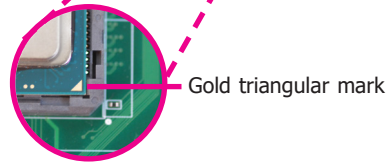
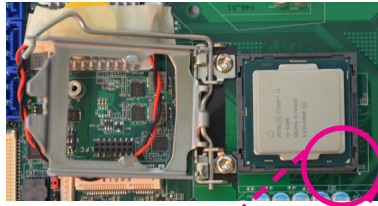

Alignment key

The CPU's notch will at the same time fit into the socket's alignment key.

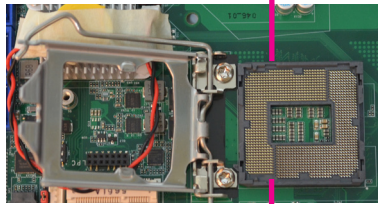

Alignment key



Important:

The CPU will fit in only one orientation and can easily be inserted without exerting any force.

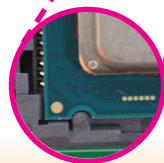
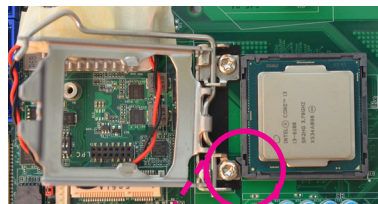

8. Close the load plate then push the load lever down.

While closing the load plate, make sure the front edge of the load plate slides under the retention knob.



9. Hook the load lever under the retention tab.

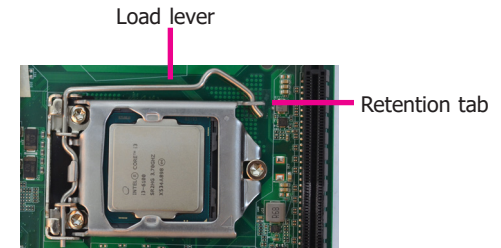

Installing the Fan and Heat Sink

The CPU must be kept cool by using a CPU fan with heat sink. Without sufficient air circulation across the CPU and heat sink, the CPU will overheat damaging both the CPU and system board.



Note:

A boxed Intel® processor already includes the CPU fan and heat sink assembly. If your CPU was purchased separately, make sure to only use Intel®-certified fan and heat sink.

1. Before you install the fan / heat sink, you must apply a thermal paste onto the top of the CPU. The thermal paste is usually supplied when you purchase the fan / heat sink assembly. Do not spread the paste all over the surface. When you later place the heat sink on top of the CPU, the compound will disperse evenly.

Some heat sinks come with a patch of pre-applied thermal paste. Do not apply thermal paste if the fan / heat sink already has a patch of thermal paste on its underside. Peel the strip that covers the paste before you place the fan / heat sink on top of the CPU.

2. Place the heat sink on top of the CPU. The 4 screw around the heat sink, which are used to secure the heat sink onto the system board, must match the 4 mounting holes around the socket.

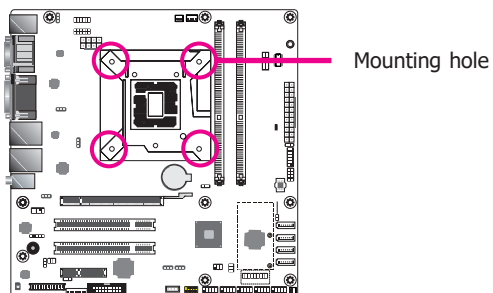

3. Orient the heat sink such that the CPU fan's cable is nearest the CPU fan connector.

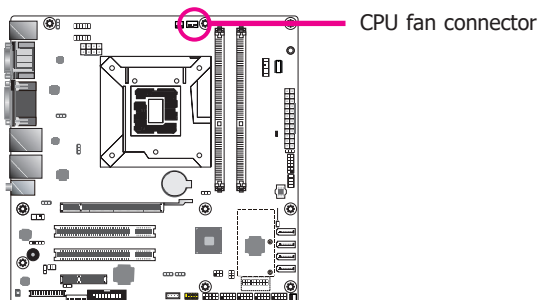

4. Rotate each screw that are diagonally across the heat sink. Perform the same procedure for the other screws.

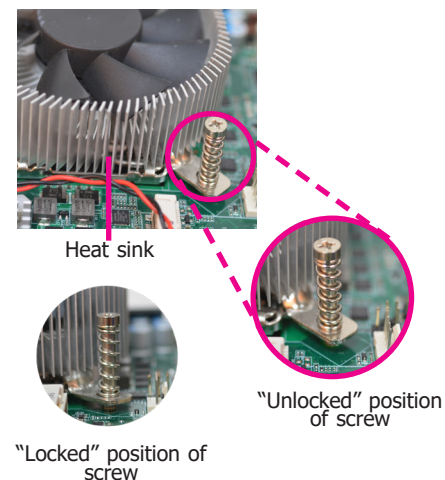

5. Connect the CPU fan's cable to the CPU fan connector on the system board.

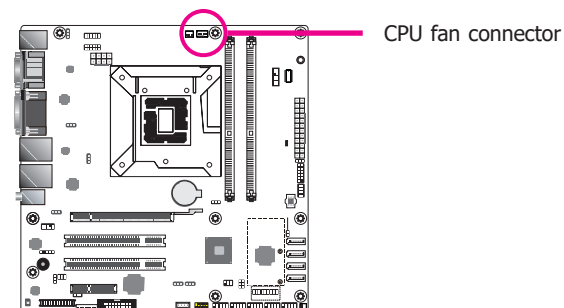

Jumper Settings

Clear CMOS Data

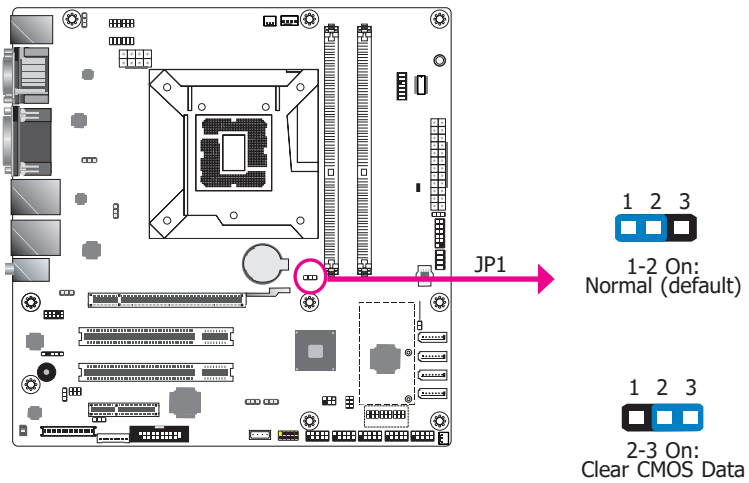

If you encounter the followings,

- a) CMOS data becomes corrupted.
- b) You forgot the supervisor or user password.

you can reconfigure the system with the default values stored in the ROM BIOS.

To load the default values stored in the ROM BIOS, please follow the steps below.

1. Power-off the system and unplug the power cord.
2. Set JP1 pins 2 and 3 to On. Wait for a few seconds and set JP1 back to its default setting, pins 1 and 2 On.
3. Now plug the power cord and power-on the system.

COM1/COM2 RS232/422/485 Select

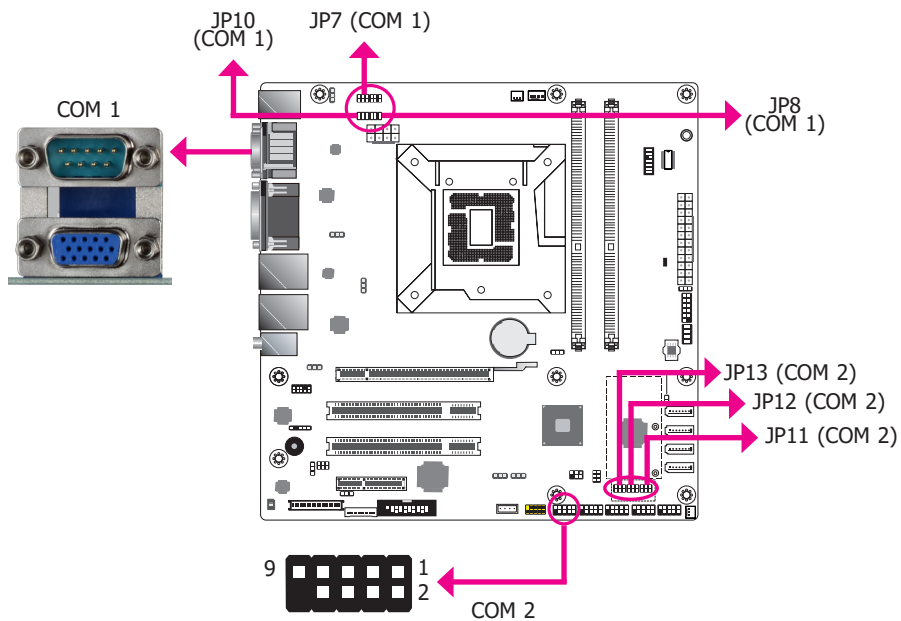

JP7/JP8/JP10 (for COM 1) and JP11/JP12/JP13 (for COM 2) are used to configure the COM ports to RS232, RS422 (Full Duplex) or RS485. When COM 1 RS232/422/485 is selected, JP8 and JP10 must be set in accordance to JP7. When COM 2 RS232/422/485 is selected, JP12 and JP13 must be set in accordance to JP11. The pin functions of the COM ports will vary according to the jumpers' setting.

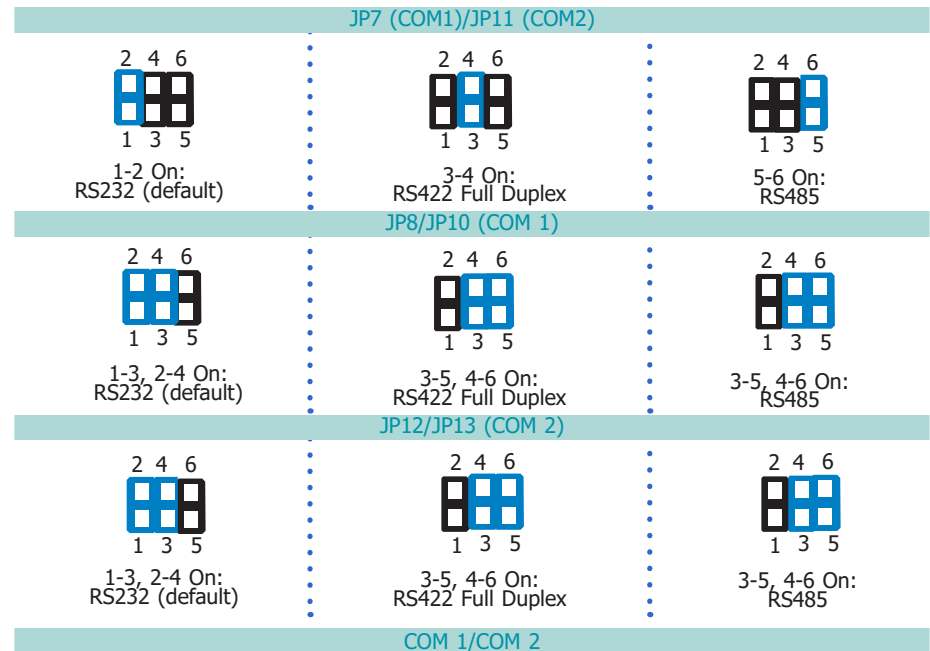

Pin	RS232	RS422 Full Duplex	RS485
1	DCD-	RXD+	DATA+
2	RD	RXD-	DATA-
3	TD	TXD+	N.C.
4	DTR-	TXD-	N.C.
5	GND	GND	GND
6	DSR-	N.C.	N.C.
7	RTS-	N.C.	N.C.
8	CTS-	N.C.	N.C.
9	RI-	N.C.	N.C.

COM1/COM2 RS232/Power Select

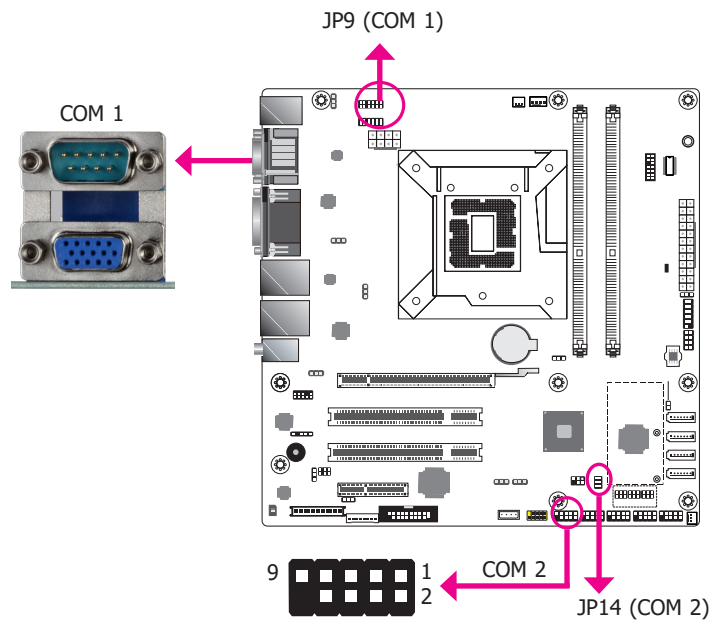

JP9 (for COM 1) and JP14 (for COM 2) are used to configure Serial COM ports to pure RS232 or RS232 with power. The pin functions of COM 1 and COM 2 will vary according to JP9's and JP14's setting respectively.

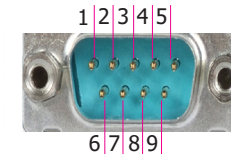
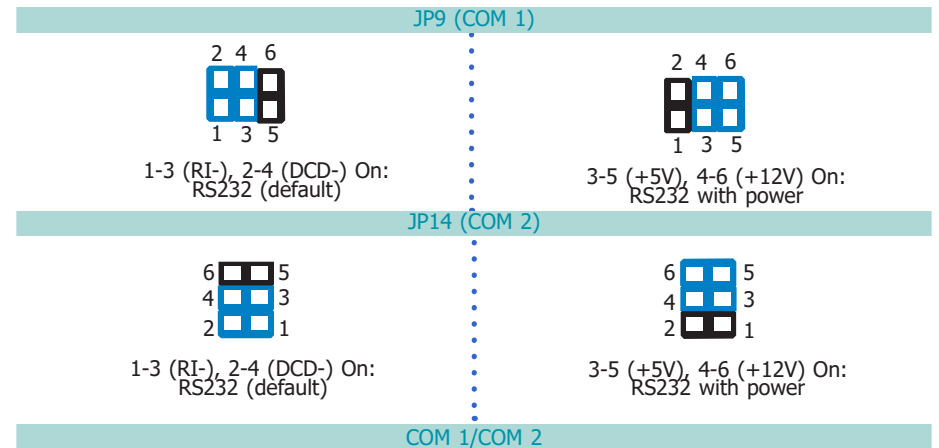

Pin	RS232	RS232 with power
1	DCD-	+12V
2	RD	RD
3	TD	TD
4	DTR-	DTR-
5	GND	GND
6	DSR-	DSR-
7	RTS-	RTS-
8	CTS-	CTS-
9	RI-	+5V

Panel Power Select

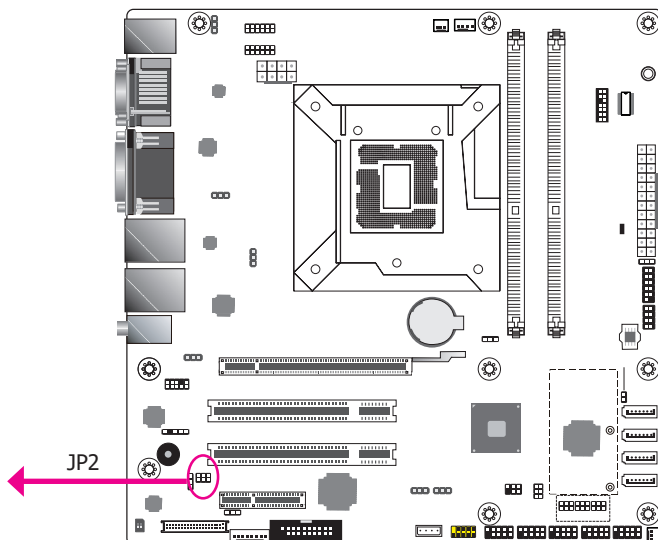
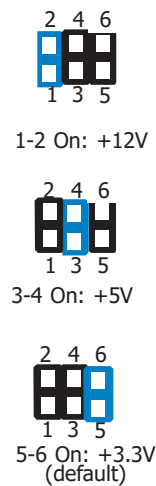

JP2 is used to select the power supplied with the LCD panel.



Important:

Before powering-on the system, make sure that the power settings of JP2 match the LCD panel's specification. Selecting the incorrect voltage will seriously damage the LCD panel.

LCD/Inverter Power Select

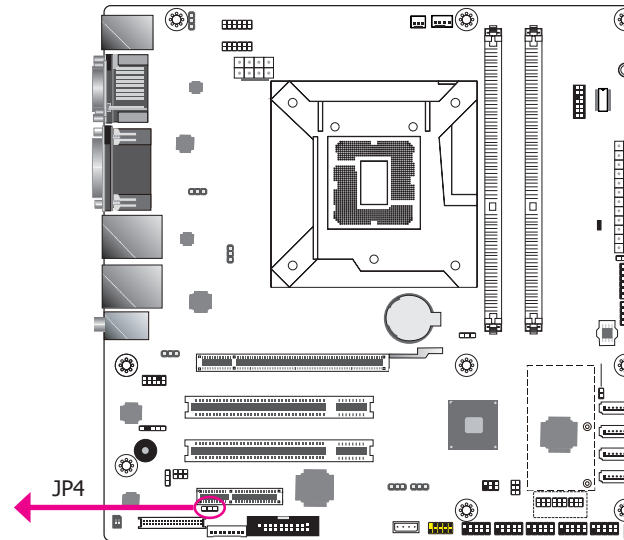
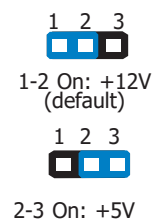

JP4 is used to select the power level of the LCD/inverter power connector.

Backlight Power Select

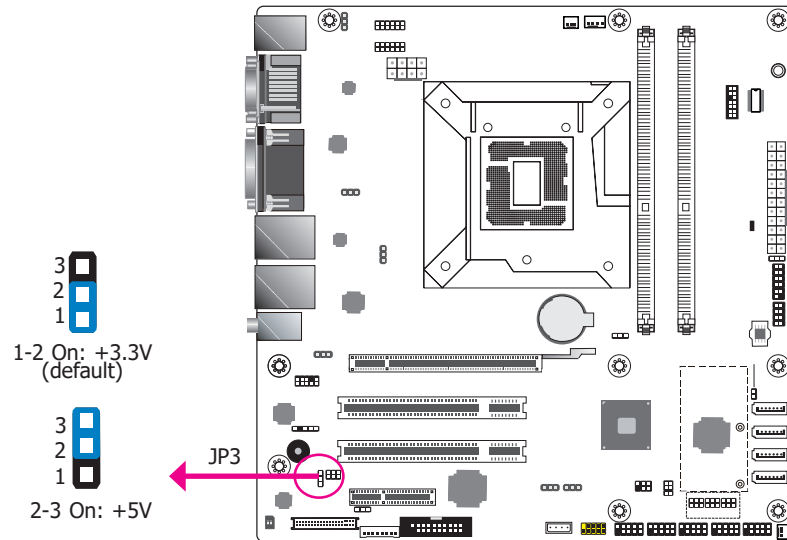

JP3 is used to select the power level of backlight brightness control: +3.3V (default) or +5V.



Important:

Before powering-on the system, make sure that the power settings of JP3 match the power specification of backlight control. Selecting the incorrect voltage will seriously damage the backlight.

USB Power Select

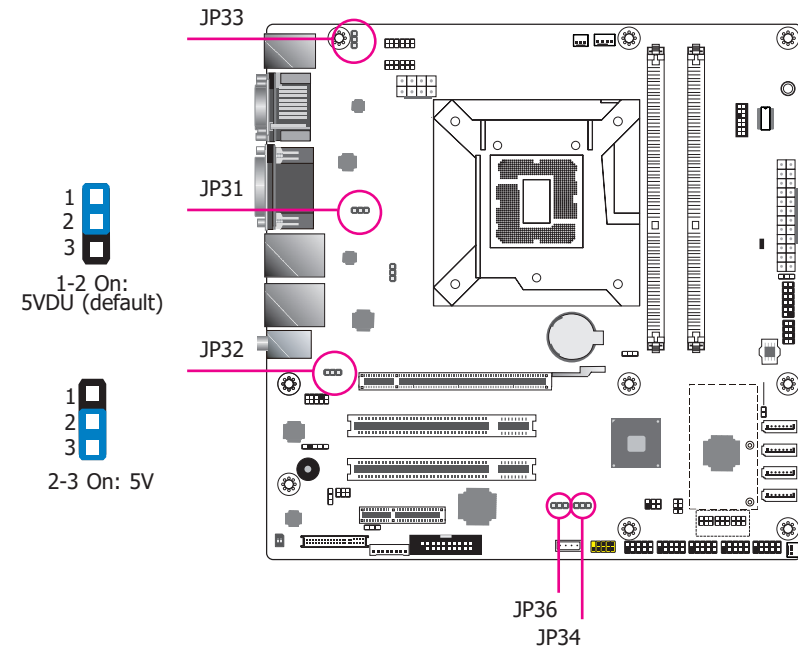

The power of the USB connectors' voltage buses can be configured to either 5VDU or 5V. The jumpers, i.e. JP31, JP32, JP33, JP34, and JP36 are located as illustrated above and correspond to each USB port number as listed below.

JP number	USB Port
JP31	USB 1/2 (USB 3.0)
JP32	USB 3/4 (USB 3.0)
JP33	USB 5/6 (USB 2.0)
JP34	USB 7/8/9/10 (USB 2.0)
JP36	USB 5/6 (USB 3.0)

Rear Panel I/O Ports

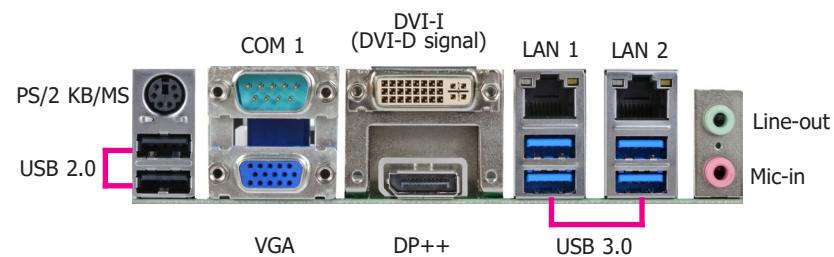

The rear panel I/O ports consist of the following:

- 1 PS/2 Keyboard/Mouse port
- 2 USB 2.0 ports
- 1 Serial COM port
- 1 VGA port
- 1 DVI-I (DVI-D signal) port
- 1 DP++ port
- 2 RJ45 LAN ports
- 4 USB 3.0 ports
- 1 Line-in jack (optional)
- 1 Line-out jack
- 1 Mic-in jack

PS/2 Keyboard/Mouse Port

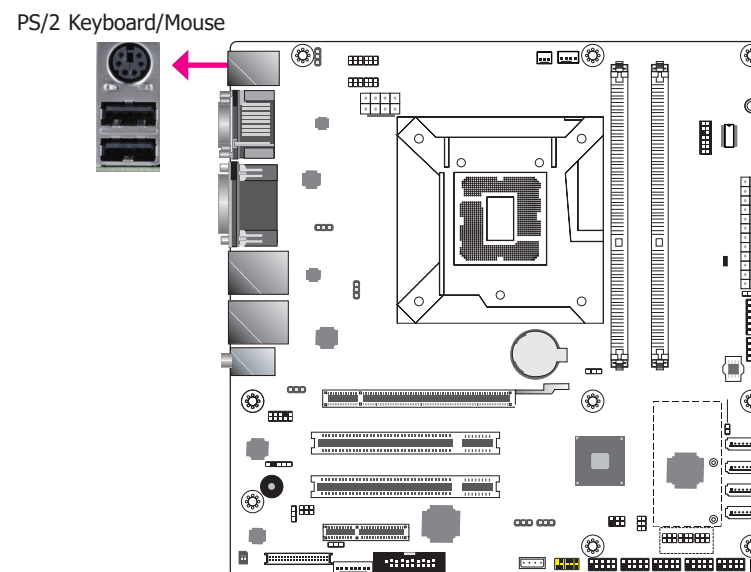

This rear I/O port is used to connect a PS/2 keyboard/mouse. The PS/2 mouse port uses IRQ12.

Wake-On-PS/2 Keyboard/Mouse

The Wake-On-PS/2 Keyboard/Mouse function allows you to use the PS/2 keyboard or PS/2 mouse to power-on the system. To use this function:

• BIOS Setting

Configure the wake-up function of PS/2 keyboard/mouse in the Advanced menu ("ACPI Configuration" submenu) of the BIOS. Refer to the chapter 3 for more information.



Important:

The +5V_standby power source of your power supply must support $\geq 720\text{mA}$.

COM (Serial) Ports

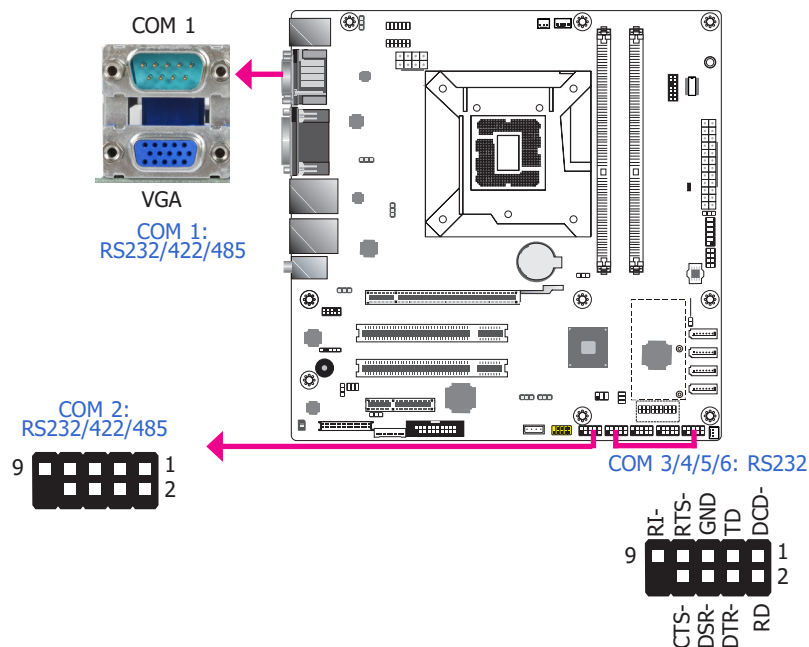

Pin	Assignment	Pin	Assignment
1	MDCD1-/ RS422_RX+ / RS485_D+	2	MSIN1-/ RS422_RX- / RS485_D-
3	MSO1-/RS422_TX+	4	MDTR1-/RS422_TX-
5	GND	6	MDSR1-
7	MRTS1-	8	MCTS1-
9	MRI1-	10	--

Graphics Interfaces

The display ports consist of the following:

- 1 VGA port
- 1 DVI-I (DVI-D signal) port
- 1 DP++ port

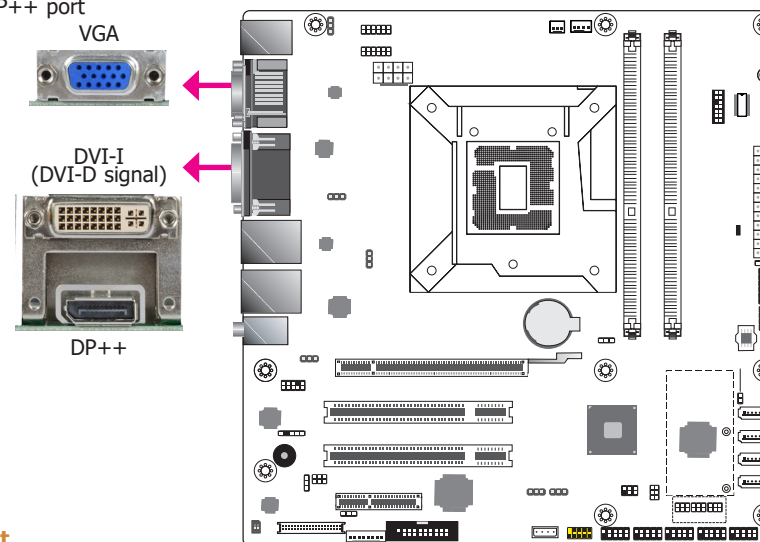

VGA Port

The VGA port is used for connecting a VGA monitor. Connect the monitor's 15-pin D-shell cable connector to the VGA port. After you plug the monitor's cable connector into the VGA port, gently tighten the cable screws to hold the connector in place.

DVI-I (DVI-D Signal) Port

The DVI-I port is used to connect an LCD monitor. This port supports DVI-D signal only. Connect the display device's cable connector to the DVI-I port. After plugging the cable connector into the port, gently tighten the cable screws to hold the connector in place.

DP++ Port

The DP++ port which carries both digital audio and video signals is used to connect a LCD monitor or digital TV that has the DP++ port.

BIOS Setting

Configure the display devices in the advanced menu ("Video Configuration" submenu) of the BIOS. Refer to the chapter 3 for more information.

Driver Installation

Install the graphics driver. Refer to the chapter 4 for more information.

RJ45 LAN Ports

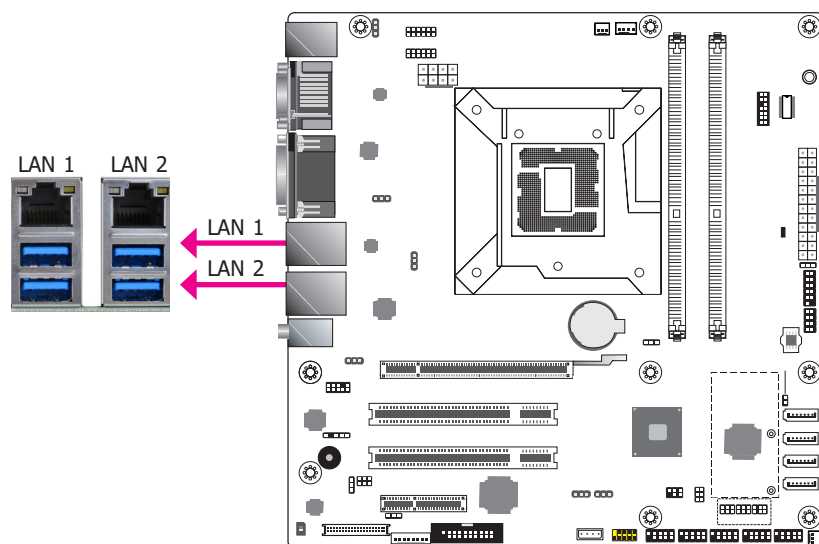

Features

- Intel® I211AT PCI Express Gigabit Ethernet controller
- Intel® I219V Gigabit Ethernet Phy

The LAN ports allow the system board to connect to a local area network by means of a network hub.

BIOS Setting

Configure the onboard LAN ports in the Advanced menu ("ACPI Configuration" submenu) of the BIOS. Refer to the chapter 3 for more information.

Driver Installation

Install the LAN drivers. Refer to the chapter 4 for more information.

USB Ports

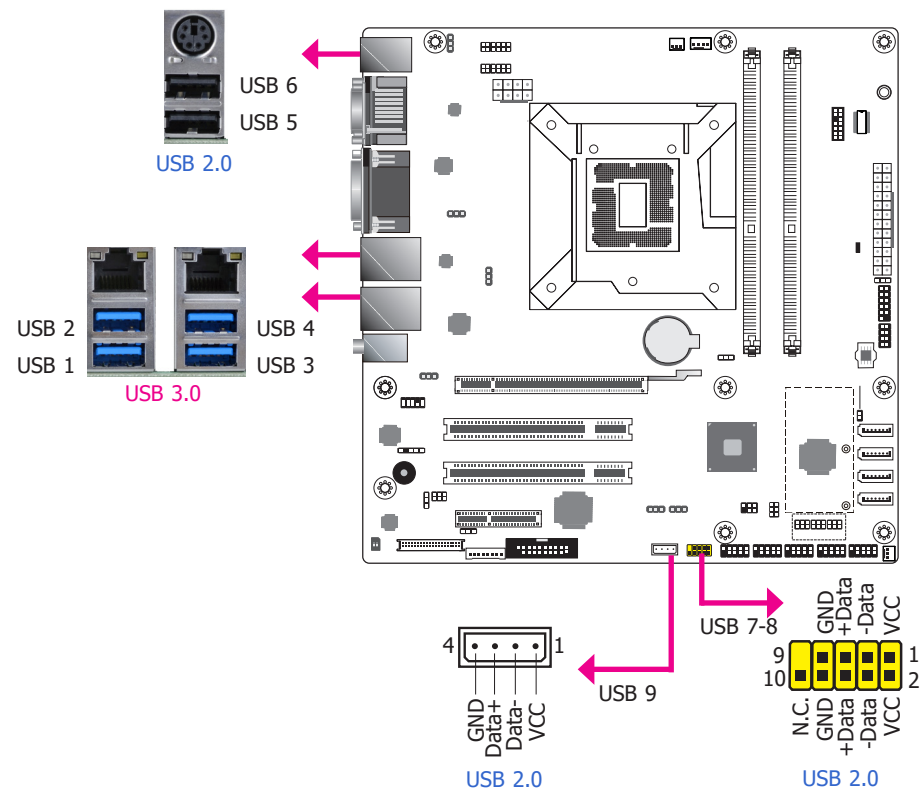

The USB device allows data exchange between your computer and a wide range of simultaneously accessible external Plug and Play peripherals.

The system board is equipped with 2 onboard USB 2.0 ports (USB 5-6) and 4 onboard USB 3.0 ports (USB 1-2/3-4). The 10-pin connector allows you to connect 2 additional USB 2.0 ports (USB 7-8). The vertical USB (type A) allows you to connect 1 additional USB 2.0 port (USB 9). The additional USB ports may be mounted on a card-edge bracket. Install the card-edge bracket to an available slot at the rear of the system chassis and then insert the USB port cables to a connector.

BIOS Setting

Configure these USB devices in the Advanced menu ("USB Configuration" submenu) of the BIOS. Refer to the chapter 3 for more information.

Driver Installation

You may need to install the proper drivers in your system operation to use the USB device. Refer to your operating system's manual or documentation for more information.

Wake-On-USB Keyboard/Mouse

The Wake-On-USB Keyboard/Mouse function allows you to use a USB keyboard or USB mouse to wake up a system from the S3 (STR - Suspend To RAM) state.



Important:

If you are using the Wake-On-USB Keyboard/Mouse function for 2 USB ports, the +5V_standby power source of your power supply must support $\geq 1.5A$. For 3 or more USB ports, the +5V_standby power source of your power supply must support $\geq 2A$.

Audio

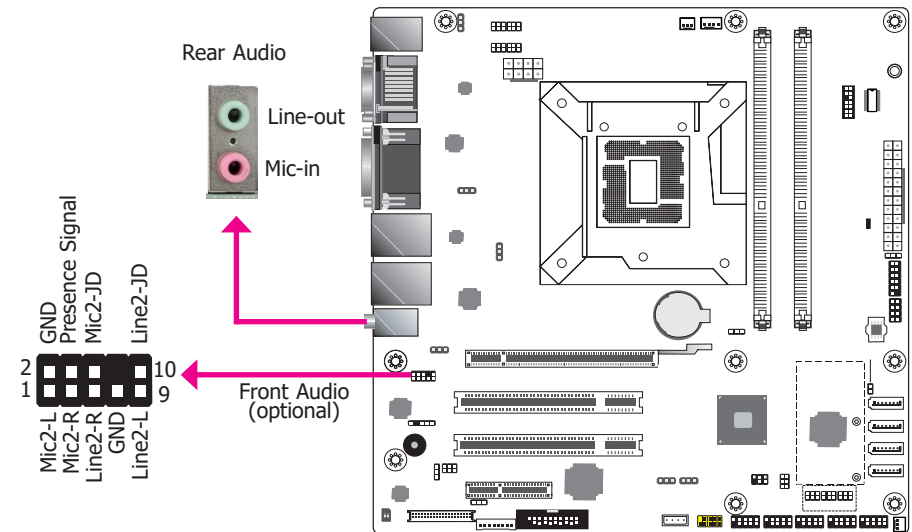

Rear Audio

The system board is equipped with 2 audio jacks (Line-out and Mic-in). Line-in jack is available upon request. A jack is a one-hole connecting interface for inserting a plug.

- Line-in Jack (Light Blue) (optional)
This jack is used to connect any audio devices such as Hi-fi set, CD player, tape player, AM/FM radio tuner, synthesizer, etc.
- Line-out Jack (Lime)
This jack is used to connect a headphone or external speakers.
- Mic-in Jack (Pink)
This jack is used to connect an external microphone.

Front Audio (optional)

The front audio connector allows you to connect to the second line-out and mic-in jacks that are at the front panel of your system.

BIOS Setting

Configure these Audio devices in the Advanced menu ("Audio Configuration" submenu) of the BIOS. Refer to the chapter 3 for more information.

Driver Installation

Install the audio driver. Refer to the chapter 4 for more information.

I/O Connectors

SATA (Serial ATA) Connectors

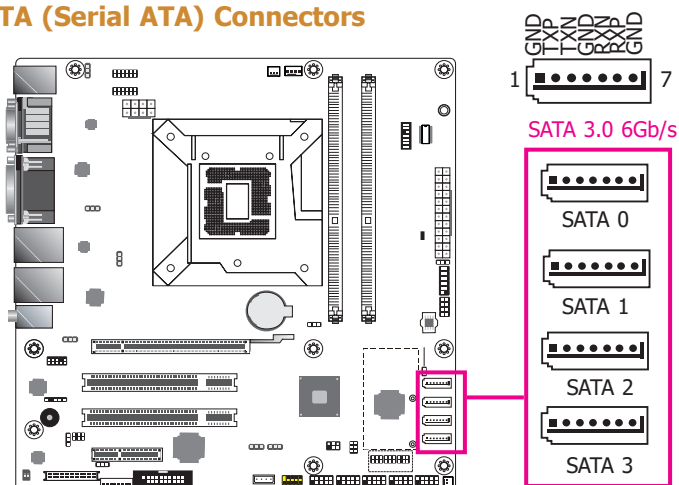

Features

- 4 Serial ATA ports
- 4 SATA 3.0 ports with data transfer rate up to 6Gb/s (SATA 0, SATA 1, SATA 2, SATA 3)
- Integrated Advanced Host Controller Interface (AHCI) controller

The Serial ATA connectors are used to connect Serial ATA devices. Connect one end of the Serial ATA data cable to a SATA connector and the other end to your Serial ATA device.

BIOS Setting

Configure the Serial ATA drives in the Advanced menu ("SATA Configuration" submenu) of the BIOS. Refer to the chapter 3 for more information.



Note:

Some 3rd party SATA Gen 2 speed device controllers used on the system board paired with the Intel® 8 series chipset are intermittently detected. Before using SSD devices or mSATA SSD devices, please check whether the device and the cable which are used on the system board conform to Intel's official regulations.

Digital I/O Connector

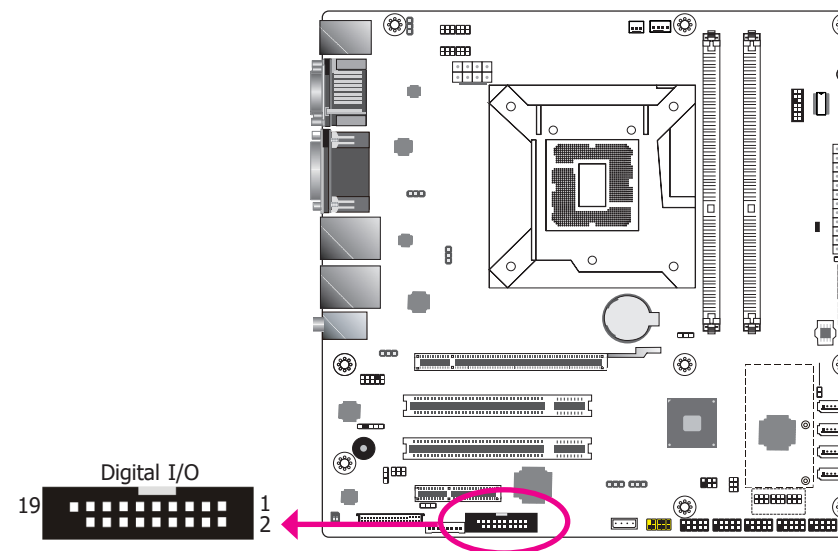

The 8-bit Digital I/O connector provides powering-on function to external devices that are connected to these connectors. The pin functions of the 8-bit digital I/O connector are listed below.

Digital I/O Connector

Pin	Pin Assignment	Pin	Pin Assignment
1	GND	2	+12V
3	DIO7	4	+12V
5	DIO6	6	GND
7	DIO5	8	+5V
9	DIO4	10	+5V
11	DIO3	12	GND
13	DIO2	14	+5V _{DU}
15	DIO1	16	+5V _{DU}
17	DIO0	18	GND
19	GND		

Cooling Fan Connectors

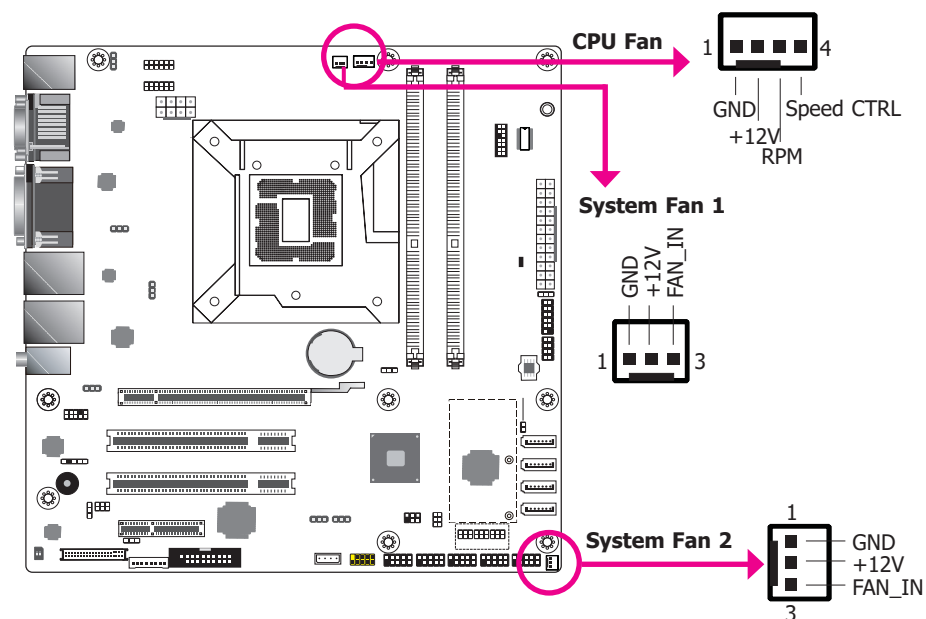

These fan connectors are used to connect cooling fans. The cooling fans will provide adequate airflow throughout the chassis to prevent overheating the CPU and system board components.

BIOS Setting

The Advanced menu ("SIO NUVOTON6106D" submenu) of the BIOS will display the current speed of the cooling fans. Refer to chapter 3 for more information.

Power Connectors

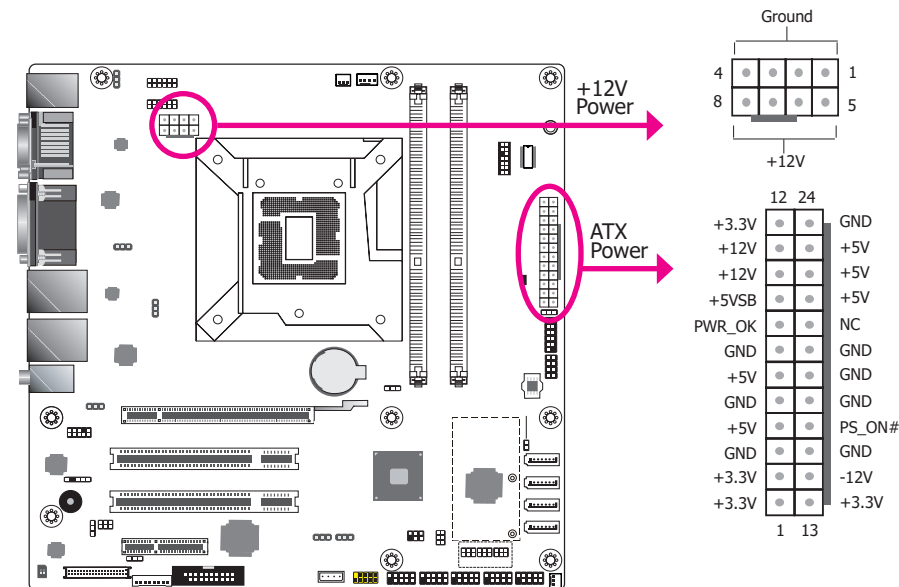

Use a power supply that complies with the ATX12V Power Supply Design Guide Version 1.1. An ATX12V power supply unit has a standard 24-pin ATX main power connector that must be inserted into the 24-pin connector. The 8-pin +12V power connector enables the delivery of more +12VDC current to the processor's Voltage Regulator Module (VRM).

The power connectors from the power supply unit are designed to fit the 24-pin and 8-pin connectors in only one orientation. Make sure to find the proper orientation before plugging the connectors.

The system board requires a minimum of 300 Watt power supply to operate. Your system configuration (CPU power, amount of memory, add-in cards, peripherals, etc.) may exceed the minimum power requirement. To ensure that adequate power is provided, we strongly recommend that you use a minimum of 400 Watt (or greater) power supply.



Important:

Insufficient power supplied to the system may result in instability or the add-in boards and peripherals not functioning properly. Calculating the system's approximate power usage is important to ensure that the power supply meets the system's consumption requirements.

LVDS LCD Panel Connector

LCD/Inverter Power Connector

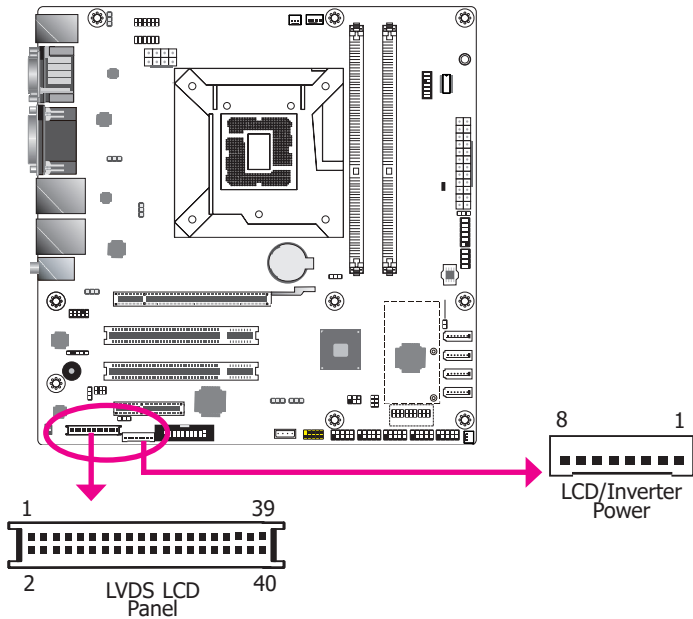

The system board allows you to connect a LCD Display Panel by means of the LVDS LCD panel connector and the LCD/Inverter power connector. These connectors transmit video signals and power from the system board to the LCD Display Panel.

Refer to the right side for the pin functions of these connectors.

BIOS Setting

Configure the LCD panel in the Advanced menu ("Video Configuration" sub-menu) of the BIOS. Refer to the chapter 3 for more information.

LVDS LCD Panel Connector

Pin	Function	Pin	Function
1	GND	2	GND
3	LVDS_Out3+	4	LVDS_Out7+
5	LVDS_Out3-	6	LVDS_Out7-
7	GND	8	GND
9	LVDS_Out2+	10	LVDS_Out6+
11	LVDS_Out2-	12	LVDS_Out6-
13	GND	14	GND
15	LVDS_Out1+	16	LVDS_Out5+
17	LVDS_Out1-	18	LVDS_Out5-
19	GND	20	GND
21	LVDS_Out0+	22	LVDS_Out4+
23	LVDS_Out0-	24	LVDS_Out4-
25	GND	26	GND
27	LVDS_CLK1+	28	LVDS_CLK2+
29	LVDS_CLK1-	30	LVDS_CLK2-
31	GND	32	GND
33	DDC_CLK	34	NC
35	DDC_DATA	36	+3.3V
37	Panel Power	38	Panel Power
39	Panel Power	40	Panel Power

LCD/Inverter Power Connector

Pin	Function
1	GND
2	GND
3	Panel Inverter Brightness Voltage Control
4	Panel Power
5	+3.3V
6	Panel Backlight On/Off Control
7	+12V (default) / 5V
8	+12V (default) / 5V



Note:

DFI board's LVDS connector: Hirose DF13-40DP-1.25V(91)/40P/1.25mm; cable side connector: Hirose DF13-40DS-1.25C.

Chassis Intrusion Connector

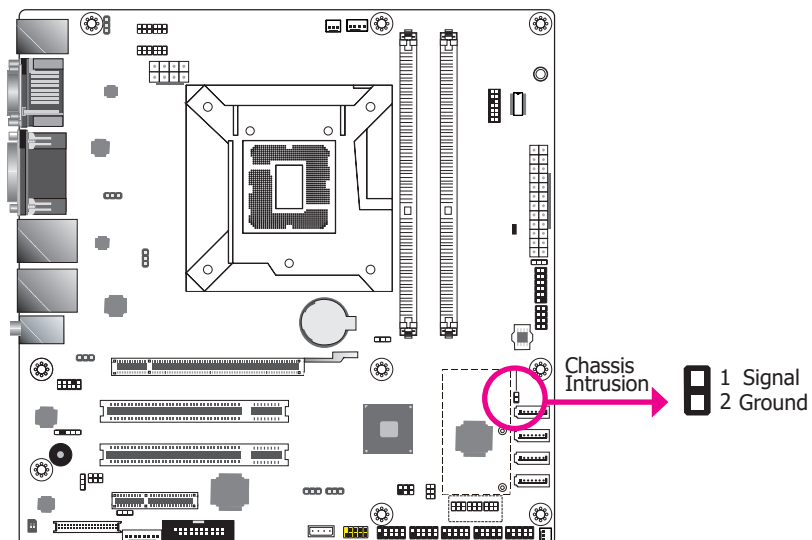

The board supports the chassis intrusion detection function. Connect the chassis intrusion sensor cable from the chassis to this connector. When the system's power is on and a chassis intrusion occurred, an alarm will sound. When the system's power is off and a chassis intrusion occurred, the alarm will sound only when the system restarts.

BIOS Setting

Configure the chassis intrusion detection function in the Advanced menu ("SIO NUVO-TON6106D" submenu) of the BIOS. Refer to the chapter 3 for more information.

Front Panel Connector

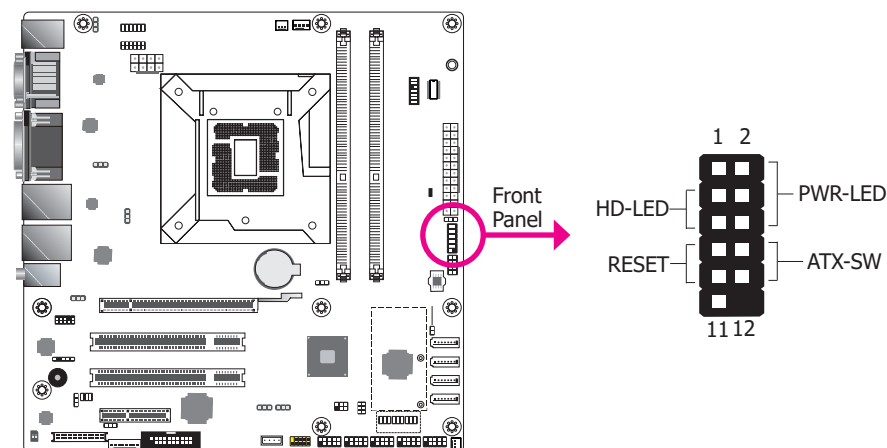

HD-LED - Hard Drive LED

This LED will light when the hard drive is being accessed.

RESET - Reset Switch

This switch allows you to reboot without having to power off the system.

PWR-LED - Power/Standby LED

When the system's power is on, this LED will light. When the system is in the S1 (POS - Power On Suspend) state, it will blink every second. When the system is in the S3 (STR - Suspend To RAM) state, it will blink every 4 seconds.

ATX-SW - ATX Power Switch

This switch is used to power on or off the system.

	Pin	Pin Assignment		Pin	Pin Assignment
HD-LED	3	HDD Power	PWR-LED	2	LED Power
	5	Signal		4	LED Power
	7	Ground		6	Signal
RESET	9	RST Signal	ATX-SW	8	Ground
	11	N.C.		10	Signal

Standby Power LED

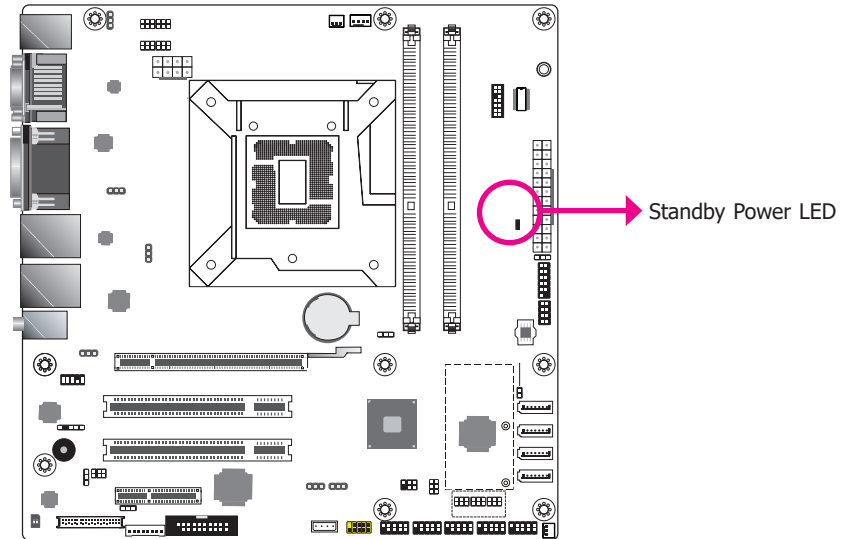

This LED will lit red when the system is in the standby mode. It indicates that there is power on the system board. Power-off the PC and then unplug the power cord prior to installing any devices. Failure to do so will cause severe damage to the motherboard and components.

S/PDIF Connector

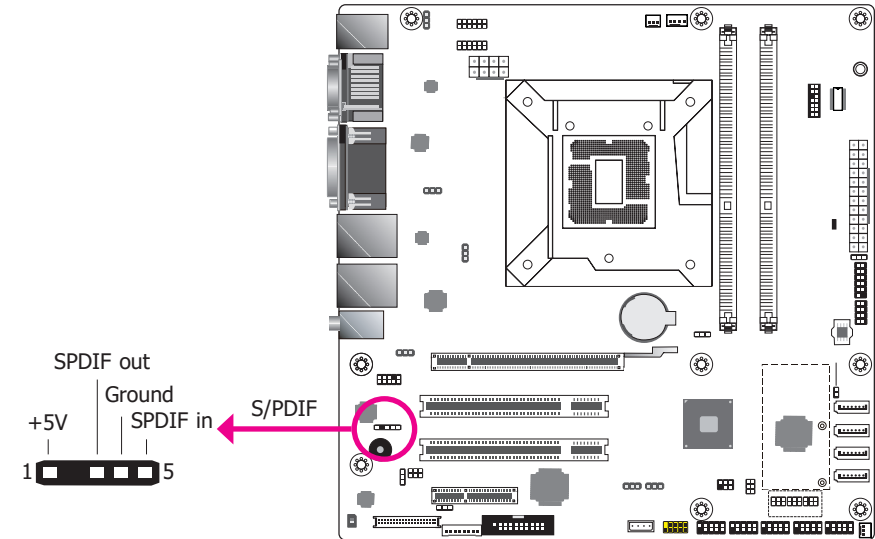

The S/PDIF connector is used to connect an external S/PDIF port. Your S/PDIF port may be mounted on a card-edge bracket. Install the card-edge bracket to an available slot at the rear of the system chassis then connect the audio cable to the S/PDIF connector. Make sure pin 1 of the audio cable is aligned with pin 1 of the S/PDIF connector.

SMBus Connector

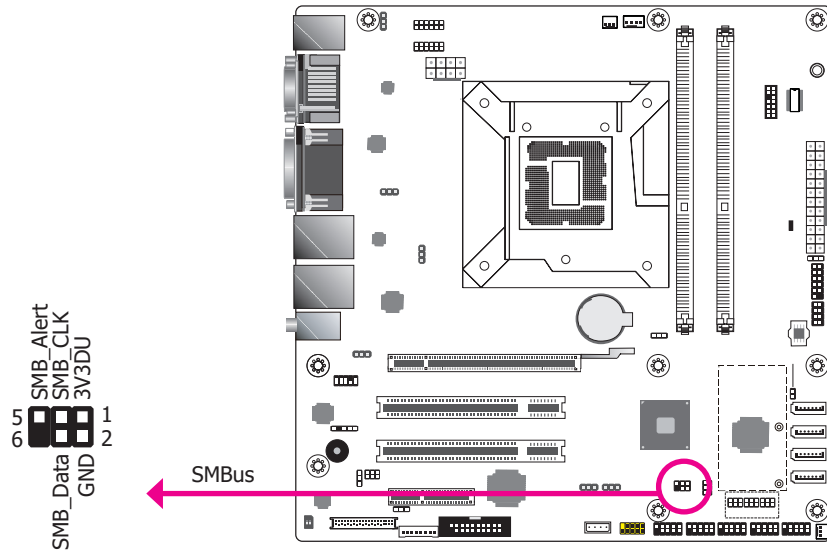

The SMBus (System Management Bus) connector is used to connect SMBus devices. It is a multiple device bus that allows multiple chips to connect to the same bus and enable each one to act as a master by initiating data transfer.

LAN LED Connector

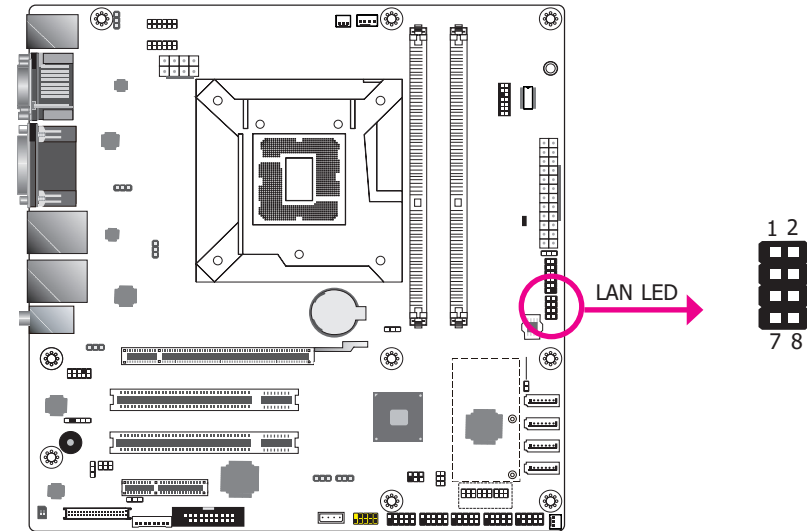

The LAN LED connector is used to detect the connection state of RJ45 LAN ports when the connection is made to an active network via a cable. The pin functions of the LAN LED connector are listed below.

Pin	Pin Assignment	Pin	Pin Assignment
1	GBE_LED_1000-	2	GBE_LED_100-
3	GBE_LED_LINK_ACT-	4	3V3DU
5	LINK_1000_2	6	LINK_100_2
7	LINK_ACTIVITY_2	8	3V3DU

LPC Connector

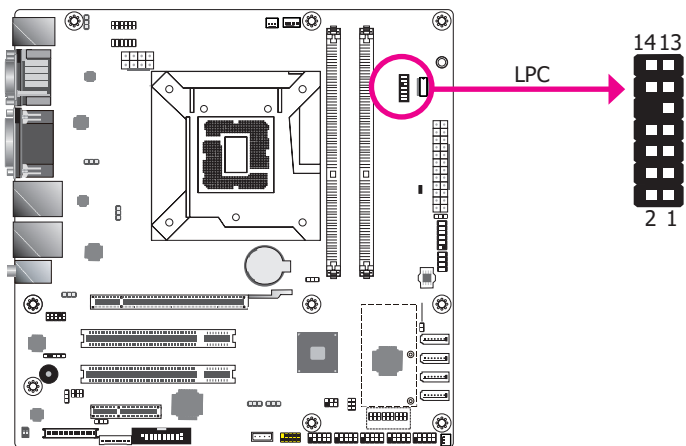

The Low Pin Count Interface was defined by Intel® Corporation to facilitate the industry's transition towards legacy free systems. It allows the integration of low-bandwidth legacy I/O components within the system, which are typically provided by a Super I/O controller. Furthermore, it can be used to interface firmware hubs, Trusted Platform Module (TPM) devices and embedded controller solutions. Data transfer on the LPC bus is implemented over a 4 bit serialized data interface, which uses a 48MHz LPC bus clock. For more information about LPC bus refer to the Intel® Low Pin Count Interface Specification Revision 1.1'. The table below indicates the pin functions of the LPC connector.

Pin	Pin Assignment	Pin	Pin Assignment
1	L_CLK	2	L_AD1
3	L_RST#	4	L_AD0
5	L_FRAME#	6	3V3
7	L_AD3	8	GND
9	L_AD2	10	---
11	INT_SERIRQ	12	GND
13	5VSB	14	5V

Connecting the EXT-RS232/RS485 Card to the Motherboard

With DFI's proprietary technology, SD330-H110 supports two extension modules for additional four COM ports. The EXT-RS232/RS485 card is connected to SD330-H110 via the LPC connector. The illustrations below guide you how to connect the extension module to the motherboard.

Note:
The system board used in the following illustrations may not resemble the actual one. These illustrations are for reference only.

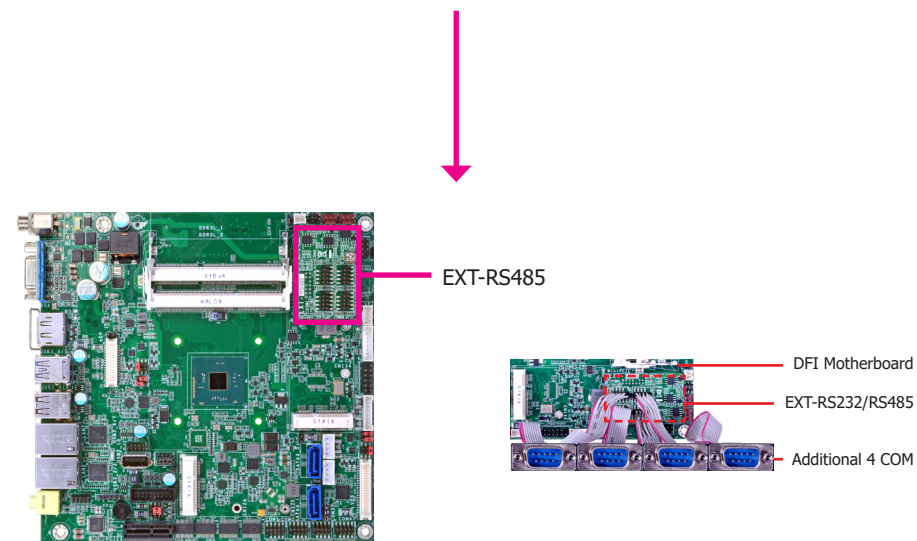
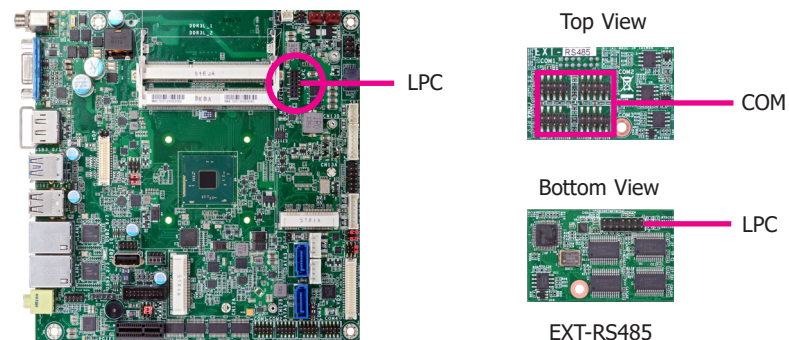

Expansion Slots

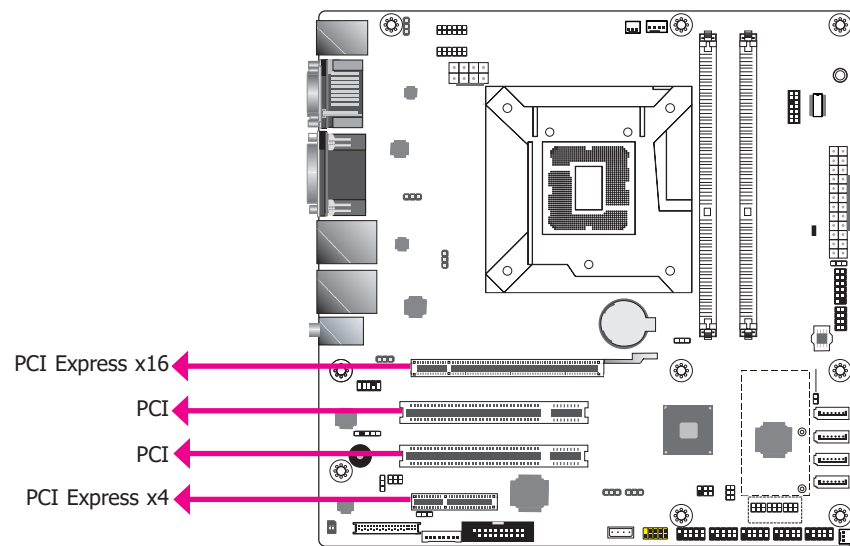

PCI Express x16 Slot

Install PCI Express x16 graphics card, that comply to the PCI Express specifications, into the PCI Express x16 slot. To install a graphics card into the x16 slot, align the graphics card above the slot then press it down firmly until it is completely seated in the slot. The retaining clip of the slot will automatically hold the graphics card in place.

PCI Slot

The PCI slot supports expansion cards that comply with PCI specifications. You can install a PCI expansion card or a customized riser card designed for only 2 PCI slots expansion (for low profile PCI card only) into the PCI slot.

PCI Express x4 Slot

Install PCI Express cards such as network cards or other cards that comply to the PCI Express specifications into the PCI Express x4 slot.

Battery

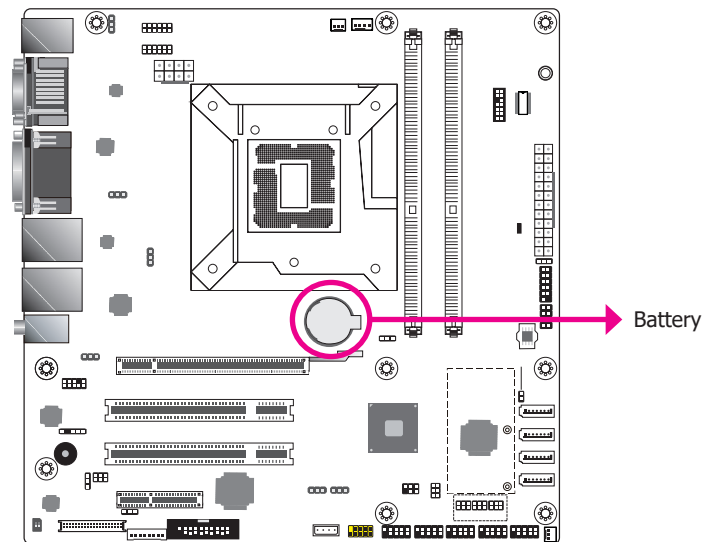

The lithium ion battery powers the real-time clock and CMOS memory. It is an auxiliary source of power when the main power is shut off.

Safety Measures

- Danger of explosion if battery incorrectly replaced.
- Replace only with the same or equivalent type recommended by the manufacturer.
- Dispose of used batteries according to local ordinance.

Chapter 3 - BIOS Setup

Overview

The BIOS is a program that takes care of the basic level of communication between the CPU and peripherals. It contains codes for various advanced features found in this system board. The BIOS allows you to configure the system and save the configuration in a battery-backed CMOS so that the data retains even when the power is off. In general, the information stored in the CMOS RAM of the EEPROM will stay unchanged unless a configuration change has been made such as a hard drive replaced or a device added.

It is possible that the CMOS battery will fail causing CMOS data loss. If this happens, you need to install a new CMOS battery and reconfigure the BIOS settings.



Note:

The BIOS is constantly updated to improve the performance of the system board; therefore the BIOS screens in this chapter may not appear the same as the actual one. These screens are for reference purpose only.

Default Configuration

Most of the configuration settings are either predefined according to the Load Optimal Defaults settings which are stored in the BIOS or are automatically detected and configured without requiring any actions. There are a few settings that you may need to change depending on your system configuration.

Entering the BIOS Setup Utility

The BIOS Setup Utility can only be operated from the keyboard and all commands are keyboard commands. The commands are available at the right side of each setup screen.

The BIOS Setup Utility does not require an operating system to run. After you power up the system, the BIOS message appears on the screen and the memory count begins. After the memory test, the message "Press DEL to run setup" will appear on the screen. If the message disappears before you respond, restart the system or press the "Reset" button. You may also restart the system by pressing the <Ctrl> <Alt> and keys simultaneously.

Legends

Keys	Function
Right and Left arrows	Moves the highlight left or right to select a menu.
Up and Down arrows	Moves the highlight up or down between submenu or fields.
<Esc>	Exit to the BIOS Setup Utility.
+ / <F5> (plus key)	Scrolls forward through the values or options of the highlighted field.
- / <F6> (minus key)	Scrolls backward through the values or options of the highlighted field.
Tab	Select a field.
<F1>	Displays general help
<F9>	Optimized defaults
<F10>	Saves and resets the setup program.
<Enter>	Press <Enter> to enter the highlighted submenu.

Scroll Bar

When a scroll bar appears to the right of the setup screen, it indicates that there are more available fields not shown on the screen. Use the up and down arrow keys to scroll through all the available fields.

Submenu

When "►" appears on the left of a particular field, it indicates that a submenu which contains additional options are available for that field. To display the submenu, move the highlight to that field and press <Enter>.

Insyde BIOS Setup Utility (for Intel 6th Generation CPU)

Main

The Main menu is the first screen that you will see when you enter the BIOS Setup Utility. For SD330-H110, we support both Intel 6th and 7th generation CPU. If your BIOS indicates that it supports 6th and 7th generation CPU on main menu, please refer page 46~59. For BIOS supporting 6th generation CPU only, please refer page 33~45.

InsydeH20 Setup Utility		Rev. 5.0
Main	Advanced	Security Boot Exit
Project Name	SD330	This is the help for the hour, minute, second field. Valid range is from 0 to 23, 0 to 59, 0 to 59. INCREASE/REDUCE: +/-.
BIOS Version	66.15H	
Processor Type	Intel(R) Core(TM) i7-6700 CPU @ 3.40GHz	
CPUID:	0x506E3 (SKYLAKE DT HALO)	
CPU Speed:	3400 MHz	
CPU Stepping:	03 (R0/S0 Stepping)	
L1 Data Cache:	32 KB	
L1 Instruction Cache:	32 KB	
L2 Cache:	256 KB	
L3 Cache:	8192 KB	
Number of Processors:	4 Core(s) / 8 Thread(s)	
Microcode Rev:	0000006A	
Total Memory	8192 MB	
System Memory Speed	2133 MHz	
Unknown 0	[Not Installed]	
DIMM 1	8192 MB	
PCH Rev / SKU	31 (D1 Stepping) / SKL PCH-H H110	
Intel ME Version / SKU	11.0.0.1205 / CORPORATE	
System Time	[09:51:11]	
System Date	[07/11/2016]	

F1 Help ↑/↓ Select Item F5/F6 Change Values F9 Setup Defaults
Esc Exit ←/→ Select Item Enter Select ► SubMenu F10 Save and Exit

System Time

The time format is <hour>, <minute>, <second>. The time is based on the 24-hour military-time clock. For example, 1 p.m. is 13:00:00. Hour displays hours from 00 to 23. Minute displays minutes from 00 to 59. Second displays seconds from 00 to 59.

System Date

The date format is <month>, <date>, <year>. Month displays the month, from January to December. Date displays the date, from 1 to 31. Year displays the year, from 1980 to 2099.

Advanced

The Advanced menu allows you to configure your system for basic operation. Some entries are defaults required by the system board, while others, if enabled, will improve the performance of your system or let you set some features according to your preference.



Important:

1. Setting incorrect field values may cause the system to malfunction.
2. SD330-H110 does not support Intel AMT function. Thus there is no MEBX Configuration.

InsydeH20 Setup Utility		Rev. 5.0
Main	Advanced	Security Boot Exit
<ul style="list-style-type: none"> ▶ ACPI Configuration ▶ CPU Configuration ▶ Video Configuration ▶ Audio Configuration ▶ SATA Configuration ▶ USB Configuration ▶ PCI Express Configuration ▶ ME Configuration ▶ SIO NUVOTON6106D 		ACPI Configuration Setting

F1 Help ↑/↓ Select Item F5/F6 Change Values F9 Setup Defaults
Esc Exit ←/→ Select Item Enter Select ► SubMenu F10 Save and Exit

ACPI Configuration

This section is used to configure the system ACPI parameters.

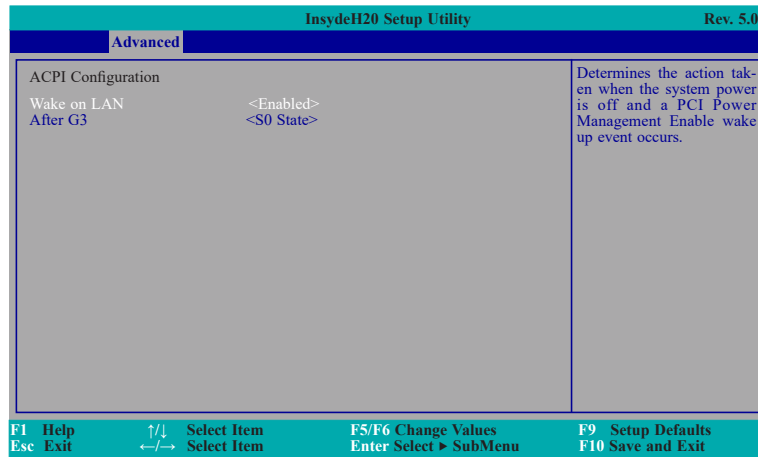

Wake on LAN

This field use to enable or disable the LAN signal to wake up the system.

After G3

This field is to specify what state to go when power is re-applied after a power failue (G3 state).

S0 State The system working state.

S5 State Off, except for trickle current to devices such as the power button.

CPU Configuration

This section is used to configure the CPU.

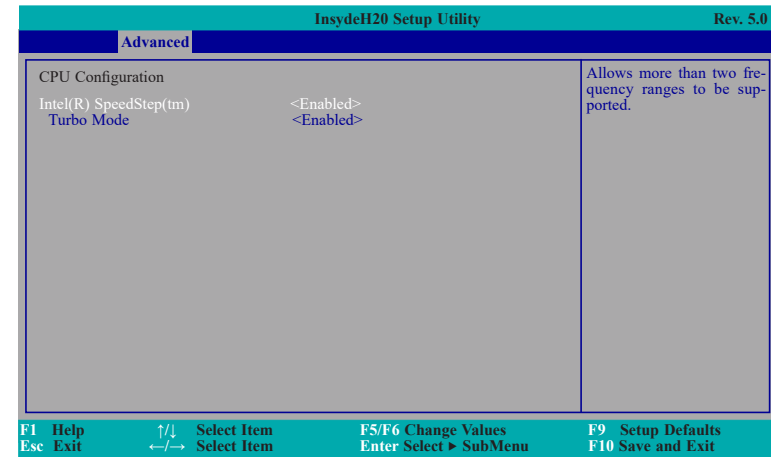

Intel(R) SpeedStep(tm)

This field is used to enable or disable the Intel Enhanced SpeedStep Technology.

Turbo Mode

Enable or disable the turbo mode.

Video Configuration

This section configures the video settings.

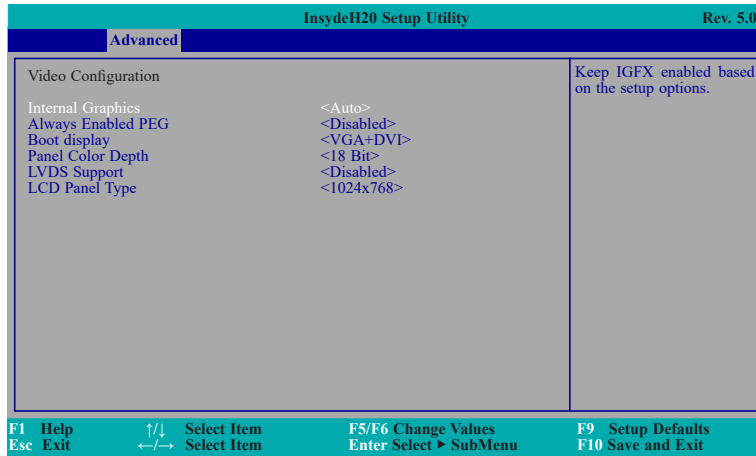

Internal Graphics

Keep IGFX enabled or disabled based on the setup options.

Always Enabled PEG

Enable or disable the PEG function.

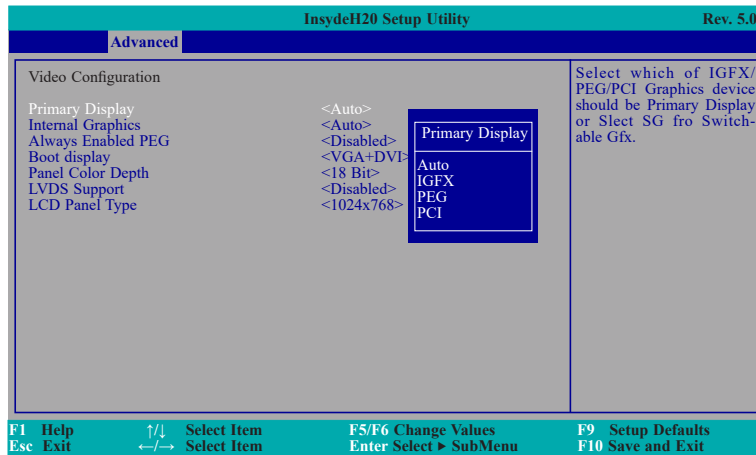

Note:

In order to control "Primary Display" & "Boot Display", you need to go to Boot tab and select different "Boot Type" (Boot Section, Page 43)

Boot Type : Legacy Boot Type -> Hide Primary Display & Show Boot Display

Boot Type : UEFI Boot Type -> Show Primary Display & Hide Boot Display

Boot Type : Dual Boot Type -> Show Primary Display & Show Boot Display

Boot display

Set the display device combination.

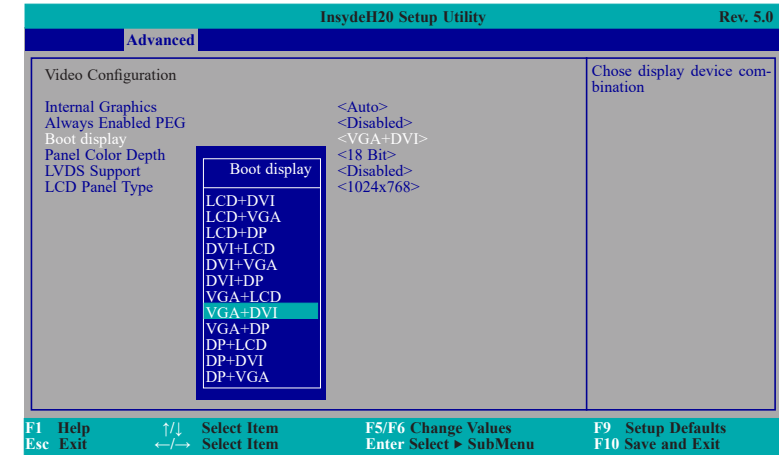

Panel Color Depth

Select the LFP panel color depth: 18 bit, 24 bit, 36 bit, and 48 bit.

LVDS Support

Turn on/off LVDS.

LCD Panel Type

Select the LCD panel type.

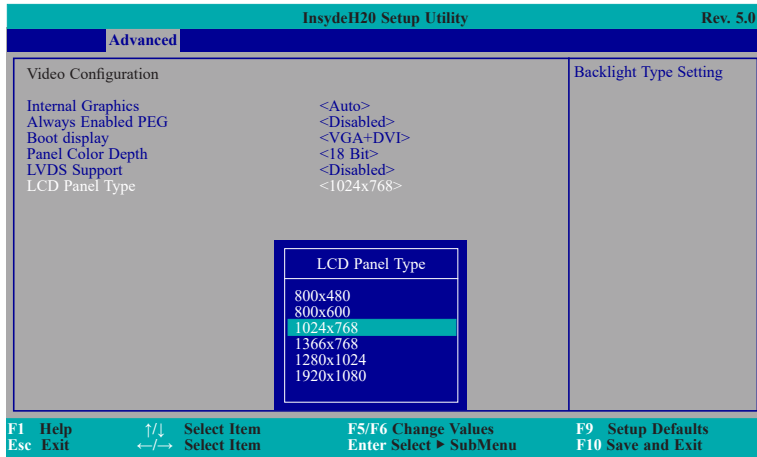

Audio Configuration

This section is used to configure the audio settings.

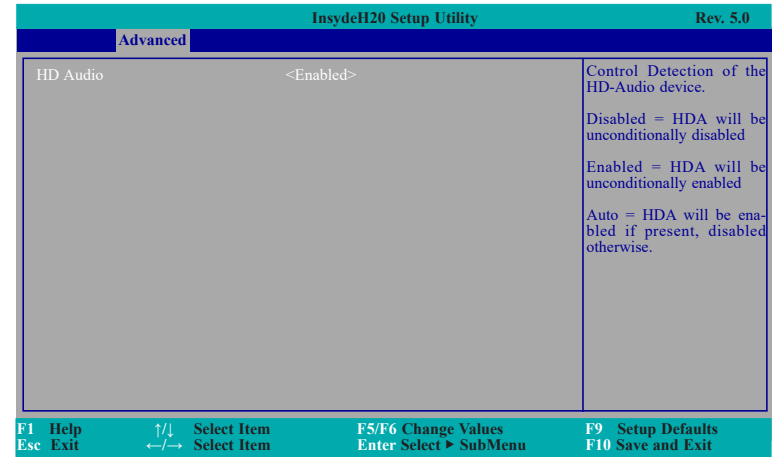

HD Audio

Control the detection of the HD-Audio device.

Disabled

HDA will be unconditionally disabled.

Enabled

HDA will be unconditionally enabled.

Auto

HDA will be enabled if present, disabled otherwise.

SATA Configuration

This section is designed to select the SATA controller and the type of hard disk drive which are installed in your system unit.

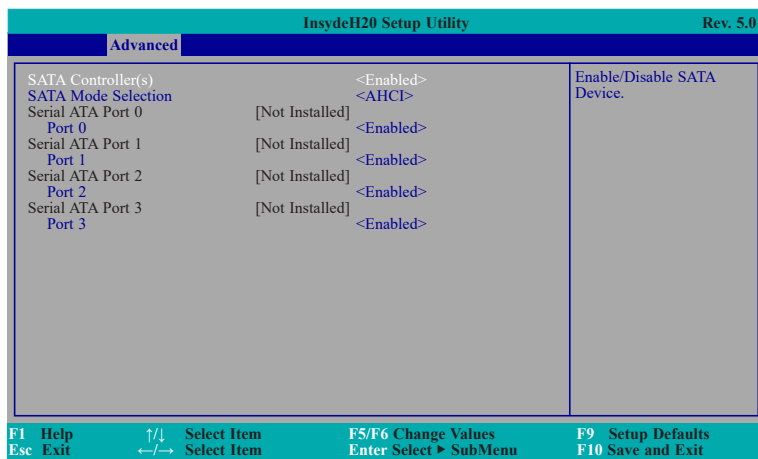

SATA Controller(s)

This field is used to enable or disable Serial ATA devices.

SATA Mode Selection

The mode selection determines how the SATA controller(s) operates.

AHCI Mode

This option allows the Serial ATA devices to use AHCI (Advanced Host Controller Interface).

Serial ATA Port 0, 1, 2 and 3

This field is used to enable or disable the serial ATA port.

USB Configuration

This section is used to configure the parameters of the USB device.

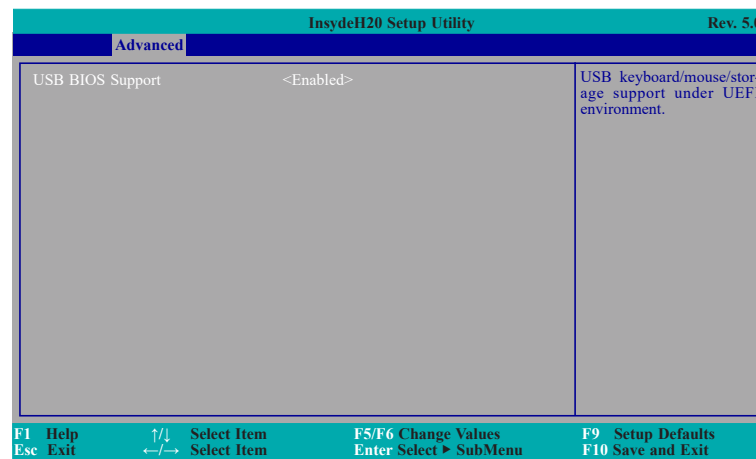

USB BIOS Support

Disabled

Disable USB keyboard/mouse/storage support.

Enabled

Enable USB keyboard/mouse/storage support under UEFI and DOS environment.

PCI Express Configuration

This section configures settings relevant to PCI Express root ports.

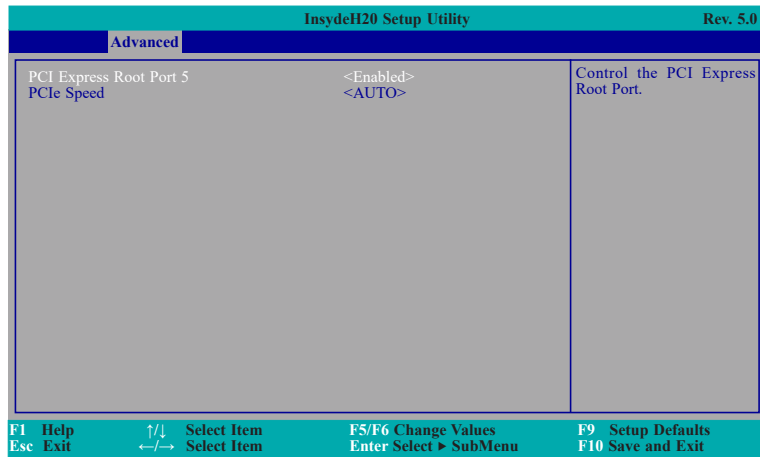
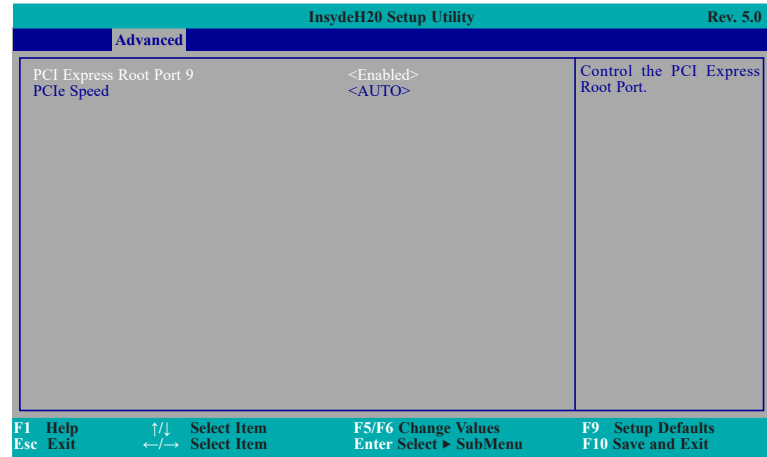
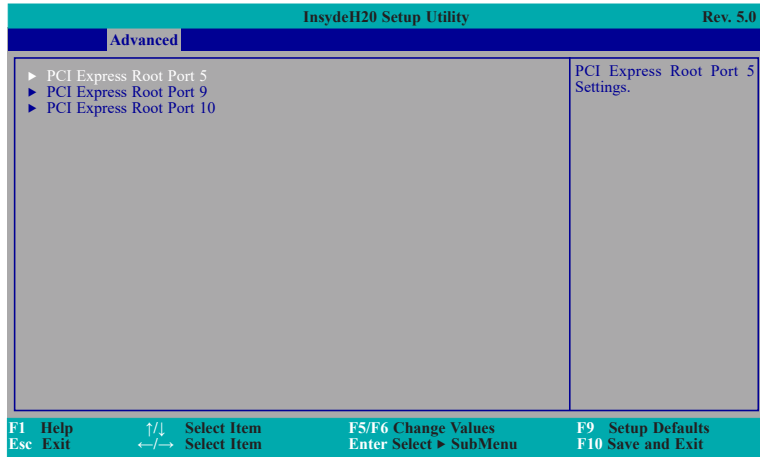

PCI Express Root Port

This field is used to enable or disable the PCI Express Root Port.

PCI Speed

Select the speed of the PCI Express Root Port: Auto, Gen1, Gen2 or Gen3.

ME Configuration

This section configures settings relevant to flash ME region.

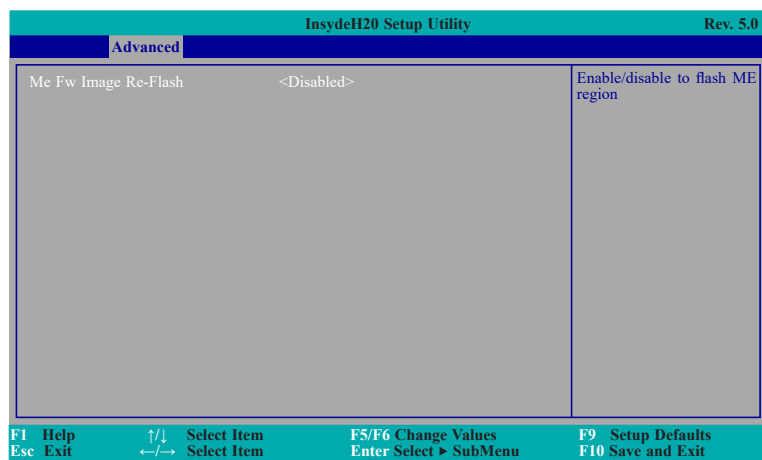

Me Fw Image Re-Flash

This field is used to enable or disable the flash ME region.

SIO NUVOTON6106D

This section configures the system super I/O chip parameters.

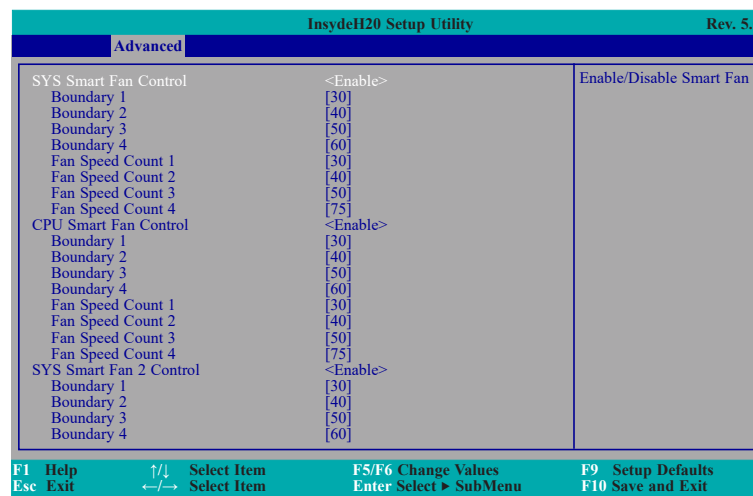

SYS/CPU Smart Fan/Fan 2 Control

Enable or disable the system/CPU smart fan/fan 2.

Boundary 1 to Boundary 4

Set the boundary temperature. The range is from 0-127°C.

Fan Speed Count 1 to Fan Speed Count 4

Set the fan speed. The range is from 1-100%.

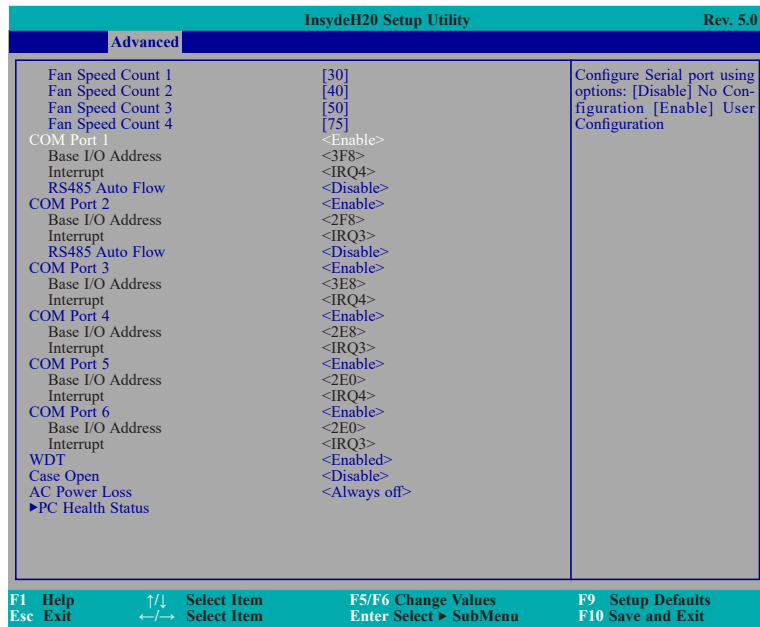

Serial Port 1 to Serial Port 6

Configure the settings to use the serial port.

Disable No configuration

Enable User configuration

RS485 Auto Flow

Choose RS485 auto flow to be enabled or disabled.

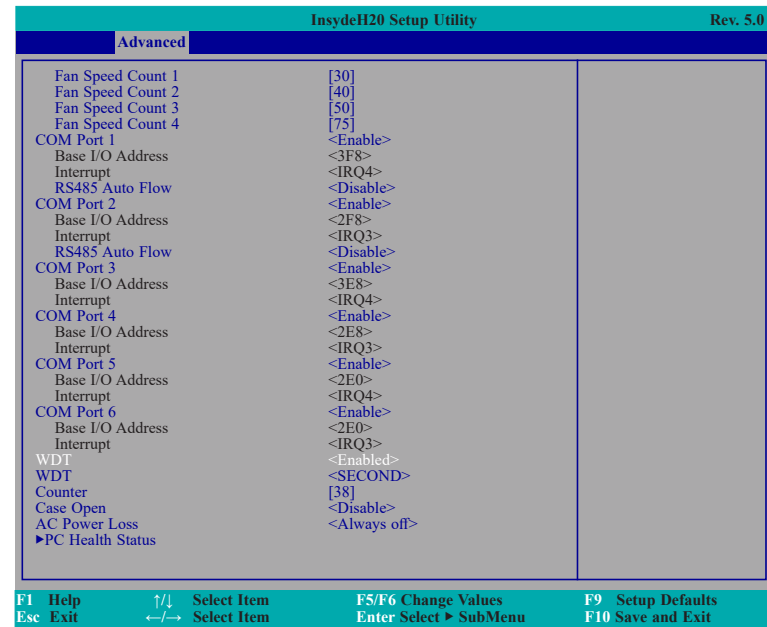

WDT

Enable or disable the watchdog function. A counter will appear if you select to enable WDT. Input any value between 1 to 255.

Case Open

Enable or disable the case open.

AC Power Loss

Set the AC power loss always off/on.

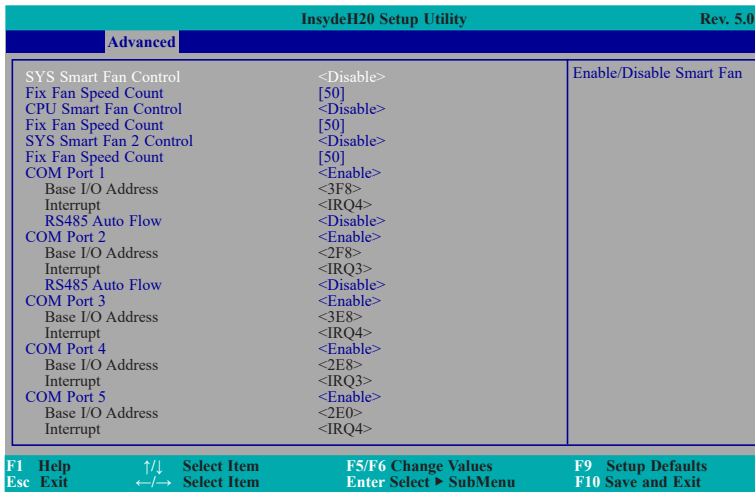

Note: SYS Smart Fan, Fan2 and CPU Smart Fan Control can be switched to <Disable>. When they are disabled, it will enable "Fix Fan Speed Count".

PC Health Status

This field only displays the PC health status.

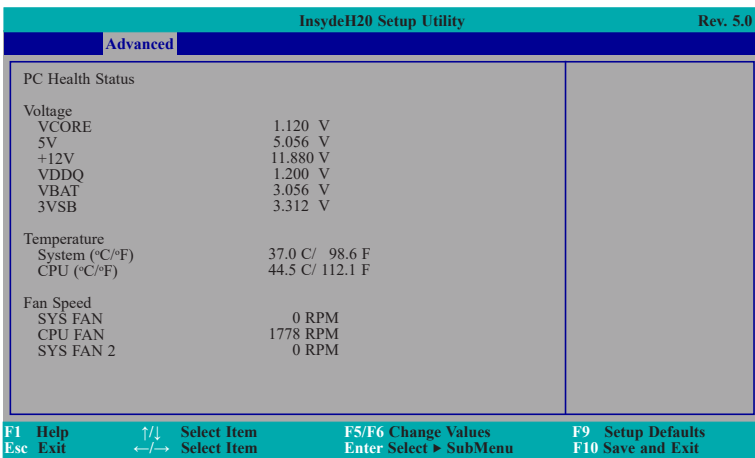

Security

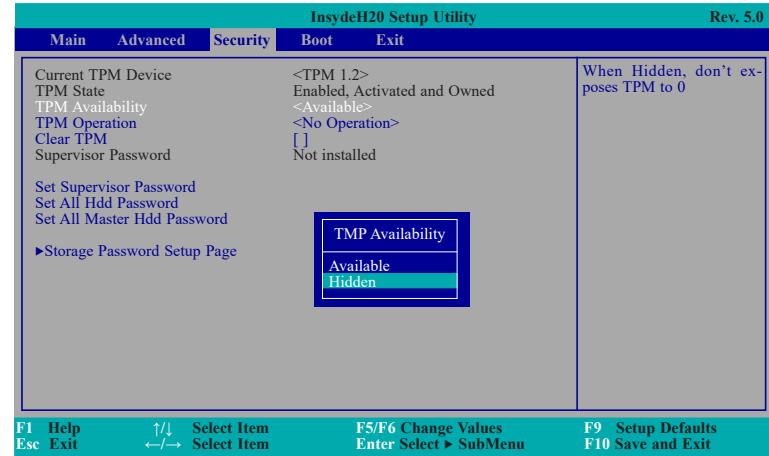

TPM Availability

Set the TPM availability.

TPM Operation

Enable or disable the storage and endorsement hierarchy. This option will automatically return to No-Operation.

Clear TPM

Remove all TPM context associated with a specific owner.

Set Supervisor Password

Set the supervisor's password and the length of the password must be greater than one character.

Set All Hdd Password

Set all HDD password and suggest the length of password greater than one character. This item can be displayed when any security mode of HDD is not Lock.

Set All Master Hdd Password

Set all master HDD password and suggest the length of password greater than one character. This item can be displayed when any security mode of HDD is not Lock.

Storage Password Setup Page

InsydeH20 Setup Utility			Rev. 5.0
Main	Advanced	Security	Boot Exit
Current TPM Device	<TPM 1.2>	Storage Password Setup Page	
TPM State	Enabled, Activated and Owned		
TPM Availability	<Available>		
TPM Operation	<No Operation>		
Clear TPM	[]		
Supervisor Password	Not installed		
Set Supervisor Password			
Set All Hdd Password			
Set All Master Hdd Password			
▶Storage Password Setup Page			

F1 Help ↑/↓ Select Item F5/F6 Change Values F9 Setup Defaults
 Esc Exit ←/→ Select Item Enter Select ▶ SubMenu F10 Save and Exit

Storage Password Setup Page

This option allows you to set up storage password.

InsydeH20 Setup Utility			Rev. 5.0
Main	Advanced	Security	Boot Exit
Storage Password Setup		Storage Password Setup Page	
▶ST3160318AS			
↑ and ↓ to change option. ENTER to select an option. ESC to exit.			

F1 Help ↑/↓ Select Item F5/F6 Change Values F9 Setup Defaults
 Esc Exit ←/→ Select Item Enter Select ▶ SubMenu F10 Save and Exit

ST3160318AS (Device Name)

This option allows you to go to Storage Password List Help.

InsydeH20 Setup Utility			Rev. 5.0
Main	Advanced	Security	Boot Exit
Device Name:	[ST3160318AS]		
Security Mode:	No Accessed		
Set Storage Password			
Set Master Hdd Password			

F1 Help ↑/↓ Select Item F5/F6 Change Values F9 Setup Defaults
 Esc Exit ←/→ Select Item Enter Select ▶ SubMenu F10 Save and Exit

Security Mode Description

Lock: HDD security status is enable and lock.

Unlock: HDD security status is enable and lock.

Change: HDD security status is unlock and user changes to the new password.

Disable: Remove HDD password from device.

No Access: HDD Secutiry status is not enabled when entering SCU.

Set Storage Password

Set all HDD password and suggest the length of password greater than one character.

How to clear HDD password: only press "Enter" when set new password.

Set Master Hdd Password

Set master HDD password and suggest the length of password greater than one character.

When secutiry mode is Lock, input master HDD password to unlock HDD.

Master HDD password is valid when HDD password is set.

Only pressing "Enter" would clear HDD password and make HDD secutiry disable when set new master HDD password.

Boot

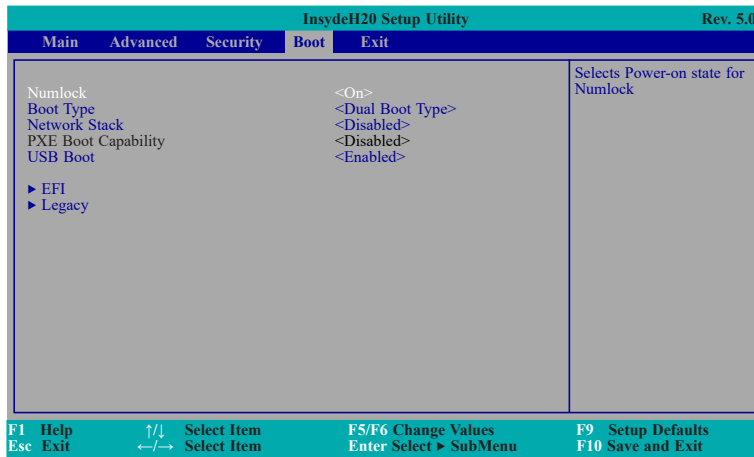

Numlock

Select the power-on state for numlock.

Boot Type

Select the boot type. The options are Dual Boot Type, Legacy Boot Type or UEFI Boot Type.

If you select "Dual Boot" or "UEFI Boot", the "Network Stack", "PXE Boot Capability" and "USB Boot" will show up.

If you select "Legacy Boot", "PXE Boot to LAN" and "USB Boot" will show up.

PXE Boot Capability

Disabled : Support Network Stack
UEFI PXE : IPv4/IPv6
Legacy : Legacy PXE OPROM only

USB Boot

Enable or disable the booting to USB boot devices.

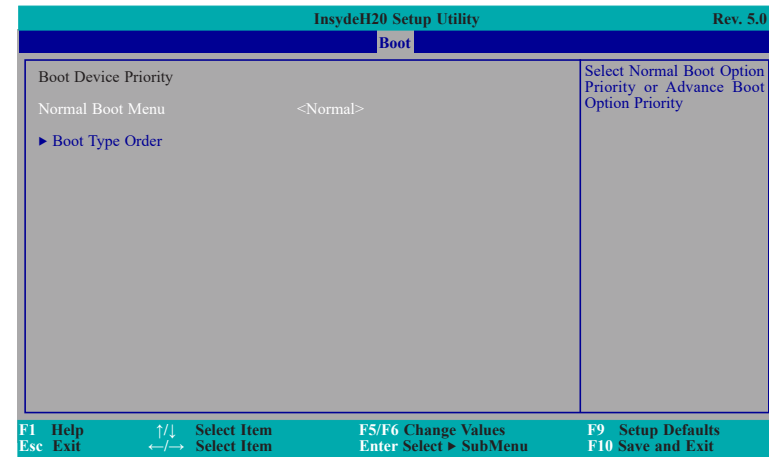

Normal Boot Menu

Normal

Based on the boot normal priority, it determines the EFI device first or the legacy device first.

Advance

All boot devices follow the user's selection sequence.

Boot Type Order

Select the priority of boot type: Normal Boot or Advance Boot.

Legacy

This section is used to set legacy boot order.

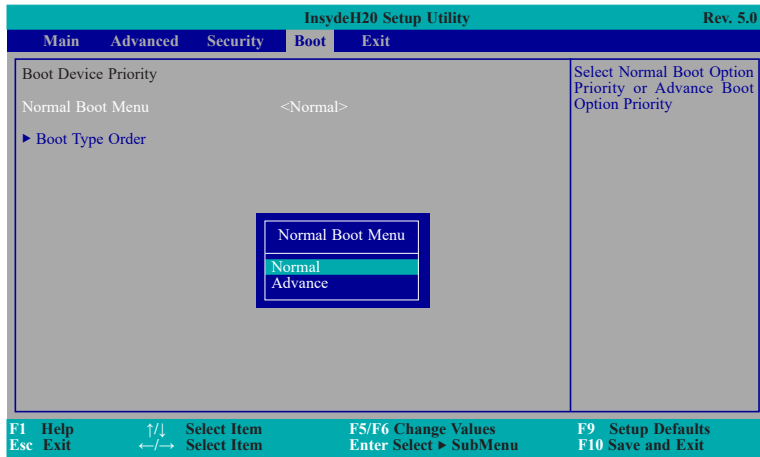

Normal Boot Menu

Normal

Based on the boot normal priority, it determines the EFI device first or the legacy device first.

Advance

All boot devices follow the user's selection sequence. Use + and - keys to arrange the priority of the listed boot devices.

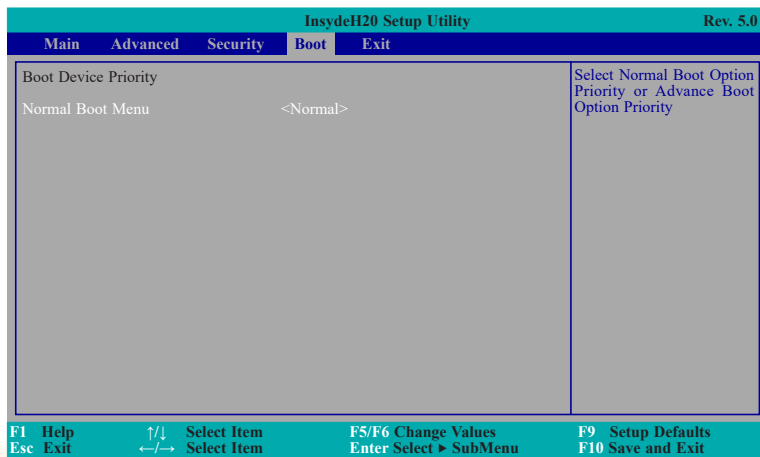

Boot Type Order

Use + and - keys to arrange the sequence of storage devices that the system's hardware checks for the operating system's boot files. The first device in the order list has the first boot priority. For example, to boot from a floppy drive instead of a hard drive, place the floppy drive ahead of the hard drive in priority.

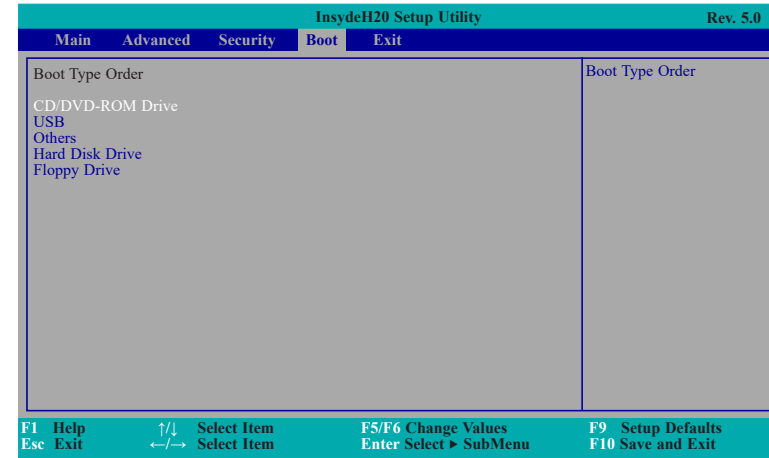

Exit

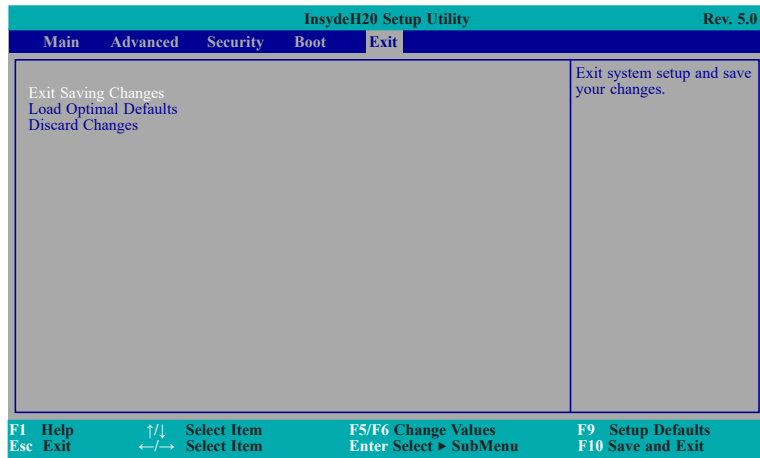

Exit Saving Changes

Select this field and then press <Enter> to exit the system setup and save your changes.

Load Optimal Defaults

Select this field and then press <Enter> to load optimal defaults.

Discard Changes

Select this field and then press <Enter> to exit the system setup without saving your changes.

Insyde BIOS Setup Utility (for Intel 6/7th Generation CPU)

Main

The Main menu is the first screen that you will see when you enter the BIOS Setup Utility. For SD330-H110, we support both Intel 6th and 7th generation CPU. If your BIOS indicates that it supports 6th and 7th generation CPU on main menu, please refer page 46~59. For BIOS supporting 6th generation CPU only, please refer page 33~45.

InsydeH2O Setup Utility		Rev. 5.0
Main	Advanced	Security Boot Exit
Project Name	SD330	This is the help for the hour, minute, second field. Valid range is from 0 to 23, 0 to 59, 0 to 59. INCREASE/REDUCE: +/-.
BIOS Version	B185.11B	
Supported Processor	Intel 6th and 7th Generation CPU	
Processor Type	Intel(R) Core(TM) i5-7500T CPU @ 2.70GHz	
CPUID	0x906E9 (KABYLAKE DT HALO)	
CPU Speed	2700 MHz	
CPU Stepping	09 (KBL B0/S0/M0 Stepping)	
L1 Data Cache	32 KB	
L1 Instruction Cache	32 KB	
L2 Cache	256 KB	
L3 Cache	6144 KB	
Number Of Processors	4 Core(s) / 4 Thread(s)	
Microcode Rev	00000084	
Total Memory	4096 MB	
System Memory Speed	2400 MHz	
DIMM 0	4096 MB	
DIMM 2	[Not Installed]	
PCH Rev / SKU	31 (D1 Stepping) / SKL PCH-H H110	
Intel ME Version / SKU	11.8.50.3399 / CONSUMER	
System Time	[09:05:36]	
System Date	[05/18/2018]	

F1 Help ↑/↓ Select Item **F5/F6 Change Values** **F9 Setup Defaults**
Esc Exit ←/→ Select Item **Enter Select ▶ SubMenu** **F10 Save and Exit**

System Time

The time format is <hour>, <minute>, <second>. The time is based on the 24-hour military-time clock. For example, 1 p.m. is 13:00:00. Hour displays hours from 00 to 23. Minute displays minutes from 00 to 59. Second displays seconds from 00 to 59.

System Date

The date format is <month>, <date>, <year>. Month displays the month, from 01 to 12. Date displays the date, from 01 to 31. Year displays the year, from 2000 to 2099.

Advanced

The Advanced menu allows you to configure your system for basic operation. Some entries are defaults required by the system board, while others, if enabled, will improve the performance of your system or let you set some features according to your preference.



Important:

Setting incorrect field values may cause the system to malfunction.

InsydeH2O Setup Utility		Rev. 5.0
Main	Advanced	Security Boot Exit
▶ACPI Configuration		ACPI Configuration Setting
▶CPU Configuration		
▶Video Configuration		
▶Audio Configuration		
▶SATA Configuration		
▶USB Configuration		
▶PCI Express Configuration		
▶ME Configuration		
▶Debug Configuration		
▶UEFI Device Manager		
▶SIO NUVOTON6106D		
▶Console Redirection		

F1 Help ↑/↓ Select Item **F5/F6 Change Values** **F9 Setup Defaults**
Esc Exit ←/→ Select Item **Enter Select ▶ SubMenu** **F10 Save and Exit**



Note:

SD330-H110 does not support Intel Active Management Technology (Intel® AMT). Thus there is no MEBX Configuration.

ACPI Configuration

This section is used to configure the system ACPI parameters.

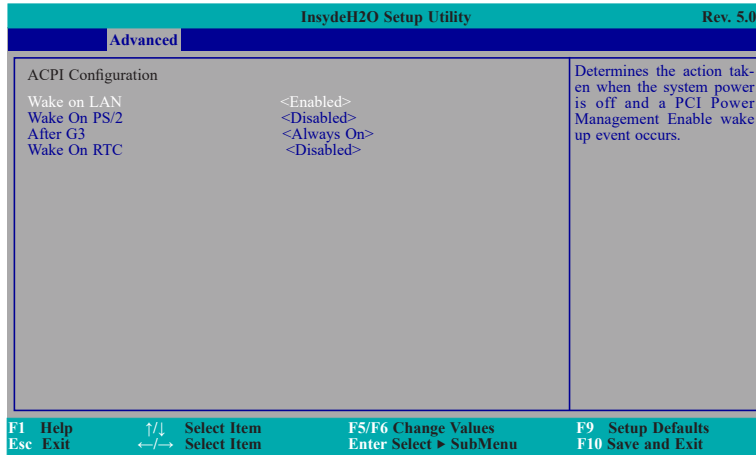

Wake on LAN

This field is used to enable or disable the LAN signal to wake up the system.

Wake On PS/2

This field is used to enable or disable the PS/2 device to wake up the system.

After G3

This field is to specify what state to go when power is re-applied after a power failure (G3 state).

Always On The system working state.

Always Off Off, except for trickle current to devices such as the power button.

Wake On RTC

Automatically power the system on at a particular time every day from the Real-time clock battery.

Wake up time

When Wake On RTC is set to enabled, specify the wake up time of the day: <hour> (00~23), <minute> (00~59), <second> (00~59).



Note:

Under Dual Boot Type or UEFI Boot Type mode, if Quiet Boot is set to enabled, BGRT Logo field will appear for configuration. Refer to the Boot menu (page 58) for more information.

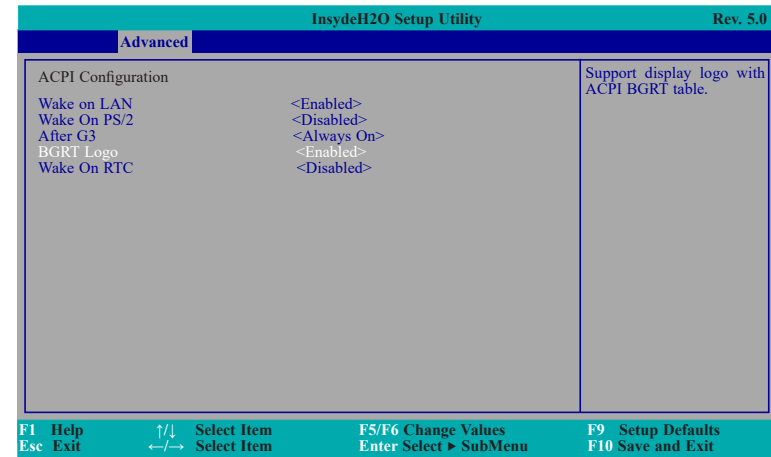

BGRT Logo

This field is used to enable or disable to support display logo with ACPI BGRT table.

CPU Configuration

This section is used to configure the CPU.

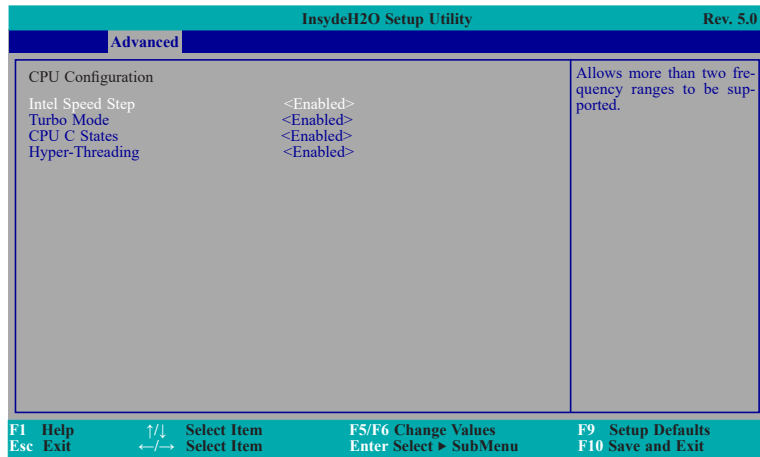

Intel Speed Step

This field is used to enable or disable the Intel Enhanced SpeedStep Technology.

Turbo Mode

Enable or disable the turbo mode.

CPU C States

Enable or disable the CPU Power Management.

Hyper-Threading

Enables this field for Windows XP and Linux which are optimized for Hyper-Threading technology. Select disabled for other OSes not optimized for Hyper-Threading technology. When disabled, only one thread per enabled core is enabled.

Video Configuration

This section configures the video settings.

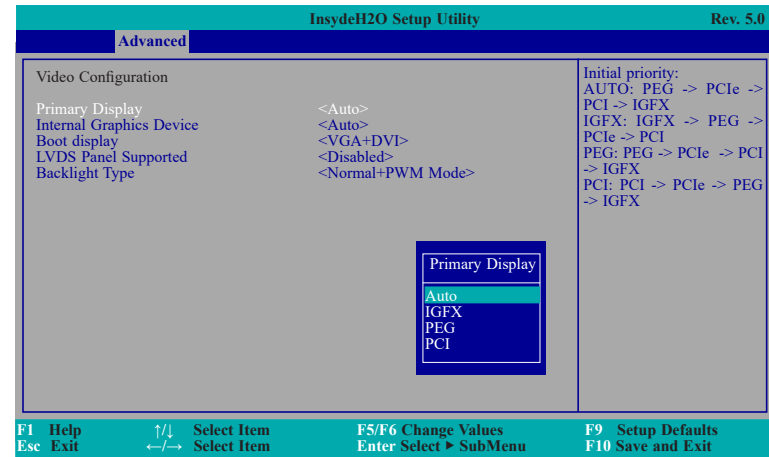

Primary display

Set the initial priority.

Internal Graphics Device

Keep IGFX enabled or disabled based on the setup options.

Boot display

Set the display device combination.



Note:

To control "Primary Display" & "Boot Display", first go to "Boot" menu and select different "Boot Type" (page 58).

Boot Type : Legacy Boot Type -> Hide Primary Display & Show Boot Display

Boot Type : UEFI Boot Type -> Show Primary Display & Hide Boot Display

Boot Type : Dual Boot Type -> Show Primary Display & Show Boot Display

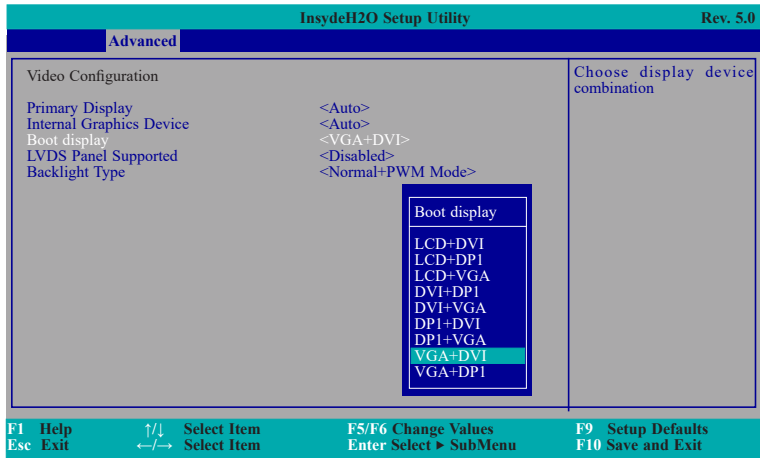

LVDS Panel Supported

Enable or disable PTN3460 function for LVDS panel. If enabled, PTN3460 Configuration and LCD Panel Type will show up for configuration.

PTN3460 Configuration

Set the PTN3460 color depth: 18 bit, 24 bit, 36 bit or 48 bit.

LCD Panel Type

Please check the specifications of your LCD monitor. Select the type of LCD panel connected to the system's LCD connector: VBIOS Default, 800x480, 800x600, 1024x768, 1366x768, 1280x1024 or 1920x1080.

Backlight Type

Set the backlight type: Normal+PWM Mode, Normal+DC Mode, Invert+PWM Mode or Invert+DC Mode.

Audio Configuration

This section is used to configure the audio settings.

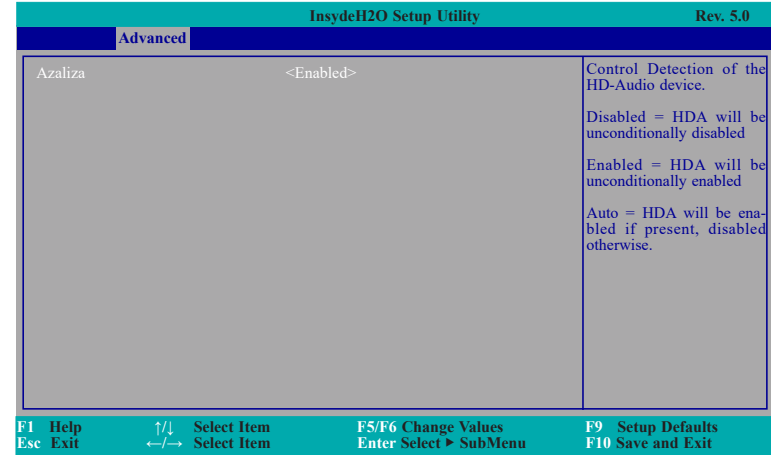

Azalizia

Control the detection of the Azalizia device.

Disabled

HDA will be unconditionally disabled.

Enabled

HDA will be unconditionally enabled.

Auto

HDA will be enabled if present, disabled otherwise.

SATA Configuration

This section is designed to select the SATA controller and the type of hard disk drive which are installed in your system unit.

InsydeH2O Setup Utility		Rev. 5.0
Advanced		
SATA Controller(s)	<Enabled>	Enable/Disable SATA Device.
SATA Speed	<Auto>	
SATA Mode Selection	<AHCI>	
Serial ATA Port 0	[Not Installed]	
Port 0	<Enabled>	
Hot Plug	<Disabled>	
Serial ATA Port 1	[Not Installed]	
Port 1	<Enabled>	
Hot Plug	<Disabled>	
Serial ATA Port 2	[Not Installed]	
Port 2	<Enabled>	
Hot Plug	<Disabled>	
Serial ATA Port 3	[Not Installed]	
Port 3	<Enabled>	
Hot Plug	<Disabled>	

F1 Help ↑/↓ Select Item F5/F6 Change Values F9 Setup Defaults
 Esc Exit ←/→ Select Item Enter Select ► SubMenu F10 Save and Exit

SATA Controller(s)

This field is used to enable or disable Serial ATA devices.

SATA Speed

This field is used to select SATA speed generation limit: Auto, Gen1, Gen2 or Gen3.

SATA Mode Selection

The mode selection determines how the SATA controller(s) operates.

AHCI Mode

This option allows the Serial ATA devices to use AHCI (Advanced Host Controller Interface).

Serial ATA Port 0, 1, 2, 3 and Hot Plug

These fields are used to enable or disable the serial ATA port and its hot plug.

USB Configuration

This section is used to configure the parameters of the USB device.

InsydeH2O Setup Utility		Rev. 5.0
Advanced		
Legacy USB Support	<Enabled>	USB keyboard/mouse/storage support under UEFI and DOS environment. It will supporting UEFI environment only if set to UEFI Only
XHCI Hand-off	<Disabled>	

F1 Help ↑/↓ Select Item F5/F6 Change Values F9 Setup Defaults
 Esc Exit ←/→ Select Item Enter Select ► SubMenu F10 Save and Exit

Legacy USB Support

Disabled

Disable USB keyboard/mouse/storage support under UEFI and DOS environment.

Enabled

Enable USB keyboard/mouse/storage support under UEFI and DOS environment.

UEFI Only

Enable USB keyboard/mouse/storage support under UEFI environment.

XHCI Hand-off

Enable or disable to clear XHCI controller ownership change SMI bit by BIOS.

PCI Express Configuration

This section configures settings relevant to PCI Express root ports.

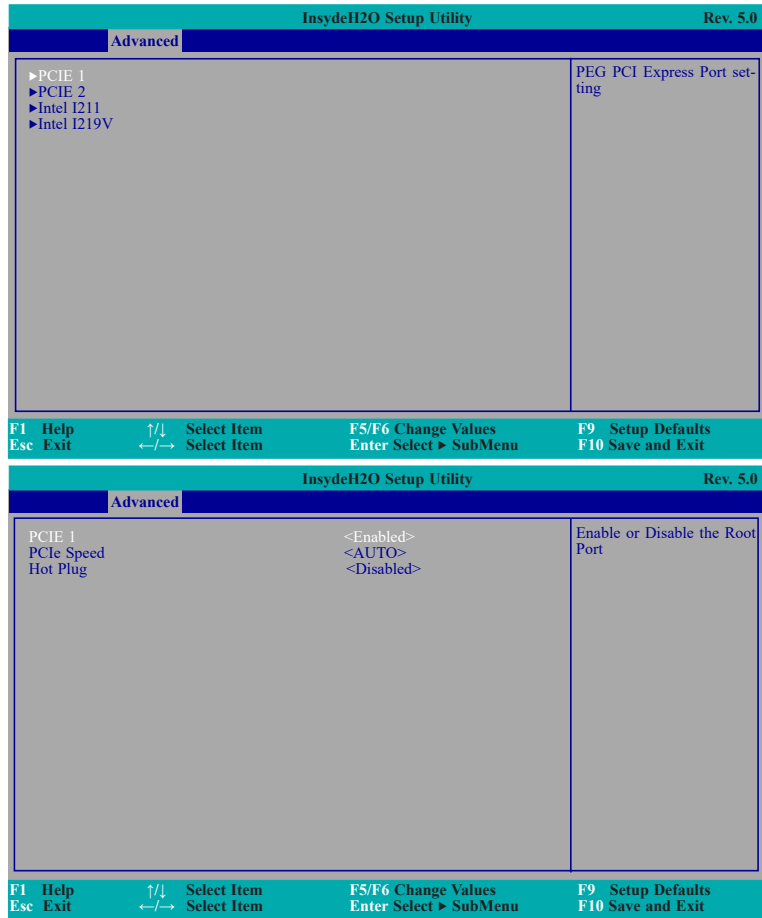

PCI E 1 to PCI E 2

This field is used to enable or disable the PCI Express Root Port.

PCIe Speed

Select the speed of the PCI Express Root Port: Auto, Gen1, Gen2 or Gen3.

Hot Plug

This field is used to enable or disable the PCI Express Hot Plug.

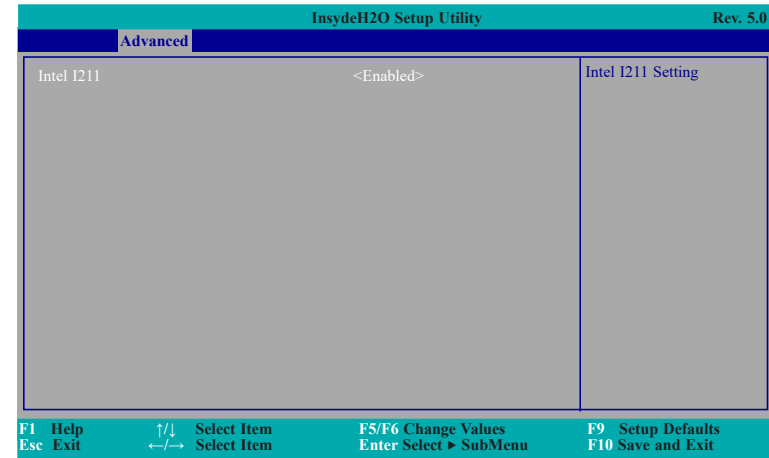

Intel I211

This field is used to enable or disable the Intel I211 setting.

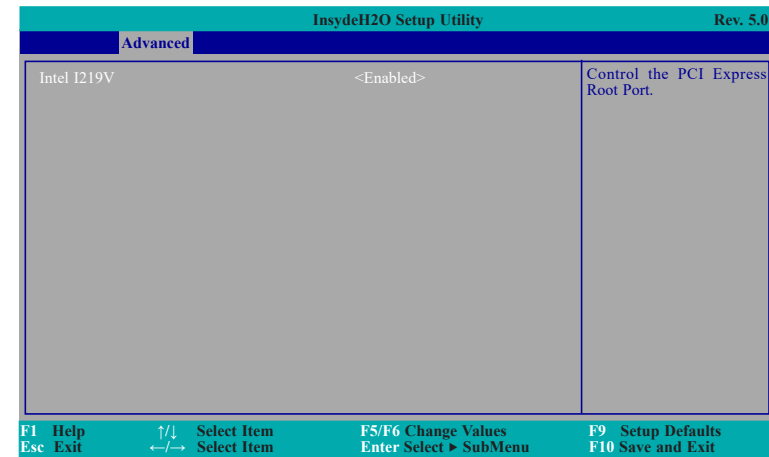

Intel I219V

This field is used to enable or disable the PCI Express Root Port.

ME Configuration

This section configures settings relevant to flash ME region.

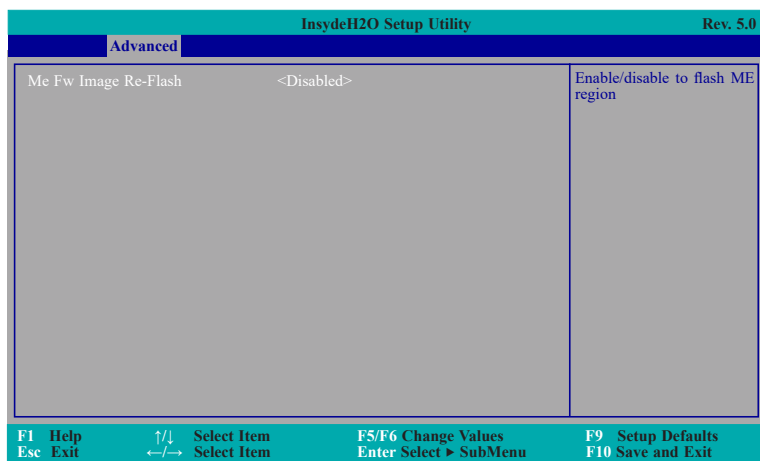

Me Fw Image Re-Flash

This field is used to enable or disable the flash ME region.

Debug Configuration

This section configures debug setting.

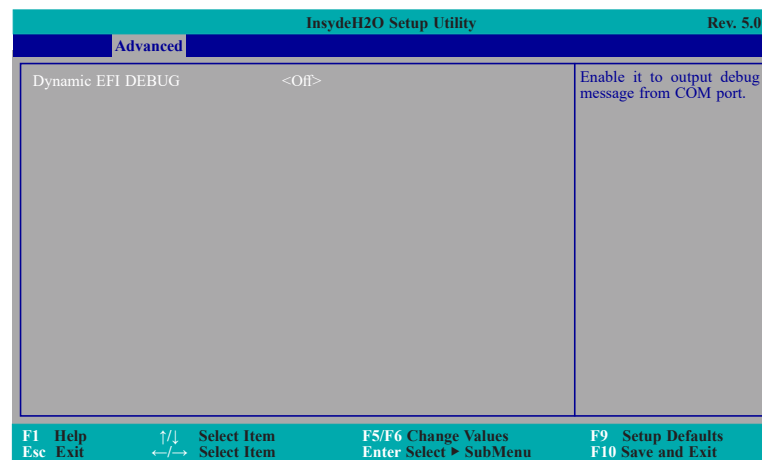

Dynamic EFI DEBUG

This field is used to turn on or off the function to output debug message from COM port. When set to on, relevant EFI debug information will appear as below.

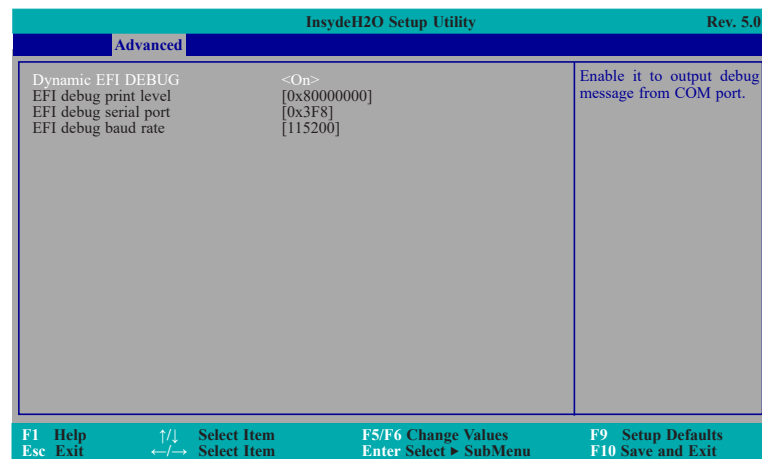

UEFI Device Manager

The section configures UEFI device with option ROM, such as LAN card, etc.

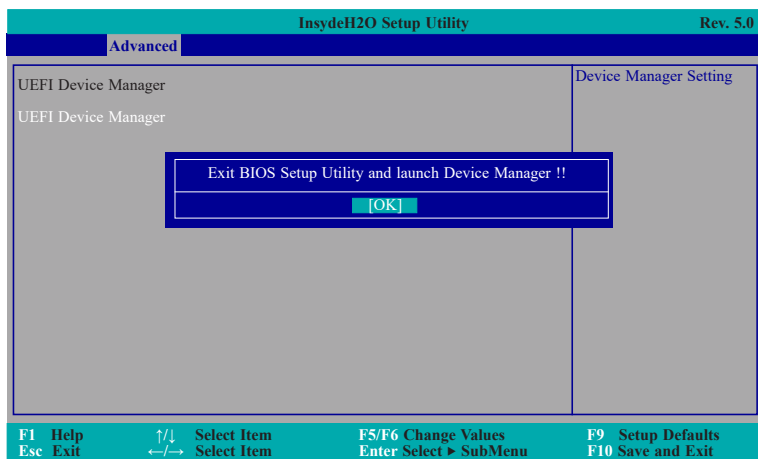

SIO NUVOTON6106D

This section configures the system super I/O chip parameters.

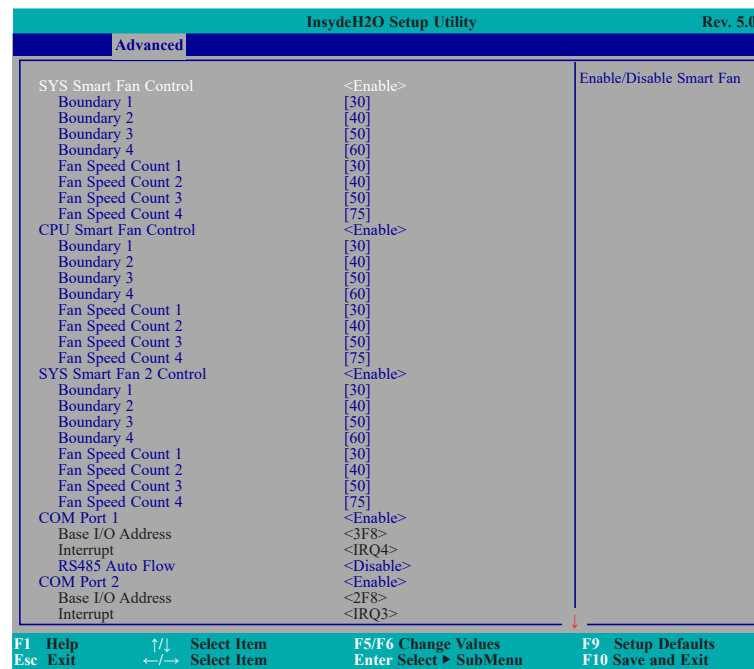

SYS Smart Fan, CPU Smart Fan and SYS Smart Fan 2 Control

Enable or disable the system/CPU smart fan/fan 2.

Boundary 1 to Boundary 4

Set the boundary temperatures that determine the operation of the fan with different fan speeds accordingly. For example, when the system or the CPU temperature reaches boundary temperature 1, the system or CPU fan should be turned on and operate at the designated speed. The range is from 0-127°C.

Fan Speed Count 1 to Fan Speed Count 4

Set the fan speed. The range is from 1-100% (full speed).



Note: SYS Smart Fan Control, CPU Smart Fan Control, and SYS Smart Fan 2 Control can be switched to <Disable>. When they are disabled, it will enable "Fix Fan Speed Count".

InsydeH20 Setup Utility		Rev. 5.0
Advanced		
SYS Smart Fan Control	<Disable>	Fan Speed set from 1-100%
Fix Fan Speed Count	[50]	
CPU Smart Fan Control	<Disable>	
Fix Fan Speed Count	[50]	
SYS Smart Fan 2 Control	<Disable>	
Fix Fan Speed Count	[50]	
COM Port 1	<Enable>	
Base I/O Address	<3F8>	
Interrupt	<IRQ4>	
RS485 Auto Flow	<Disable>	
COM Port 2	<Enable>	
Base I/O Address	<2F8>	
Interrupt	<IRQ3>	
RS485 Auto Flow	<Disable>	
COM Port 3	<Enable>	
Base I/O Address	<3E8>	
Interrupt	<IRQ4>	
COM Port 4	<Enable>	
Base I/O Address	<2E8>	
Interrupt	<IRQ3>	
COM Port 5	<Enable>	
Base I/O Address	<2F0>	
Interrupt	<IRQ4>	
COM Port 6	<Enable>	
Base I/O Address	<2E0>	
Interrupt	<IRQ3>	
WDT	<Disable>	
Case Open	<Disable>	
►PC Health Status		

InsydeH20 Setup Utility		Rev. 5.0
Advanced		
Fan Speed Count 3	[50]	
Fan Speed Count 4	[75]	
SYS Smart Fan 2 Control	<Enable>	
Boundary 1	[30]	
Boundary 2	[40]	
Boundary 3	[50]	
Boundary 4	[60]	
Fan Speed Count 1	[30]	
Fan Speed Count 2	[40]	
Fan Speed Count 3	[50]	
Fan Speed Count 4	[75]	
COM Port 1	<Enable>	
Base I/O Address	<3F8>	
Interrupt	<IRQ4>	
RS485 Auto Flow	<Disable>	
COM Port 2	<Enable>	
Base I/O Address	<2F8>	
Interrupt	<IRQ3>	
RS485 Auto Flow	<Disable>	
COM Port 3	<Enable>	
Base I/O Address	<3E8>	
Interrupt	<IRQ4>	
COM Port 4	<Enable>	
Base I/O Address	<2E8>	
Interrupt	<IRQ3>	
COM Port 5	<Enable>	
Base I/O Address	<2F0>	
Interrupt	<IRQ4>	
COM Port 6	<Enable>	
Base I/O Address	<2E0>	
Interrupt	<IRQ3>	
WDT	<Disable>	
Case Open	<Disable>	
►PC Health Status		

F1 Help ↑/↓ Select Item F5/F6 Change Values F9 Setup Defaults
Esc Exit ←/→ Select Item Enter Select ► SubMenu F10 Save and Exit

COM Port 1 to COM Port 6

Configure the settings to use the serial port.

Disable No configuration

Enable User configuration

RS485 Auto Flow

Enable or disable RS485 auto flow.

WDT

Enable or disable the watchdog function. A counter will appear if you select to enable WDT. Input any value between 1 to 255 seconds.

Case Open

Enable or disable the case open detection function.

PC Health Status

This section displays the PC health status.

InsydeH2O Setup Utility		Rev. 5.0
Advanced		
PC Health Status		
Voltage		
VBAT	3.056 V	
VCORE	0.896 V	
VDDQ	1.200 V	
5V	4.900 V	
+12V	12.144 V	
Temperature		
System (°C/°F)	36.5 C/ 97.7 F	
CPU (°C/°F)	39.0 C/ 102.2 F	
Fan Speed		
SYS FAN	0 RPM	
CPU FAN	6081 RPM	
SYS FAN 2	0 RPM	

F1 Help ↑/↓ Select Item F5/F6 Change Values F9 Setup Defaults
Esc Exit ←/→ Select Item Enter Select ► SubMenu F10 Save and Exit

Console Redirection

This section configures settings relevant to console redirection.

InsydeH2O Setup Utility		Rev. 5.0
Advanced		
Console Redirection Setup		Enable Console Redirection Function
Console Serial Redirect	<Disabled>	

F1 Help ↑/↓ Select Item F5/F6 Change Values F9 Setup Defaults
Esc Exit ←/→ Select Item Enter Select ► SubMenu F10 Save and Exit

Console Serial Redirect

This field is used to enable or disable the console serial redirection function.

When Console Serial Redirect is set to enabled, the screen will appear like below:

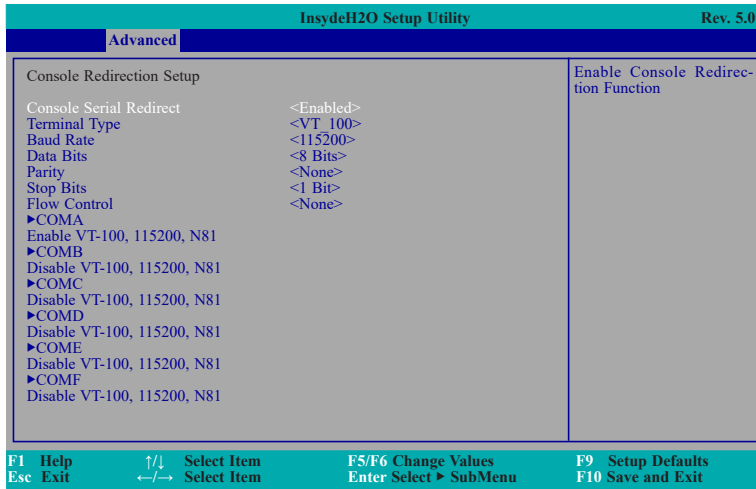

Terminal Type

Select terminal type: VT_100, VT_100+, VT_UTF8 or PC_ANSI.

Baud Rate

Select baud rate: 115200, 57600, 38400, 19200, 9600, 4800, 2400 or 1200.

Data Bits

Select data bits: 7 bits or 8 bits.

Parity

Select parity bits: none, even or odd.

Stop Bits

Select stop bits: 1 bit or 2 bits.

Flow Control

Select flow control type: none, RTS/CTS or XON/XOFF.

COMA to COMF

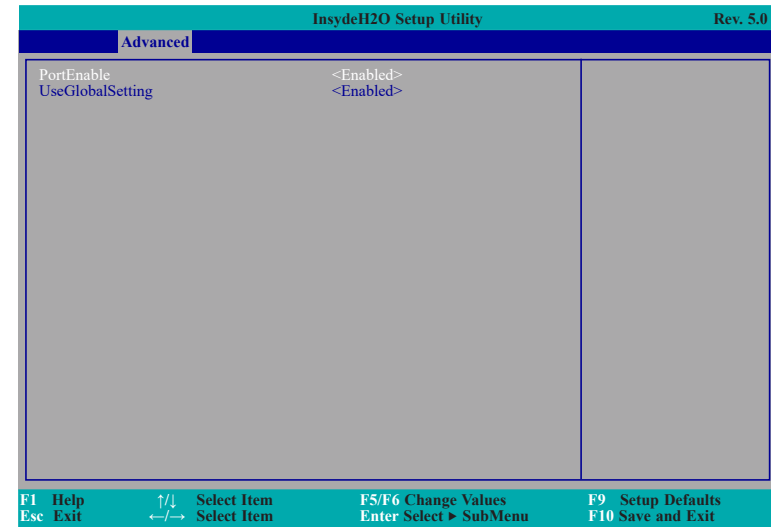

PortEnable

This field is used to enable or disable the COM port to redirect the console.

UseGlobalSetting

This field is to enable or disable to use global setting. When enabled the global setting, setting of the COM port will be the same as those in Console Redirection section. When disabled the global setting, setting of the COM port can be configured independently in this section.

When UseGlobalSetting is set to disabled, the screen will appear like shown below:

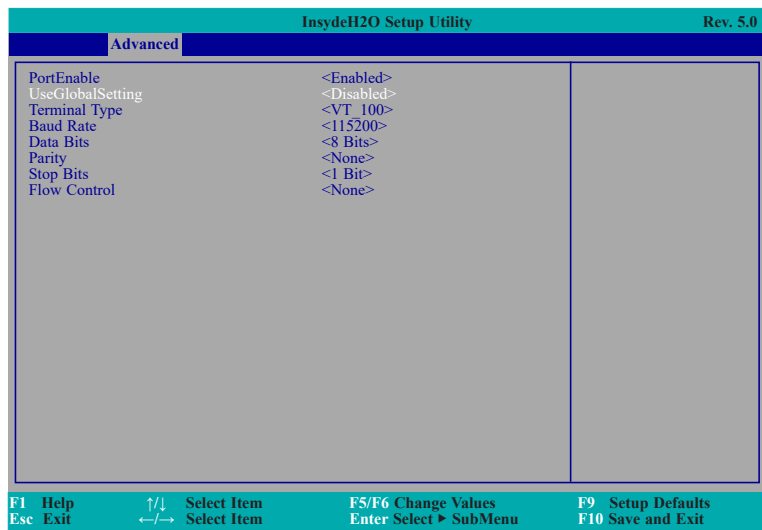

Security

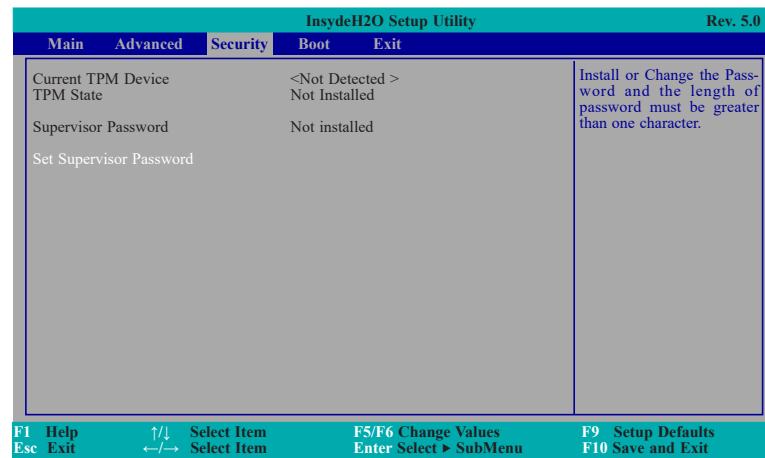

Set Supervisor Password

Set the supervisor's password and the length of the password must be greater than one character.

Boot

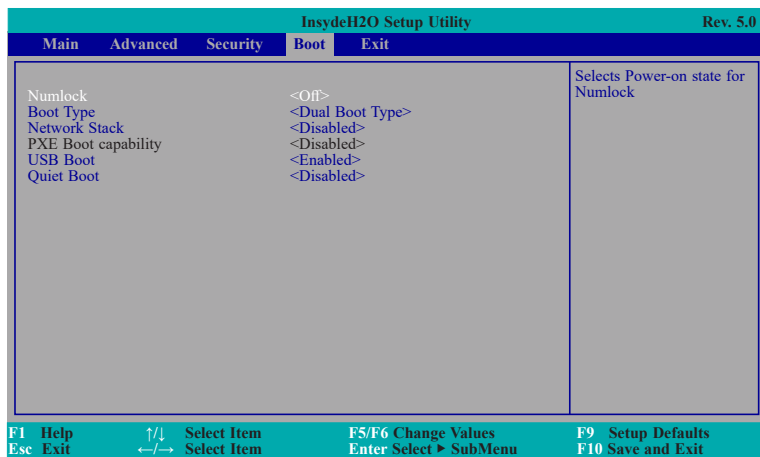

Numlock

Select the power-on state for numlock.

Boot Type

Select the boot type. The options are Dual Boot Type, Legacy Boot Type or UEFI Boot Type.

If you select "Dual Boot Type" or "UEFI Boot Type", the "Network Stack", "PXE Boot capability", "USB Boot" and "Quiet Boot" will show up.

If you select "Legacy Boot Type", "PXE Boot to LAN", "USB Boot" and "Quiet Boot" will show up.

Network Stack

This field is used to enable or disable network stack.

PXE Boot capability

Disabled Support Network Stack

UEFI IPv4/IPv6

Legacy Legacy PXE OPROM only

PXE Boot to LAN

Disable or enable PXE boot to LAN.

USB Boot

Enable or disable to change USB boot devices boot order.

Quiet Boot

Enable or disable booting in text mode.

Exit

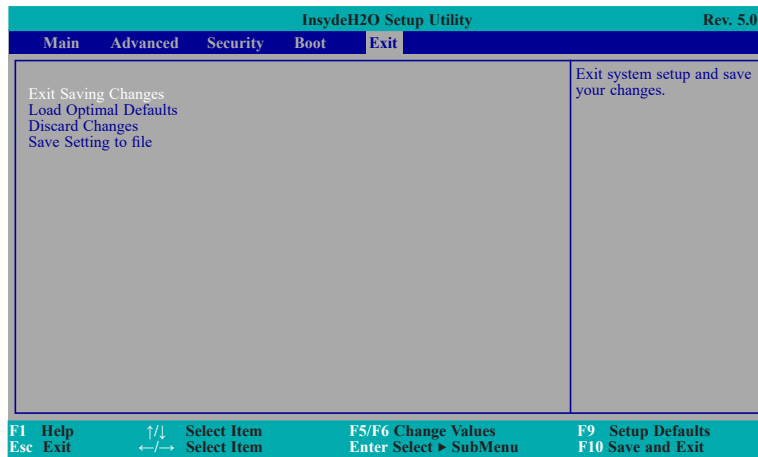

Exit Saving Changes

Select Yes and then press <Enter> to exit the system setup and save your changes.

Load Optimal Defaults

Select YES and then press <Enter> to load optimal defaults.

Discard Changes

Select YES and then press <Enter> to exit the system setup without saving your changes.

Save Setting to file

Select this option to save BIOS configuration settings to a USB flash device.

Restore Setting from file

This field will appear only when a USB flash device is detected. Select this field to restore setting from the USB flash device.

Updating the BIOS

To update the BIOS, you will need the new BIOS file and a flash utility. Please contact technical support or your sales representative for the files and specific instructions about how to update BIOS with the flash utility.

Notice: BIOS SPI ROM

1. The Intel® Management Engine has already been integrated into this system board. Due to the safety concerns, the BIOS (SPI ROM) chip cannot be removed from this system board and used on another system board of the same model.
2. The BIOS (SPI ROM) on this system board must be the original equipment from the factory and cannot be used to replace one which has been utilized on other system boards.
3. If you do not follow the methods above, the Intel® Management Engine will not be updated and will cease to be effective.



Note:

- a. You can take advantage of flash tools to update the default configuration of the BIOS (SPI ROM) to the latest version anytime.
- b. When the BIOS IC needs to be replaced, you have to populate it properly onto the system board after the EEPROM programmer has been burned and follow the technical person's instructions to confirm that the MAC address should be burned or not.

Chapter 4 - Supported Software

Please download drivers, utilities and software applications required to enhance the performance of the system board at <https://www.dfi.com/DownloadCenter>.

Intel Chipset Software Installation Utility

The Intel Chipset Software Installation Utility is used for updating Windows® INF files so that the Intel chipset can be recognized and configured properly in the system.

To install the utility, download "SD330 Chipset Driver" zip file at our website.

1. Setup is ready to install the utility. Click "Next".

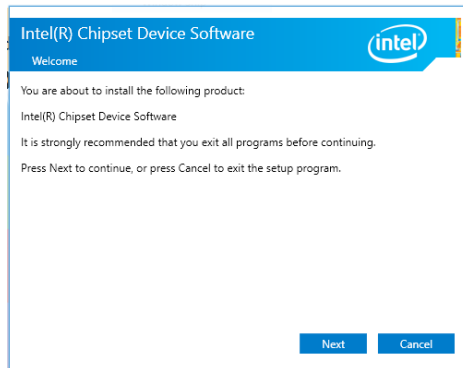

2. Read the license agreement then click "Accept".

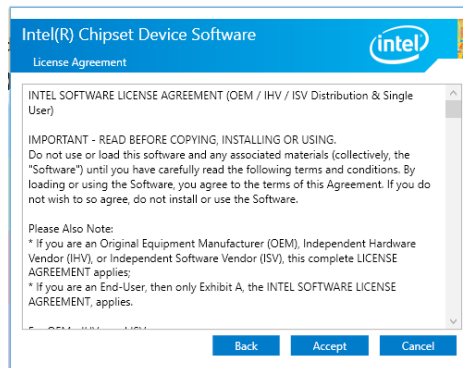

3. Go through the readme document for more installation tips then click "Install".

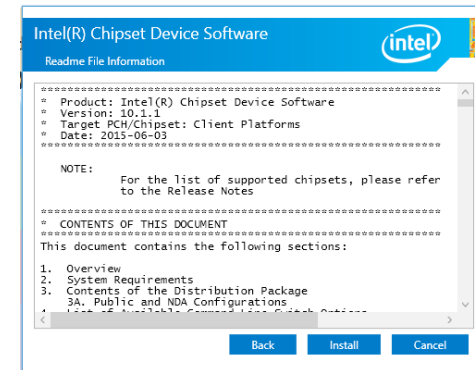

4. The step displays the installing status in the progress.

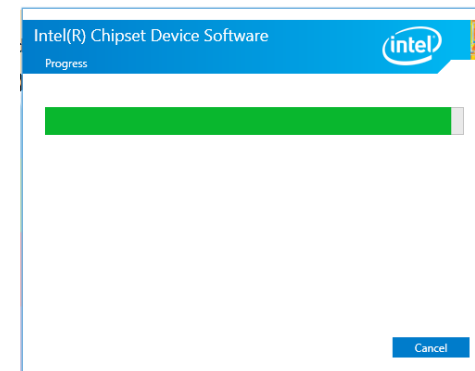

5. After completing installation, click "Restart Now" to exit setup.

Restarting the system will allow the new software installation to take effect.

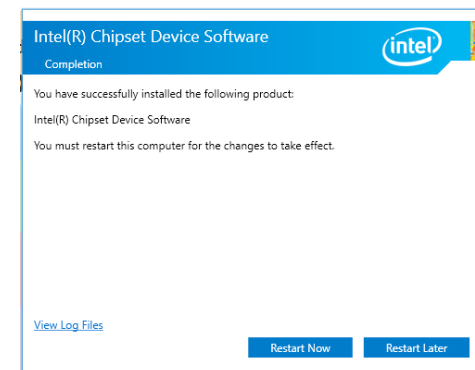

Intel Graphics Drivers

To install the driver, download "SD330 Graphics Driver" zip file at our website.

1. Setup is now ready to install the graphics driver. Click "Next".

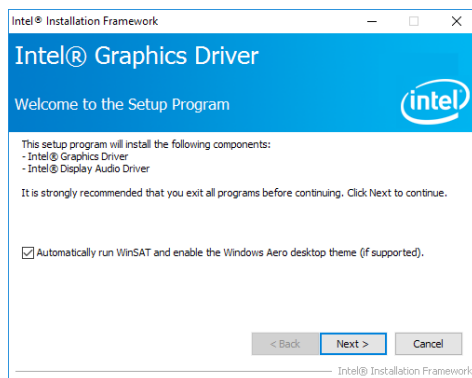

By default, the "Automatically run WinSAT and enable the Windows Aero desktop theme" is enabled. With this enabled, after installing the graphics driver and the system rebooted, the screen will turn blank for 1 to 2 minutes (while WinSAT is running) before the Windows 7/8.1/10 desktop appears. The "blank screen" period is the time Windows is testing the graphics performance.

We recommend that you skip this process by disabling this function then click "Next".

2. Read the license agreement then click "Yes".

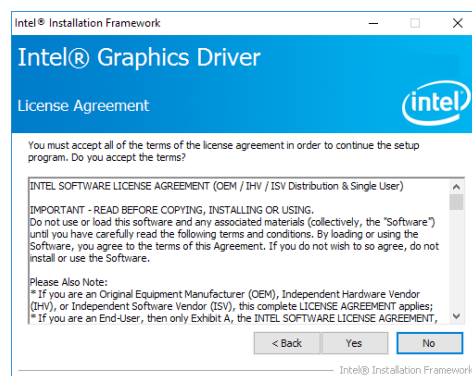

3. Go through the readme document for system requirements and installation tips then click "Next".

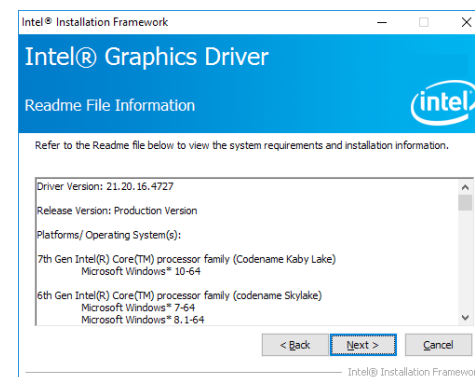

4. Setup is now installing the driver. Click "Next" to continue.

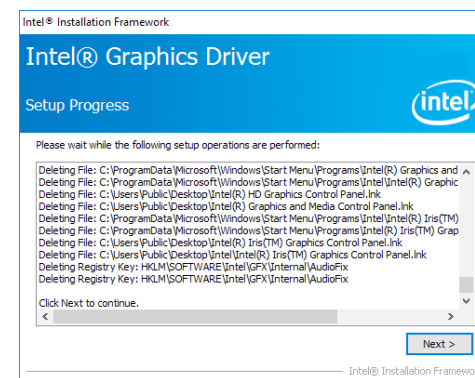

5. Click "Yes, I want to restart this computer now" then click "Finish".

Restarting the system will allow the new software installation to take effect.

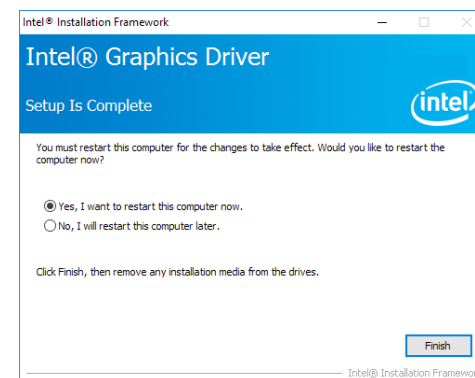

Audio Drivers

To install the driver, download "SD330 Audio Driver" zip file at our website.

1. Setup is ready to install the driver. Click "Next".

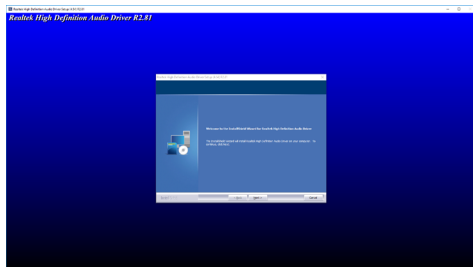

2. Click "Yes, I want to restart my computer now" then click "Finish".

Restarting the system will allow the new software installation to take effect.

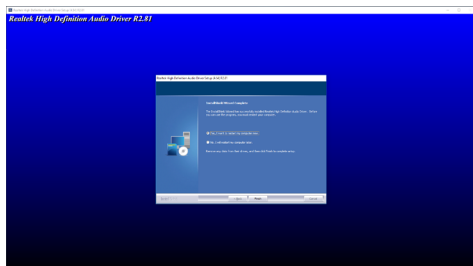

Intel LAN Drivers

To install the driver, download "SD330 LAN Driver" zip file at our website.

1. Setup is ready to install the driver. Click "Next".

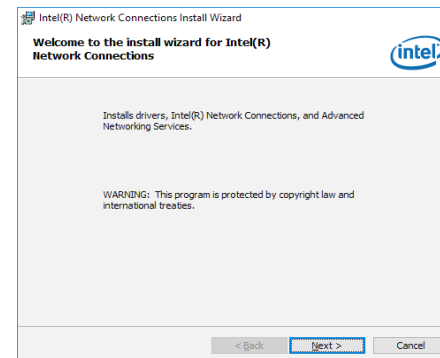

2. Click "I accept the terms in the license agreement" then click "Next".

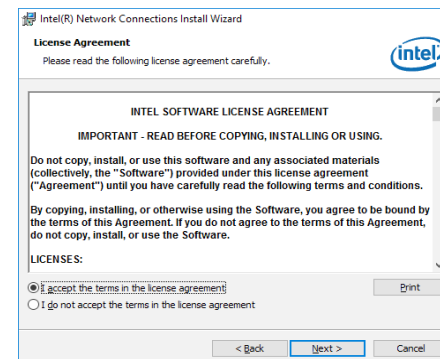

3. Select the program features you want installed then click "Next".

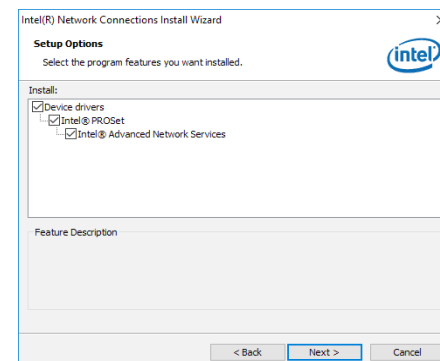

- Click "Install" to begin the installation.

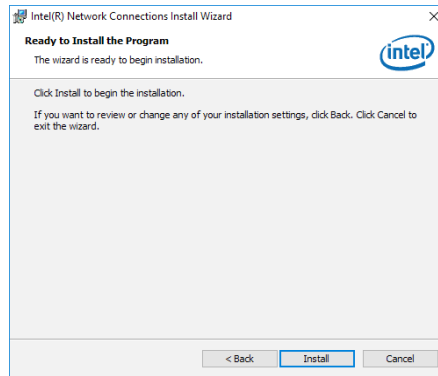

- The step displays the installing status in the progress.

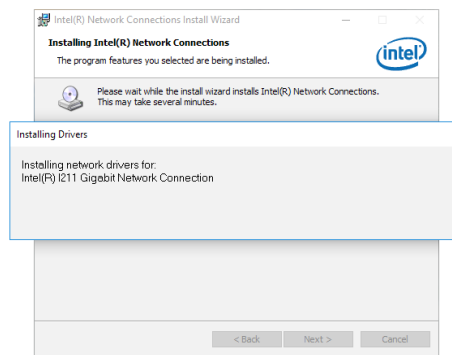

- After completing installation, click "Finish".

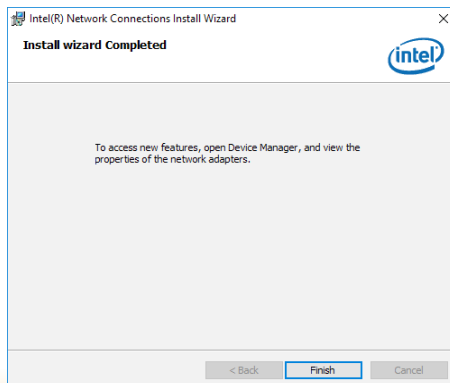

Kernel Mode Driver Framework (For Windows 7 only)

To install the driver, download "SD330 KMDF" zip file at our website.

- Click "Yes" to install the update.

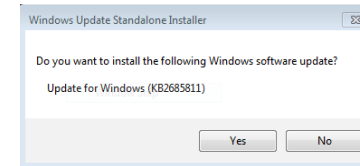

- The update is installed now.

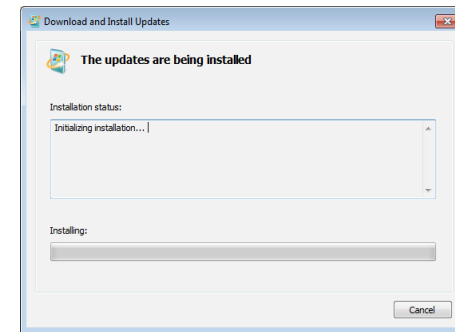

- Click "Restart Now" to restart your computer when the installation is complete.

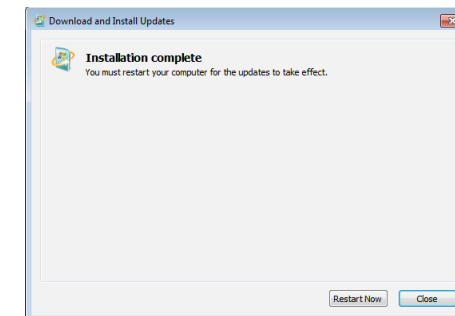

Intel Management Engine Interface Drivers

To install the driver, download "SD330 MEI Driver" zip file at our website.

1. Setup is ready to install the driver. Click "Next".

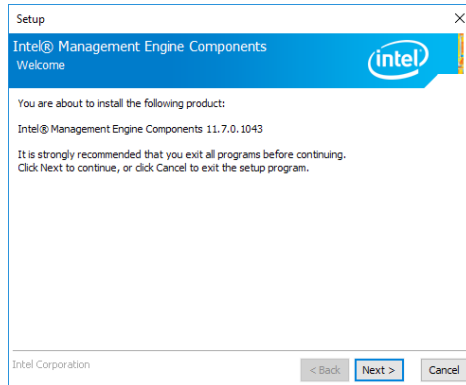

2. Read the license agreement then tick "I accept the terms in the License Agreement". Click "Next".

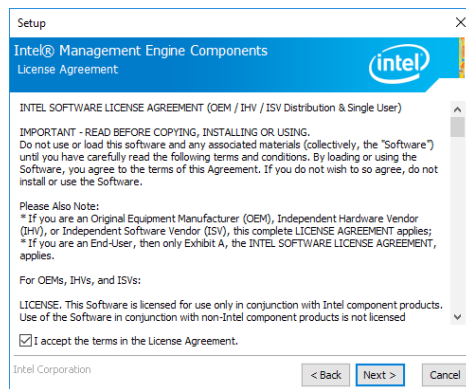

3. Click "Next" to install to the default folder, or click "Change" to choose another destination folder.

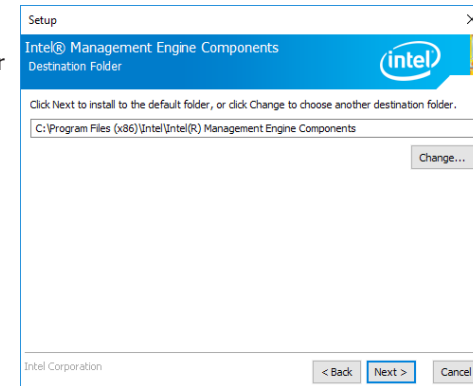

4. Please wait while the product is being installed.

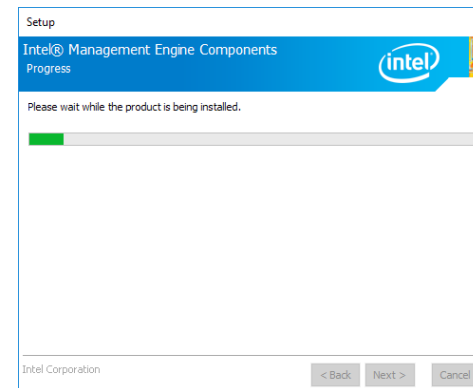

5. After completing installation, click "Finish".

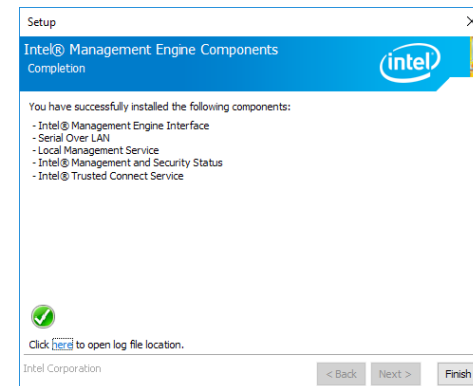

HW Utility

HW Utility provides information about the board, Watchdog and DIO. To access the utility, download "SD330 HW Utility" zip file at our website.



Note:

If you are using Windows 7, you need to access the operating system as an administrator to be able to install the utility.

1. Setup is ready to install the driver.

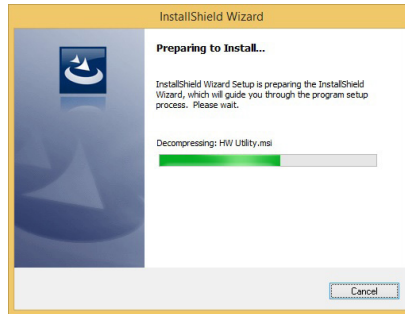

2. Click "Next" to continue.

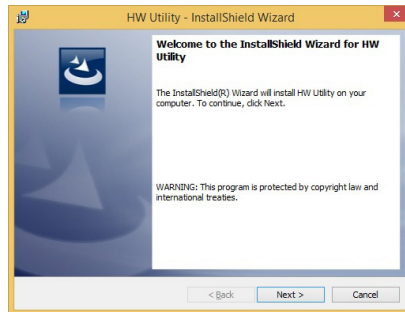

3. Read the license agreement then click "I accept the terms in the license agreement". Click "Next".

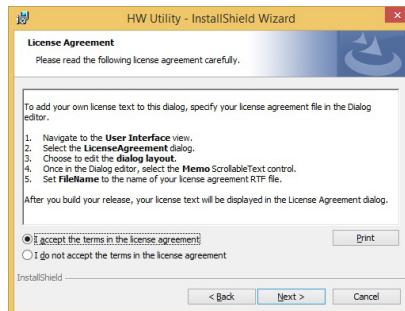

4. The wizard is ready to begin installation. Click "Install".

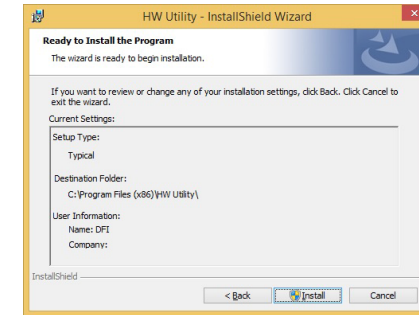

5. Please wait while the program features are being installed.

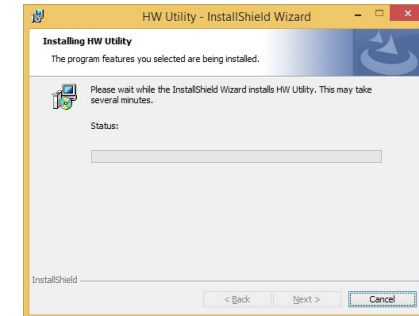

6. After completing installation, click "Finish".

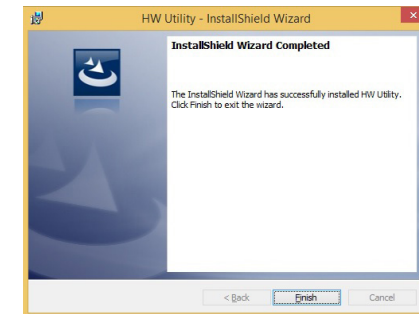

The HW Utility icon will appear on the desktop. Double-click the icon to open the utility.



Note:

Note: The screenshot displayed above is for illustrative purpose only, and may not resemble the actual screen.

The SD330-H110 HW Utility features the following tabs: Information, HW Health, HW Health-set, Watchdog, DIO and backlight. Click on the tabs to access information about the board.

Intel USB 3.0 Drivers (For Windows 7 and Windows 8.1)

To install the driver, download "SD330 USB3.0 Driver" zip file at our website.

1. Setup is ready to install the driver. Click "Next".

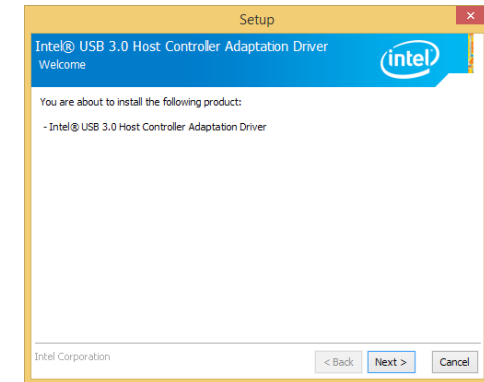

2. Read the license agreement then tick "I accept the terms in the license agreement". Click "Next".

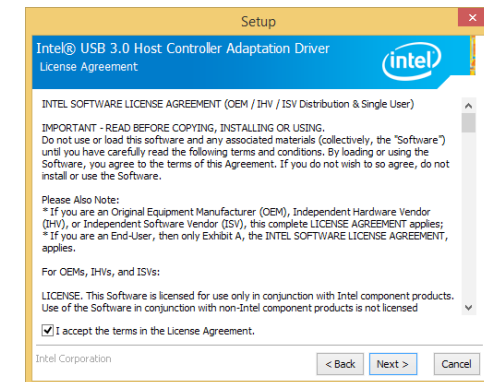

3. Click "Next".

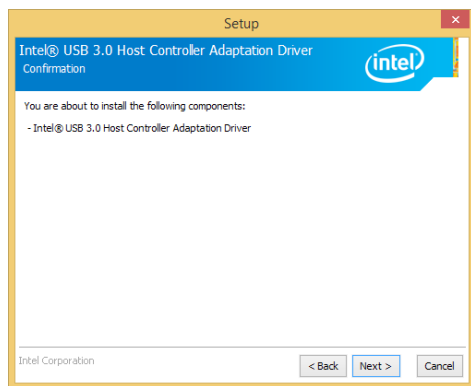

4. Setup is currently installing the driver. After installation has completed, click "Next".

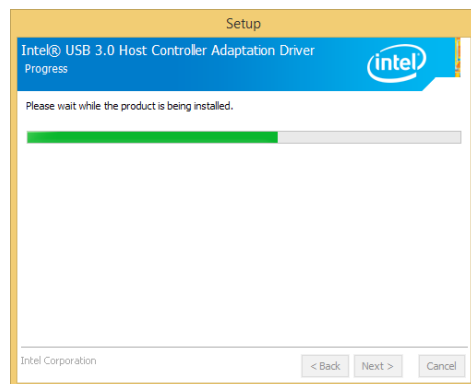

5. Click "Yes, I want to restart this computer now" then click "Finish".

Restarting the system will allow the new software installation to take effect.

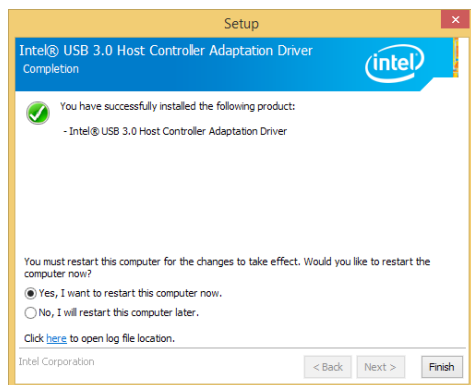

IO Driver

To install the driver, download "SD330 SIO Driver" zip file at our website.

1. Setup is ready to install the driver. Click "Next".

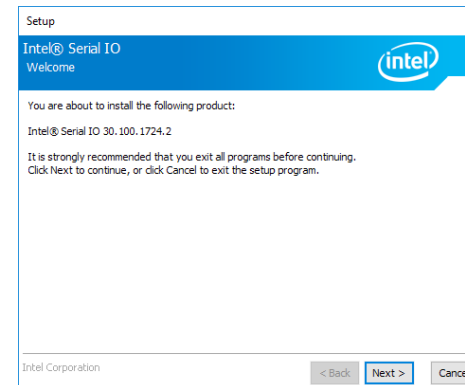

2. Read the license agreement carefully.

Tick "I accept the terms in the License Agreement" then click "Next".

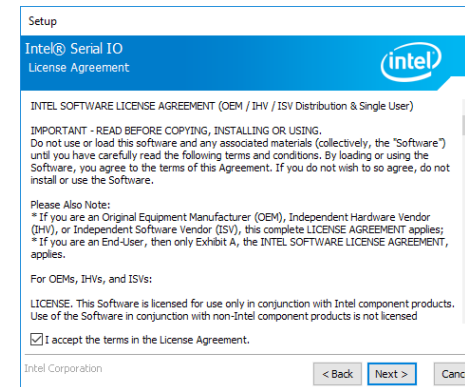

3. Go through the readme document for system requirements and installation tips then click "Next".

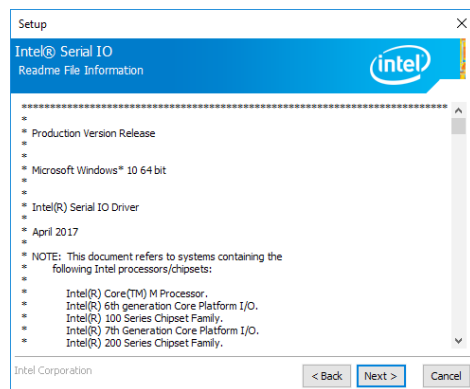

4. Setup is ready to install the driver. Click "Next".

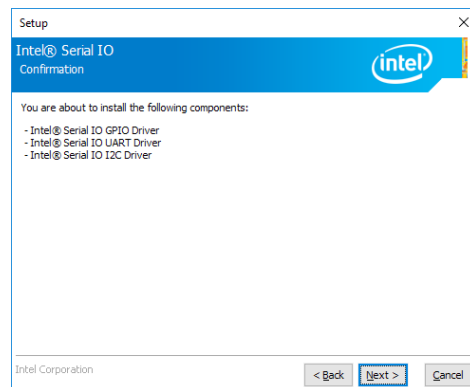

5. Setup is now installing the driver.

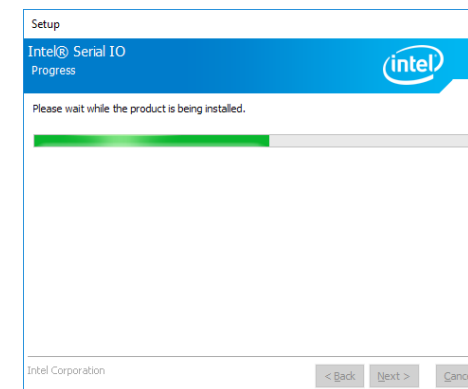

6. Click "Yes, I want to restart this computer now" then click "Finish".

Restarting the system will allow the new software installation to take effect.

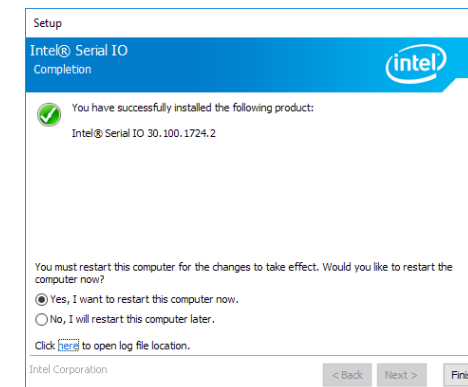

Microsoft Framework 4.5.2 (For Windows 7)



Note:

Before installing Microsoft Framework 4.5.2, make sure you have updated your Windows 7 operating system to Service Pack 3.

To install the driver, download "SD330 DotNetFx45" zip file at our website.

1. Setup is now extracting files.

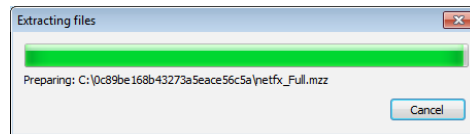

2. Read the license agreement carefully.

Click "I have read and accept the terms of the License Agreement" then click "Install".

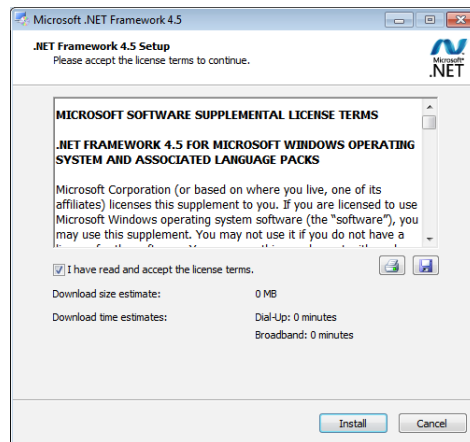

3. Setup is now installing the driver.

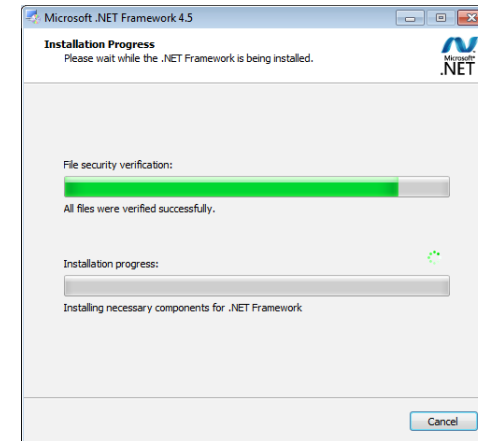

4. Click "Finish".

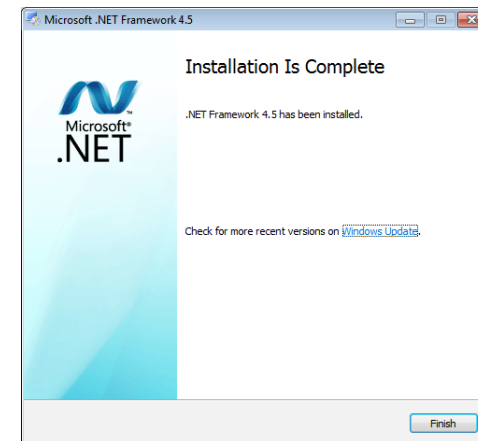

Infineon TPM 1.2 Driver and Tool (optional)

To install the driver, download "SD330 TPM1.2 Utility" zip file at our website.

1. The setup program is preparing to install the driver.

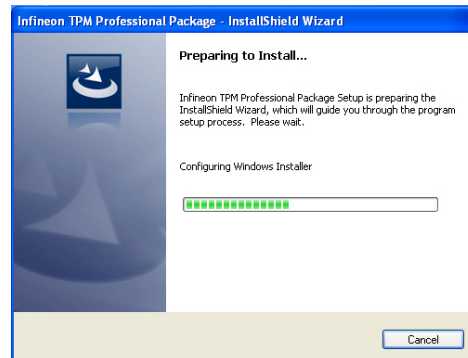

2. The setup program is now ready to install the utility. Click "Next".



3. Click "I accept the terms in the license agreement" and then click "Next".

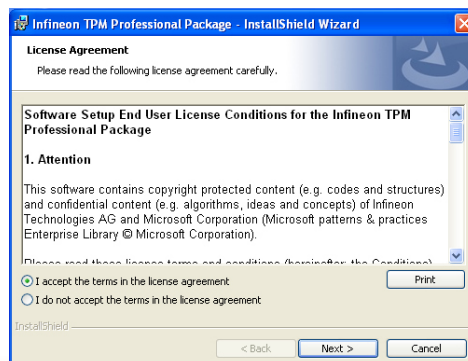

4. Enter the necessary information and then click "Next".

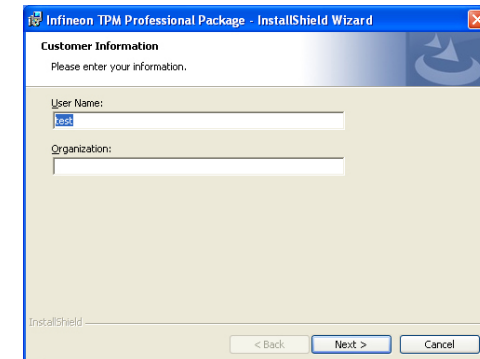

5. Select a setup type and then click "Next".

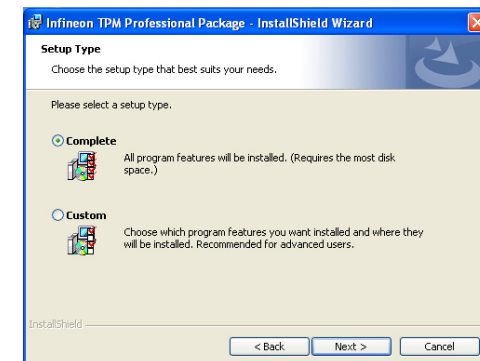

6. Click "Install".

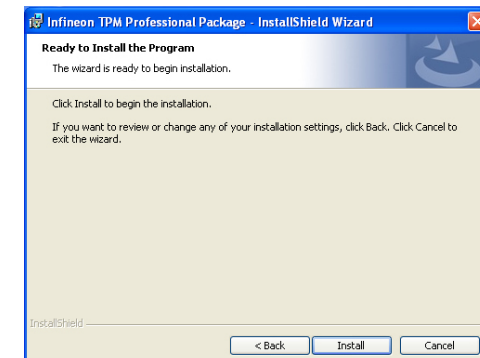

7. TPM requires installing the Microsoft Visual C++ package prior to installing the utility. Click "Install".

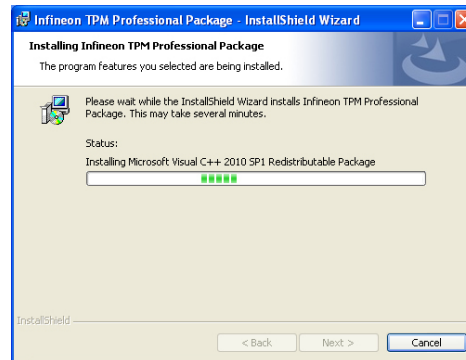

8. The setup program is currently installing the Microsoft Visual C++ package.

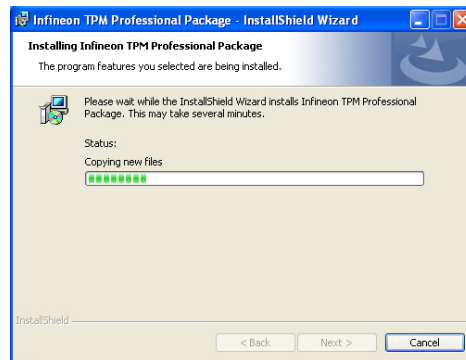

9. Click "Finish".



10. Click "Yes" to restart your system.

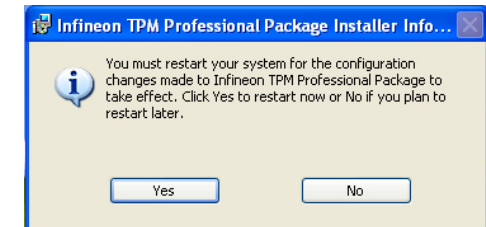

Infineon TPM 2.0 Driver and Tool (optional)

To install the driver, download "TPM2.0 Hotfix" zip file at our website.

1. Click "OK".

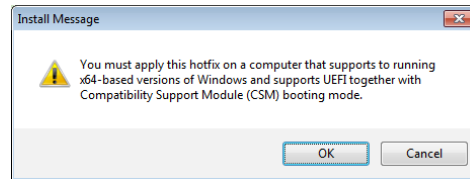

2. Click "Yes".

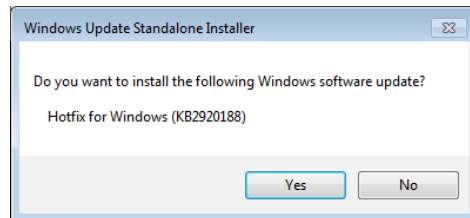

3. Setup is now installing the updates.

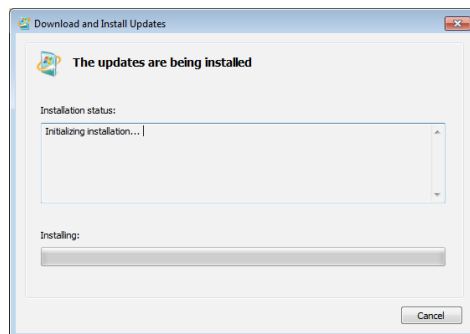

4. Click "Restart now" to restart your system.

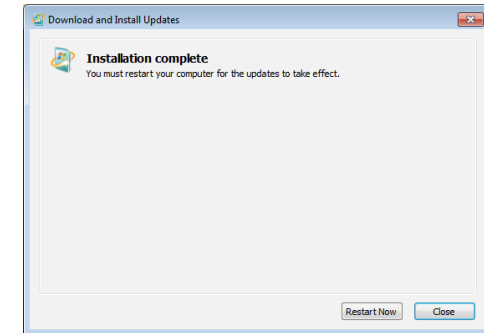

Adobe Acrobat Reader 9.3

To install the reader, download "SD330-H110 Driver Package" iso file at our website.

1. Click "Next" to install or click "Change Destination Folder" to select another folder.

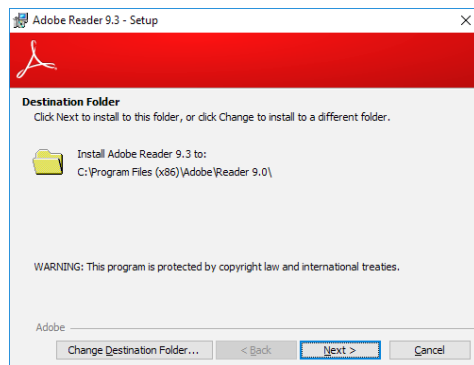

2. Click "Install" to begin installation.

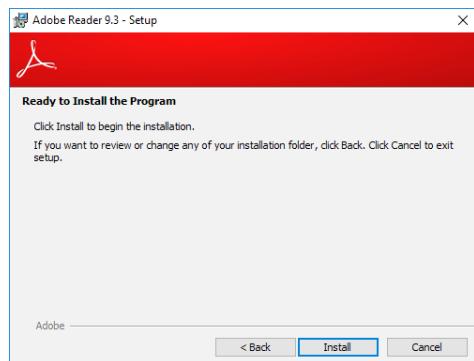

3. Setup is now installing the driver.

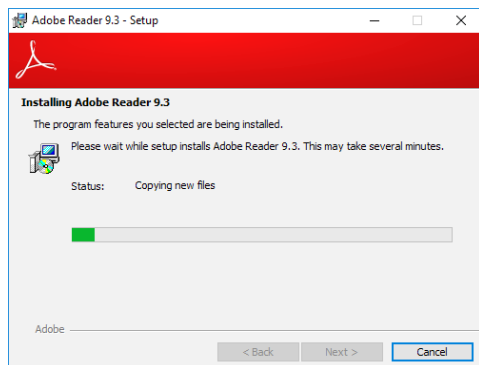

4. Click "Finish" to exit installation.

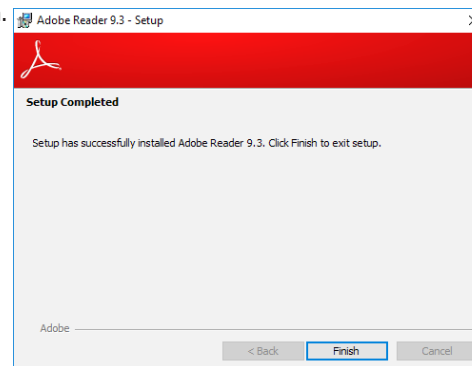

Appendix A - Troubleshooting Checklist

Troubleshooting Checklist

This chapter of the manual is designed to help you with problems that you may encounter with your personal computer. To efficiently troubleshoot your system, treat each problem individually. This is to ensure an accurate diagnosis of the problem in case a problem has multiple causes.

Some of the most common things to check when you encounter problems while using your system are listed below.

1. The power switch of each peripheral device is turned on.
2. All cables and power cords are tightly connected.
3. The electrical outlet to which your peripheral devices connected is working. Test the outlet by plugging in a lamp or other electrical device.
4. The monitor is turned on.
5. The display's brightness and contrast controls are adjusted properly.
6. All add-in boards in the expansion slots are seated securely.
7. Any add-in board you have installed is designed for your system and is set up correctly.

Monitor/Display

If the display screen remains dark after the system is turned on:

1. Make sure that the monitor's power switch is on.
2. Check that one end of the monitor's power cord is properly attached to the monitor and the other end is plugged into a working AC outlet. If necessary, try another outlet.
3. Check that the video input cable is properly attached to the monitor and the system's display adapter.
4. Adjust the brightness of the display by turning the monitor's brightness control knob.

The picture seems to be constantly moving.

1. The monitor has lost its vertical sync. Adjust the monitor's vertical sync.
2. Move away any objects, such as another monitor or fan, that may be creating a magnetic field around the display.
3. Make sure your video card's output frequencies are supported by this monitor.

The screen seems to be constantly wavering.

1. If the monitor is close to another monitor, the adjacent monitor may need to be turned off. Fluorescent lights adjacent to the monitor may also cause screen wavering.

Power Supply

When the computer is turned on, nothing happens.

1. Check that one end of the AC power cord is plugged into a live outlet and the other end properly plugged into the back of the system.
2. Make sure that the voltage selection switch on the back panel is set for the correct type of voltage you are using.
3. The power cord may have a "short" or "open". Inspect the cord and install a new one if necessary.

Hard Drive

Hard disk failure.

1. Make sure the correct drive type for the hard disk drive has been entered in the BIOS.
2. If the system is configured with two hard drives, make sure the bootable (first) hard drive is configured as Master and the second hard drive is configured as Slave. The master hard drive must have an active/bootable partition.

Excessively long formatting period.

If your hard drive takes an excessively long period of time to format, it is likely a cable connection problem. However, if your hard drive has a large capacity, it will take a longer time to format.

Serial Port

The serial device (modem, printer) doesn't output anything or is outputting garbled characters.

1. Make sure that the serial device's power is turned on and that the device is on-line.
2. Verify that the device is plugged into the correct serial port on the rear of the computer.
3. Verify that the attached serial device works by attaching it to a serial port that is working and configured correctly. If the serial device does not work, either the cable or the serial device has a problem. If the serial device works, the problem may be due to the onboard I/O or the address setting.
4. Make sure the COM settings and I/O address are configured correctly.

Keyboard

Nothing happens when a key on the keyboard was pressed.

1. Make sure the keyboard is properly connected.
2. Make sure there are no objects resting on the keyboard and that no keys are pressed during the booting process.

System Board

1. Make sure the add-in card is seated securely in the expansion slot. If the add-in card is loose, power off the system, re-install the card and power up the system.
2. Check the jumper settings to ensure that the jumpers are properly set.
3. Verify that all memory modules are seated securely into the memory sockets.
4. Make sure the memory modules are in the correct locations.
5. If the board fails to function, place the board on a flat surface and seat all socketed components. Gently press each component into the socket.
6. If you made changes to the BIOS settings, re-enter setup and load the BIOS defaults.