



## ES220F-CS

Compact Fanless Embedded System  
User's Manual

## Copyright

This publication contains information that is protected by copyright. No part of it may be reproduced in any form or by any means or used to make any transformation/adaptation without the prior written permission from the copyright holders.

This publication is provided for informational purposes only. The manufacturer makes no representations or warranties with respect to the contents or use of this manual and specifically disclaims any express or implied warranties of merchantability or fitness for any particular purpose. The user will assume the entire risk of the use or the results of the use of this document. Further, the manufacturer reserves the right to revise this publication and make changes to its contents at any time, without obligation to notify any person or entity of such revisions or changes.

Changes after the publication's first release will be based on the product's revision. The website will always provide the most updated information.

© 2023. All Rights Reserved.

## Trademarks

Product names or trademarks appearing in this manual are for identification purpose only and are the properties of the respective owners.

## FCC and DOC Statement on Class A

This equipment has been tested and found to comply with the limits for a Class A digital device, pursuant to Part 15 of the FCC rules. These limits are designed to provide reasonable protection against harmful interference when the equipment is operated in a residential installation. This equipment generates, uses and can radiate radio frequency energy and, if not installed and used in accordance with the instruction manual, may cause harmful interference to radio communications. However, there is no guarantee that interference will not occur in a particular installation. If this equipment does cause harmful interference to radio or television reception, which can be determined by turning the equipment off and on, the user is encouraged to try to correct the interference by one or more of the following measures:

- Reorient or relocate the receiving antenna.
- Increase the separation between the equipment and the receiver.
- Connect the equipment into an outlet on a circuit different from that to which the receiver is connected.
- Consult the dealer or an experienced radio TV technician for help.

## Notice:

1. The changes or modifications not expressly approved by the party responsible for compliance could void the user's authority to operate the equipment.
2. Shielded interface cables must be used in order to comply with the emission limits.

# Table of Contents

Chapter 1 - Introduction.....	6
Overview- 1 Storage.....	6
Front View.....	6
Rear View.....	6
Chapter 1 - Introduction.....	7
Overview- 3 Storage.....	7
Front View.....	7
Rear View.....	7
Dimensions.....	8
1 Storage.....	8
3 Storage.....	8
Key Features.....	8
Specifications.....	9
Chapter 2 - Hardware Installations.....	11
Removing the Chassis Cover.....	11
Installing an M.2 Card.....	12
Installing an Antenna.....	13
Mounting Options.....	14
Wall Mount.....	14
VESA Mount.....	15
Chapter 4 - BIOS Settings.....	16
Overview.....	16
Main.....	17
Advanced.....	17
RC ACPI Configuration.....	18
CPU Configuration.....	18
Power & Performance.....	19
PCH-FW Configuration.....	19
Trusted Computing.....	20
NCT5525D Super IO Configuration.....	20
NCT5525D Super IO Configuration ▶ Serial Port 1, 2 Configuration.....	21
NCT5525D HW Monitor.....	21
USB Configuration.....	22
CSM Configuration.....	22
USB Power Control.....	23
Network Stack Configuration.....	23
Chipset.....	24
Graphics Configuration.....	24
PCH-IO Configuration.....	25
PCH-IO Configuration ▶ PCI Express Configuration.....	26
PCH-IO Configuration ▶ SATA And RST Configuration.....	26
PCH-IO Configuration ▶ HD Audio Configuration.....	27
Security.....	28
Secure Boot.....	28
Boot.....	29
Save & Exit.....	29
Updating the BIOS.....	30
Notice: BIOS SPI ROM.....	30

## About this Manual

This manual can be retrieved from the website.

The manual is subject to change and update without notice, and may be based on editions that do not resemble your actual products. Please visit our website or contact our sales representatives for the latest editions.

## Warranty

1. Warranty does not cover damages or failures that arises from misuse of the product, inability to use the product, unauthorized replacement or alteration of components and product specifications.
2. The warranty is void if the product has been subjected to physical abuse, improper installation, modification, accidents or unauthorized repair of the product.
3. Unless otherwise instructed in this user's manual, the user may not, under any circumstances, attempt to perform service, adjustments or repairs on the product, whether in or out of warranty. It must be returned to the purchase point, factory or authorized service agency for all such work.
4. We will not be liable for any indirect, special, incidental or consequential damages to the product that has been modified or altered.

## About this Package

The package contains the following items. If any of these items are missing or damaged, please contact your dealer or sales representative for assistance.

- 1 ES220F-CS system unit with wallmount
- Adapter 12V 60W (optional)
- Power Cord 1830mm (optional)
- VESA mounting kit (optional)

Note: The items are subject to change in the developing stage. The product and accessories in the package may not come similar to the information listed above. This may differ in accordance with the sales region or models in which it was sold. For more information about the standard package in your region, please contact your dealer or sales representative.

## Static Electricity Precautions

It is quite easy to inadvertently damage your PC, system board, components or devices even before installing them in your system unit. Static electrical discharge can damage computer components without causing any signs of physical damage. You must take extra care in handling them to ensure against electrostatic build-up.

1. To prevent electrostatic build-up, leave the system board in its anti-static bag until you are ready to install it.
2. Wear an antistatic wrist strap.
3. Do all preparation work on a static-free surface.
4. Hold the device only by its edges. Be careful not to touch any of the components, contacts or connections.
5. Avoid touching the pins or contacts on all modules and connectors. Hold modules or connectors by their ends.



### Important:

Electrostatic discharge (ESD) can damage your processor, disk drive and other components. Perform the upgrade instruction procedures described at an ESD workstation only. If such a station is not available, you can provide some ESD protection by wearing an antistatic wrist strap and attaching it to a metal part of the system chassis. If a wrist strap is unavailable, establish and maintain contact with the system chassis throughout any procedures requiring ESD protection.

## Safety Precautions

- Use the correct DC / AC input voltage range.
- Unplug the power cord before removing the system chassis cover for installation or servicing. After installation or servicing, cover the system chassis before plugging in the power cord.
- There is danger of explosion if battery incorrectly replaced.
- Replace only with the same or equivalent specifications of batteries recommend by the manufacturer.
- Dispose of used batteries according to local ordinance.
- Keep this system away from humid environments.
- Make sure the system is placed or mounted correctly and stably to prevent the chance of dropping or falling may cause damage.
- The openings on the system shall not be blocked and shall be kept in distance from

other objects to make sure of proper air ventilation to protect the system from over-heating.

- Dress the cables, especially the power cord, so they will not be stepped on, in contact with high temperature surfaces, or cause any tripping hazards.
- Do not place anything on top of the power cord. Use a power cord that has been approved for use with the system and is compliant with the voltage and current ranges required by the system's electrical specifications.
- If the system is to be unused or stored for a long time, disconnect it from the power source to avoid damage by transient overvoltage.
- If one of the following occurs, consult a service personnel:
  - The power cord or plug is damaged.
  - Liquid has penetrated the system.
  - The system has been exposed to moisture.
  - The system is not working properly.
  - The system is physically damaged.
- The unit uses a three-wire ground cable which is equipped with a third pin to ground the unit and prevent electric shock. Do not defeat the purpose of this pin. If your outlet does not support this kind of plug, contact your electrician to replace the outlet.
- Disconnect the system from the electricity outlet before cleaning. Use a damp cloth for cleaning the surface. Do not use liquid or spray detergents for cleaning.
- Before connecting, make sure that the power supply voltage is correct. The device is connected to a power outlet which should be grounded connection.



The system may burn fingers while running.

Wait for 30 minutes to handle electronic parts after power off.

## Chapter 1 - Introduction

### ► Overview- 1 Storage

Front View

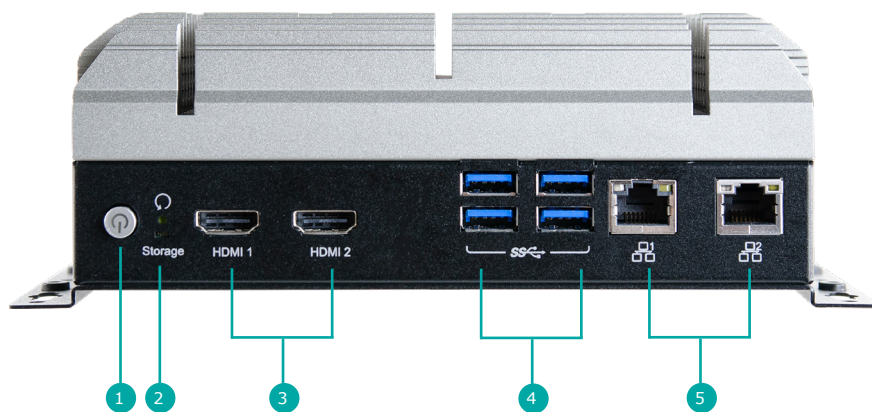

- 1 Power Button
- 2 Status LED, Reset Button
- 3 HDMI 2.0
- 4 USB 3.1
- 5 LAN 1 & LAN 2

Rear View

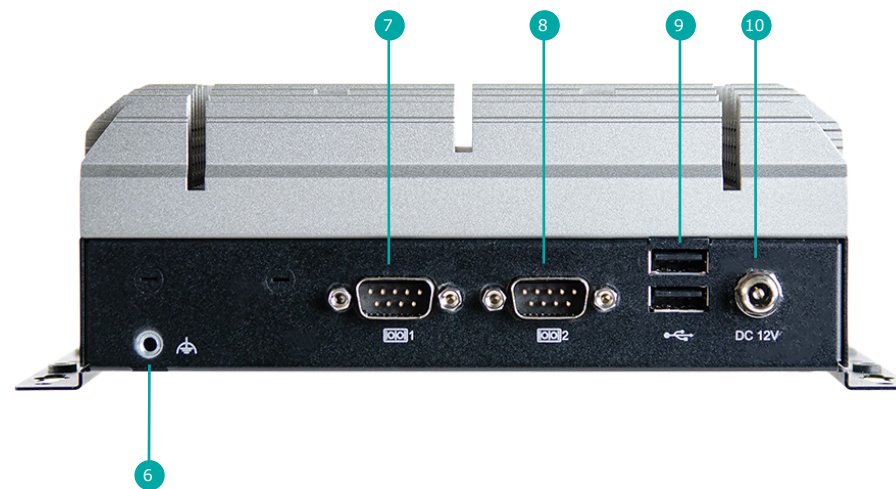

- 6 Grounding Hole
- 7 COM 1
- 8 COM 2
- 9 USB 2.0
- 10 DC-in



## Chapter 1 - Introduction

### ► Overview- 3 Storage

Front View

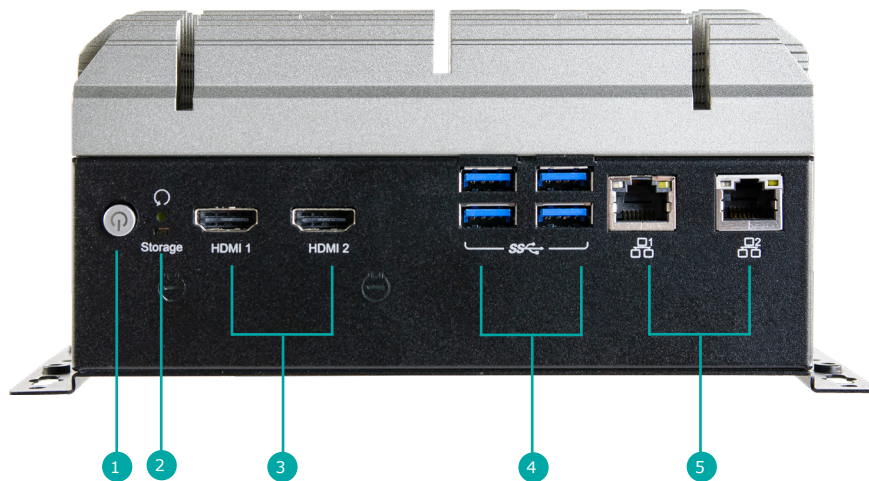

- 1 Power Button
- 2 Status LED, Reset Button
- 3 HDMI 2.0
- 4 USB 3.1
- 5 LAN 1 & LAN 2

Rear View



- 6 Grounding Hole
- 7 COM 1
- 8 COM 2
- 9 USB 2.0
- 10 DC-in

► Dimensions

1 Storage

1 Storage (1x m.2 SSD)

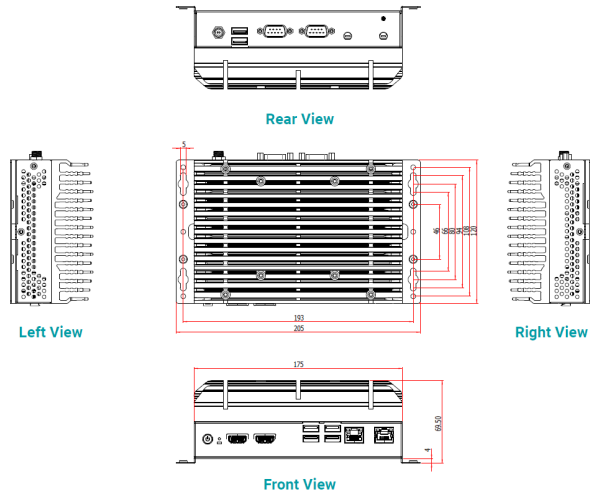

3 Storage

3 Storage (1x m.2 SSD + 2x 2.5" SSD)

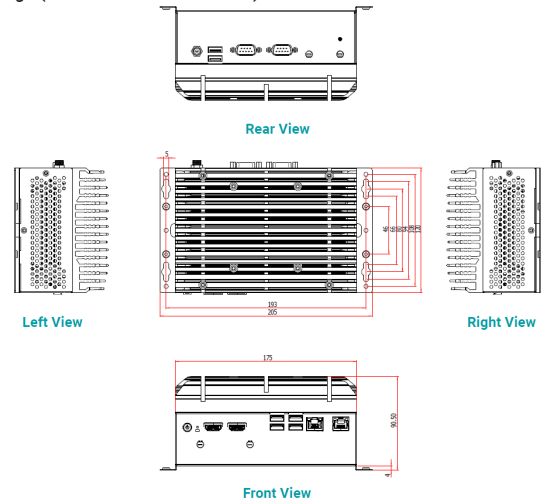

► Key Features

Two HDMI 2.0:

2 x HDMI 2.0 Supports 4K@60Hz resolution

Triple Storage:

1 x M.2 SSD + 2 x 2.5" SSD (optional)

DDR4:

2 x DDR4 SODIMM up to 64GB

RAID Support:

RAID support NAS/Server application

Rich I/O:

2 x Intel GbE, 4 x USB 3.1, 2 x USB 2.0, 2 x COM



► Specifications

<b>SYSTEM</b>	<b>Processor</b>	9th Gen Intel® Core™ Processors, LGA 1151 Socket Intel® Core™ i7-9700TE Processor (8C/8T, 12M Cache, 3.6GHz, TDP 35W) Intel® Core™ i5-9500TE Processor (6C/6T, 9M Cache, 3.6GHz, TDP 35W) Intel® Core™ i3-9100TE Processor (4C/4T, 6M Cache, 3.2GHz, TDP 35W)
		8th Gen Intel® Core™ Processors, LGA 1151 Socket Intel® Core™ i7-8700T Processor (6C/12T, 12M Cache, 4.0GHz; TDP 35W) Intel® Core™ i5-8500T Processor (6C/6T, 9M Cache, 3.5GHz; TDP 35W) Intel® Core™ i3-8100T Processor (4C/4T, 6M Cache, 3.1GHz; TDP 35W) Intel® Pentium® G5400T Processor (2C/4T, 4M Cache, 3.1GHz; TDP 35W) Intel® Celeron® G4900T Processor (2C/2T, 2M Cache, 2.9GHz; TDP 35W)
	<b>Chipset</b>	Intel® C246/Q370/H310 Chipset
	<b>Memory</b>	2 x 260-pin SODIMM up to 64GB Dual Channel DDR4 2666MHz (ECC : C246 only)
	<b>BIOS</b>	AMI SPI 128Mbit
<b>GRAPHICS</b>	<b>Controller</b>	Intel® HD Graphics
	<b>Feature</b>	OpenGL 4.5, DirectX 12, OpenCL 2.1 HW Decode: AVC/H.264, MPEG2, VC1/WMV9, JPEG/MJPEG, HEVC/H265, VP8, VP9 HW Encode: AVC/H.264, MPEG2, JPEG, HEVC/H265, VP8, VP9
	<b>Display</b>	2 x HDMI 2.0 HDMI: resolution up to 4096x2160@60Hz
	<b>Dual Displays</b>	2 x HDMI 2.0
<b>STORAGE</b>	<b>Internal</b>	2 x 2.5" SATA bay (optional) Support RAID 0/1
<b>EXPANSION</b>	<b>Interface</b>	1 x M.2 2280 M key (PCIe x4/SATA 3.0) 1 x M.2 2230 E key (PCIe x1/USB2.0), WiFi
<b>ETHERNET</b>	<b>Interface</b>	2 x GbE RJ-45
	<b>Controller</b>	2 x Intel® I219/I210IT (10/100/1000Mbps) (Support Intel® iAMT)
<b>LED</b>	<b>Indicators</b>	1 x PWD LED 1 x HDD LED

<b>FRONT I/O</b>	Ethernet	2 x GbE (RJ-45)
	USB	4 x USB 3.1 (type A)
	Buttons	1 x Power button 1 x Reset button
	Display	2 x HDMI 2.0
<b>REAR I/O</b>	Serial	2 x RS232/RS422/RS485 (DB9) or 1 x RS232/RS422/RS485 (DB9)(COM1) + 1 x 8bit DIO (DB9)
	USB	2 x USB 2.0 (type A)
	Antenna	2 x Opening Antenna Hole (WiFi)
<b>WATCHDOG TIMER</b>	Output & Interval	Watchdog timeout programmable via software from 1 to 255 seconds
<b>SECURITY</b>	TPM	TPM2.0 (optional)
<b>POWER</b>	Type	12V DC-in jack lockable External power brick
	RTC Battery	CR2032 Coin Cell
	Supply	AC Power 100-250V, 50/60Hz
<b>OS SUPPORT</b>	Microsoft	Windows 10 IoT Enterprise 2019 LTSC + RS5 Windows 10 Professional
<b>MECHANISM</b>	Construction	Metal + Aluminum
	Mounting	Wall mount VESA mount 75x75/10x10cm (optional)
	Dimensions (W x H x D)	175 x 69.4 x 120mm (1 Storage: 1 x M.2 SSD) 175 x 90.4 x 120mm (3 Storage: 1 x M.2 SSD + 2 x 2.5" bay)
	Weight	3.5kg (1 Storage: 1 x M.2 SSD) 3.8kg (3 Storage: 1 x M.2 SSD + 2 x 2.5" bay)
	Cooler	Black
	<b>ENVIRONMENT</b>	Operating Temperature
Storage Temperature		-20° to 60° C
Relative Humidity		5 to 90% RH
<b>STANDARDS AND CERTIFICATIONS</b>	Certifications	FCC, CE Class B, RoHS, WEEE, UKCA

## Chapter 2 - Hardware Installations

### ► Removing the Chassis Cover

Please observe the following guidelines and follow the instructions to open the system.

1. Make sure the system and all other peripheral devices connected to it have been powered off.
2. Disconnect all power cords and cables.

#### Step 1:

**To remove the top cover** - The 8 screws on the top of the system are used to secure the cover to the chassis. Remove the screws and put them in a safe place for later use. And then lift up the cover to remove it.

**To remove the bottom cover** - The 2 screws on the bottom of the system are used to secure the cover to the chassis. Remove the screws and put them in a safe place for later use. And then tilt up the cover to remove it.

Top View



Bottom View



#### Step 2:

Lift the cover to open the system.



#### Step 3:

The board can be easily accessed after the chassis cover is removed.

Top View

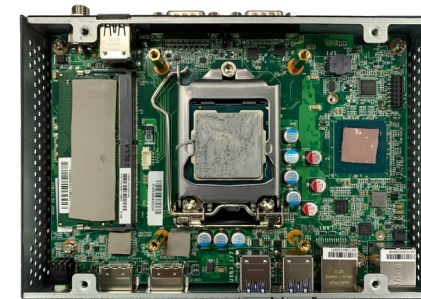

Bottom View



## ► Installing an M.2 Card

Please observe the following guidelines and follow the instructions to open the system.

1. Make sure the system and all other peripheral devices connected to it have been powered off.
2. Disconnect all power cords and cables.

### Step 1:

The 2 screws on the bottom of the system are used to secure the cover to the chassis. Remove the screws and put them in a safe place for later use. Lift the cover to open the system. M.2 card slots can be easily accessed after the chassis cover is removed.

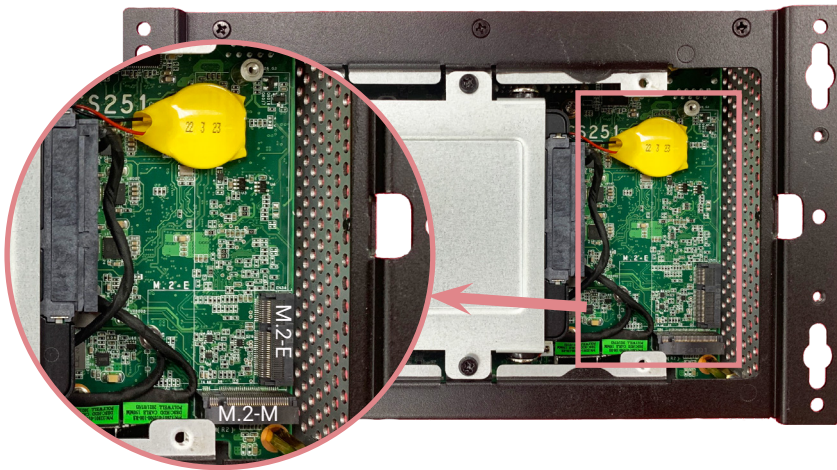

### Step 2:

Please follow the steps below to install the card into the socket. Insert the card into the socket at an angle while making sure the notch and key are perfectly aligned.

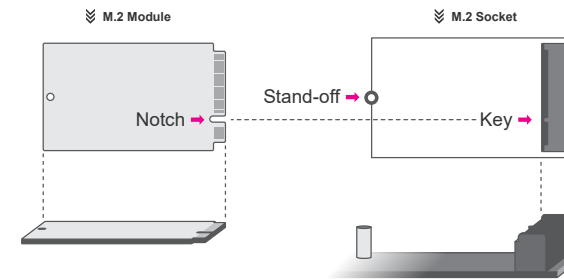

### Step 3:

Press the end of the card far from the socket down until against the stand-off.

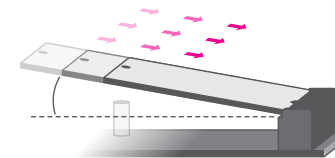

### Step 4:

Screw tight the card onto the stand-off with a screw driver and a stand-off screw until the gap between the card and the stand-off closes up. The card should be lying parallel to the board when it's correctly mounted.

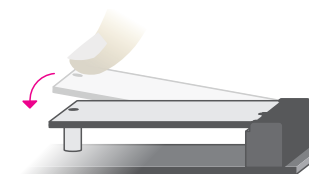

### ► Installing an Antenna

Before installing the antenna, please make sure that the following safety cautions are wellattended.

1. Make sure the PC and all other peripheral devices connected to it have been powered down.
2. Disconnect all power cords and cables.

#### Step 1:

There are antenna holes reserved on the front and back side of the system and covered by 4 knockout tabs. Please remove the knockout tabs prior to installing an antenna.



#### Step 2:

Use a flathead screwdriver and apply a little extra force to detach a knockout tab until it breaks off from the system. Once the knockout tab is mostly detached, it will pretty quickly snap off, leaving you a nice hole for installing an antenna.

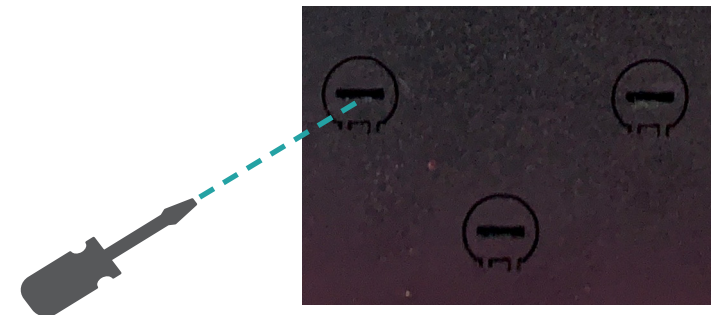

#### Step 3:

Connect the internal cable to the board's antenna connector, screw the antenna connector through the antenna hole with washers and nuts, and screw on the antenna as illustrated below.

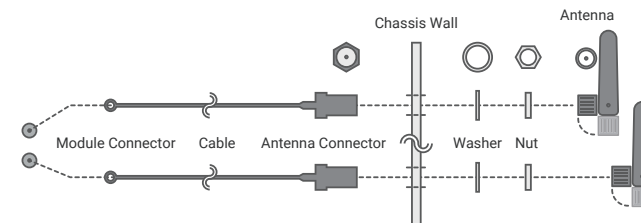

► Mounting Options

Wall Mount

The wall mount kit containing two mounting brackets – purchased as optional items – can be attached to the bottom of the system for mounting onto desired locations, such as walls, stands, or shelves. Locate the mounting holes on the bottom of the system as shown in the photo. Screw on the two brackets onto the system with four screws as illustrated below.

1 storage

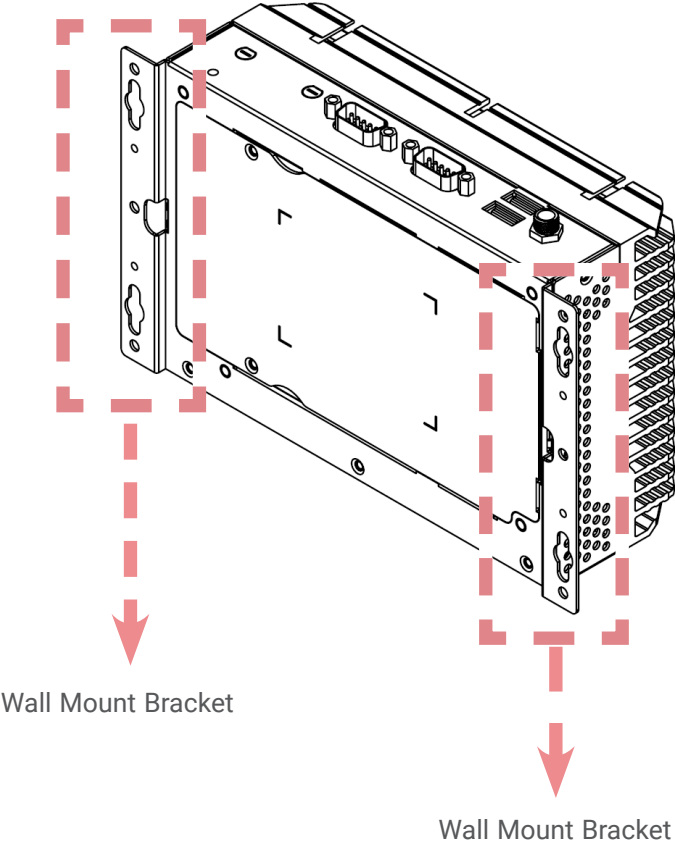

3 storage

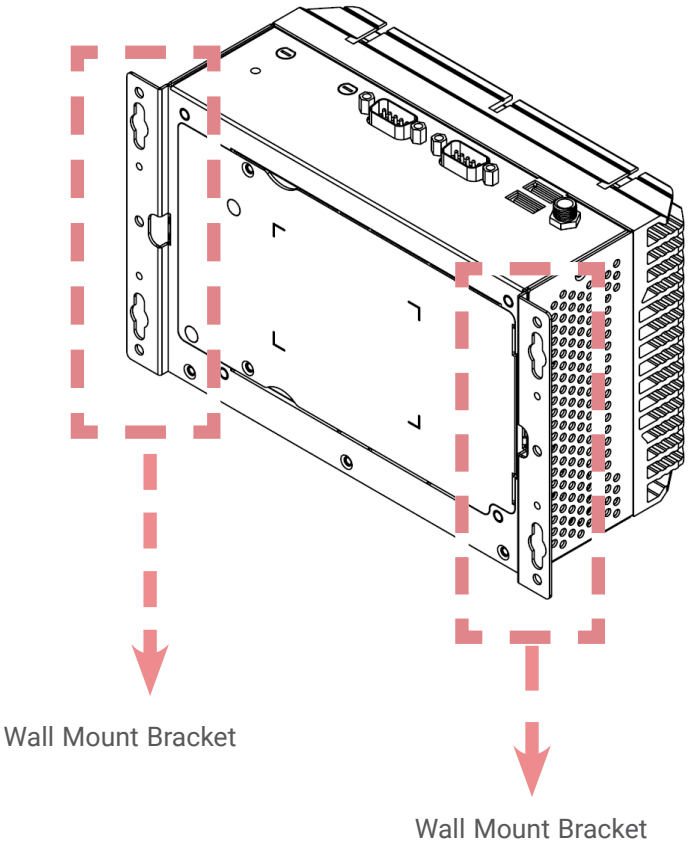



### VESA Mount

The VESA mount bracket has two sets of pre-drilled mounting holes – 75mm x 75mm, 100mm x 100mm – to adapt to mounting variants. Mount the bracket onto the tapped holes on the back of a monitor, a stand or a wall rack. If equipment installed on monitor by VESA mount, the weight for monitor should under 6.1kg

1 storage

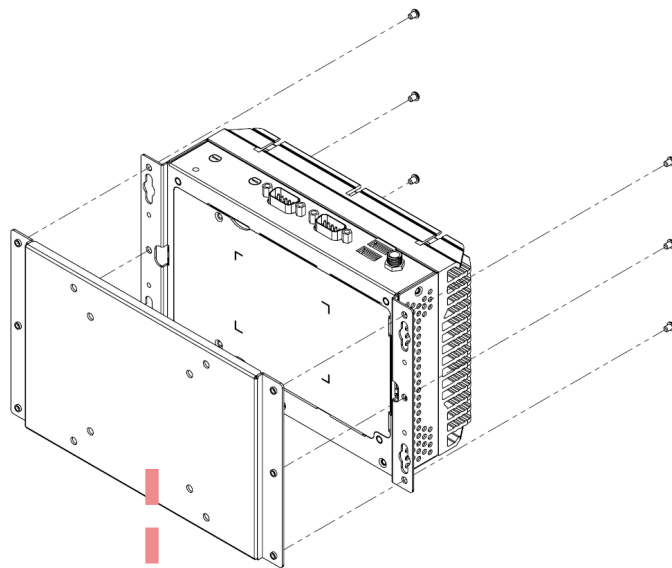

VESA Mount Bracket

3 storage

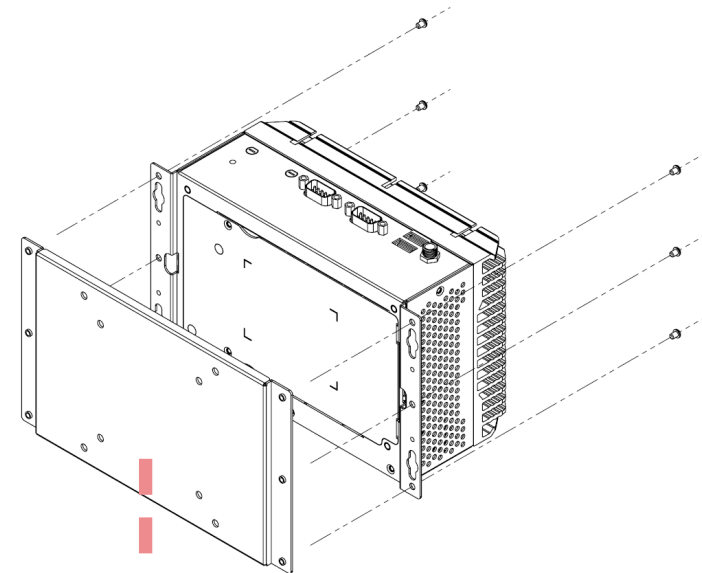

VESA Mount Bracket

## Chapter 4 - BIOS Settings

### ► Overview

The BIOS is a program that takes care of the basic level of communication between the CPU and peripherals. It contains codes for various advanced features found in this system board. The BIOS allows you to configure the system and save the configuration in a battery-backed CMOS so that the data retains even when the power is off. In general, the information stored in the CMOS RAM of the EEPROM will stay unchanged unless a configuration change has been made such as a hard drive replaced or a device added.

It is possible that the CMOS battery will fail causing CMOS data loss. If this happens, you need to install a new CMOS battery and reconfigure the BIOS settings.



#### Note:

The BIOS is constantly updated to improve the performance of the system board; therefore the BIOS screens in this chapter may not appear the same as the actual one. These screens are for reference purpose only.

#### Default Configuration

Most of the configuration settings are either predefined according to the Load Optimal Defaults settings which are stored in the BIOS or are automatically detected and configured without requiring any actions. There are a few settings that you may need to change depending on your system configuration.

#### Entering the BIOS Setup Utility

The BIOS Setup Utility can only be operated from the keyboard and all commands are keyboard commands. The commands are available at the right side of each setup screen.

The BIOS Setup Utility does not require an operating system to run. After you power up the system, the BIOS message appears on the screen and the memory count begins. After the memory test, the message "Press DEL to run setup" will appear on the screen. If the message disappears before you respond, restart the system or press the "Reset" button. You may also restart the system by pressing the <Ctrl> <Alt> and <Del> keys simultaneously.

#### Legends

Keys	Function
Right / Left arrow	Move the highlight left or right to select a menu
Up / Down arrow	Move the highlight up or down between submenus or fields
<Enter>	Enter the highlighted submenu
+ (plus key)/F6	Scroll forward through the values or options of the highlighted field
- (minus key)/F5	Scroll backward through the values or options of the highlighted field
<F1>	Display general help
<F2>	Display previous values
<F7>	Popup Boot Device List
<F9>	Optimized defaults
<F10>	Save and Exit
<Esc>	Return to previous menu

#### Scroll Bar

When a scroll bar appears to the right of the setup screen, it indicates that there are more available fields not shown on the screen. Use the up and down arrow keys to scroll through all the available fields.

#### Submenu

When "►" appears on the left of a particular field, it indicates that a submenu which contains additional options are available for that field. To display the submenu, move the highlight to that field and press <Enter>.

► Main

The Main menu is the first screen that you will see when you enter the BIOS Setup Utility.

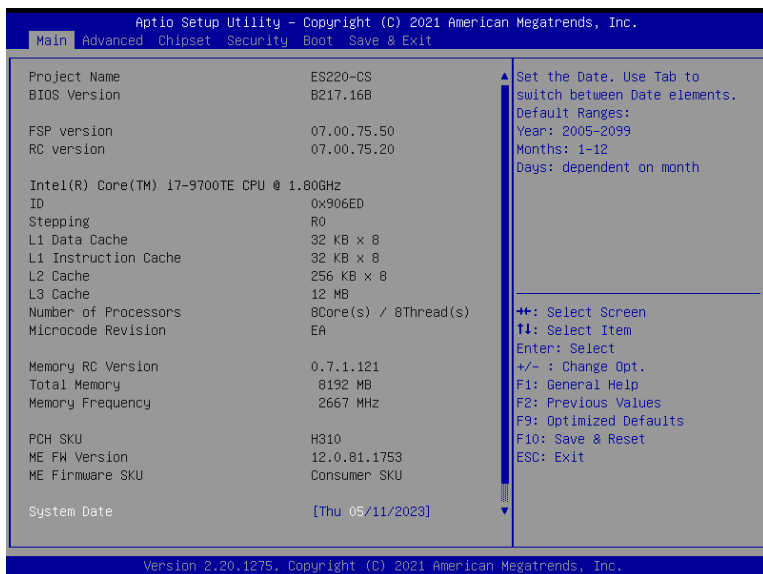

**System Date**

The date format is <month>, <date>, <year>. Press "Tab" to switch to the next field and press "-" or "+" to modify the value.

**System Time**

The time format is <hour>, <minute>, <second>. The time is based on the 24-hour military-time clock. For example, 1 p.m. is 13:00:00. Hour displays hours from 00 to 23. Minute displays minutes from 00 to 59. Second displays seconds from 00 to 59.

► Advanced

The Advanced menu allows you to configure your system for basic operation. Some entries are defaults required by the system board, while others, if enabled, will improve the performance of your system or let you set some features according to your preference.

 **Important:**  
Setting incorrect field values may cause the system to malfunction.

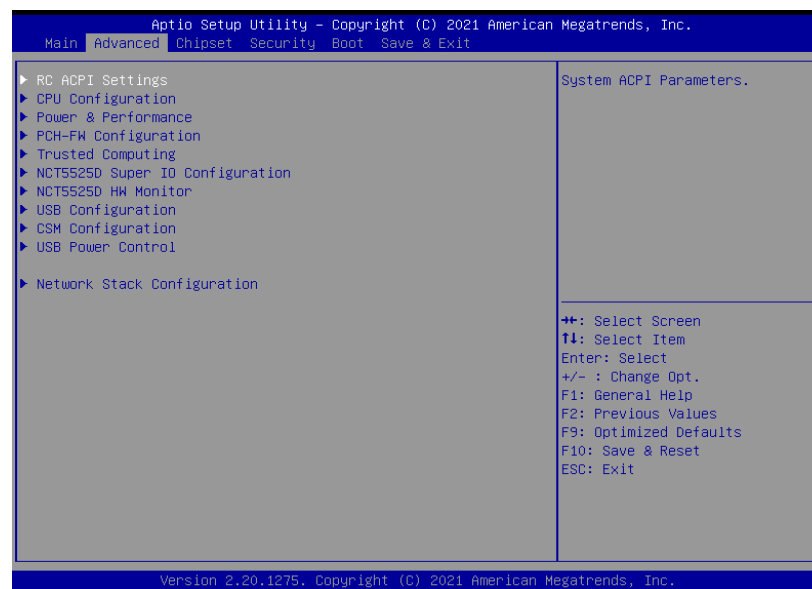

► Advanced

## RC ACPI Configuration

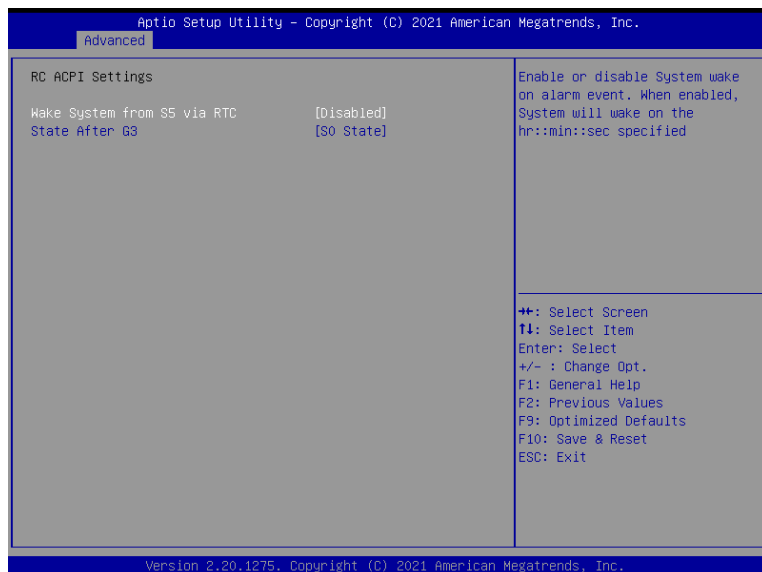

### Wake system from S5 via RTC

When Enabled, the system will automatically power up at a designated time every day. Once it's switched to [Enabled], please set up the time of day — hour, minute, and second — for the system to wake up.

### State After G3

Select between S0 State, and S5 State. This field is used to specify what state the system is set to return to when power is re-applied after a power failure (G3 state).

- S0 State** The system automatically powers on after power failure.
- S5 State** The system enter soft-off state after power failure. Power-on signal input is required to power up the system.
- Last State** The system returns to the last state right before power failure.

► Advanced

## CPU Configuration

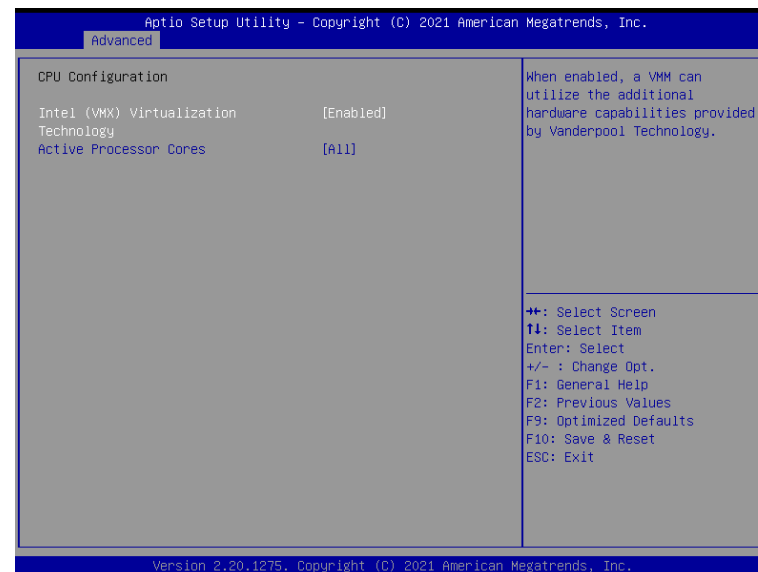

### Intel (VMX) Virtualization Technology

When this field is set to Enabled, the VMM can utilize the additional hardware capabilities provided by Vanderpool Technology.

### Active Processor Cores

Select number of cores to enable in each processor package: all or 1.

► Advanced

Power & Performance

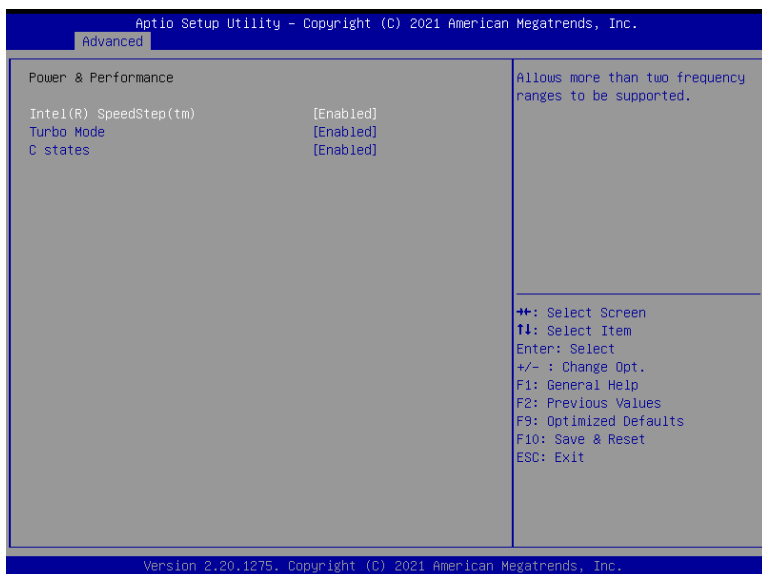

**Intel (R) SpeedStep(tm)**

This field is used to enable or disable the Intel SpeedStep® Technology, which helps optimize the balance between system's power consumption and performance. After it is enabled in the BIOS, EIST features can then be enabled via the operating system's power management.

**Turbo Mode**

Enable or disable turbo mode of the processor. This field will only be displayed when EIST is enabled.

**C states**

Enable or disable CPU Power Management. It allows CPU to enter "C states" when it's idle and nothing is executing.

► Advanced

PCH-FW Configuration

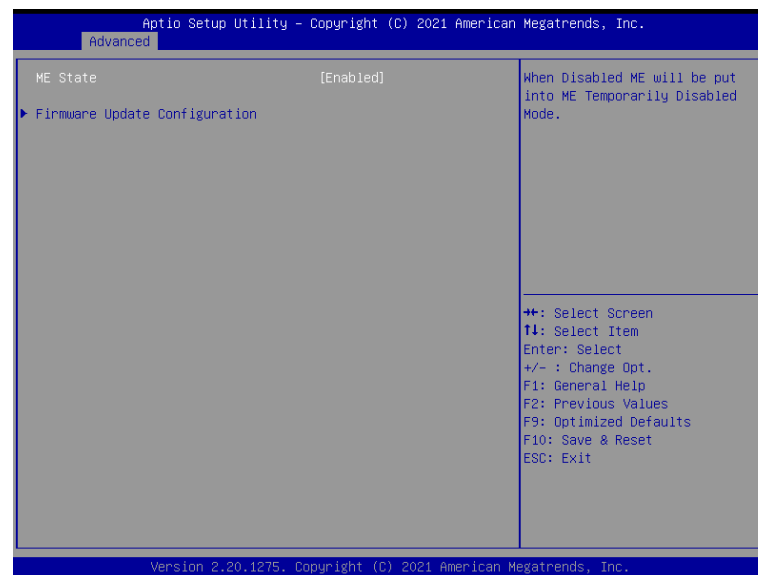

**ME State**

When this field is set to Disabled, ME will be put into ME Temporarily Disabled Mode.

**Firmware Update Configuration**

This field is used to enable or disable the Me FW Image Re-Flash function.



**Note:**  
The sub-menus are detailed in following sections.

▶ Advanced

Trusted Computing

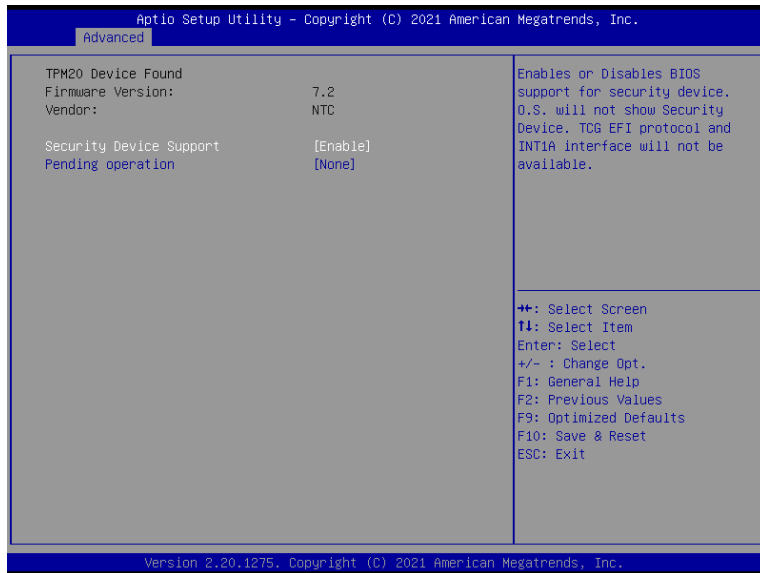

**Security Device Support**

This field is used to enable or disable BIOS support for the security device such as an TPM 2.0 to achieve hardware-level security via cryptographic keys.

**Pending operation**

To clear the existing TPM encryption, select "TPM Clear" and restart the system. This field is not available when "Security Device Support" is disabled.

▶ Advanced

NCT5525D Super IO Configuration



**WatchDog Timer Unit**

Select WatchDog Timer Unit – Second or Minute.

**SuperIO WatchDog Timer**

Set SuperIO WatchDog Timer Timeout value. The range is from 0 (disabled) to 255.



**Note:**  
The sub-menus are detailed in following sections.



▶ Advanced

NCT5525D Super IO Configuration ▶ Serial Port 1, 2 Configuration

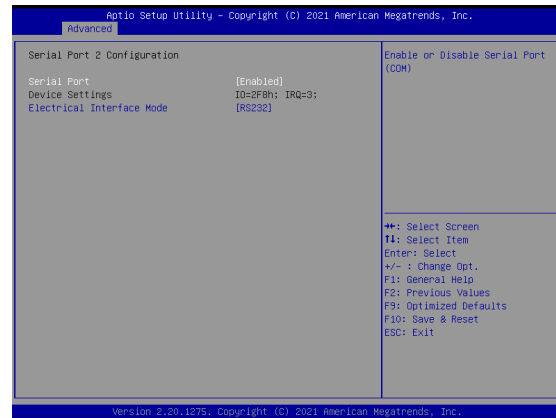
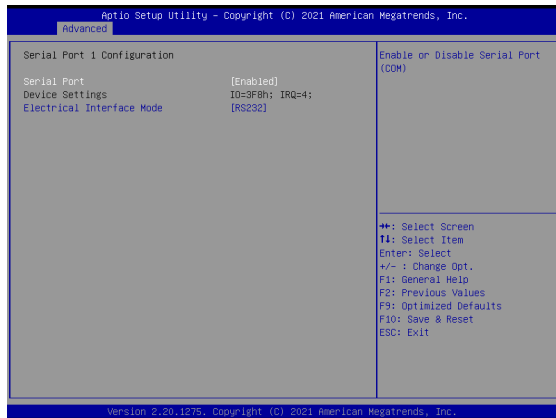

**Serial Port**

Enable or disable serial port.

**Electrical Interface Mode**

Choose mode between RS232 / RS485 / RS422

▶ Advanced

NCT5525D HW Monitor

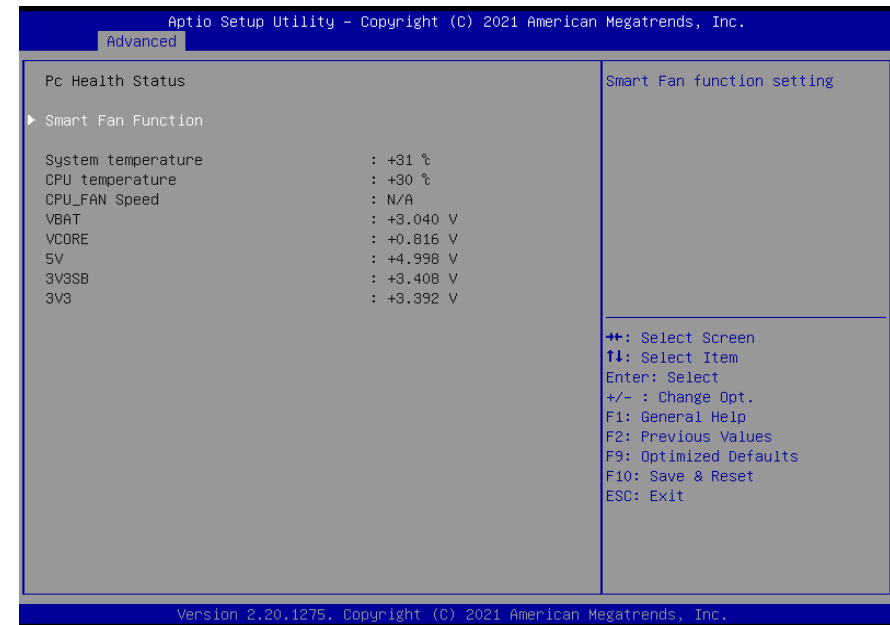

This section displays the system's health information, i.e. voltage readings, CPU and system temperatures.

▶ Advanced

## USB Configuration

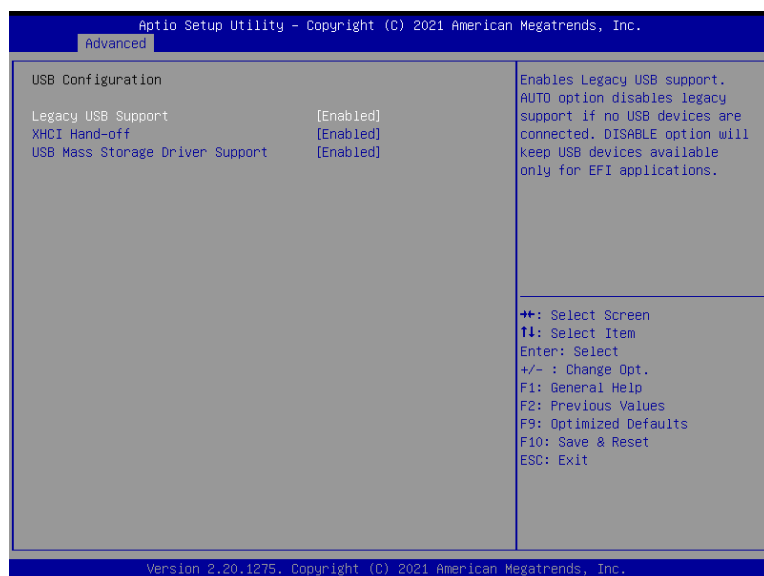

### Legacy USB Support

- **Enabled** Enable Legacy USB support.
- **Disabled** Keep USB devices available only for EFI applications.
- **Auto** Disable Legacy support if no USB devices are connected.

### XHCI Hand-off

Enable or disable XHCI Hand-off.

### USB Mass Storage Driver Support

Enable or disable USB Mass Storage Driver Support.

▶ Advanced

## CSM Configuration

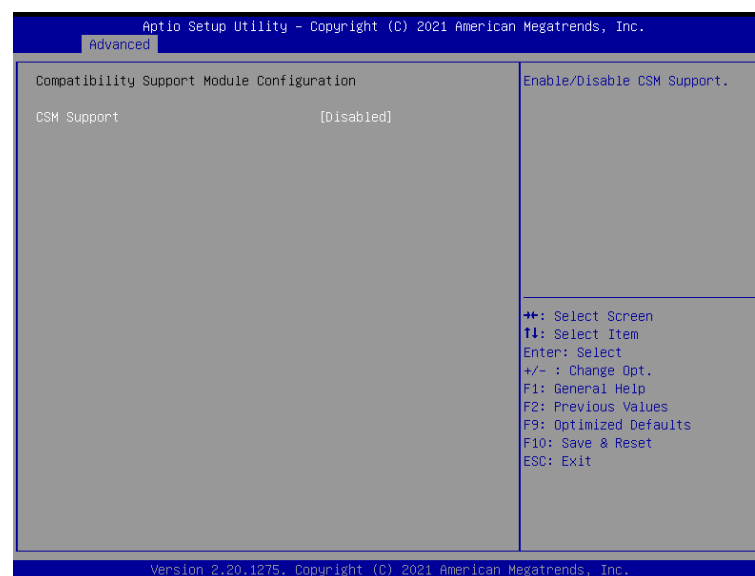

### CSM (Compatibility Support Module) Support

Enable or disable CSM Support.

► Advanced

USB Power Control



**USB Power**

5V\_Dual: Support system wake from S3/S4 by USB KB&MS  
 5V: No Support system wake from S3/S4 by USB KB&MS

► Advanced

Network Stack Configuration

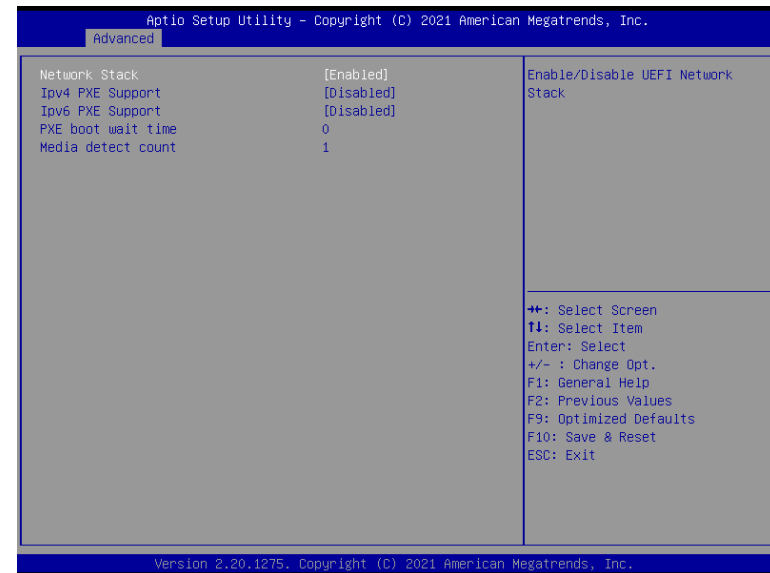

**Network Stack**

Enable or disable (Default) UEFI network stack. The following fields will appear when this field is enabled.

**Ipv4 PXE Support** Enable or disable IPv4 PXE boot support. If disabled, IPv4 PXE boot support will not be available.

**Ipv6 PXE Support**

Enable or disable IPv6 PXE boot support. If disabled, IPv6 PXE boot support will not be available.

**PXE boot wait time**

Set the wait time in seconds to press ESC key to abort the PXE boot. Use either +/- or numeric keys to set the value.

**Media detect count**

Set the number of times the presence of media will be checked. Use either +/- or numeric keys to set the value.

► Chipset

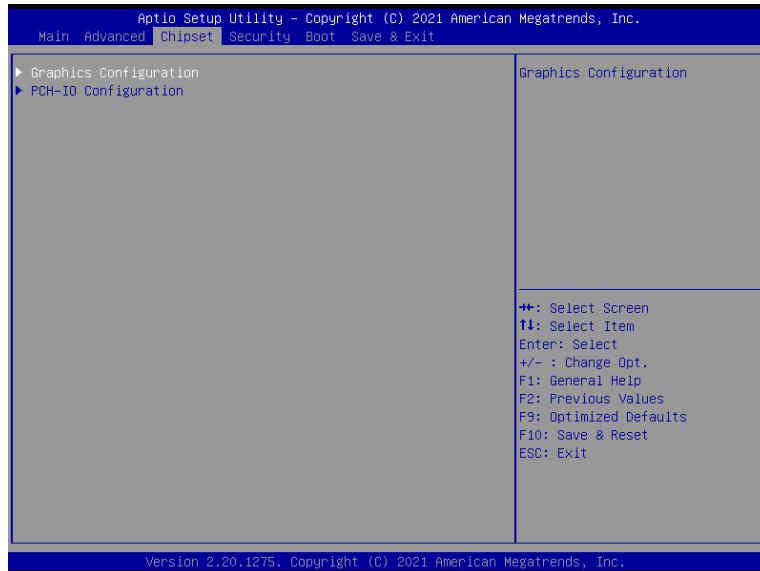

► Chipset

Graphics Configuration

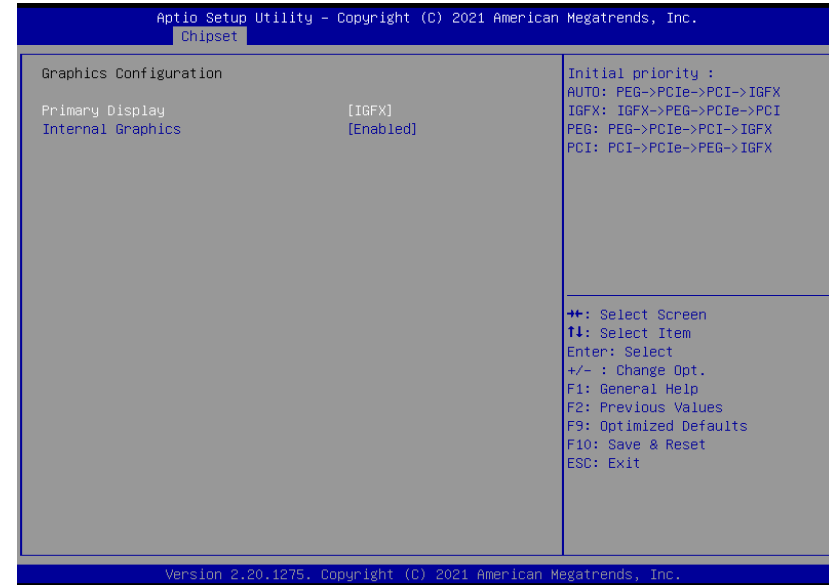

**Primary Display**

Select which of IGFX/PEG/PCI Graphics device to be the primary display.

**Internal Graphics**

Keep IGFX "Enabled" or "Disabled" based on the setup options, or select "Auto" for auto-detection.

## PCH-IO Configuration

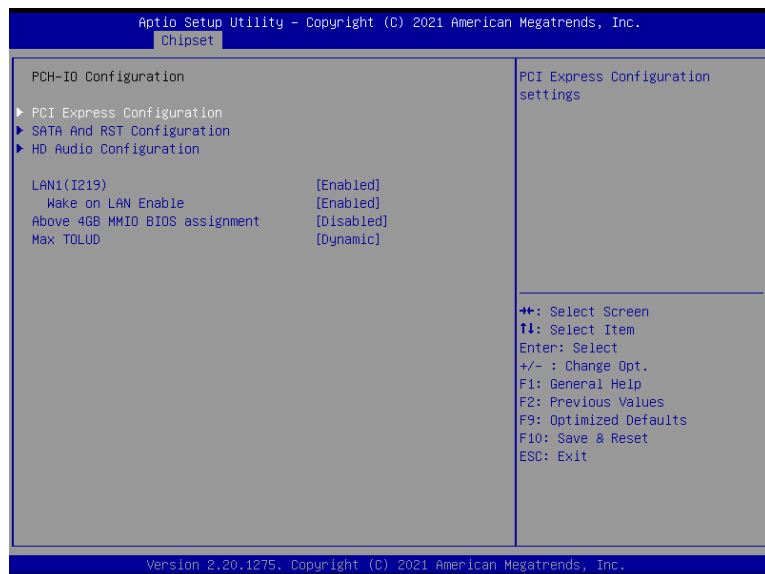

### PCI Express Configuration

PCI Express Configuration Settings

### SATA And RST Configuration

SATA Device Options Settings

### HD Audio Configuration

HD Audio Subsystem Configuration Settings

### LAN1(I219)

Enable or disable onboard NIC.

### Wake on LAN Enable

Enable or disable integrated LAN to wake the system.

### Above 4GB MMIO BIOS assignment

Enable/Disable above 4GB MemoryMappedIO BIOS assignment. This is enabled automatically when Aperture Size is set to 2048MB.

### Max TOLUD

Assign the maximum value of Top Of Lower Usable DRAM (TOLUD). Select to specify a fixed value, or select "Dynamic" so that the assignment would adjust TOLUD automatically based on largest MMIO length of installed graphic controller.

► Chipset

PCH-IO Configuration ► PCI Express Configuration

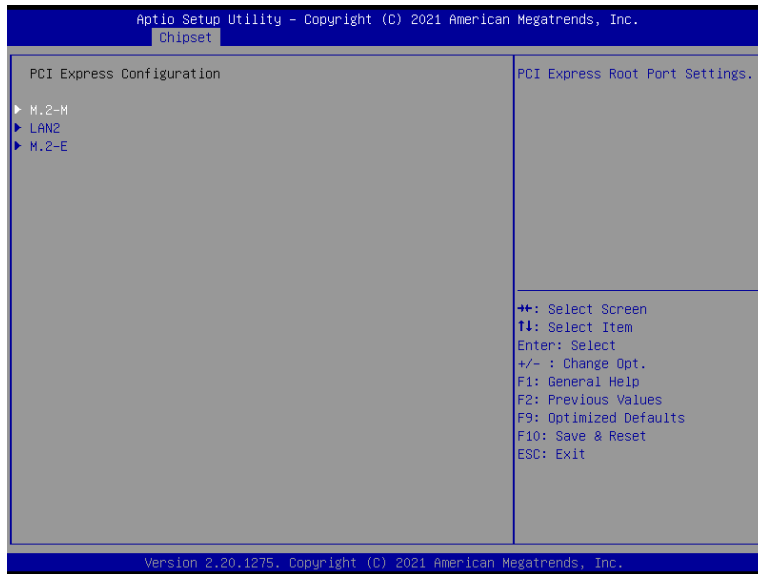

Select one of the PCI Express channels and press enter to configure the following settings.

**M.2-E, M.2-M, LAN2**

Control the PCI Express Root Port.

► Chipset

PCH-IO Configuration ► SATA And RST Configuration

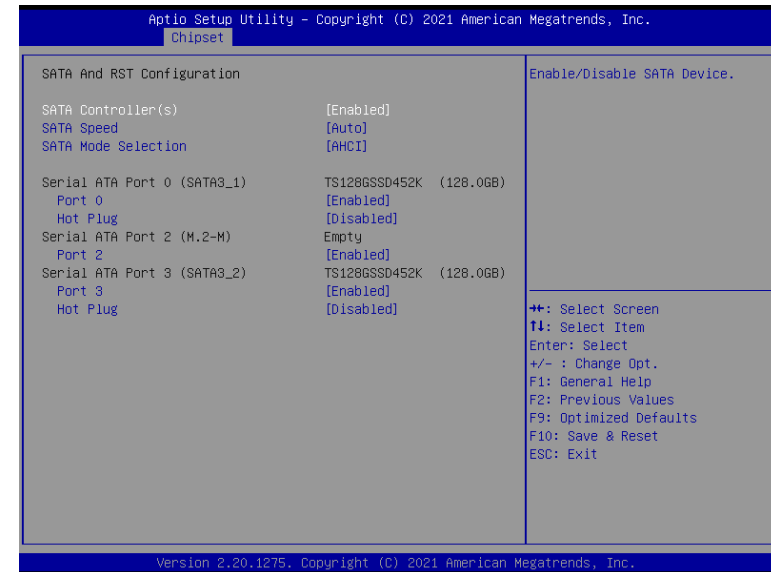

**SATA Controller(s)**

This field is used to enable or disable the Serial ATA controller.

**SATA Speed**

This field is used to select SATA speed generation limit: Auto, Gen1, Gen2 or Gen3.

**SATA Mode Selection**

The mode selection determines how the SATA controller(s) operates.

- **AHCI** This option allows the Serial ATA controller(s) to use AHCI (Advanced Host Controller Interface).
- **Intel RST Premium With Intel Optane System Acceleration** This option allows you to create RAID or Intel Rapid Storage configuration along with Intel® Optane™ system acceleration on Serial ATA devices.

**Ports and Hot Plug**

Enable or disable the Serial ATA port and its hot plug function.



► Chipset

PCH-IO Configuration ► **HD Audio Configuration**



**HD Audio**

Control the detection of the HD Audio device.

- Disabled**      HDA will be unconditionally disabled.
- Enabled**      HDA will be unconditionally enabled.

► Security

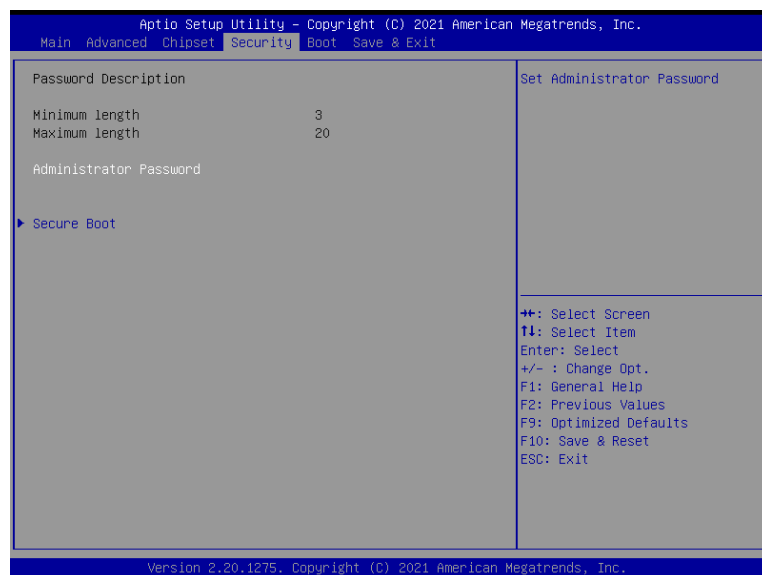

**Administrator Password**

Set the administrator password. To clear the password, input nothing and press enter when a new password is asked. Administrator Password will be required when entering the BIOS.

► Security

Secure Boot



**Secure Boot**

Secure Boot feature is Active if secure Boot is Enabled, Platform Key (PK) is enrolled and the system is in user mode. The mode change requires platform reset.

**Secure Boot Mode**

Select the secure boot mode – Standard or Custom. When set to Custom, the following fields will be configurable for the user to manually modify the key database.

**Restore Factory Keys**

Force system to User Mode. Load OEM-defined factory defaults of keys and databases onto the Secure Boot. Press Enter and a prompt will show up for you to confirm.

**Reset To Setup Mode**

Clear the database from the NVRAM, including all the keys and signatures installed in the Key Management menu. Press Enter and a prompt will show up for you to confirm.

► Boot

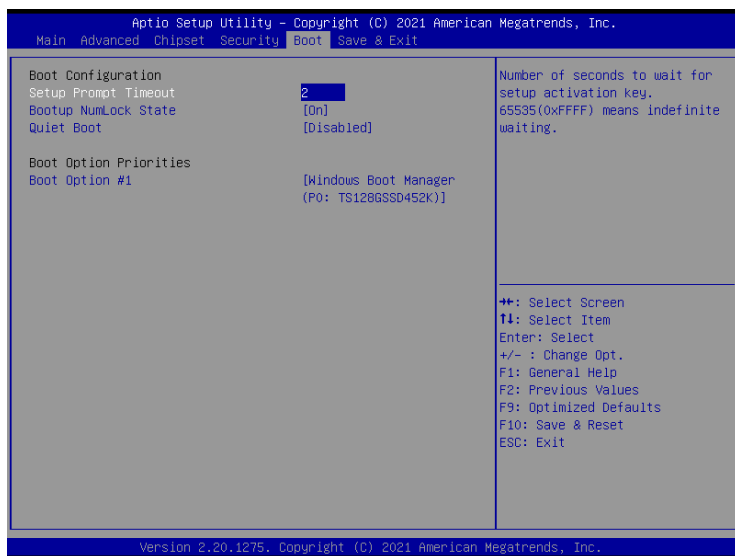

**Setup Prompt Timeout**

Set the number of seconds to wait for the setup activation key. 65535 (0xFFFF) denotes indefinite waiting.

**Bootup NumLock State**

Select the keyboard NumLock state: On or Off.

**Quiet Boot**

This section is used to enable or disable quiet boot option.

**Boot Option Priorities**

Rearrange the system boot order of available boot devices.

► Save & Exit

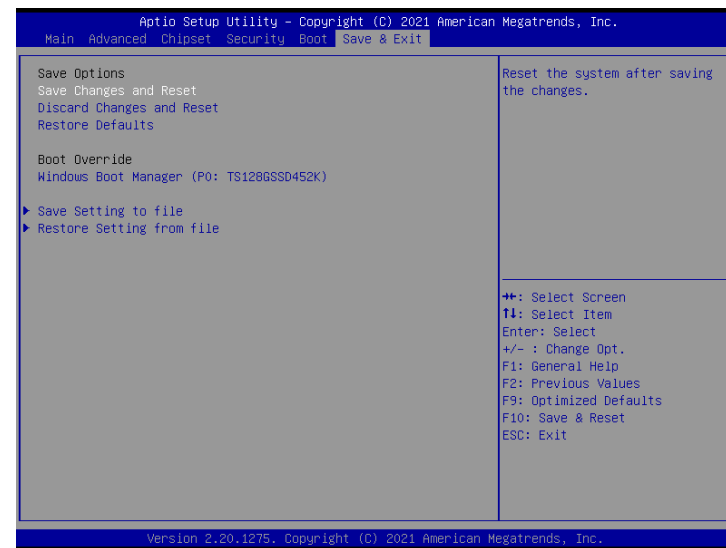

**Save Changes and Reset**

To save the changes, select this field and then press <Enter>. A dialog box will appear. Select Yes to reset the system after saving all changes made.

**Discard Changes and Reset**

To discard the changes, select this field and then press <Enter>. A dialog box will appear. Select Yes to reset the system setup without saving any changes.

**Restore Defaults**

To restore and load the optimized default values, select this field and then press <Enter>. A dialog box will appear. Select Yes to restore the default values of all the setup options.

**Boot Override**

Move the cursor to an available boot device and press Enter, and then the system will immediately boot from the selected boot device. The Boot Override function will only be effective for the current boot. The "Boot Option Priorities" configured in the Boot menu will not be changed.

► **Save Setting to file**

Select this option to save BIOS configuration settings to a USB flash device.

► **Restore Setting from file**

This field will appear only when a USB flash device is detected. Select this field to restore setting from the USB flash device.

## ► Updating the BIOS

To update the BIOS, you will need the new BIOS file and a flash utility. Please contact technical support or your sales representative for the files and specific instructions about how to update BIOS with the flash utility.

## ► Notice: BIOS SPI ROM

1. The Intel® Management Engine has already been integrated into this system board. Due to the safety concerns, the BIOS (SPI ROM) chip cannot be removed from this system board and used on another system board of the same model.
2. The BIOS (SPI ROM) on this system board must be the original equipment from the factory and cannot be used to replace one which has been utilized on other system boards.
3. If you do not follow the methods above, the Intel® Management Engine will not be updated and will cease to be effective.



**Note:**

- a. You can take advantage of flash tools to update the default configuration of the BIOS (SPI ROM) to the latest version anytime.
- b. When the BIOS IC needs to be replaced, you have to populate it properly onto the system board after the EEPROM programmer has been burned and follow the technical person's instructions to confirm that the MAC address should be burned or not.
- c. After updating unique MAC Address from manufacturing, NVM will be protected immediately after power cycle. Users cannot update NVM or MAC address.