

# **SU251/SU253**

**Embedded SBC 4"**  
**User's Manual**

## Copyright

This publication contains information that is protected by copyright. No part of it may be reproduced in any form or by any means or used to make any transformation/adaptation without the prior written permission from the copyright holders.

This publication is provided for informational purposes only. The manufacturer makes no representations or warranties with respect to the contents or use of this manual and specifically disclaims any express or implied warranties of merchantability or fitness for any particular purpose. The user will assume the entire risk of the use or the results of the use of this document. Further, the manufacturer reserves the right to revise this publication and make changes to its contents at any time, without obligation to notify any person or entity of such revisions or changes.

Changes after the publication's first release will be based on the product's revision. The website will always provide the most updated information.

© 2017. All Rights Reserved.

## Trademarks

Product names or trademarks appearing in this manual are for identification purpose only and are the properties of the respective owners.

## FCC and DOC Statement on Class B

This equipment has been tested and found to comply with the limits for a Class B digital device, pursuant to Part 15 of the FCC rules. These limits are designed to provide reasonable protection against harmful interference when the equipment is operated in a residential installation. This equipment generates, uses and can radiate radio frequency energy and, if not installed and used in accordance with the instruction manual, may cause harmful interference to radio communications. However, there is no guarantee that interference will not occur in a particular installation. If this equipment does cause harmful interference to radio or television reception, which can be determined by turning the equipment off and on, the user is encouraged to try to correct the interference by one or more of the following measures:

- Reorient or relocate the receiving antenna.
- Increase the separation between the equipment and the receiver.
- Connect the equipment into an outlet on a circuit different from that to which the receiver is connected.
- Consult the dealer or an experienced radio TV technician for help.

## Notice:

1. The changes or modifications not expressly approved by the party responsible for compliance could void the user's authority to operate the equipment.
2. Shielded interface cables must be used in order to comply with the emission limits.

## Table of Contents

Copyright.....	2
Trademarks.....	2
FCC and DOC Statement on Class B.....	2
About this Manual .....	4
Warranty .....	4
Static Electricity Precautions.....	4
Safety Measures.....	4
Before Using the System Board.....	5
Chapter 1 - Introduction.....	6
Chapter 2 - Hardware Installation .....	8
Board Layout.....	8
Block Diagram.....	9
Mechanical Diagram.....	9
System CPU.....	10
Installing the Heat Sink .....	10
System Memory.....	11
Jumper Settings .....	11
Clear CMOS Data .....	11
Auto Power-on Select .....	12
Mini PCIe Signal Select.....	12
LVDS Backlight Voltage Select .....	13
LVDS DIMM Control.....	13
LVDS Panel Voltage Select.....	14
COM4/DIO Pin Select.....	14
eDP Backlight Voltage Select (optional).....	15
eDP Panel Voltage Select (optional).....	15
eDP Invert Voltage Select (optional).....	16
Front Panel I/O Ports.....	17
Rear Panel I/O Ports .....	17
12V DC-in (SU251)/15~36V DC-in (SU253) .....	18

Graphics Interfaces .....	18
USB Ports.....	19
COM (Serial) Ports .....	20
RJ45 LAN Ports .....	21
Audio.....	21
I/O Connectors.....	22
Serial ATA Connector .....	22
Serial ATA Power Connector.....	22
LVDS LCD Panel Connector.....	23
LCD/Inverter Power Connector.....	23
Cooling Fan Connector.....	24
Chassis Intrusion Connector .....	24
Expansion Slots .....	25
SMBus Connector.....	25
Front Panel Connector .....	26
Standby Power LED.....	27
Battery .....	27

## Chapter 3 - BIOS Setup..... 28

Overview .....	28
Insyde BIOS Setup Utility.....	29
Main .....	29
Advanced .....	29
Security .....	39
Boot .....	41
Exit .....	43
Updating the BIOS.....	44
Notice: BIOS SPI ROM.....	44

## Chapter 4 - Supported Software..... 45

## Chapter 5 - RAID .....

## Chapter 6 - Intel AMT Settings..... 64

## Appendix A - Troubleshooting Checklist 77

## About this Manual

This manual can be downloaded from the website, or acquired as an electronic file included in the optional CD/DVD. The manual is subject to change and update without notice, and may be based on editions that do not resemble your actual products. Please visit our website or contact our sales representatives for the latest editions.

## Warranty

1. Warranty does not cover damages or failures that arised from misuse of the product, inability to use the product, unauthorized replacement or alteration of components and product specifications.
2. The warranty is void if the product has been subjected to physical abuse, improper installation, modification, accidents or unauthorized repair of the product.
3. Unless otherwise instructed in this user's manual, the user may not, under any circumstances, attempt to perform service, adjustments or repairs on the product, whether in or out of warranty. It must be returned to the purchase point, factory or authorized service agency for all such work.
4. We will not be liable for any indirect, special, incidental or consequential damages to the product that has been modified or altered.

## Static Electricity Precautions

It is quite easy to inadvertently damage your PC, system board, components or devices even before installing them in your system unit. Static electrical discharge can damage computer components without causing any signs of physical damage. You must take extra care in handling them to ensure against electrostatic build-up.

1. To prevent electrostatic build-up, leave the system board in its anti-static bag until you are ready to install it.
2. Wear an antistatic wrist strap.
3. Do all preparation work on a static-free surface.
4. Hold the device only by its edges. Be careful not to touch any of the components, contacts or connections.
5. Avoid touching the pins or contacts on all modules and connectors. Hold modules or connectors by their ends.



### Important:

Electrostatic discharge (ESD) can damage your processor, disk drive and other components. Perform the upgrade instruction procedures described at an ESD workstation only. If such a station is not available, you can provide some ESD protection by wearing an antistatic wrist strap and attaching it to a metal part of the system chassis. If a wrist strap is unavailable, establish and maintain contact with the system chassis throughout any procedures requiring ESD protection.

## Safety Measures

To avoid damage to the system:

- Use the correct AC input voltage range.

To reduce the risk of electric shock:

- Unplug the power cord before removing the system chassis cover for installation or servicing. After installation or servicing, cover the system chassis before plugging the power cord.

## Before Using the System Board

Before using the system board, prepare basic system components. If you are installing the system board in a new system, you will need at least the following internal components.

- Storage devices such as hard disk drive, DVD-ROM, etc.

You will also need external system peripherals you intend to use which will normally include at least a keyboard, a mouse and a video display monitor.

# Chapter 1 - Introduction

## Specifications

<b>SYSTEM</b>	Processor	6th Generation Intel® Core™ Processors, BGA 1356 (Skylake-U*) Intel® Core™ i7-6600U Processor, Dual Core, 4M Cache, 2.6GHz (3.4GHz), 15W Intel® Core™ i5-6300U Processor, Dual Core, 3M Cache, 2.4GHz (3.0GHz), 15W Intel® Core™ i3-6100U Processor, Dual Core, 3M Cache, 2.3GHz, 15W Intel® Celeron® Processor 3955U, Dual Core, 2M Cache, 2.0GHz, 15W
	Memory	4GB/8GB Memory Down Dual Channel DDR4 2133MHz
	BIOS	Insyde SPI 128Mbit
<b>GRAPHICS</b>	Controller	Intel® HD Graphics GT Series
	Feature	OpenGL 5.0, DirectX 12, OpenCL 2.1 HW Decode: AVC/H.264, MPEG2, VC1/WMV9, JPEG/MJPEG, HEVC/H265, VP8, VP9 HW Encode: AVC/H.264, MPEG2, JPEG, HEVC/H265, VP8, VP9
	Display	1 x VGA 1 x DP++/HDMI (HDMI available upon request) 1 x LVDS/eDP (eDP available upon request) VGA: resolution up to 1920x1200 @ 60Hz DP++: resolution up to 4096x2304 @ 60Hz HDMI: resolution up to 2560x1600 @ 60Hz or 4096x2160 @ 24Hz LVDS: dual channel 48-bit, resolution up to 1920x1200 @ 60Hz eDP: resolution up to 3840x2160 @ 60Hz
	Triple Displays	VGA + DP++/HDMI (HDMI available upon request) + LVDS/eDP (eDP available upon request)
<b>EXPANSION</b>	Interface	1 x Full-size Mini PCIe (PCIe/USB) 1 x Half-size Mini PCIe (USB + PCIe/SATA, PCIe/SATA select by jumper setting, SATA by default)
<b>AUDIO</b>	Audio Codec	Realtek ALC888S-VD2-GR
<b>ETHERNET</b>	Controller	1 x Intel® I210AT PCIe (10/100/1000Mbps) 1 x Intel® I219LM PCIe with iAMT11.0 (10/100/1000Mbps) (only Core i7/i5 supports iAMT)
<b>Front I/O</b>	Serial	2 x RS-232/422/485; 1 x RS-232( also supports an optional 8-bit DIO)
	Display	1 x VGA
	Button	1 x Power Button 1 x Reset Button
<b>Rear I/O</b>	Ethernet	2 x GbE (RJ-45)
	Serial	1 x RS-232
	USB	4 x USB 3.0
	Audio	Mic-in; Line-out
	Display	1 x DP++/HDMI

<b>INTERNAL I/O</b>	Serial	2 x RS-232 (2.0mm pitch)
	USB	2 x USB 2.0 (2.00mm pitch)
	Display	1 x LVDS LCD Panel Connector 1 x LCD/Inverter Power Supports optional eDP connector
	Audio	1 x Audio (Line-out/Mic-in)
	SATA	2 x SATA 3.0 (up to 6Gb/s) 1 x SATA Power
	SMBus	1 x SMBus
	Other I/O	1 x front panel; 1 x chassis intrusion; 1 x fan connector
	<b>WATCHDOG TIMER</b>	Output & Interval
<b>SECURITY</b>	TPM	Available Upon Request
<b>POWER</b>	Type	Single 12V +/-10% DC (SU251) Wide Range 15~36V (SU253)
	Connector	2-pin Terminal Block
	Consumption	SU251 Typical: 6600U:12V @ 0.45A (5.44Watt) Max: 6600U:12V @ 3.14A (37.67Watt) SU253 Typical: 6600U:19V @ 0.46A (8.7Watt) Max: 6600U:19V @ 2.07A (39.29Watt)
	RTC Battery	CR2032 Coin Cell
<b>OS SUPPORT</b>	Microsoft/ Linux	Windows 7 (/WES7) (32/64-bit) Windows 8.1 (64-bit) Windows 10 IoT Enterprise (64-bit) Debian 8 (with VESA graphic driver) CentOS 7 (with VESA graphic driver) Ubuntu 15.10 (Intel graphic driver available)
<b>ENVIRONMENT</b>	Temperature	Operating: 0 to 60°C Storage: -40 to 85°C
	Humidity	Operating: 5 to 90% RH Storage: 5 to 90% RH
	MTBF	SU251: 369,377 hrs @ 25°C; 205,103 hrs @ 45°C; 123,607 hrs @ 60°C SU253: 359,921 hrs @ 25°C; 199,960 hrs @ 45°C; 120,832 hrs @ 60°C Calculation model: Telcordia Issue 2, Method I Case 3 Environment: GB, GC – Ground Benign, Controlled
<b>MECHANICAL</b>	Dimensions	4" SBC Form Factor 165mm (6.49") x 115mm (4.53")
	Height	PCB: 1.6mm Top Side: TBD, Bottom Side: TBD

\* When Intel Skylake-U processors are used for stress test with the BurnInTest™ software, it may result in CPU throttling. We provide a workaround for this situation. For more information, please contact our technical support at <http://www.dfi.com/support/support.html>.

## Features

- **Watchdog Timer**

The Watchdog Timer function allows your application to regularly “clear” the system at the set time interval. If the system hangs or fails to function, it will reset at the set time interval so that your system will continue to operate.

- **DDR4**

DDR4 deliver increased system bandwidth and improved performance. The advantages of DDR4 are its higher bandwidth and its increase in performance at a lower power than DDR3 and DDR3L. It is not compatible with older standards of DDR memories.

- **Graphics**

The integrated Intel® HD graphics engine delivers an excellent blend of graphics performance and features to meet business needs. It provides excellent video and 3D graphics with outstanding graphics responsiveness. These enhancements deliver the performance and compatibility needed for today's and tomorrow's business applications. Supports 1 LVDS (or eDP), 1 DisplayPort (or HDMI) and 1 VGA interfaces for display outputs.

- **Serial ATA**

Serial ATA is a storage interface that is compliant with SATA 1.0a specification. With speed of up to 6Gb/s (SATA 3.0), it improves hard drive performance faster than the standard parallel ATA whose data transfer rate is 100MB/s.

- **Gigabit LAN**

Two Intel® Gigabit LAN controllers (Intel® I210AT PCI Express Gigabit Ethernet controller and Intel® I219LM Gigabit Ethernet Phy) support up to 1Gbps data transmission.

- **Audio**

The Realtek ALC888S-VD2-GR audio codec provides 5.1-channel High Definition audio output.

- **Power Failure Recovery**

When power returns after an AC power failure, you may choose to either power-on the system manually or let the system power-on automatically.

- **USB**

The system board supports the new USB 3.0. It is capable of running at a maximum transmission speed of up to 5 Gbit/s (625 MB/s) and is faster than USB 2.0 (480 Mbit/s, or 60 MB/s) and USB 1.1 (12Mb/s). USB 3.0 reduces the time required for data transmission, reduces power consumption, and is backward compatible with USB 2.0. It is a marked improvement in device transfer speeds between your computer and a wide range of simultaneously accessible external Plug and Play peripherals.

- **Wake-On-LAN**

This feature allows the network to remotely wake up a Soft Power Down (Soft-Off) PC. It is supported via the onboard LAN port or via a PCI LAN card that uses the PCI PME (Power Management Event) signal. However, if your system is in the Suspend mode, you can power-on the system only through an IRQ or DMA interrupt.



**Important:**

The 5V\_standby power source of your power supply must support  $\geq 720\text{mA}$ .

- **Wake-On-USB (optional)**

This function allows you to use a USB keyboard or USB mouse to wake up a system from the S3 (STR - Suspend To RAM) state.



**Important:**

If you are using the Wake-On-USB Keyboard/Mouse function for 2 USB ports, the 5V\_standby power source of your power supply must support  $\geq 1.5\text{A}$ . For 3 or more USB ports, the 5V\_standby power source of your power supply must support  $\geq 2\text{A}$ .

- **ACPI STR**

The system board is designed to meet the ACPI (Advanced Configuration and Power Interface) specification. ACPI has energy saving features that enables PCs to implement Power Management and Plug-and-Play with operating systems that support OS Direct Power Management. ACPI when enabled in the Power Management Setup will allow you to use the Suspend to RAM function.

With the Suspend to RAM function enabled, you can power-off the system at once by pressing the power button or selecting “Standby” when you shut down Windows® without having to go through the sometimes tiresome process of closing files, applications and operating system. This is because the system is capable of storing all programs and data files during the entire operating session into RAM (Random Access Memory) when it powers-off. The operating session will resume exactly where you left off the next time you power-on the system.



**Important:**

The 5V standby power source of your power supply must support  $\geq 720\text{mA}$ .

- **RTC Timer**

The RTC installed on the system board allows your system to automatically power-on on the set date and time.

# Chapter 2 - Hardware Installation

## Board Layout

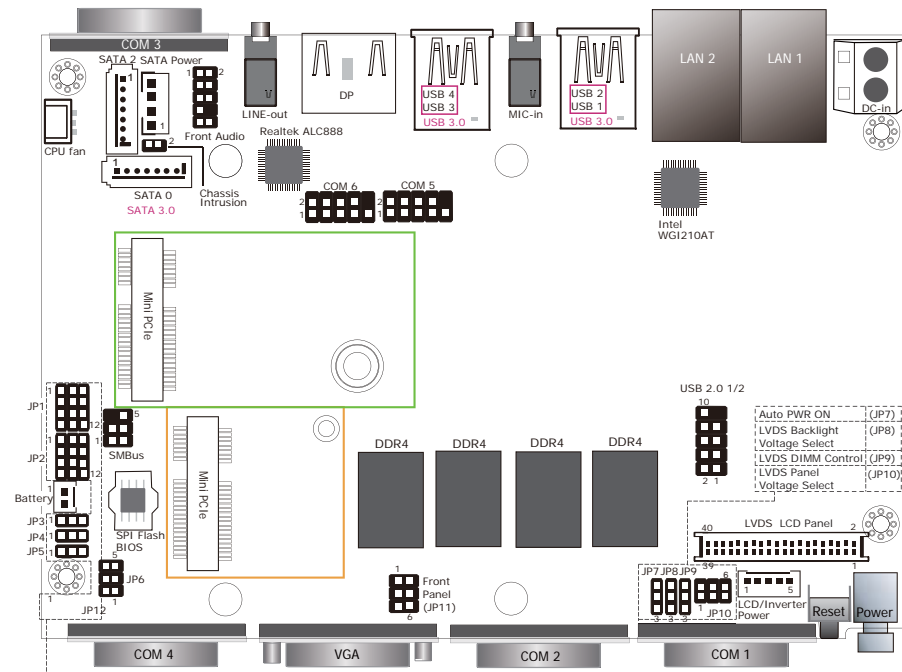

- COM4/DIO Pin Select (JP1)
- COM4/DIO Pin Select (JP2)
- Mini PCIe PCIe (JP3)
- SATA Select (JP4)
- Clear CMOS (JP5)
- eDP Backlight Voltage Select (JP6)
- eDP Panel Voltage Select (JP7)
- eDP Invert Voltage Select (JP12)

Top View

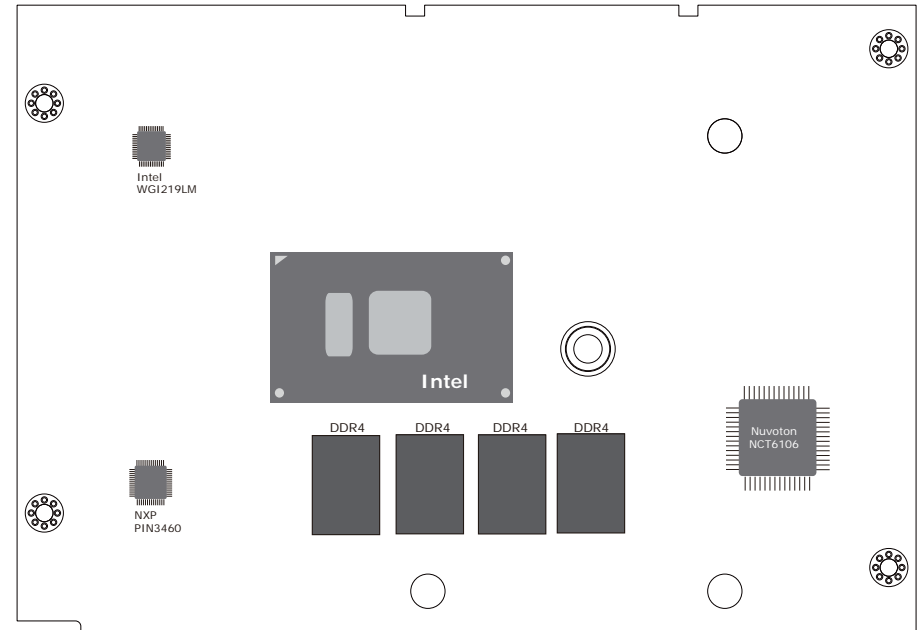

Bottom View



### Block Diagram

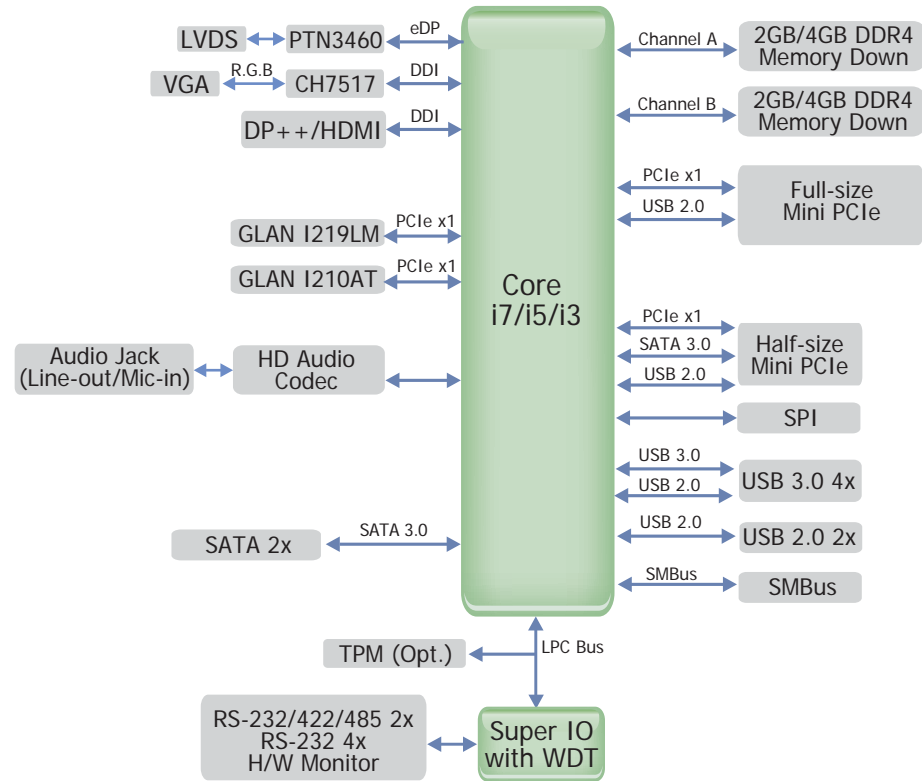

### Mechanical Diagram

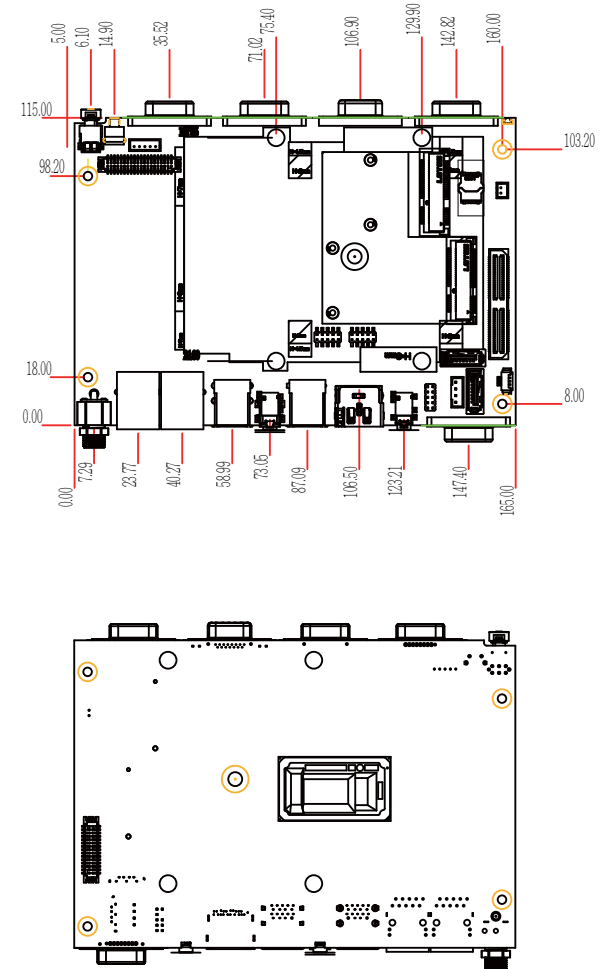

## System CPU

The system board is equipped with a Skylake-U microprocessor in socket BGA compatible package 1356.

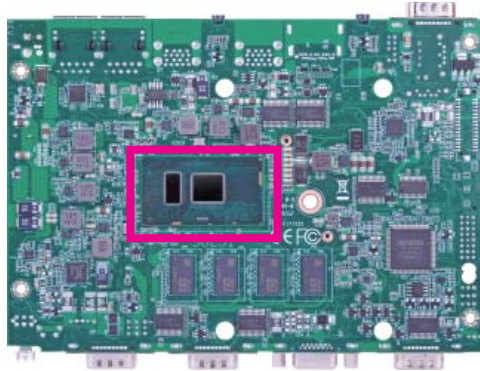

## Installing the Heat Sink

The CPU must be kept cool by using a CPU fan with heat sink. Without sufficient air circulation across the CPU and heat sink, the CPU will overheat damaging both the CPU and system board.

1. Before you install the fan / heat sink, you must apply a thermal paste onto the top of the CPU. The thermal paste is usually supplied when you purchase the fan / heat sink assembly. Do not spread the paste all over the surface. When you later place the heat sink on top of the CPU, the compound will disperse evenly.

Some heat sinks come with a patch of pre-applied thermal paste. Do not apply thermal paste if the fan / heat sink already has a patch of thermal paste on its underside. Peel the strip that covers the paste before you place the fan / heat sink on top of the CPU.

2. Place the heat sink on top of the CPU. The 4 captive screws around the heat sink, which are used to secure the heat sink onto the system board, must match the 4 mounting holes around the CPU on the system board.

Mounting holes

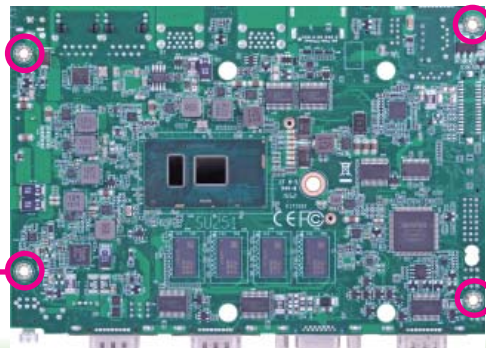

2. Use the standoffs and captive screws to fasten the heat sink on the system board.

Captive screws

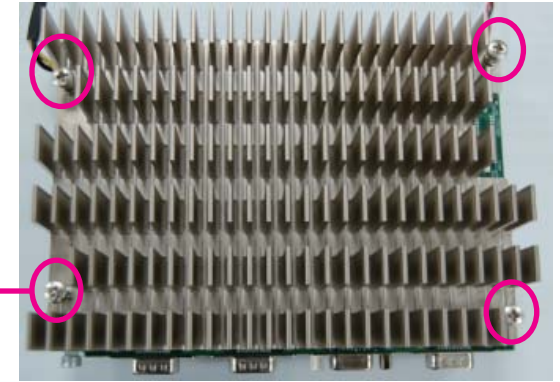

Standoffs



**Important:**

Electrostatic discharge (ESD) can damage your board, processor, disk drives, add-in boards, and other components. Perform installation procedures at an ESD workstation only. If such a station is not available, you can provide some ESD protection by wearing an antistatic wrist strap and attaching it to a metal part of the system chassis. If a wrist strap is unavailable, establish and maintain contact with the system chassis throughout any procedures requiring ESD protection.

## System Memory

**Important:**

When the Standby Power LED lights red, it indicates that there is power on the system board. Power-off the PC then unplug the power cord prior to installing any devices. Failure to do so will cause severe damage to the motherboard and components.

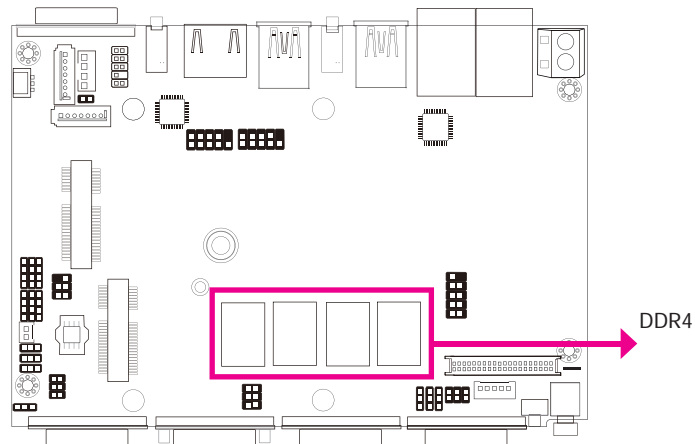

### Features

- 4GB/8GB Memory Down
- Dual channel DDR4 2133MHz

## Jumper Settings

### Clear CMOS Data

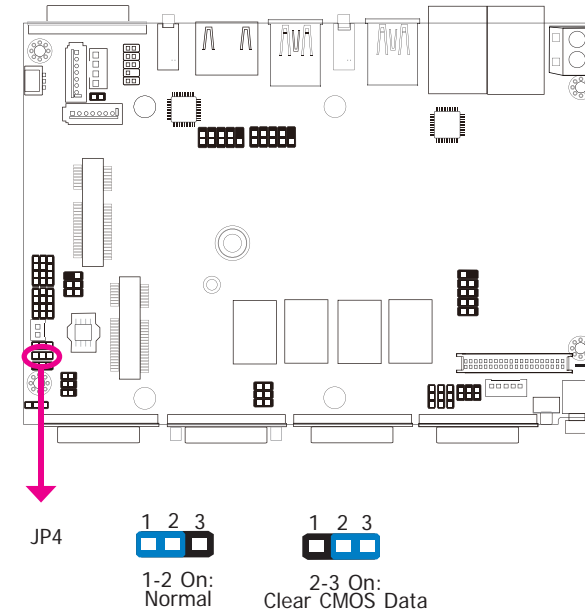

If you encounter the following,

- a) CMOS data becomes corrupted.
- b) You forgot the supervisor or user password.

you can reconfigure the system with the default values stored in the ROM BIOS.

To load the default values stored in the ROM BIOS, please follow the steps below.

1. Power-off the system and unplug the power cord.
2. Set JP4 pins 2 and 3 to On. Wait for a few seconds and set JP4 back to its default setting, pins 1 and 2 On.
3. Now plug the power cord and power-on the system.

## Auto Power-on Select

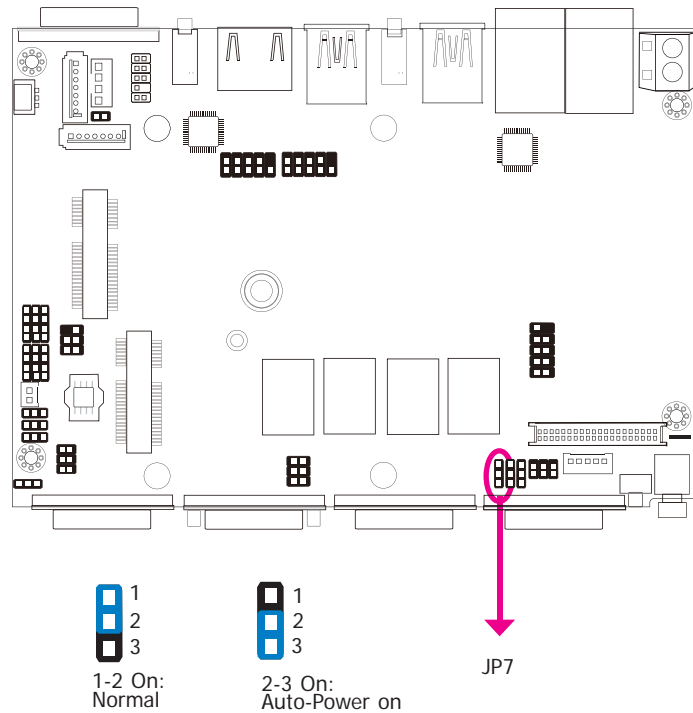

JP7 is used to select the method of powering on the system. If you want the system to power-on whenever AC power comes in, set JP7 pins 2 and 3 to On. If you want to use the power button, set pins 1 and 2 to On.

When using the JP7 "Power On" feature to power the system back on after a power failure occurs, the system may not power on if the power lost is resumed within 5 seconds (power flicker).

## Mini PCIe Signal Select

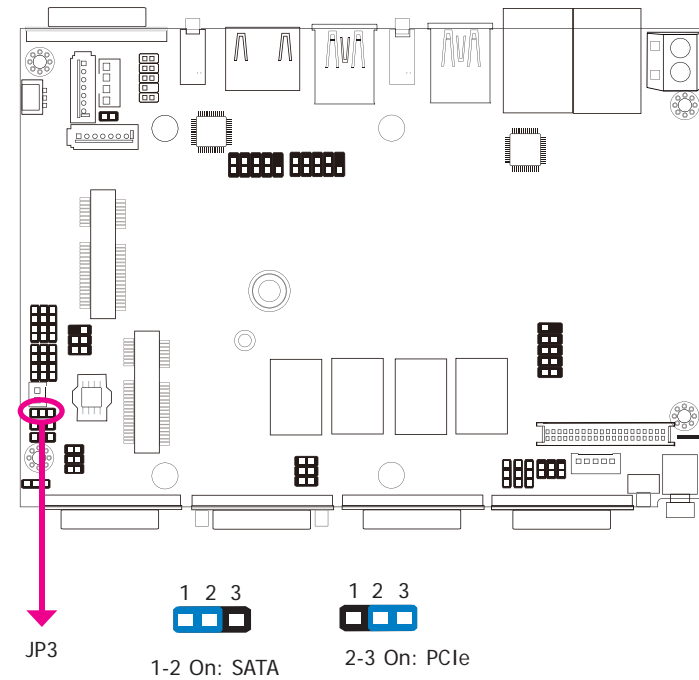

JP3 is used to select the Mini PCIe signal: PCIe or mSATA (default).

## LVDS Backlight Voltage Select

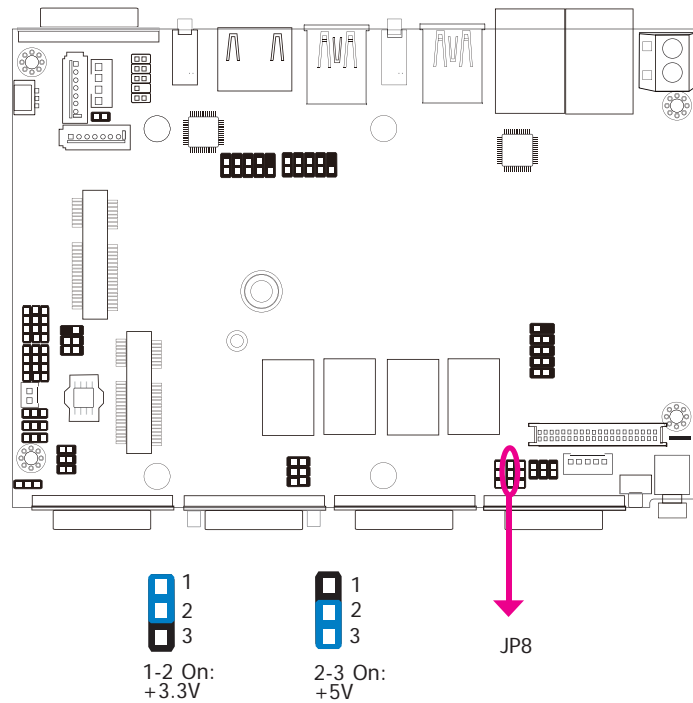

JP8 allows you to select the power level of the LVDS backlight brightness control: 3.3V or 5V.

**Important:**

Before powering-on the system, make sure that the power settings of JP8 match the power specification of backlight control. Selecting the incorrect voltage will seriously damage the backlight.

## LVDS DIMM Control

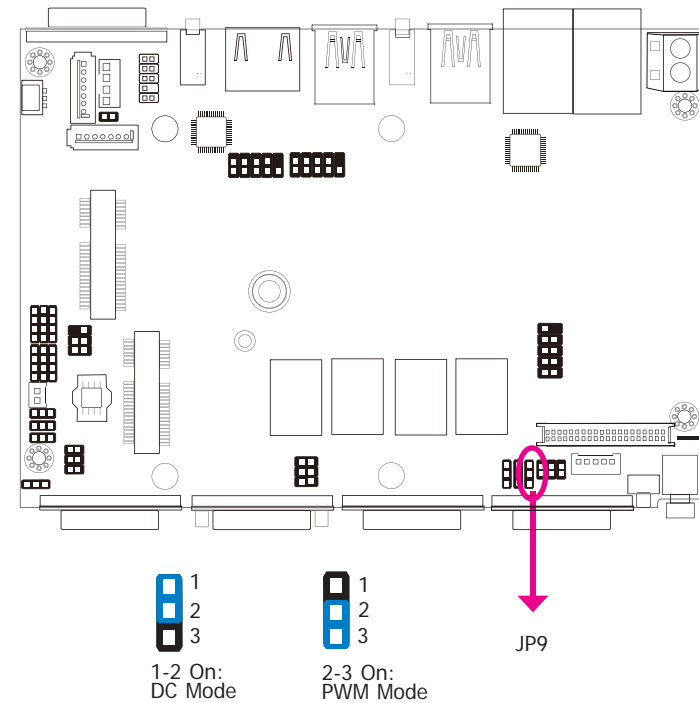

JP9 allows you to select the mode for the lightness control of the LVDS panel.

**Important:**

You need to refer to your panel's user guide to determine the type of mode most appropriate for your panel.

### LVDS Panel Voltage Select

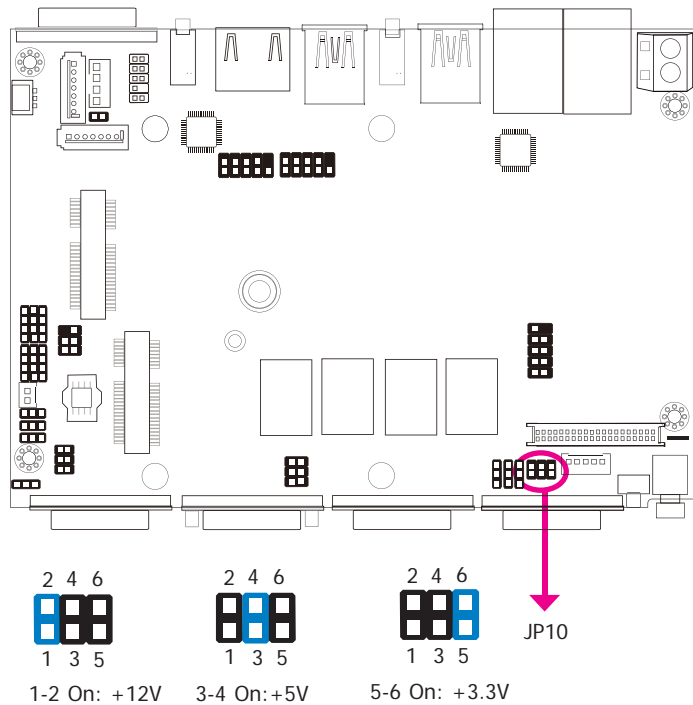

JP10 allows you to select the power voltage of the LVDS panel.



**Important:**

Before powering-on the system, make sure that the power settings of JP10 match the power specification of LVDS panel's specification. Selecting the incorrect voltage will seriously damage the LVDS panel. .

### COM4/DIO Pin Select

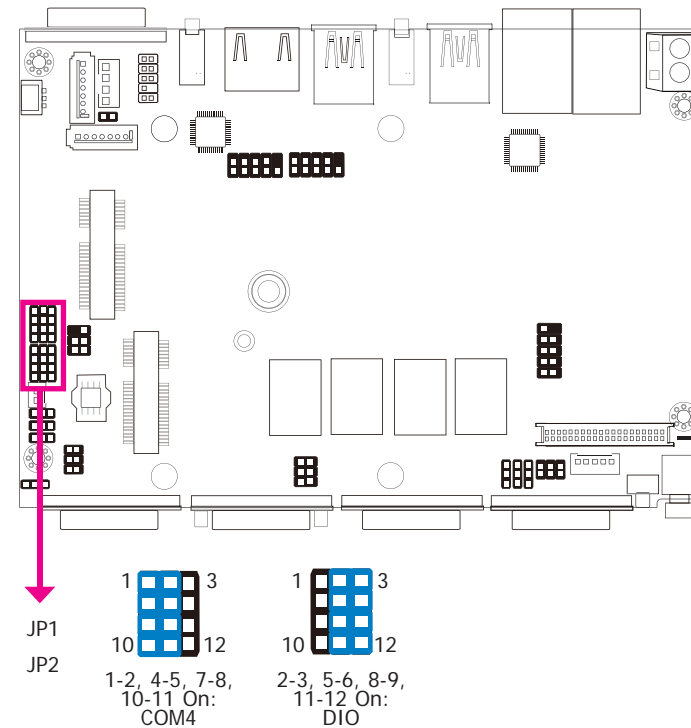

The system board uses JP1 and JP2 to select between RS232/422/485 COM 4 or isolated 8-bit DIO at the rear panel.



**Important:**

You cannot use COM 4 and DIO at the same time. Please set up JP1 and JP2 together.

## eDP Backlight Voltage Select (optional)

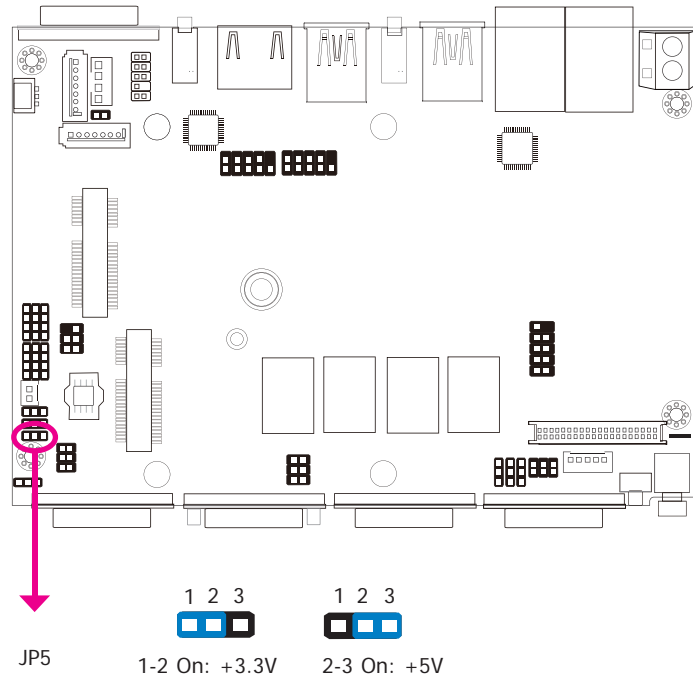

JP5 is used to select the power level of backlight brightness control: +3.3V or +5V.

**Important:**

Before powering-on the system, make sure that the power settings of JP5 match the power specification of backlight control. Selecting the incorrect voltage will seriously damage the backlight.

## eDP Panel Voltage Select (optional)

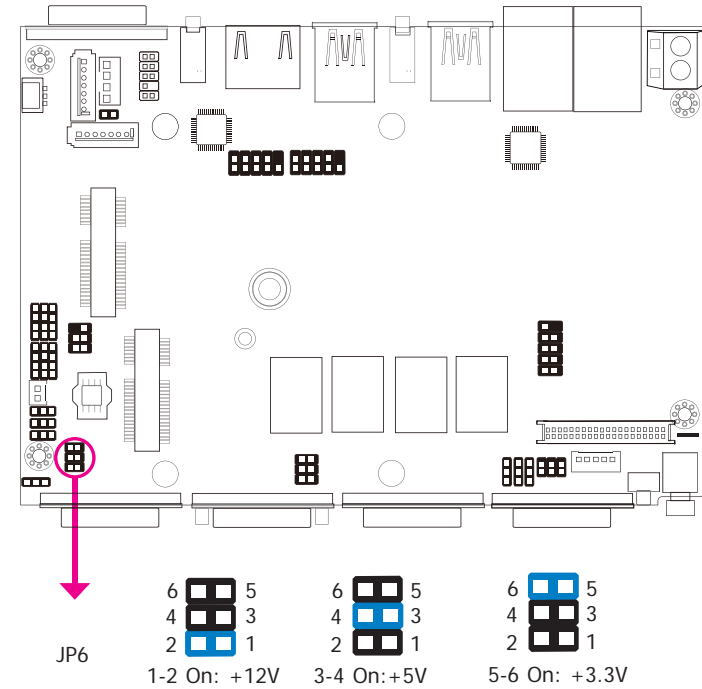

JP6 is used to select the power supplied with the LCD panel.

**Important:**

Before powering-on the system, make sure that the power settings of JP6 match the LCD panel's specification. Selecting the incorrect voltage will seriously damage the LCD panel.

## eDP Invert Voltage Select (optional)

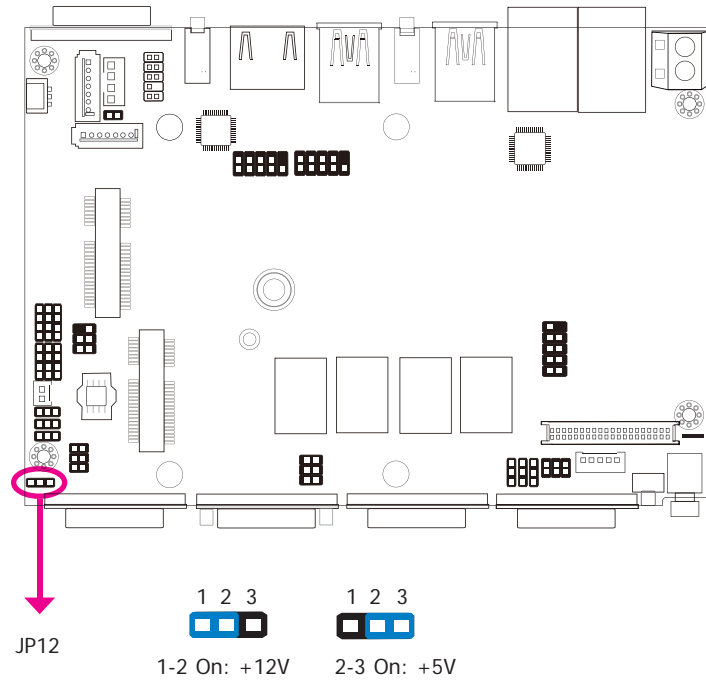

JP12 is used to select the power level of the LCD/inverter power connector: +12V or +5V.



## Front Panel I/O Ports



The front panel I/O ports consist of the following:

- 3 serial ports
  - Two of them support RS232/422/485
  - One (COM4) supports only RS232 with an optional 8-bit DIO
- 1 VGA port
- 1 power button
- 1 reset button

## Rear Panel I/O Ports



The rear panel I/O ports consist of the following:

- 2 RJ45 LAN ports
- 4 USB 3.0 ports
- 1 DP++/HDMI (optional) port
- 1 serial port supporting RS232
- 1 Mic-in jack
- 1 Line-out jack

## 12V DC-in (SU251)/15~36V DC-in (SU253)

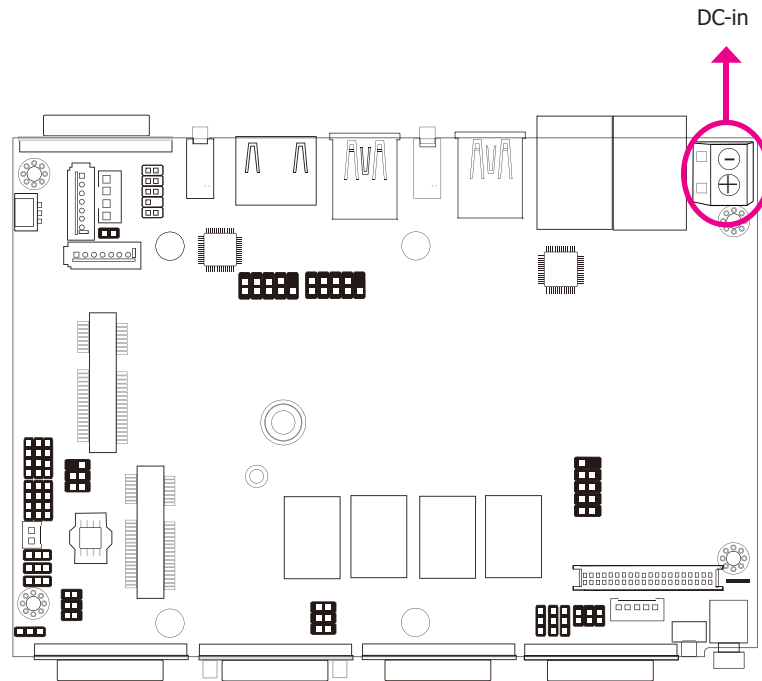

This 2-pin terminal block provides maximum of 100W/120W power and is considered a low power solution. Connect a DC power cord to this terminal block. Using a voltage more than the recommended range may fail to boot the system or cause damage to the system board.

## Graphics Interfaces

The display ports consist of the following:

- 1 DP++/HDMI (optional) port
- 1 VGA port

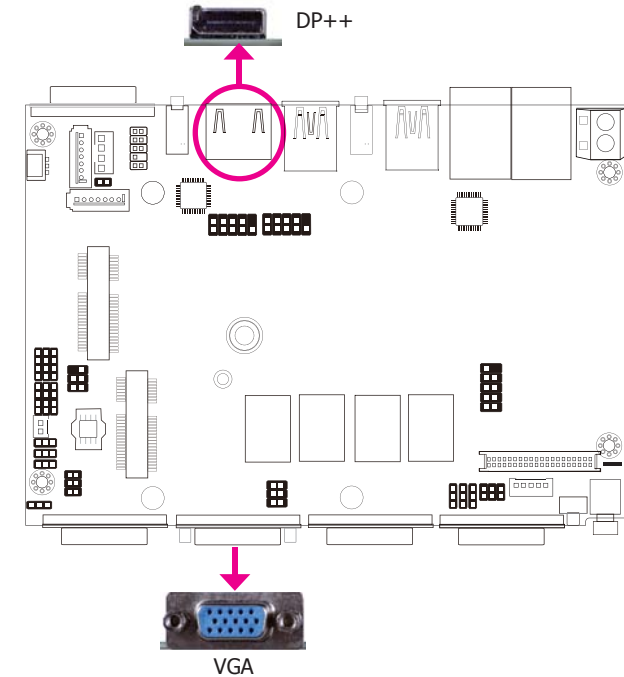

### VGA Port

The VGA port is used for connecting a VGA monitor. Connect the monitor's 15-pin D-shell cable connector to the VGA port. After you plug the monitor's cable connector into the VGA port, gently tighten the cable screws to hold the connector in place.

### DP Port

The DP port is a digital display interface used to connect a display device such as a computer monitor. It is used to transmit audio and video simultaneously. The interface, which is developed by VESA, delivers higher performance features than any other digital interface.

### HDMI Port (optional)

The HDMI port which carries both digital audio and video signals is used to connect a LCD monitor or digital TV that has the HDMI port.

## BIOS Setting

Configure the display devices in the Chipset menu ("North Bridge Configuration" submenu) of the BIOS. Refer to the chapter 3 for more information.

## USB Ports

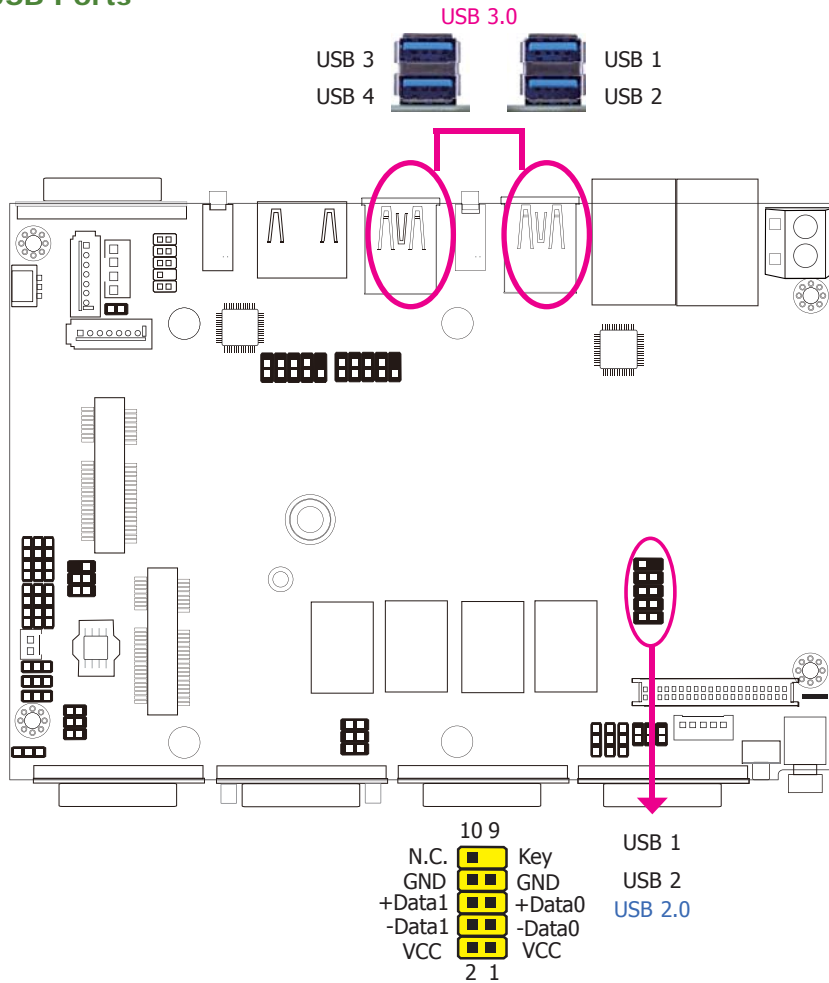

The USB device allows data exchange between your computer and a wide range of simultaneously accessible external Plug and Play peripherals.

The system board is equipped with four onboard USB 3.0 port (USB 1-4). The 10-pin connector allows you to connect 2 additional USB 2.0 port (USB 1-2). The additional USB port may be mounted on a card-edge bracket. Install the card-edge bracket to an available slot at the rear of the system chassis and then insert the USB port cables to a connector.

## BIOS Setting

Configure the onboard USB in the Advanced menu ("USB Configuration" submenu) of the BIOS. Refer to chapter 3 for more information.

## Driver Installation

You may need to install the proper drivers in your operating system to use the USB device. Refer to chapter 4 for more information.

## Wake-On-USB Keyboard/Mouse

The Wake-On-USB Keyboard/Mouse function allows you to use a USB keyboard or USB mouse to wake up a system from the S3 (STR - Suspend To RAM) state.



### Important:

If you are using the Wake-On-USB Keyboard/Mouse function for 2 USB ports, the +5V\_standby power source of your power supply must support  $\geq 1.5A$ . For 3 or more USB ports, the +5V\_standby power source of your power supply must support  $\geq 2A$ .

## COM (Serial) Ports

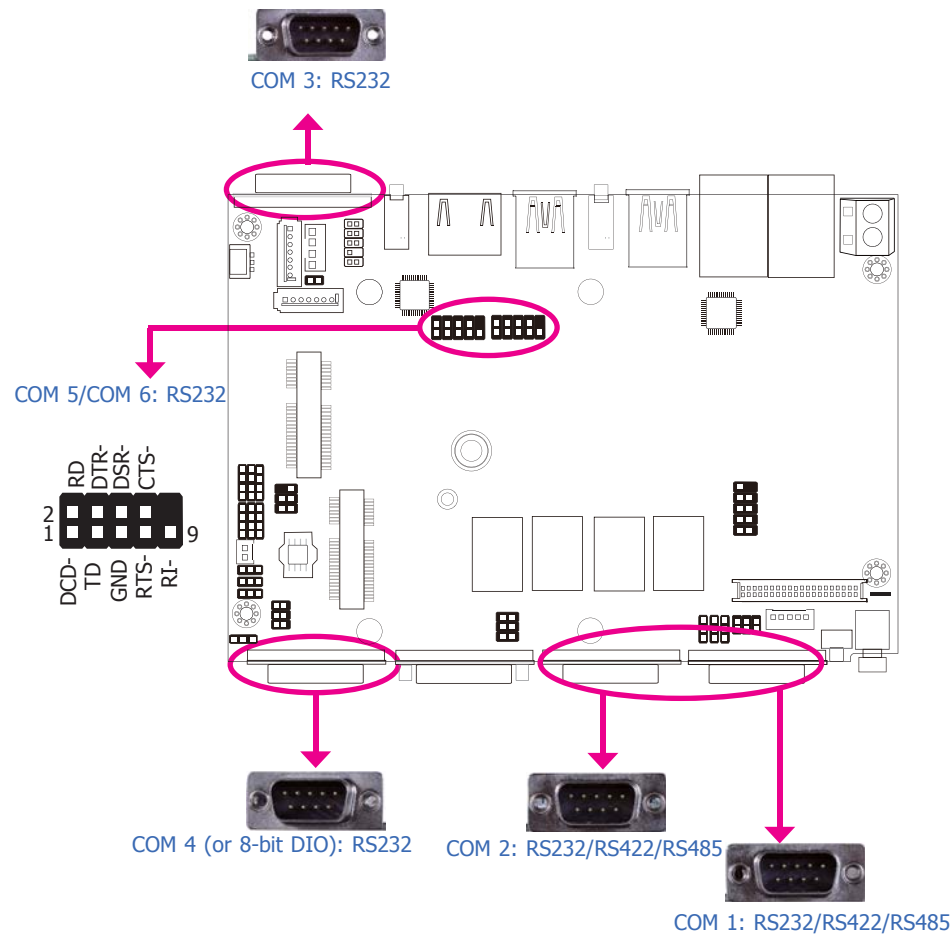

The serial ports are asynchronous communication ports with 16C550A-compatible UARTs that can be used with modems, serial printers, remote display terminals, and other serial devices.

### BIOS Setting

Configure the serial ports in the Integrated Peripherals submenu (“NCT6106D Super I/O Configuration” section) of the BIOS. Refer to chapter 3 for more information.

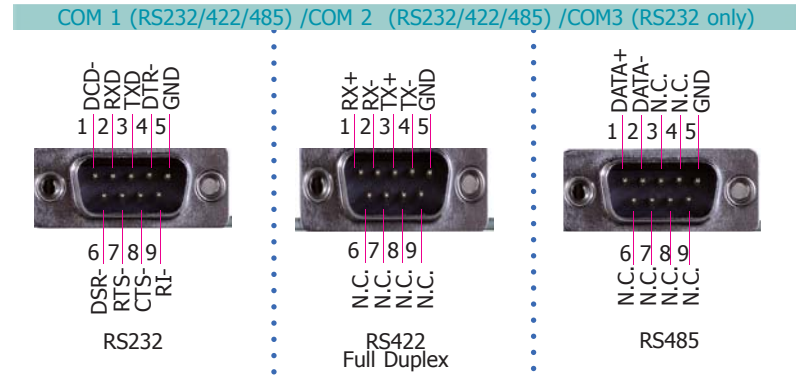

### COM 4 (Serial) Port

This DB-9 serial port can be used as a RS232 COM port or as an isolated 8-bit DIO via the jumper setting. Refer to “COM 4/DIO Select” in this section for its respective configuration.

### 8-bit DIO (4-bit in and 4-bit out)

The 8-bit Digital I/O connector provides powering-on function to external devices that are connected to the connector.

Pins	COM 4 Function	DIO Function
	RS232	
1	DCD	DIN0A
2	RX	DIN0B
3	TX	DIN1A
4	DTR	DIN1B
5	GND	GND
6	DSR	DOUT0A
7	RTS	DOUT0B
8	CTS	DOUT1A
9	RI	DOUT1B

## RJ45 LAN Ports

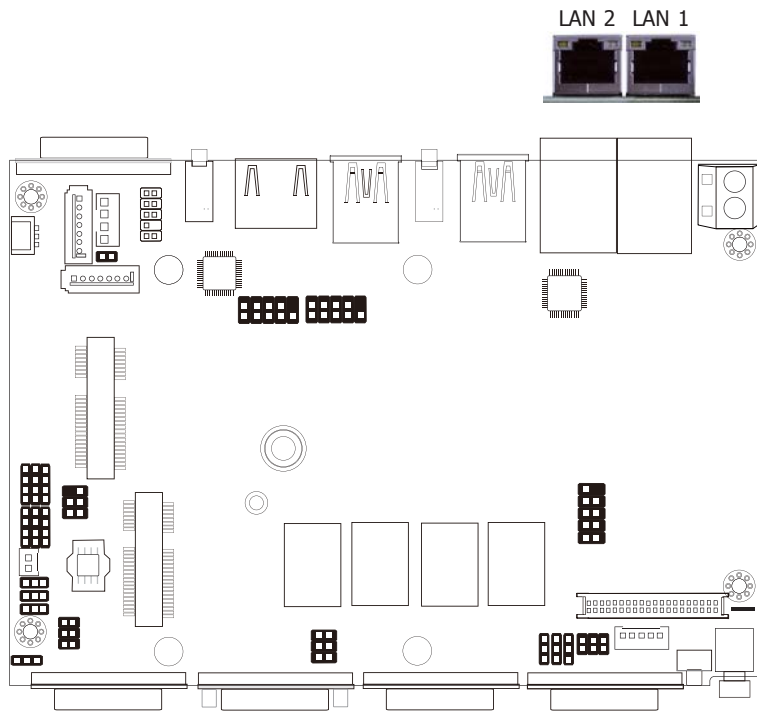

### Features

- 1 Intel® I210AT PCI Express Gigabit Ethernet controllers
- 1 Intel® I219LM PCI Express Gigabit Ethernet controllers

The LAN ports allow the system board to connect to a local area network by means of a network hub.

### Driver Installation

Install the LAN drivers. Refer to chapter 4 for more information.

## Audio

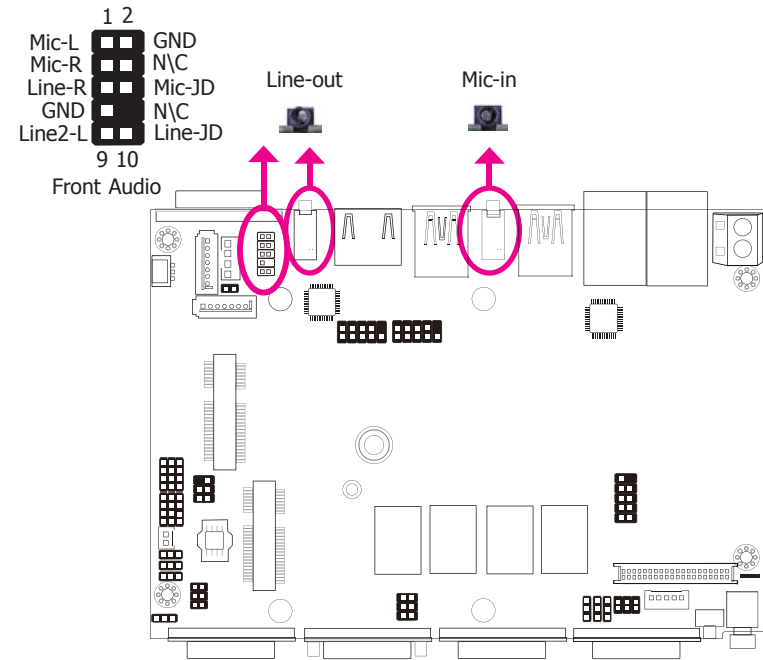

### Rear Audio

The system board is equipped with 2 audio jacks. A jack is a one-hole connecting interface for inserting a plug.

- Line-out Jack  
This jack is used to connect a headphone or external speakers.
- Mic-in Jack  
This jack is used to connect an external microphone.

### Front Audio

The front audio connector allows you to connect to the second line-out and mic-in jacks that are at the front panel of your system.

### Driver Installation

Install the audio driver. Refer to the chapter 4 for more information.

## I/O Connectors

### Serial ATA Connector

### Serial ATA Power Connector

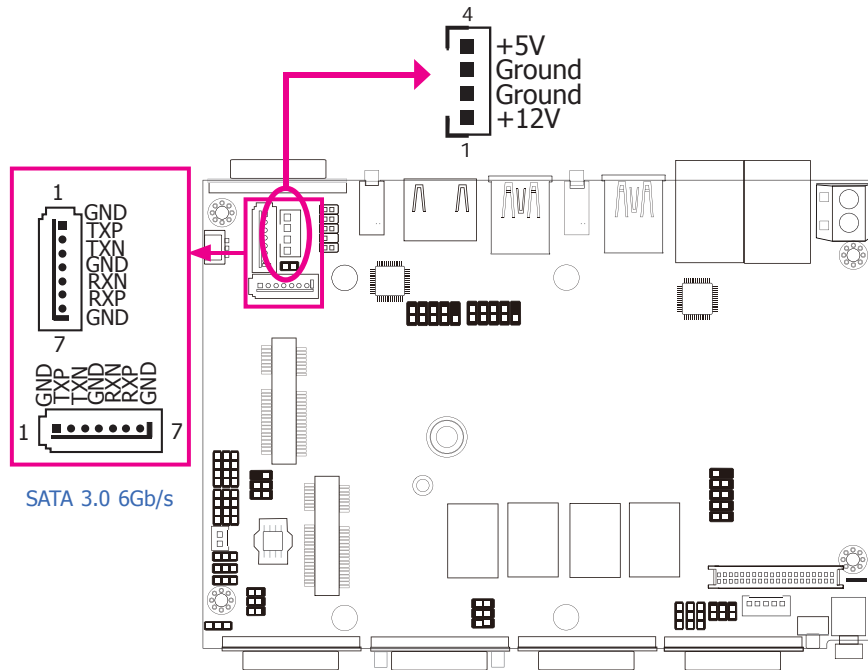

### Features

- 1 Serial ATA 3.0 port with data transfer rate up to 6Gb/s
- Integrated Advanced Host Controller Interface (AHCI) controller

The Serial ATA connector is used to connect the Serial ATA device. Connect one end of the Serial ATA data cable to a SATA connector and the other end to your Serial ATA device.

The SATA power connector supplies power to the SATA drive. Connect one end of the provided power cable to the SATA power connector and the other end to your storage device.

### BIOS Setting

Configure the Serial ATA drives in the Advanced menu ("SATA Configuration" submenu) of the BIOS. Refer to chapter 3 for more information.

## LVDS LCD Panel Connector

## LCD/Inverter Power Connector

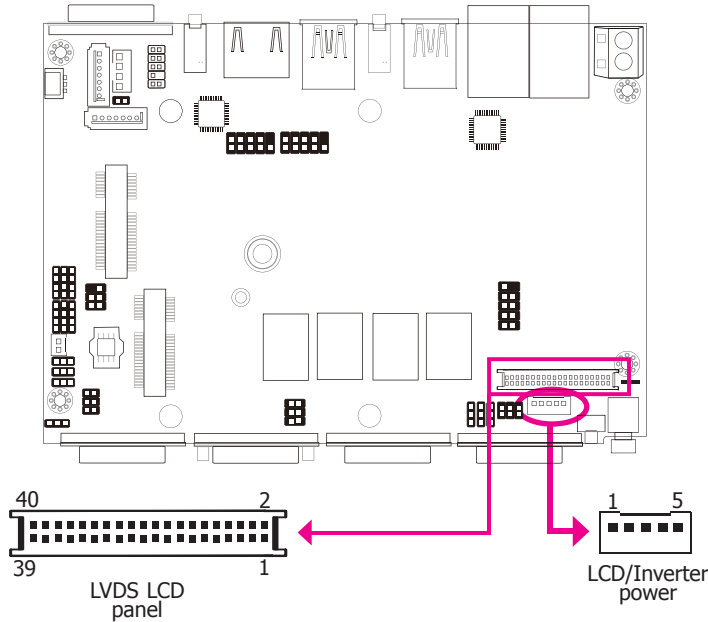

The system board allows you to connect a LCD Display Panel by means of the LVDS LCD panel connector and the LCD/Inverter power connector. These connectors transmit video signals and power from the system board to the LCD Display Panel.

Refer to the right side for the pin functions of these connectors.

### BIOS Setting

Configure the LCD panel in the Advanced menu ("Video Configuration" sub-menu) of the BIOS. Refer to the chapter 3 for more information.

## LVDS LCD Panel Connector

Pins	Function	Pins	Function
1	GND	2	GND
3	LVDS_Out3+ (Odd_3+)	4	LVDS_Out7+ (Even_3+)
5	LVDS_Out3- (Odd_3-)	6	LVDS_Out7- (Even_3-)
7	GND	8	GND
9	LVDS_Out2+ (Odd_2+)	10	LVDS_Out6+ (Even_2+)
11	LVDS_Out2- (Odd_2-)	12	LVDS_Out6- (Even_2-)
13	GND	14	GND
15	LVDS_Out1+ (Odd_1+)	16	LVDS_Out5+ (Even_1+)
17	LVDS_Out1- (Odd_1-)	18	LVDS_Out5- (Even_1-)
19	GND	20	GND
21	LVDS_Out0+ + (Odd_0+)	22	LVDS_Out4+ (Even_0+)
23	LVDS_Out0-+ (Odd_0-)	24	LVDS_Out4- (Even_0-)
25	GND	26	GND
27	LVDS_CLK1++ (Odd_CLK+)	28	LVDS_CLK2+(Even_CLK+)
29	LVDS_CLK1-+ (Odd_CLK-)	30	LVDS_CLK2- (Even_CLK-)
31	GND	32	GND
33	DDC_CLK	34	NC
35	DDC_DATA	36	+3.3V
37	Panel Power	38	Panel Power
39	Panel Power	40	Panel Power

## LCD/Inverter Power Connector

Pins	Function
1	+12V
2	GND
3	Panel Backlight On/Off Control
4	Dimming Control
5	+5V



### Note:

DFI board's LVDS connector: Hirose DF13-40DP-1.25V(91)/40P/1.25mm; cable side connector: Hirose DF13-40DS-1.25C.

## Cooling Fan Connector

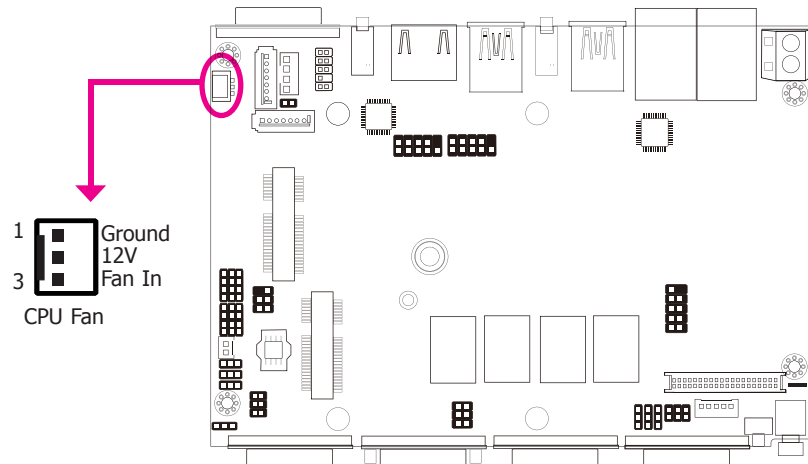

The fan connector is used to connect the cooling fan. The cooling fan will provide adequate airflow throughout the chassis to prevent overheating the CPU and system board components.

## BIOS Setting

The Advanced menu ("HW Monitor" submenu) of the BIOS will display the current speed of the cooling fans. Refer to chapter 3 for more information.

## Chassis Intrusion Connector

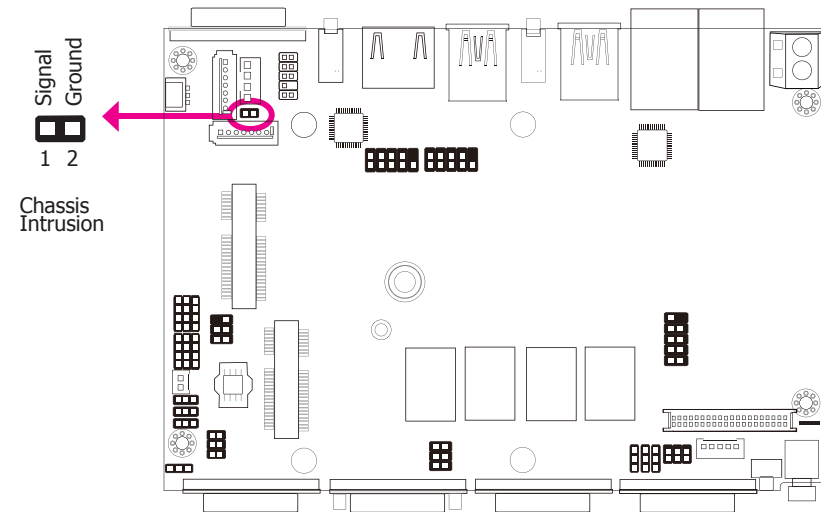

The board supports the chassis intrusion detection function. Connect the chassis intrusion sensor cable from the chassis to this connector. When the system's power is on and a chassis intrusion occurred, an alarm will sound. When the system's power is off and a chassis intrusion occurred, the alarm will sound only when the system restarts.



## Expansion Slots

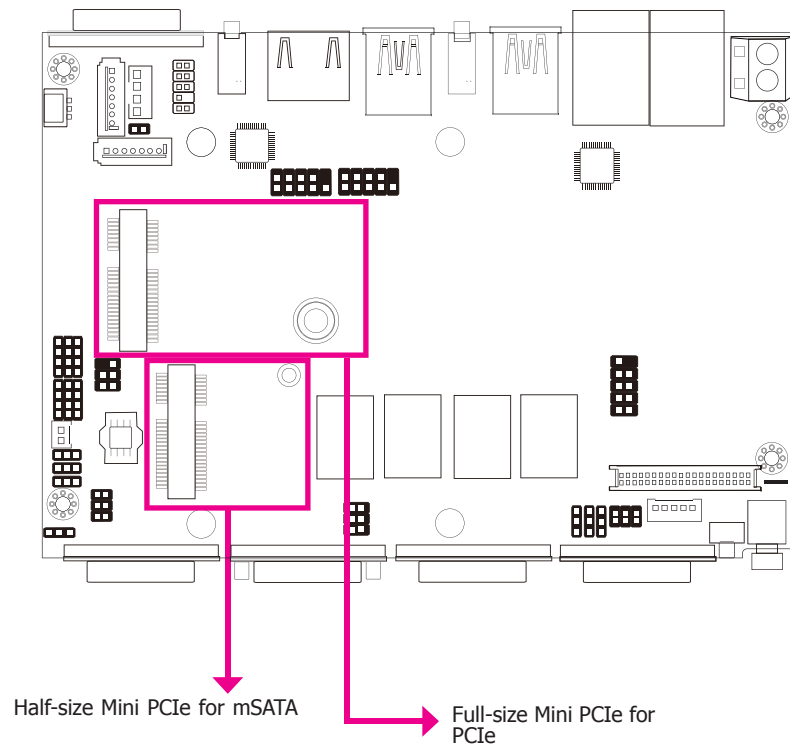

### Mini PCI Express Slots

The Mini PCI Express slots on the system board are used to install one half and/or full size Mini PCIe card such as network cards or other cards that comply to the mini PCI Express specifications into the mini PCI Express slot.

## SMBus Connector

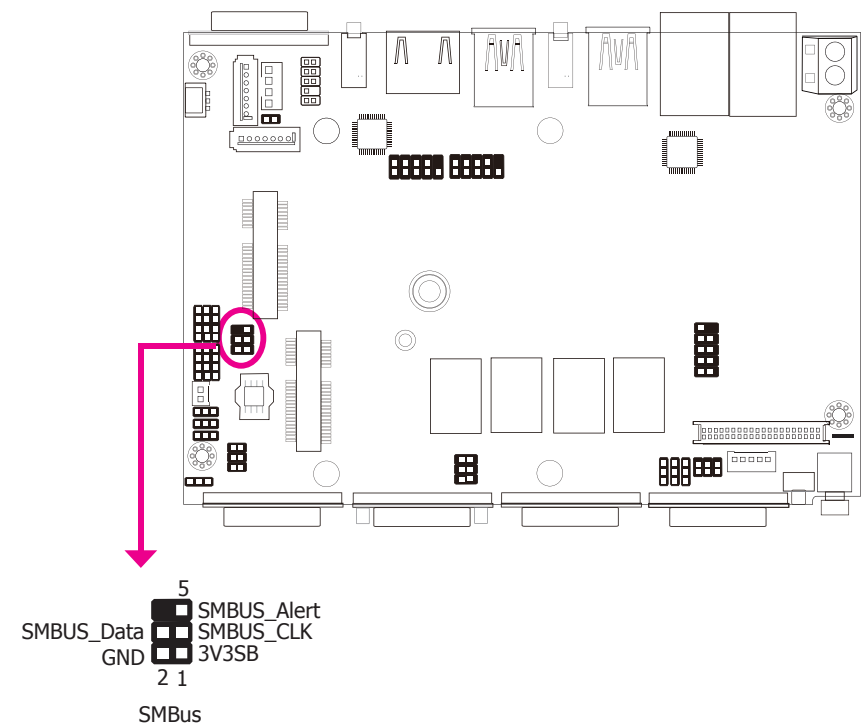

The SMBus (System Management Bus) connector is used to connect SMBus devices. It is a multiple device bus that allows multiple chips to connect to the same bus and enable each one to act as a master by initiating data transfer.

## Front Panel Connector

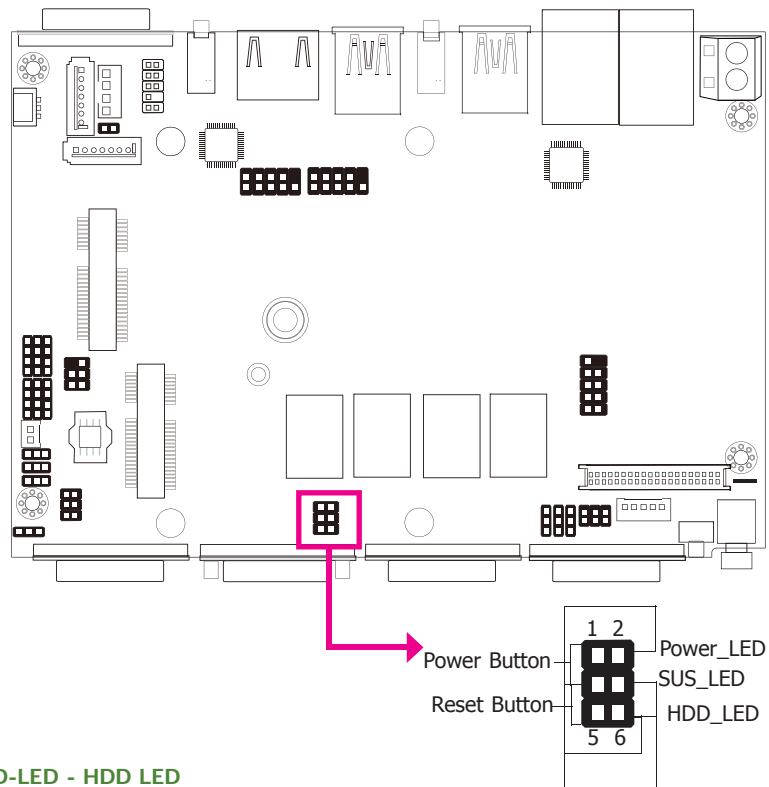

### HDD-LED - HDD LED

This LED will be lit when the hard drive is being accessed.

### RESET-SW - Reset Switch

This switch allows you to reboot without having to power off the system.

### PWR-BTN - Power Switch

This switch is used to power on or off the system.

### PWR-LED - Power/Standby LED

When the system's power is on, this LED will be lit. When the system is in the S1 (POS - Power On Suspend) state, it will blink every second. When the system is in the S3 (STR - Suspend To RAM) state, it will blink every 4 seconds.

	Pin	Pin Assignment		Pin	Pin Assignment
HDD-LED	6	HDD Power	PWR Button	1	Power Button
	3	Ground		3	Ground
RESET-SW	3	Ground	PWR LED	2	Power LED
	5	RST Signal		3	Ground
			Suspend Mode LED	3	Ground
				4	SUS LED

## Standby Power LED

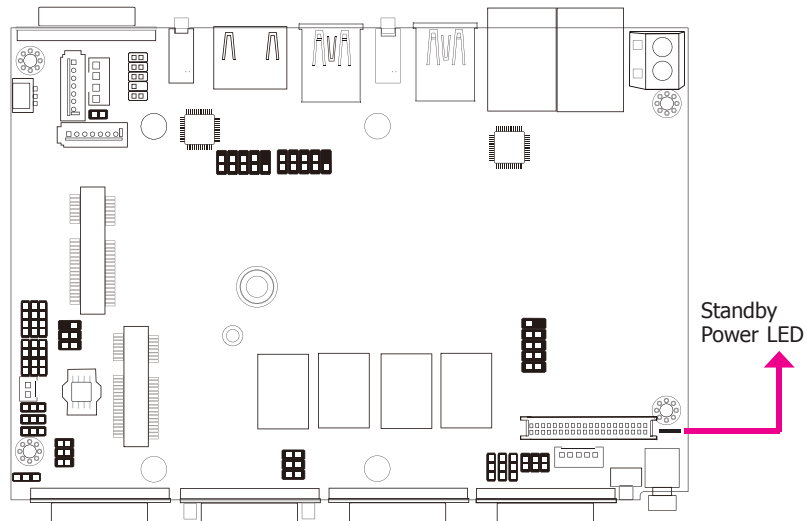

This LED will blink when the system is in the standby mode. It indicates that there is power on the system board. Power-off the PC and then unplug the power cord prior to installing any devices. Failure to do so will cause severe damage to the motherboard and components.

## Battery

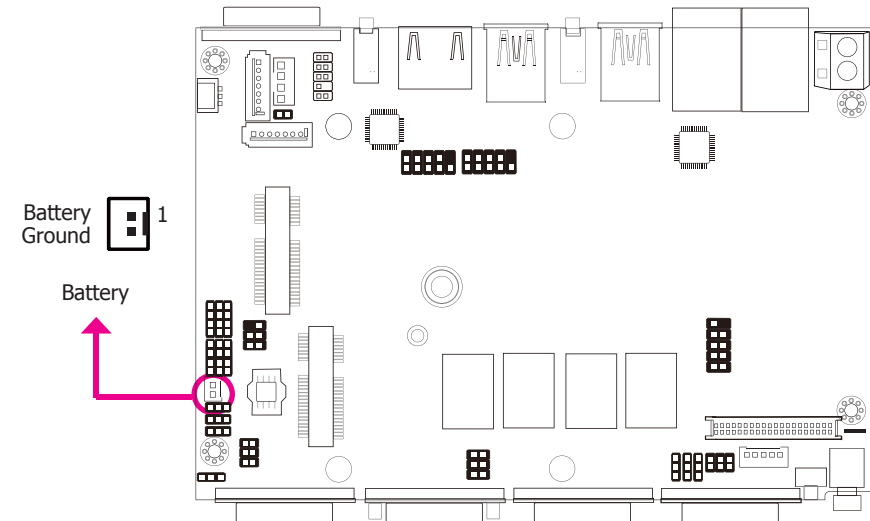

The lithium ion battery powers the real-time clock and CMOS memory. It is an auxiliary source of power when the main power is shut off.

### Safety Measures

- Danger of explosion if battery incorrectly replaced.
- Replace only with the same or equivalent type recommend by the manufacturer.
- Dispose of used batteries according to local ordinance.

## Chapter 3 - BIOS Setup

### Overview

The BIOS is a program that takes care of the basic level of communication between the CPU and peripherals. It contains codes for various advanced features found in this system board. The BIOS allows you to configure the system and save the configuration in a battery-backed CMOS so that the data retains even when the power is off. In general, the information stored in the CMOS RAM of the EEPROM will stay unchanged unless a configuration change has been made such as a hard drive replaced or a device added.

It is possible that the CMOS battery will fail causing CMOS data loss. If this happens, you need to install a new CMOS battery and reconfigure the BIOS settings.



**Note:**

The BIOS is constantly updated to improve the performance of the system board; therefore the BIOS screens in this chapter may not appear the same as the actual one. These screens are for reference purpose only.

### Default Configuration

Most of the configuration settings are either predefined according to the Load Optimal Defaults settings which are stored in the BIOS or are automatically detected and configured without requiring any actions. There are a few settings that you may need to change depending on your system configuration.

### Entering the BIOS Setup Utility

The BIOS Setup Utility can only be operated from the keyboard and all commands are keyboard commands. The commands are available at the right side of each setup screen.

The BIOS Setup Utility does not require an operating system to run. After you power up the system, the BIOS message appears on the screen and the memory count begins. After the memory test, the message "Press DEL to run setup" will appear on the screen. If the message disappears before you respond, restart the system or press the "Reset" button. You may also restart the system by pressing the <Ctrl> <Alt> and <Del> keys simultaneously.

### Legends

Keys	Function
Right and Left arrows	Moves the highlight left or right to select a menu.
Up and Down arrows	Moves the highlight up or down between submenu or fields.
<Esc>	Exit to the BIOS Setup Utility.
<F1>	Help
<F5>	Change values
<F6>	Change values
<F9>	Setup Defaults
<F10>	Save and Exit
<Enter>	Press <Enter> to enter the highlighted submenu.

### Scroll Bar

When a scroll bar appears to the right of the setup screen, it indicates that there are more available fields not shown on the screen. Use the up and down arrow keys to scroll through all the available fields.

### Submenu

When "►" appears on the left of a particular field, it indicates that a submenu which contains additional options are available for that field. To display the submenu, move the highlight to that field and press <Enter>.

## Insyde BIOS Setup Utility

### Main

The Main menu is the first screen that you will see when you enter the BIOS Setup Utility.



#### System Time

The time format is <hour>, <minute>, <second>. The time is based on the 24-hour military-time clock. For example, 1 p.m. is 13:00:00. Hour displays hours from 00 to 23. Minute displays minutes from 00 to 59. Second displays seconds from 00 to 59.

#### System Date

The date format is <month>, <date>, <year>. Month displays the month, from January to December. Date displays the date, from 1 to 31. Year displays the year, from 1980 to 2099.

### Advanced

The Advanced menu allows you to configure your system for basic operation. Some entries are defaults required by the system board, while others, if enabled, will improve the performance of your system or let you set some features according to your preference.



#### Important:

Setting incorrect field values may cause the system to malfunction.

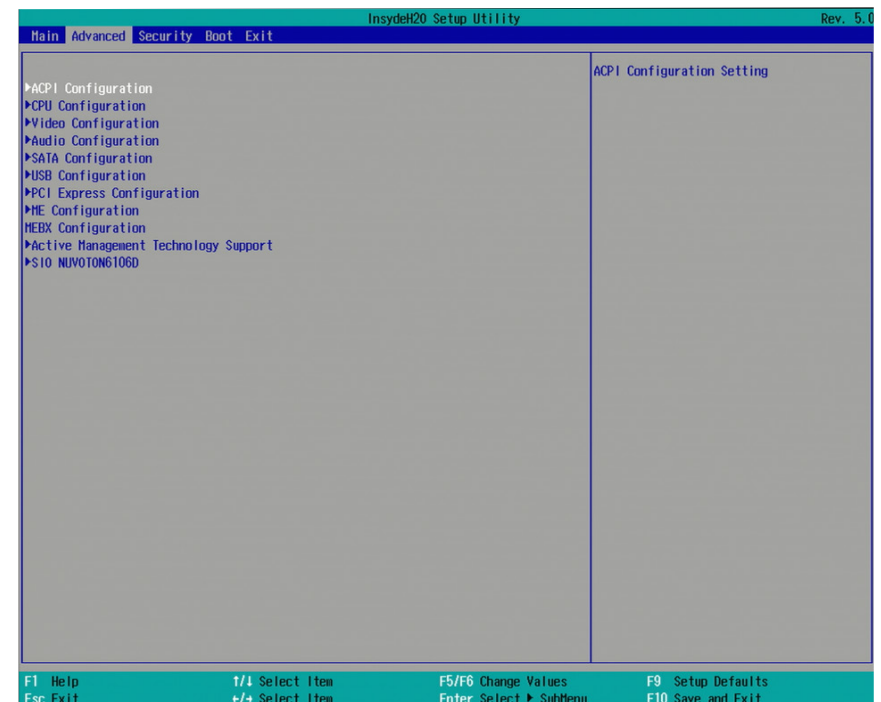

## ACPI Settings

This section is used to configure the system ACPI parameters.



### Wake on LAN

This field use to enable or disable the LAN signal to wake up the system.

### After G3

This field is to specify what state to go when power is re-applied after a power failure (G3 state).

**S0 State** The system working state.

**S5 State** System off, except for trickle current to devices such as the power button.

## CPU Configuration

This section is used to configure the CPU.

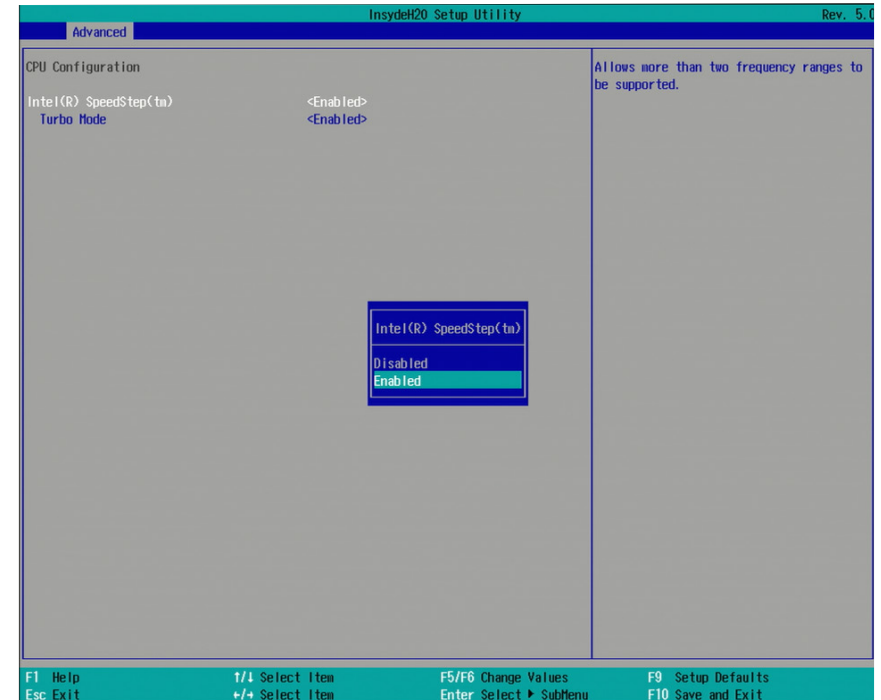

### Intel(R) SpeedStep(tm)

This field is used to enable or disable the Intel Enhanced SpeedStep Technology.

### Turbo Mode

This field is used to enable or disable processor turbo mode.

### Video Configuration

This section configures the video settings.

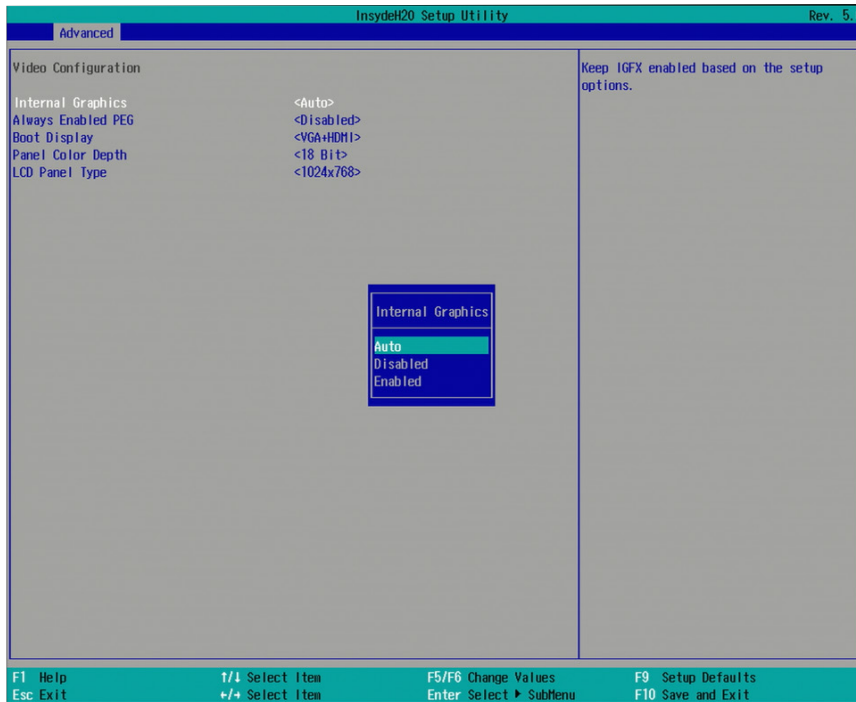

#### Internal Graphics

Keep IGFX enabled or disabled based on the setup options.

#### Always Enabled PEG

Enable or disable the PEG function.

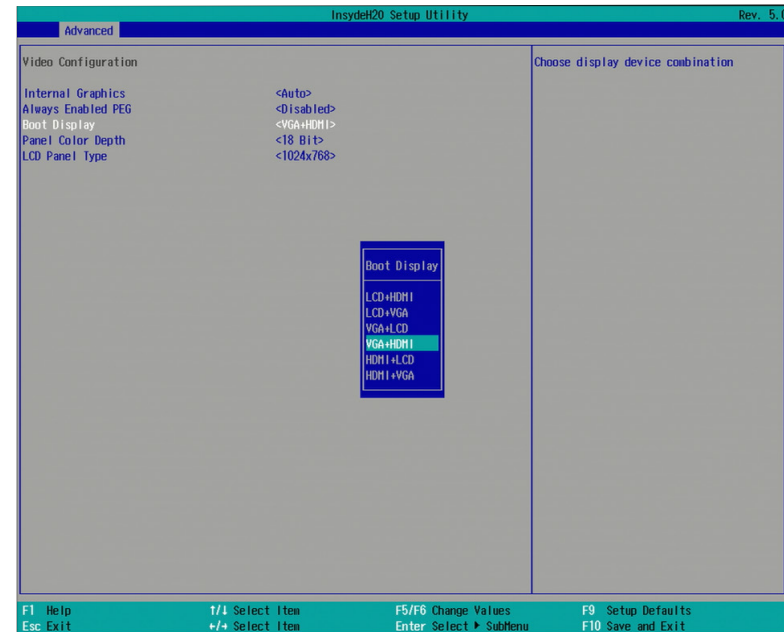

Set the display device combination. If the board is equipped with an eDP port, the following screen is displayed instead.

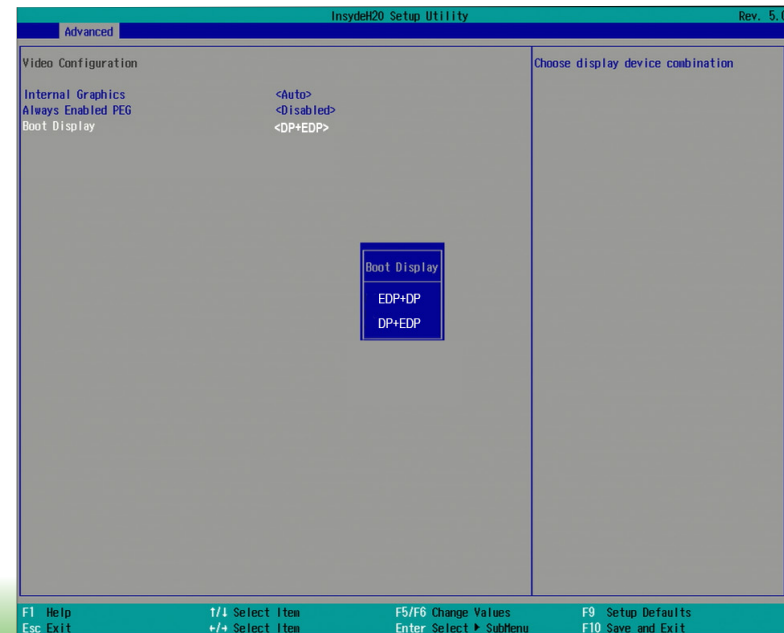

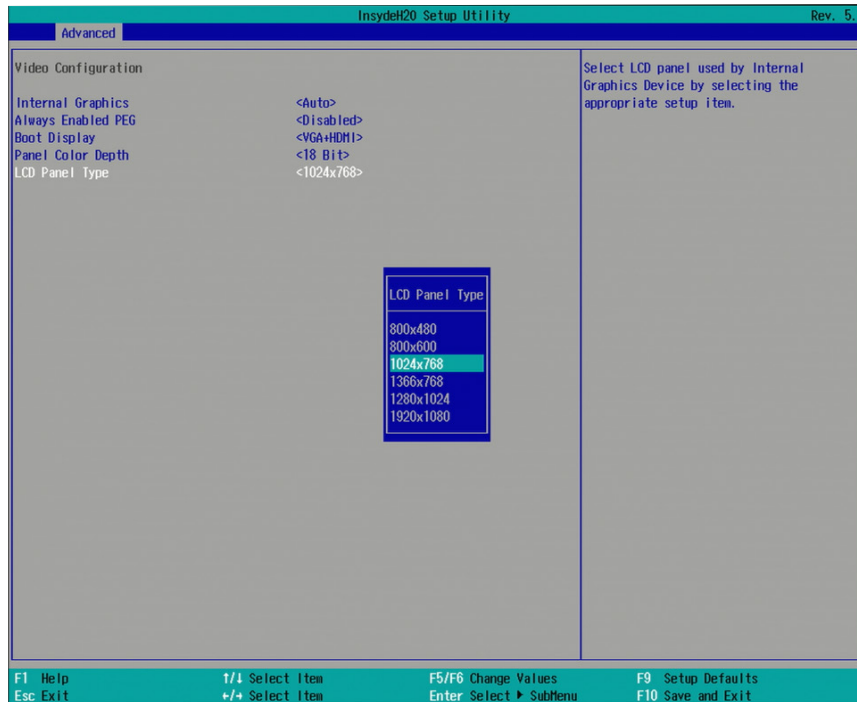

### Panel Color Depth

Select the LFP panel color depth: 18 bit, 24 bit, 36 bit, and 48 bit.

### LCD Panel Type

Select the LCD panel type.

## Audio Configuration

This section is used to configure the audio settings.

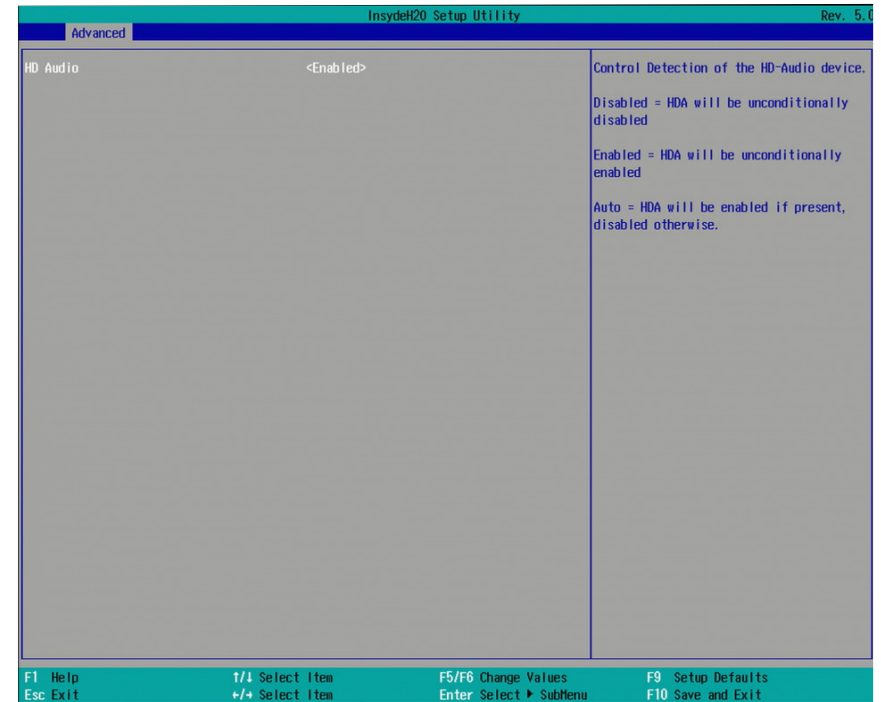

### HD Audio

Control the detection of the HD-Audio device.

#### Disabled

HD Audio will be unconditionally disabled.

#### Enabled

HD Audio will be unconditionally enabled.

#### Auto

HD Audio will be enabled if present and disabled otherwise.



## SATA Configuration

This section is designed to select the SATA controller and the type of hard disk drives which are installed in your system unit.

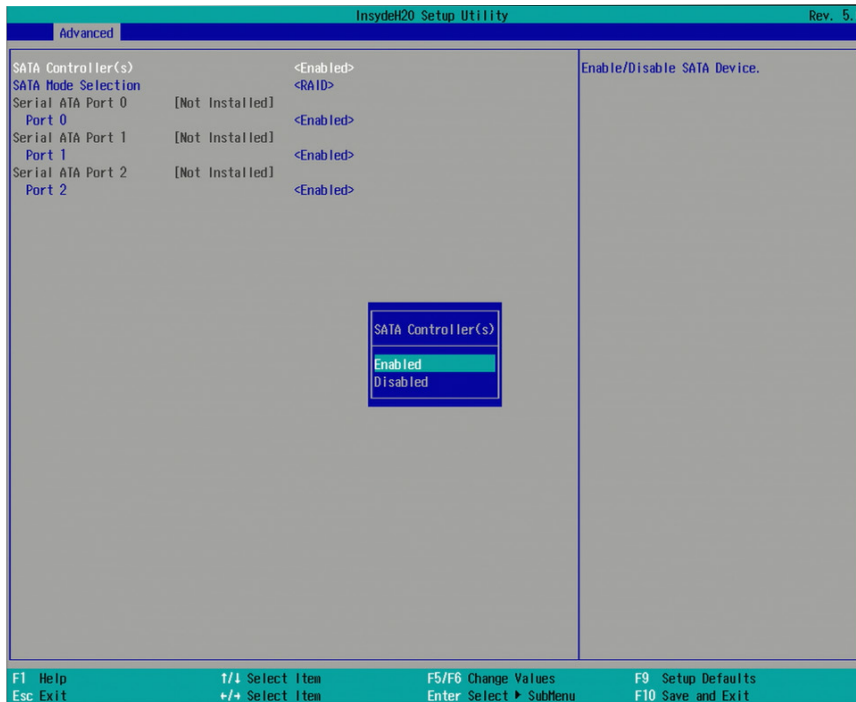

### SATA Controller(s)

This field is used to enable or disable Serial ATA devices.

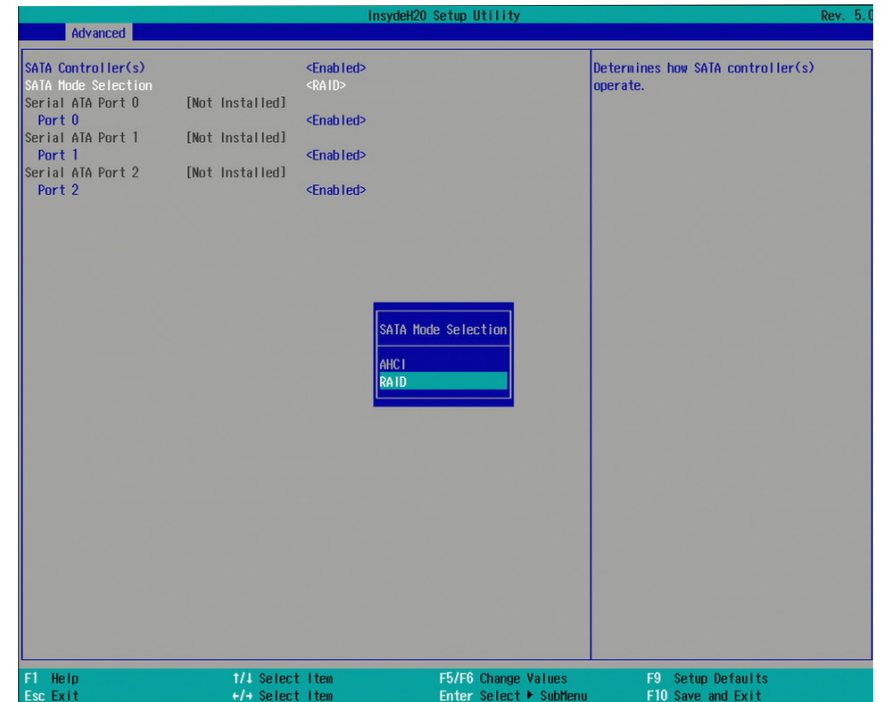

### SATA Mode Selection

The mode selection determines how the SATA controller(s) operates.

#### AHCI Mode

This option allows the Serial ATA devices to use AHCI (Advanced Host Controller Interface).

#### RAID Mode

This option allows you to create RAID or Intel Matrix Storage configuration on Serial ATA devices.

### Serial ATA Port 0, 1, and 2

This field is used to enable or disable the serial ATA port.

## USB Configuration

This section is used to configure the parameters of the USB device.

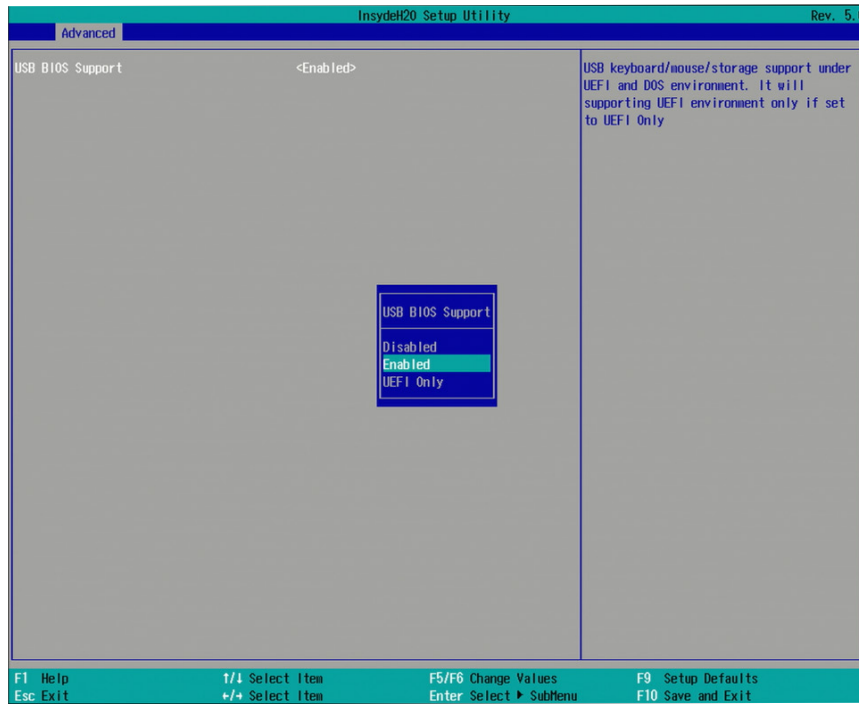

### USB BIOS Support

#### Disabled

Disable USB keyboard/mouse/storage support.

#### Enabled

Enable USB keyboard/mouse/storage support under UEFI and DOS environment.

## PCI Express Configuration

This section configures settings relevant to PCI Express root ports.

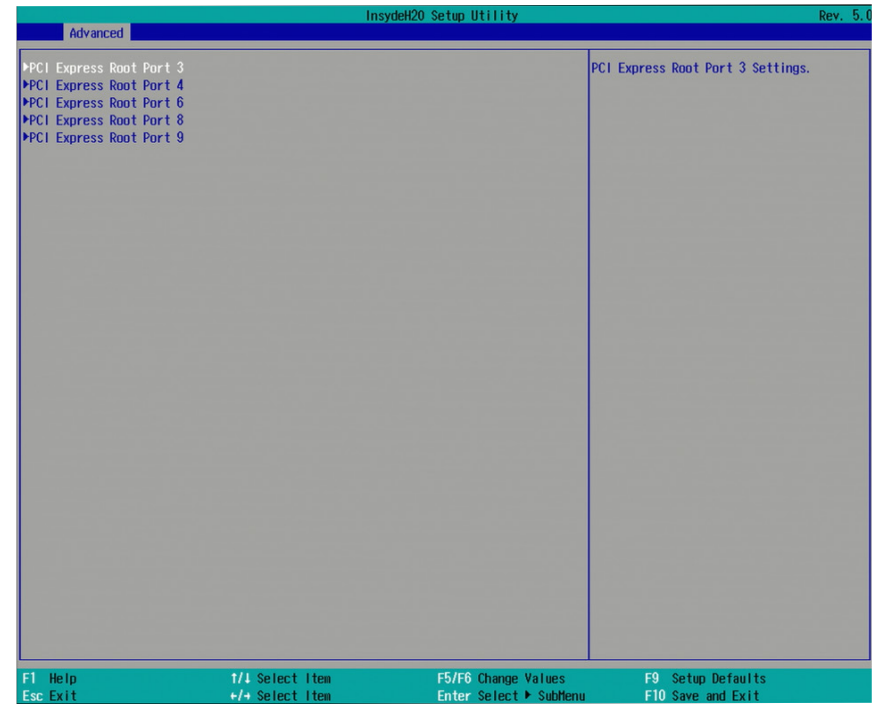

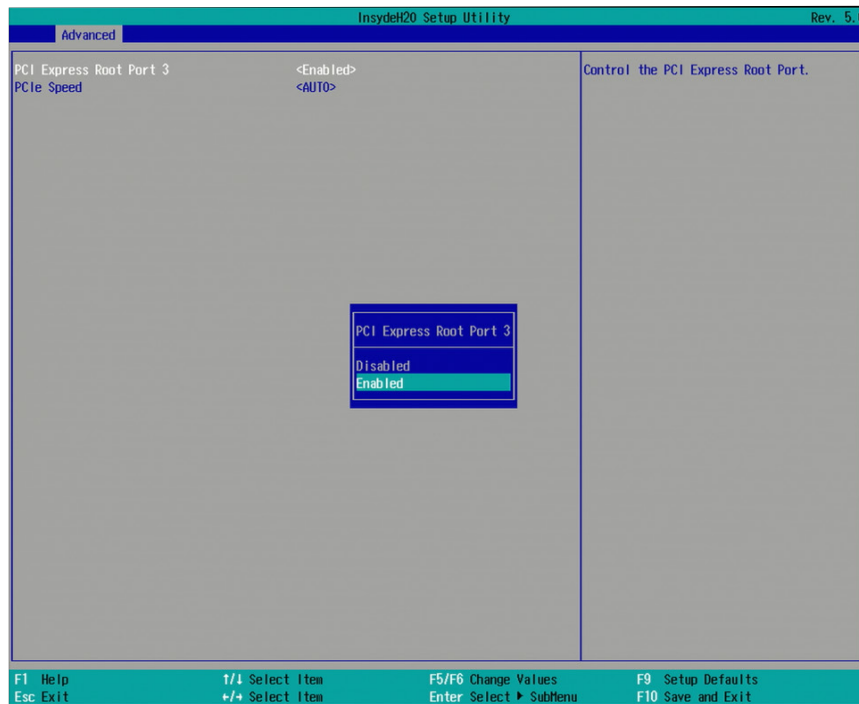

### PCI Express Root Port

This field is used to enable or disable the PCI Express Root Port.

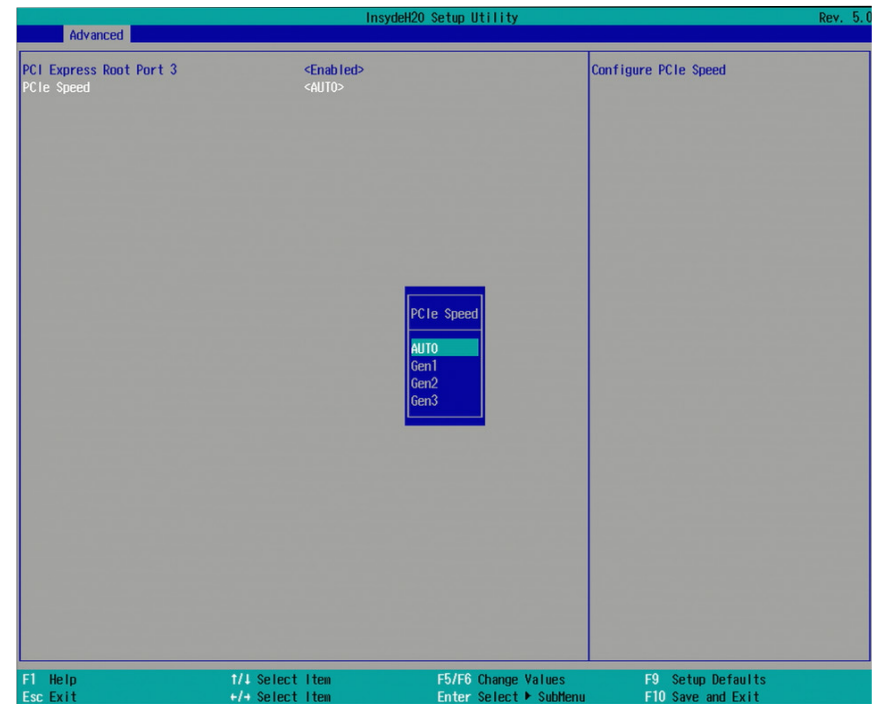

### PCIe Speed

Select the speed of the PCI Express Root Port: Auto, Gen1, Gen2 or Gen3.

## ME Configuration

This section configures settings on flashing Intel ME region.

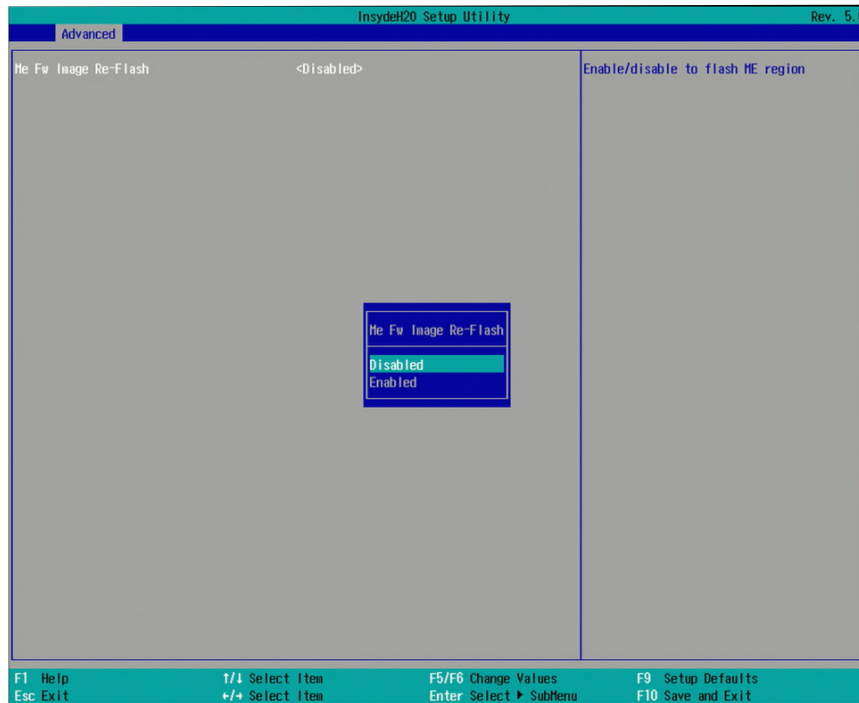

### Me Fw Image Re-Flash

This field is used to enable or disable flashing the Intel Management Engine region.

## Active Management Technology Support

The section allows users to enable or disable the Intel® Active Management Technology (Intel® AMT) BIOS extension. Refer to chapter 6 for more information.

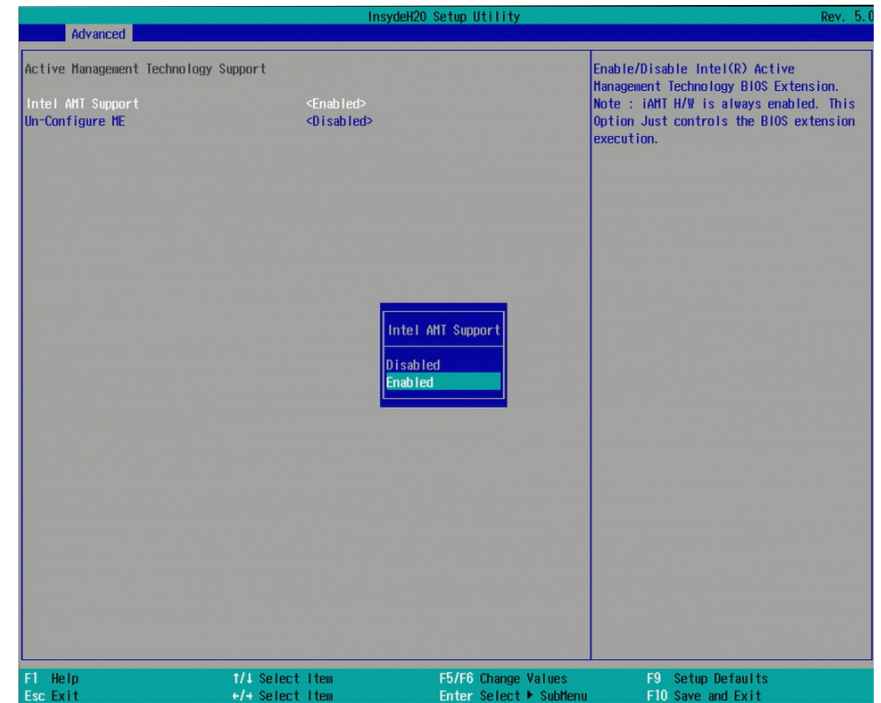

### Intel AMT Support

This field is used to enable or disable Intel® Active Management Technology BIOS extension.

### Un-Configure ME

This field is used to un-configure ME without password.

## SIO NUVOTON6106D

This section configures the system super I/O chip parameters.

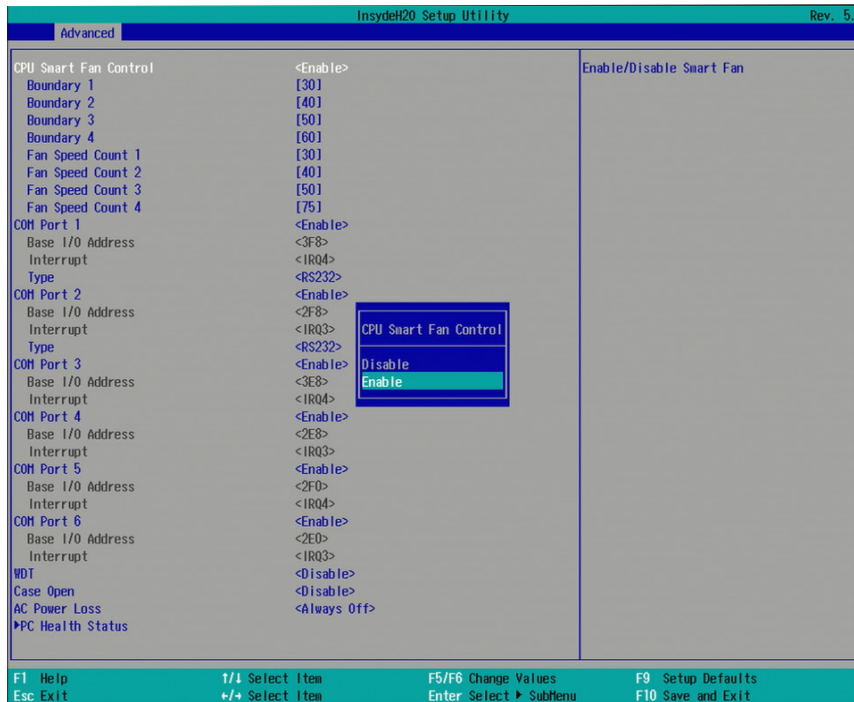
**CPU Smart Fan Control**

Enable or disable the CPU smart fan.

**Boundary 1 to Boundary 4**

Set the boundary temperature. The range is from 0-127°C.

**Fan Speed Count 1 to Fan Speed Count 4**

Set the fan speed. The range is from 1-100%.

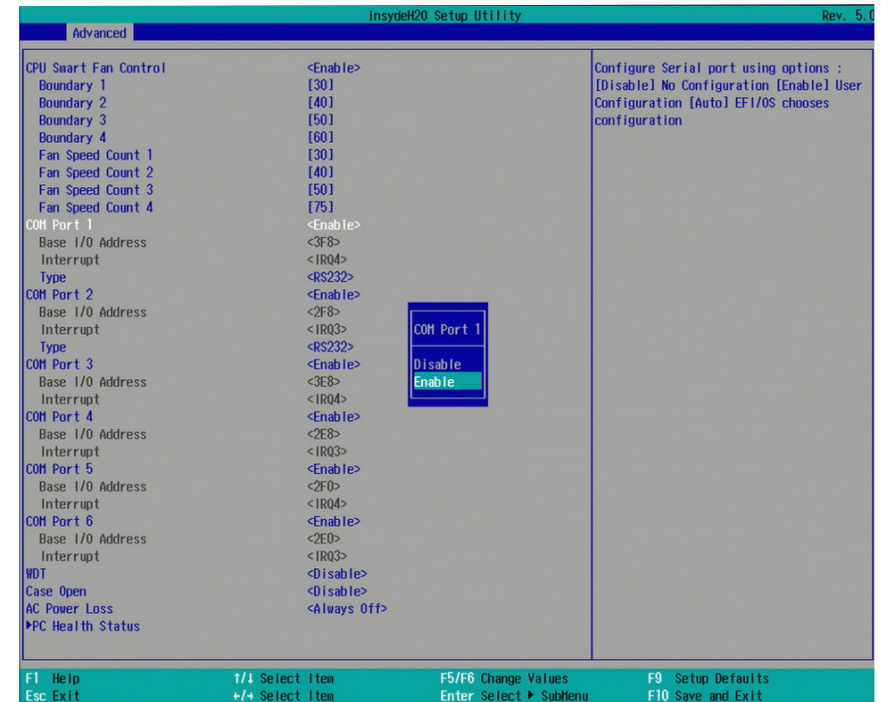
**COM Port 1 to COM Port 6**

Configure the settings to use the serial port.

**Disable** No configuration

**Enable** User configuration

**Type**

Choose RS232/RS422/RS485 for the COM port type.

## PC Health Status

This field only displays the PC health status information.

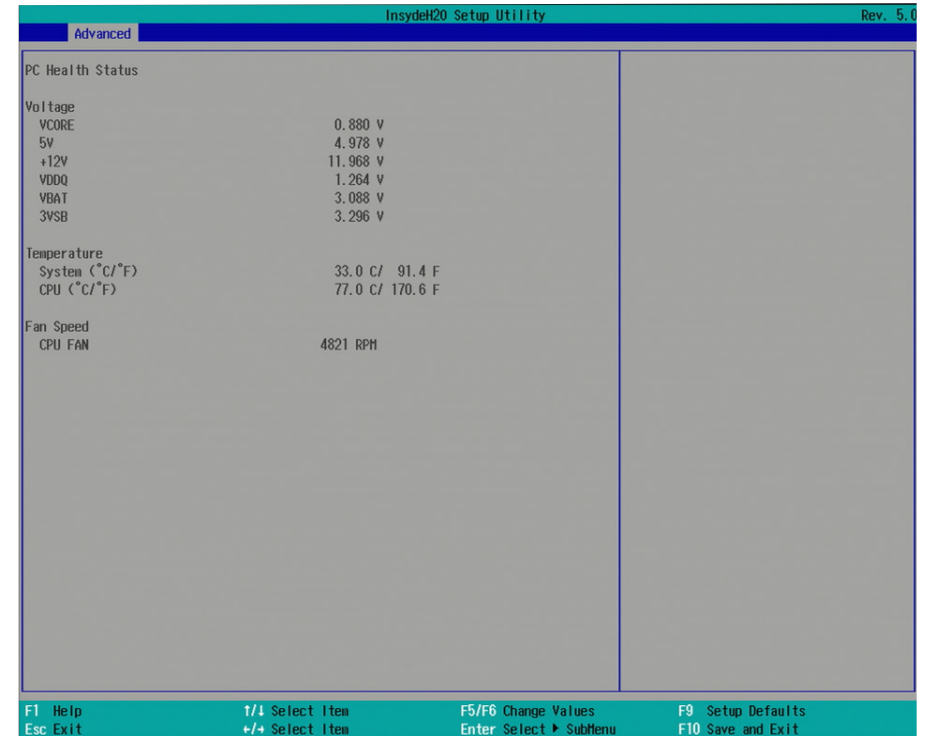

### WDT

Enable or disable the watchdog function. A counter will appear if you select to enable WDT. Input any value between 1 to 255.

### Case Open

Enable or disable the case open.

### AC Power Loss

Set the AC power loss to always off or always on.

## Security

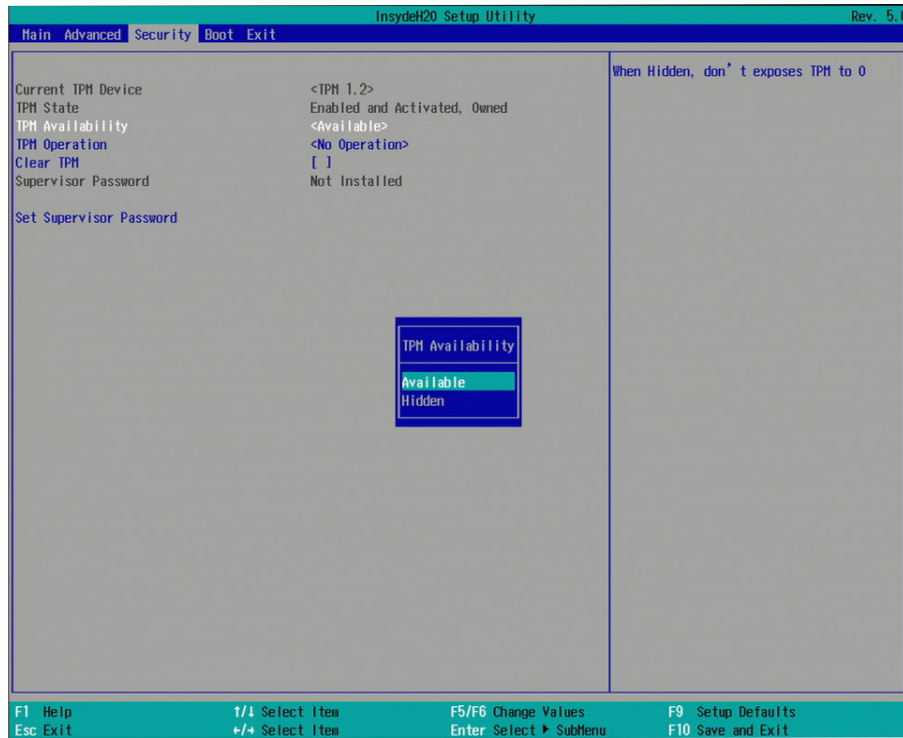

### TPM Availability

Set the TPM availability.

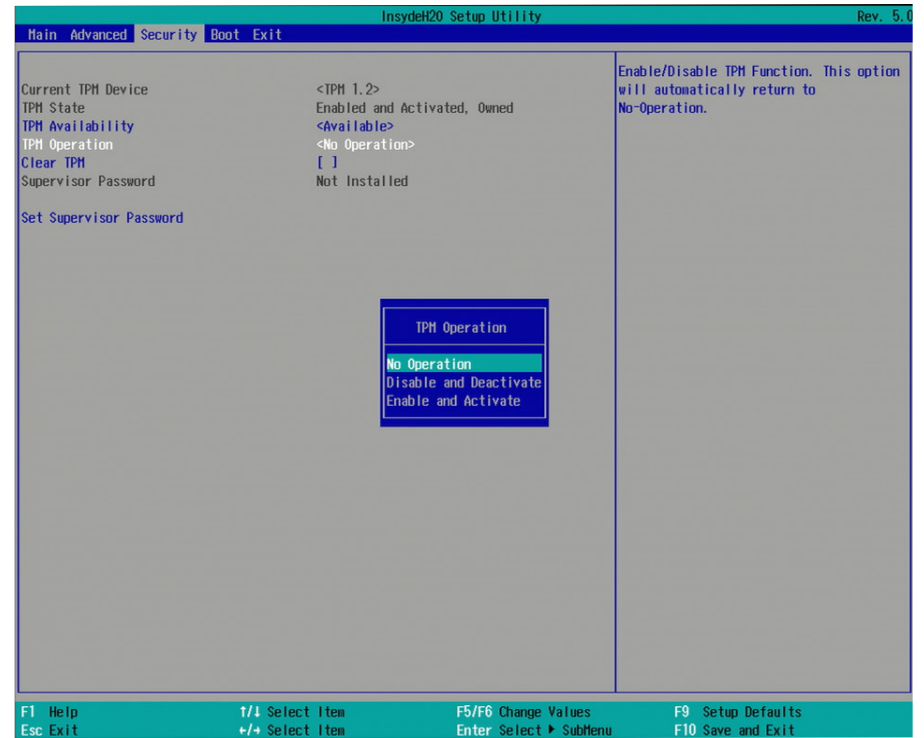

### TPM Operation

Enable or disable TPM function. This option will automatically return to No-Operation.

### Clear TPM

Remove all TPM context associated with a specific owner.

### Set Supervisor Password

Set the supervisor's password and the length of the password must be greater than one character.

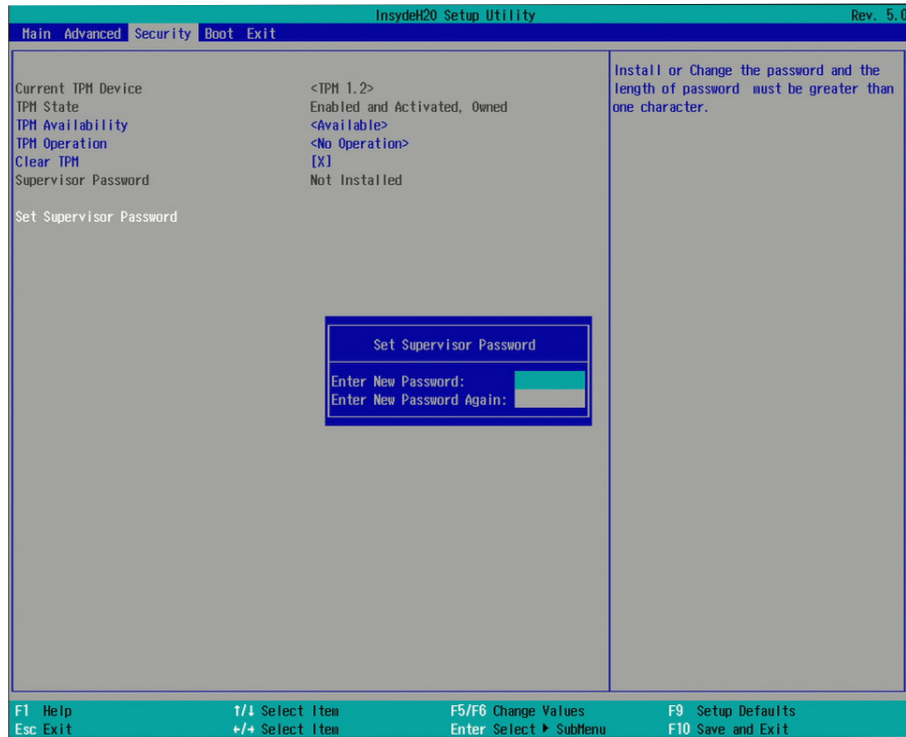



## Boot

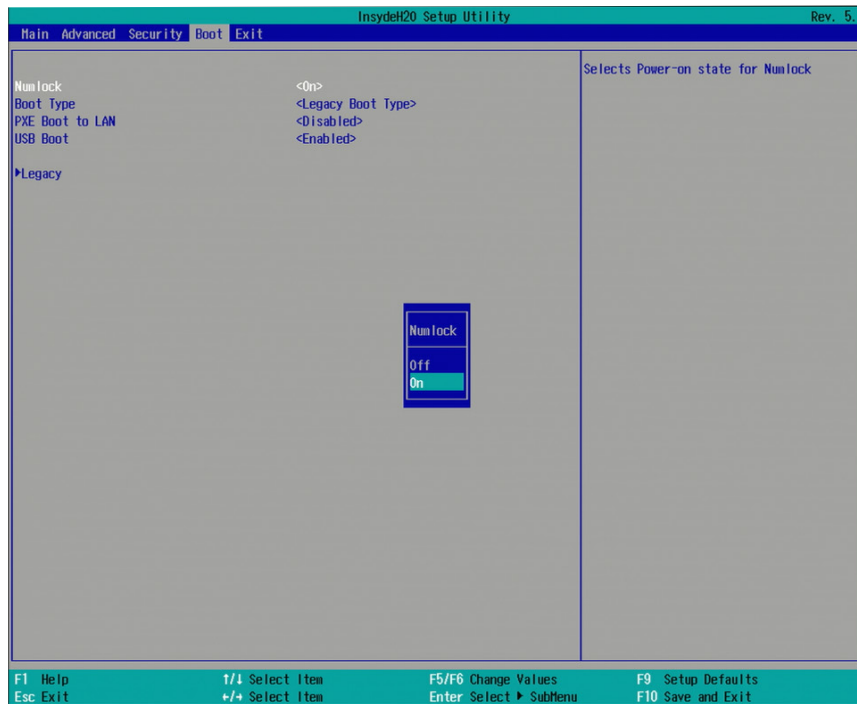

### Numlock

Select the power-on state for numlock.

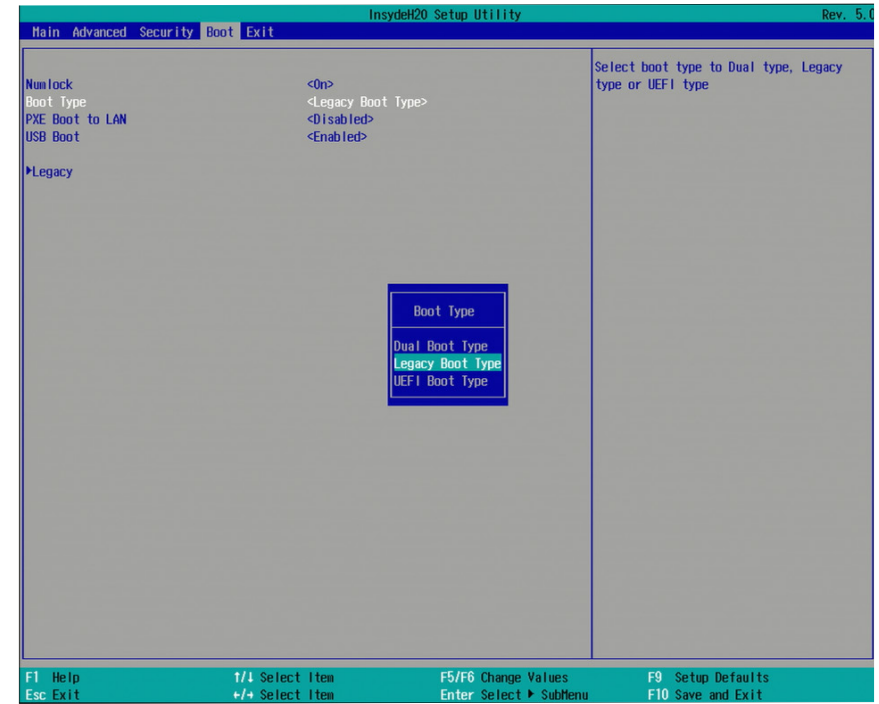

### Numlock

Select the power-on state for numlock.

### Boot Type

Select the boot type. The options are Dual Boot Type, Legacy Boot Type or UEFI Boot Type.

### PXE Boot to LAN

Disable or enable PXE boot to LAN.

### USB Boot

Enable or disable booting to USB boot devices.



#### Note:

If the boot type is set to UEFI, the method for RAID volume creation will be different. Please refer to Chapter 5 – RAID for more information.

## Legacy

This section is used to set legacy boot order.

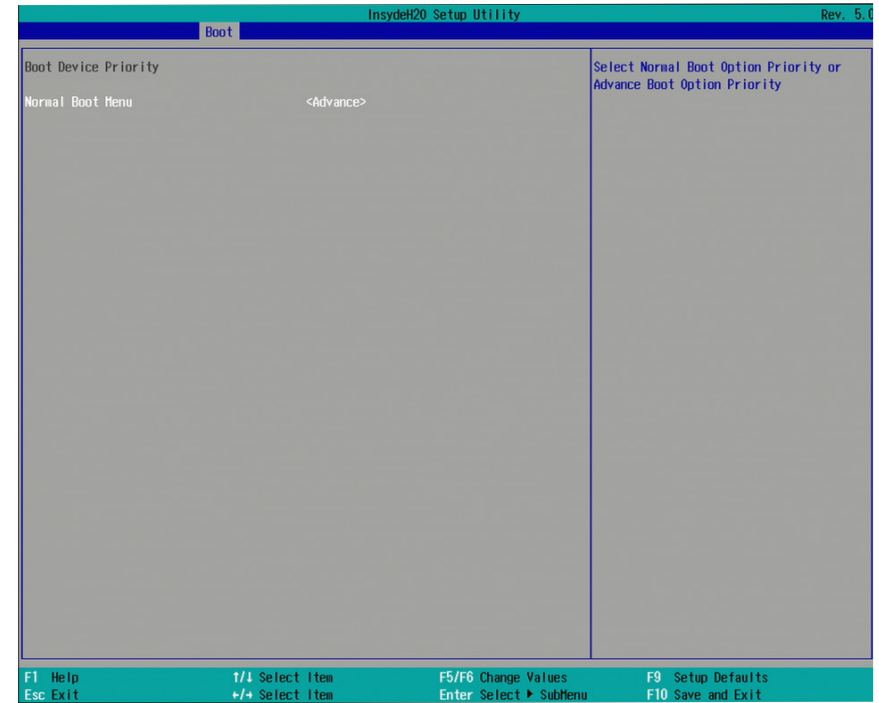
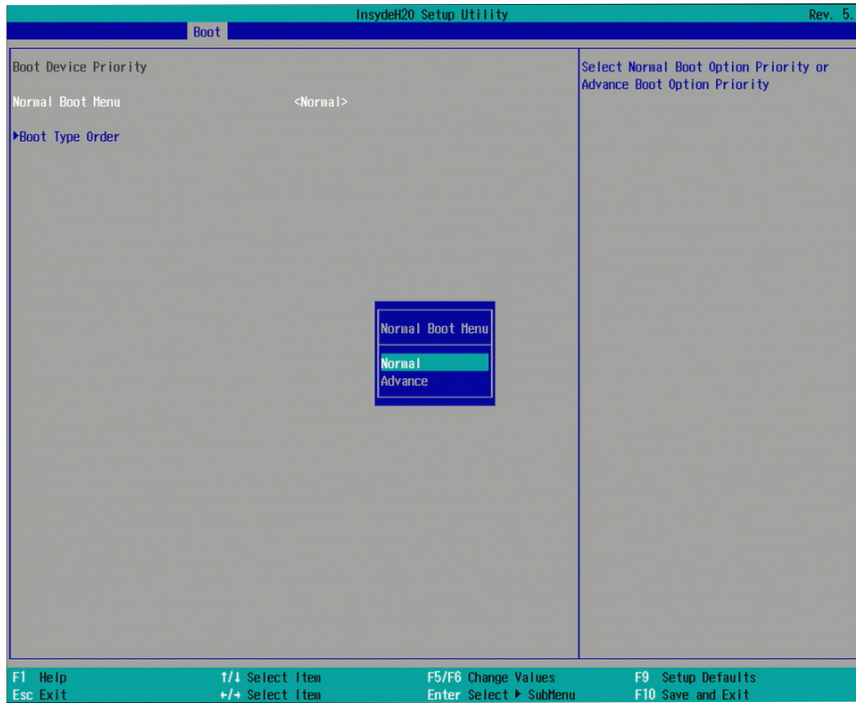

### Normal Boot Menu

#### Normal

Based on the boot normal priority, it determines the EFI device first or the legacy device first.

#### Advance

All boot devices follow the user's selection sequence.

### Boot Type Order

Select the priority of boot type: Normal Boot or Advance Boot.

## Exit

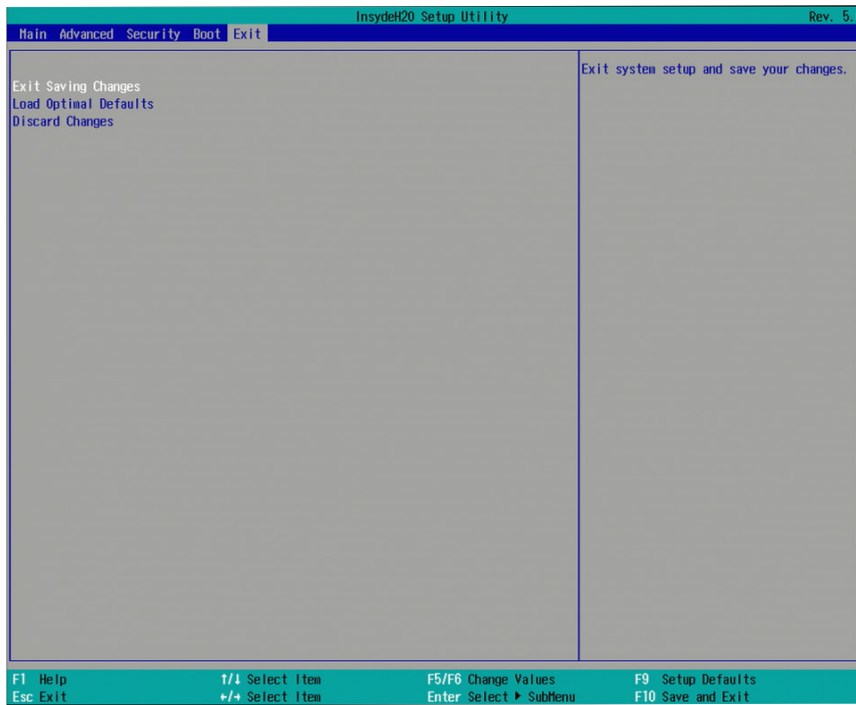

### Exit Saving Changes

Select this field and then press <Enter> to exit the system setup and save your changes.

### Load Optimal Defaults

Select this field and then press <Enter> to load optimal defaults.

### Discard Changes

Select this field and then press <Enter> to exit the system setup without saving your changes.

## Updating the BIOS

To update the BIOS, you will need the new BIOS file and a flash utility. Please contact technical support or your sales representative for the files and specific instructions about how to update BIOS with the flash utility.

When you download the given BIOS file, you may find a BIOS flash utility attached with the BIOS file. This is the utility for performing BIOS updating procedure. For your convenience, we will also provide you with an auto-execution file in the BIOS file downloaded. This auto-execution file will bring you directly to the flash utility menu soon after system boots up and finishes running the boot files in your boot disk.

```

Read file successfully. (path= "platform.ini")

Information
Please do not remove the AC power

Insyde H20FFT (Flash Firmware Tool) Version (SEG) 100.00.08.10
Copyright(c) 2012 - 2016, Insyde Software Corp. All Rights Reserved.

Initializing
Current BIOS Model name: SU25x
New BIOS Model name: SU25x

Current BIOS version: 68.08A
New BIOS version: 68.08A

Updating Block at FFFFF000h
0%      25%      50%      75%      100%
|-----|-----|-----|-----|
C:\SU25x>_

```

## Notice: BIOS SPI ROM

1. The Intel® Management Engine has already been integrated into this system board. Due to the safety concerns, the BIOS (SPI ROM) chip cannot be removed from this system board and used on another system board of the same model.
2. The BIOS (SPI ROM) on this system board must be the original equipment from the factory and cannot be used to replace one which has been utilized on other system boards.
3. If you do not follow the methods above, the Intel® Management Engine will not be updated and will cease to be effective.



### Note:

- a. You can take advantage of flash tools to update the default configuration of the BIOS (SPI ROM) to the latest version anytime.
- b. When the BIOS IC needs to be replaced, you have to populate it properly onto the system board after the EEPROM programmer has been burned and follow the technical person's instructions to confirm that the MAC address should be burned or not.

## Chapter 4 - Supported Software

Install drivers, utilities and software applications that are required to facilitate and enhance the performance of the system board. You may acquire the software from your sales representatives, from an optional DVD included in the shipment, or from the website download page at <https://www.dfi.com/DownloadCenter>.

### For Windows 10

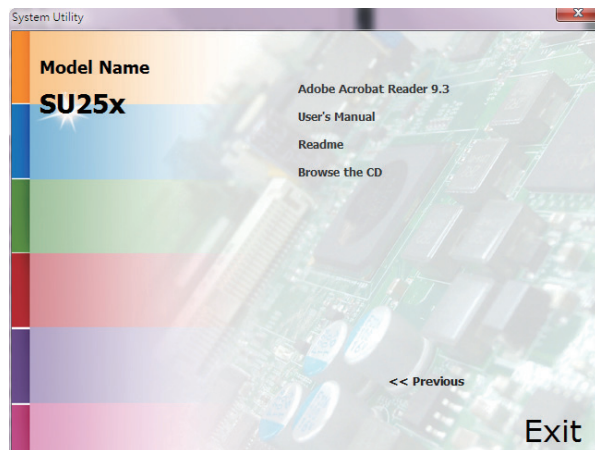
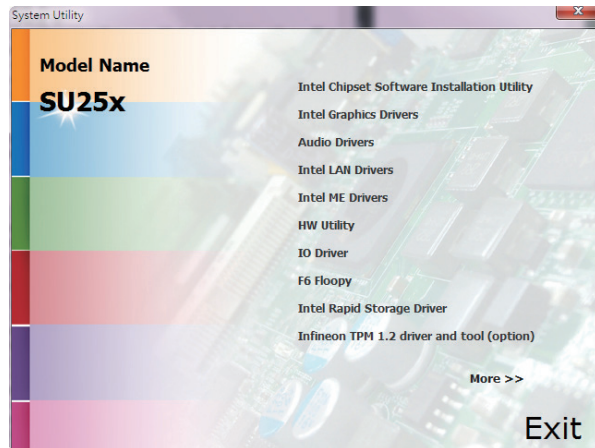

### For Windows 8.1

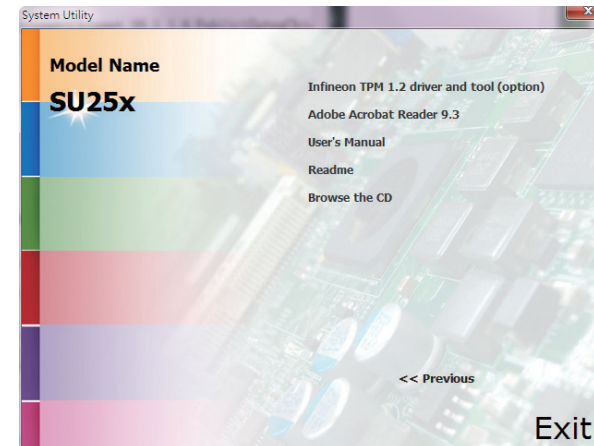
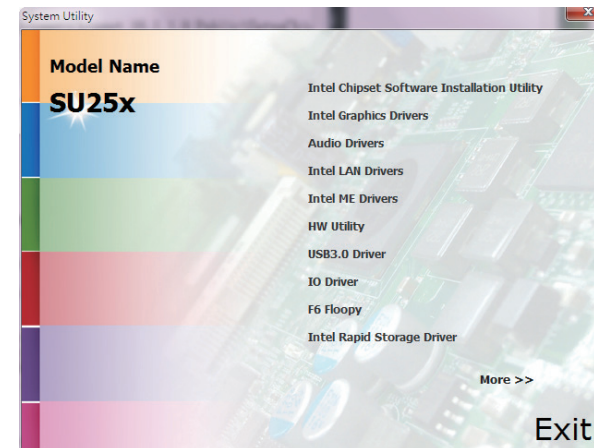

**Note:**

This step can be ignored if the applications are standalone files.

## For Windows 7

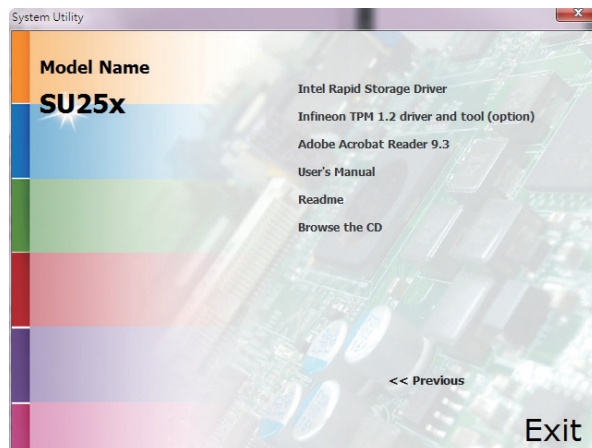
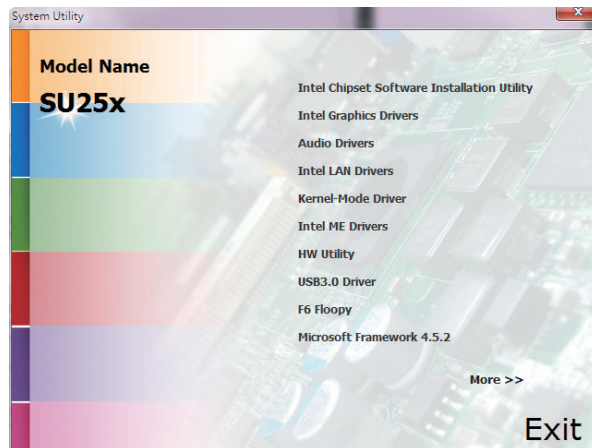

## Intel Chipset Software Installation Utility

The Intel Chipset Software Installation Utility is used for updating Windows® INF files so that the Intel chipset can be recognized and configured properly in the system.

To install the utility, click "Intel Chipset Software Installation Utility" on the main menu.

1. Setup is ready to install the utility. Click Next.



2. Read the license agreement then click Yes.

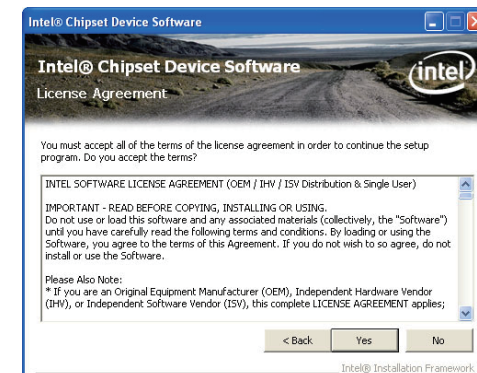

- Go through the readme document for more installation tips then click Next.



- Click Finish to exit setup.



## Intel Graphics Drivers

To install the driver, click "Intel Graphics Drivers" on the main menu.

- Setup is now ready to install the graphics driver. Click Next.



By default, the "Automatically run WinSAT and enable the Windows Aero desktop theme" is enabled. With this enabled, after installing the graphics driver and the system rebooted, the screen will turn blank for 1 to 2 minutes (while WinSAT is running) before the Windows 7/Windows 8.1/Windows 10 desktop appears. The "blank screen" period is the time Windows is testing the graphics performance.

- Read the license agreement then click Yes.

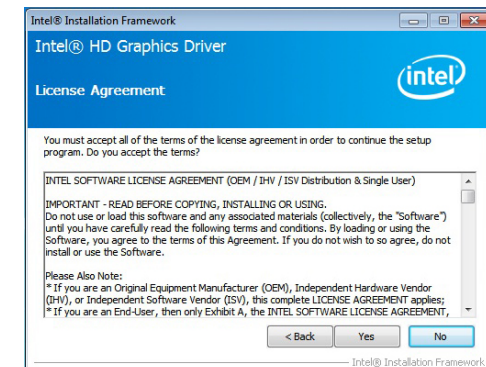

- Go through the readme document for system requirements and installation tips then click Next.

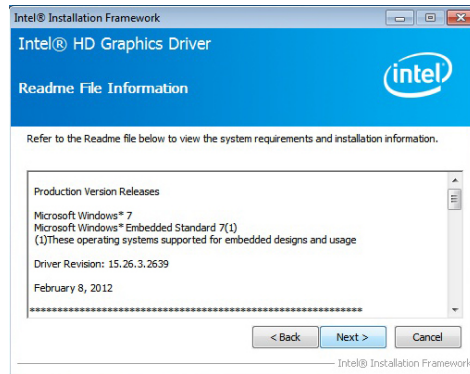

- Setup is now installing the driver. Click Next to continue.

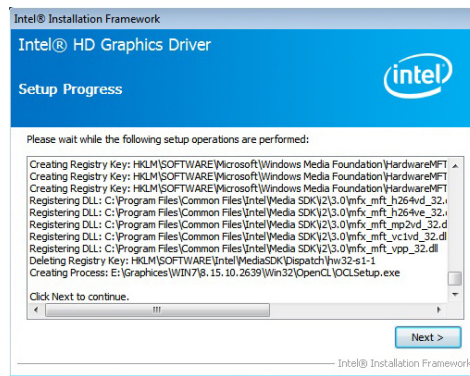

- Click "Yes, I want to restart this computer now" then click Finish.

Restarting the system will allow the new software installation to take effect.



## Audio Drivers

To install the driver, click "Audio Drivers" on the main menu.

- Setup is ready to install the driver. Click Next.

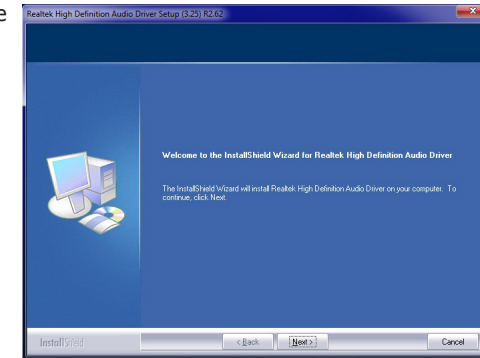

- Click "Yes, I want to restart my computer now" then click Finish.

Restarting the system will allow the new software installation to take effect.

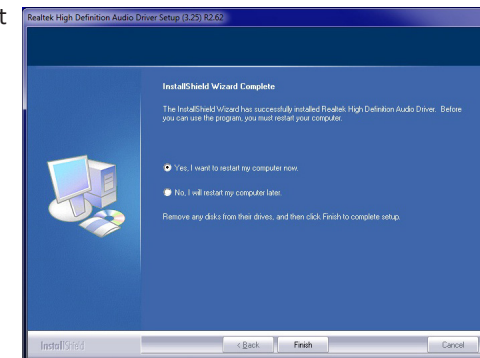



## Intel LAN Drivers

To install the driver, click "Intel LAN Drivers" on the main menu.

1. Setup is ready to install the driver. Click Next.



2. Click "I accept the terms in the license agreement" then click "Next".

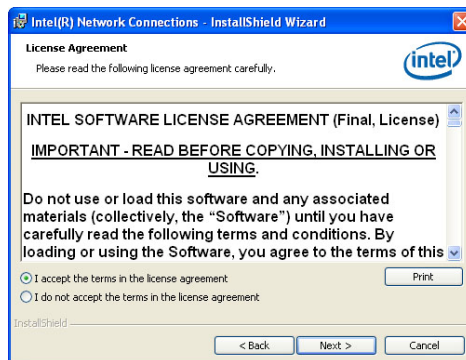

3. Select the program features you want installed then click Next.

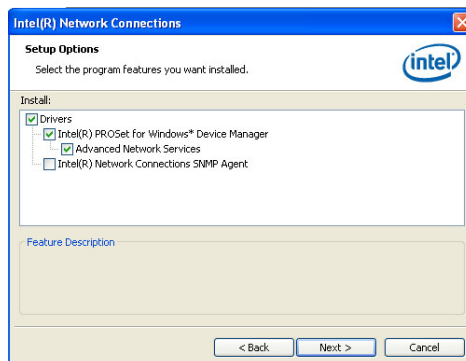

4. Click Install to begin the installation.

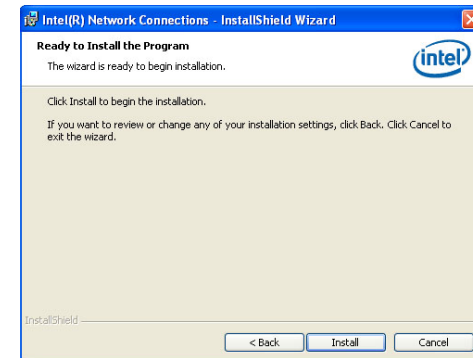

5. After completing installation, click Finish.

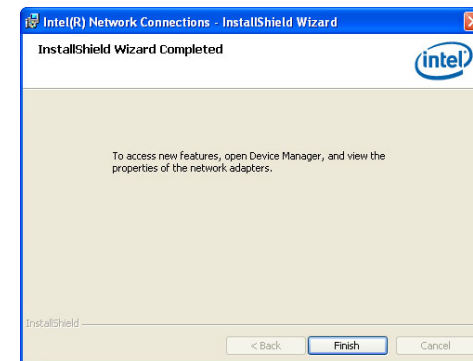

## Kernel Mode Driver Framework (For Windows 7 only)

To install the driver, click "Kernel Mode Driver Framework" on the main menu.

1. Click "Yes" to install the update.

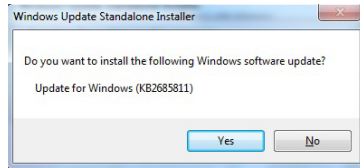

2. The update is installed now.

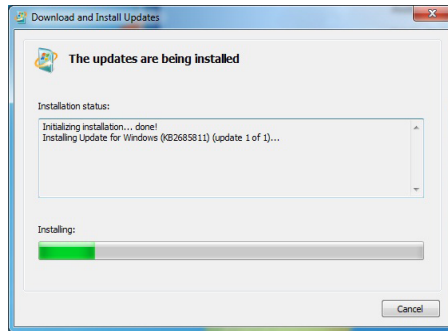

3. Click "Restart Now" to restart your computer when the installation is complete.

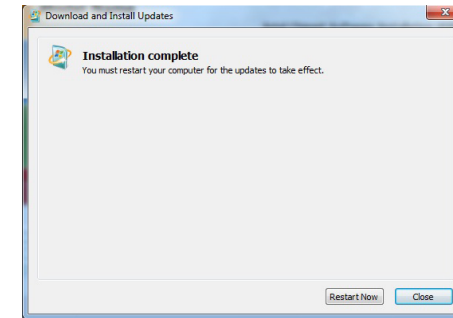

## Intel Management Engine Drivers

To install the driver, click "Intel Management Engine Drivers" on the main menu.

1. Setup is ready to install the driver. Click "Next".

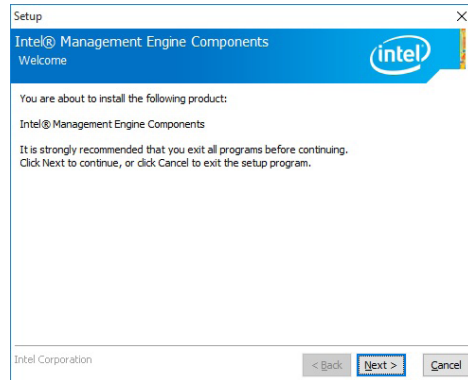

2. Read the license agreement then click "Next".

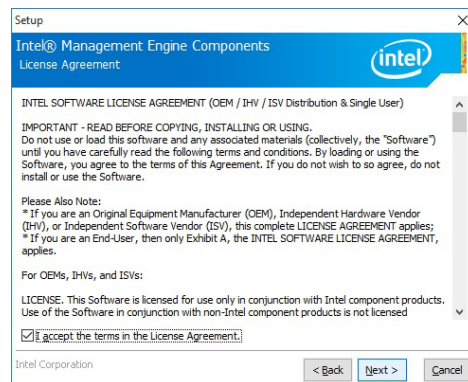

3. Setup is currently installing the driver. After installation has completed, click "Next".

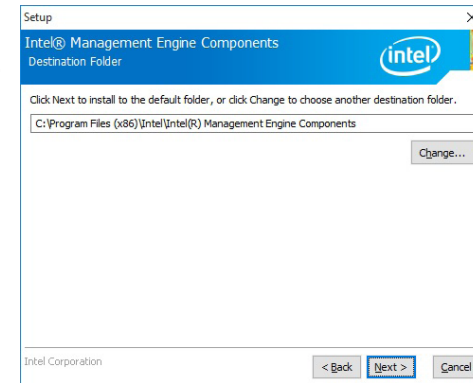

4. Please wait while the product is being installed.

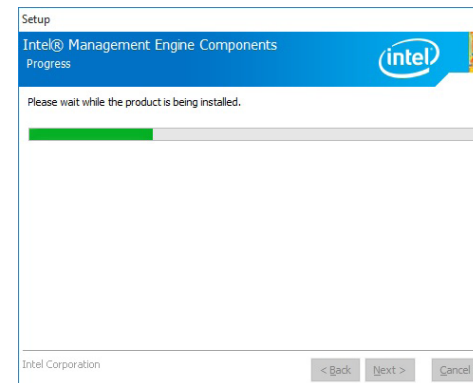

5. After completing installation, click "Finish".

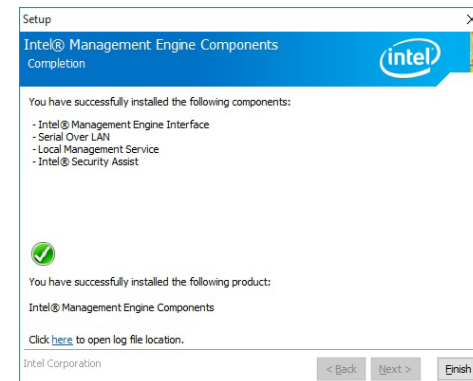

## HW Utility

HW Utility provides information about the board, Watchdog, and DIO. To access the utility, click "HW Utility" on the main menu.

**Note:** If you are using Windows 7 or later versions, you need to access the operating system as an administrator to be able to install the utility.

1. Setup is ready to install the driver.

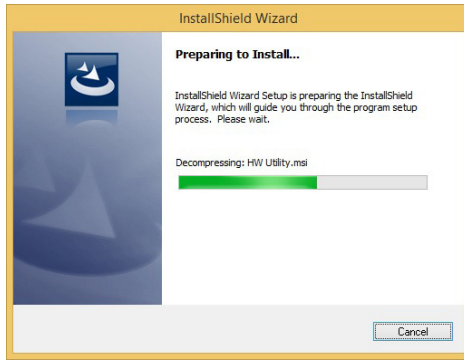

2. Click "Next" to continue.

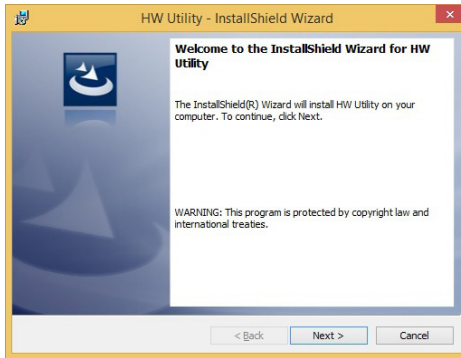

3. Read the license agreement then click "I accept the terms in the license agreement". Click "Next".

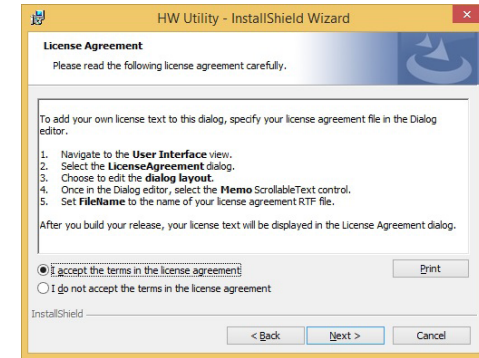

4. The wizard is ready to begin installation. Click "Install".

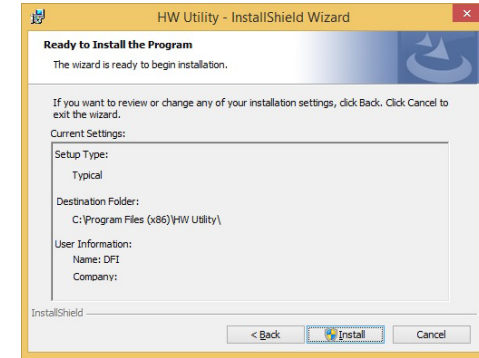

5. Please wait while the program features are being installed.

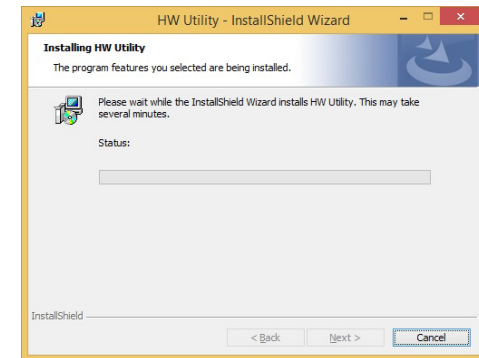

- After completing installation, click "Finish".

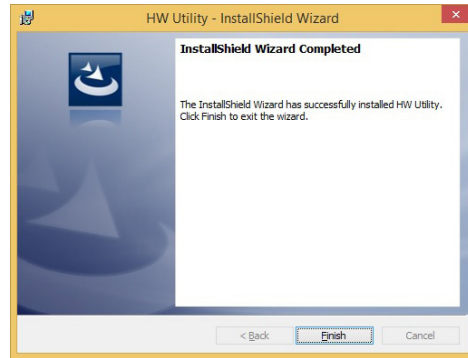

The HW Utility icon will appear on the desktop. Double-click the icon to open the utility.



Information

**Note:** Note: The screenshot displayed above is for illustrative purpose only, and may not resemble the actual screen.

The SU251 HW Utility features the following tabs: Information, HW Health, HW Health set, Watchdog, DIO and Backlight. Click on the tabs to access information about the board.

## Intel USB 3.0 Drivers (For Windows 7 and Windows 8.1)

To install the driver, click "Intel USB 3.0 Driver" on the main menu.

- Setup is ready to install the driver. Click Next.

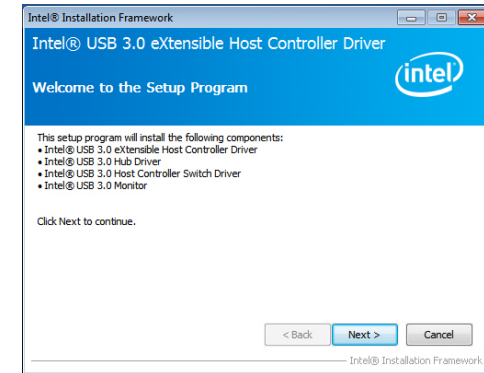

- Read the license agreement then click Yes.

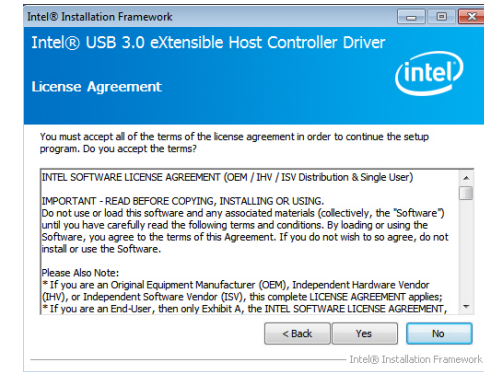

3. Go through the readme document for more installation tips then click Next.

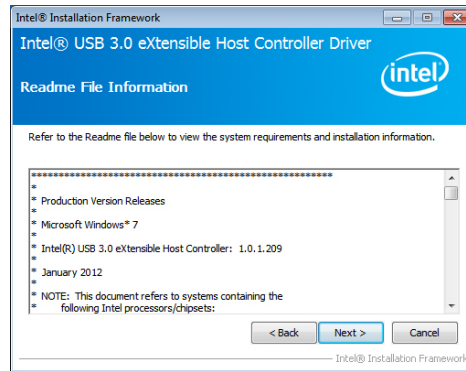

4. Setup is currently installing the driver. After installation has completed, click Next.

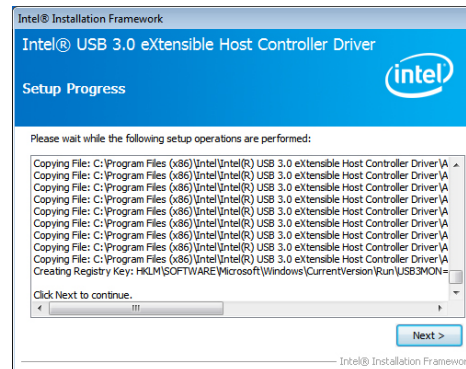

5. After completing installation, click Finish.



## IO Driver (For Windows 10 and Windows 8.1)

To install the driver, click "Intel Serial IO Driver" on the main menu

1. Setup is ready to install the driver. Click Next.

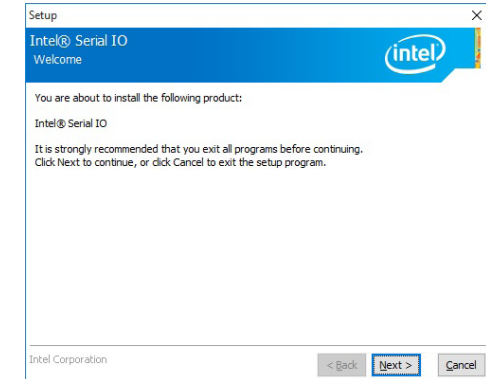

2. Read the license agreement carefully. Click "I accept the terms in the License Agreement" then click Next.

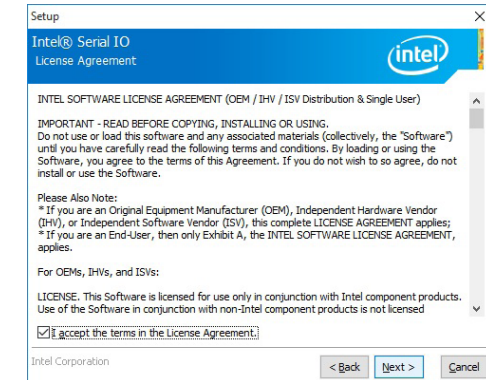

3. Read the file information then click Next.

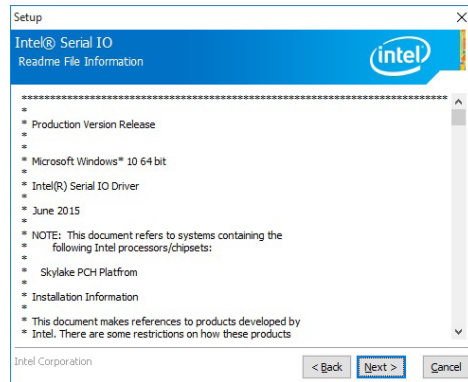

4. Setup is ready to install the driver. Click Next.

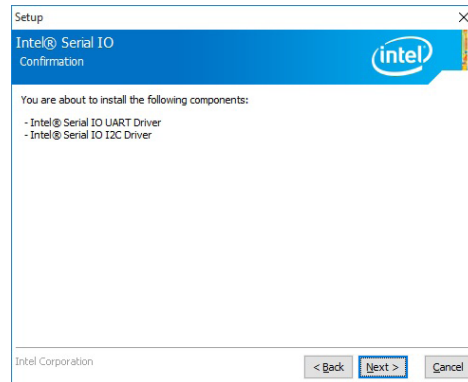

5. Setup is now installing the driver.

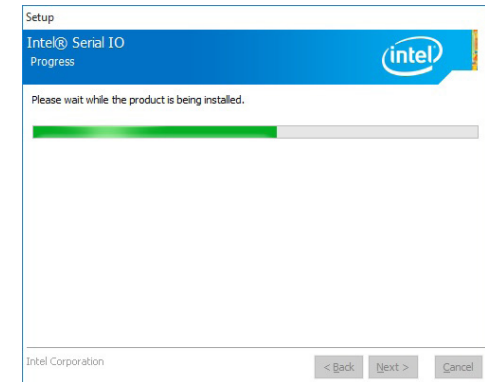

6. Click Finish.

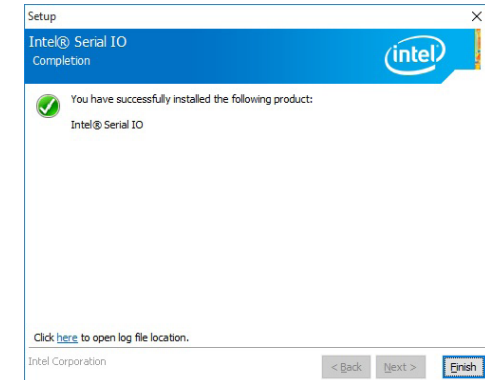

## Microsoft Framework 4.5.2 (For Windows 7)

**Note:**

Before installing Microsoft Framework 4.5.2, make sure you have updated your Windows 7 operating system to Service Pack 1.

To install the driver, click "Microsoft Framework 4.5.2" on the main menu.

1. Setup is now extracting files.

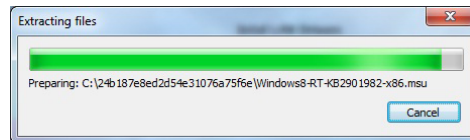

2. Read the license agreement carefully.

Click "I have read and accept the terms of the License Agreement" then click "Install".

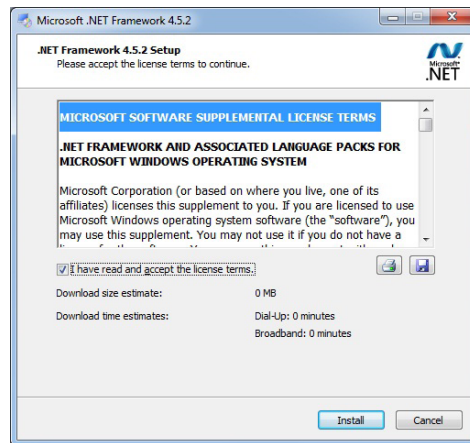

3. Setup is now installing the driver.

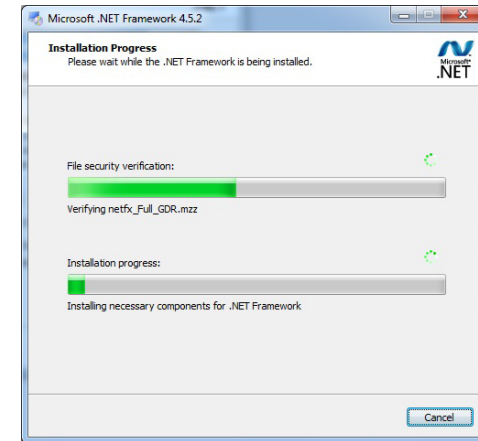

4. Click "Finish".

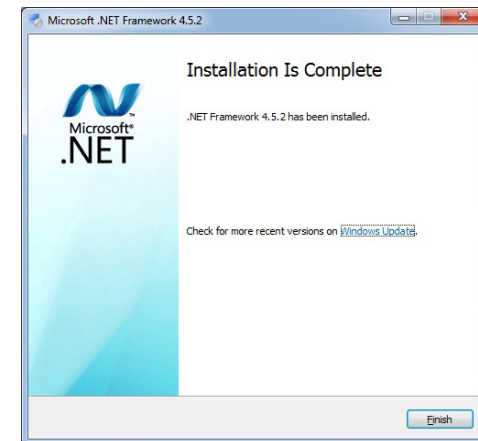



## Intel Rapid Storage Technology

The Intel Rapid Storage Technology is a utility that allows you to monitor the current status of the SATA drives. It enables enhanced performance and power management for the storage subsystem.

To install the driver, click "Intel Rapid Storage Technology" on the main menu. Please refer to **Chapter 5** for more information.

## Infinion TPM 1.2 Driver and Tool (Optional)

To install the driver, click "Infinion TPM driver and tool (option)" on the main menu.

1. The setup program is preparing to install the driver.

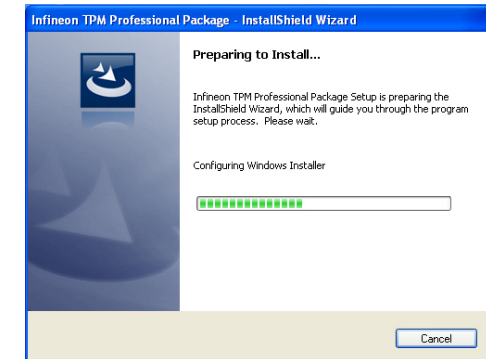

2. The setup program is now ready to install the utility. Click "Next".

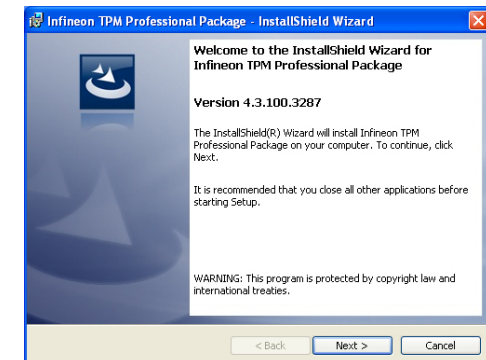

3. Click "I accept the terms in the license agreement" and then click "Next".

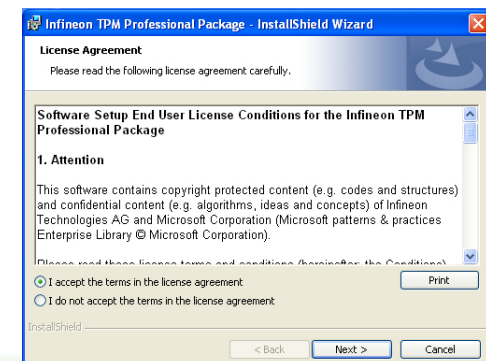

4. Enter the necessary information and then click "Next".

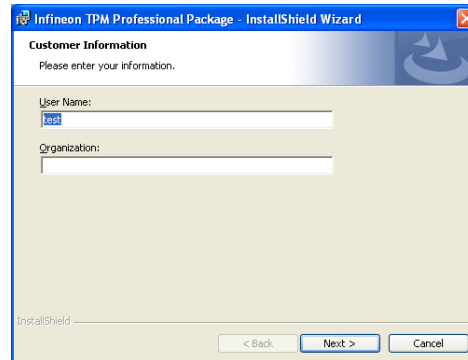

5. Select a setup type and then click "Next".

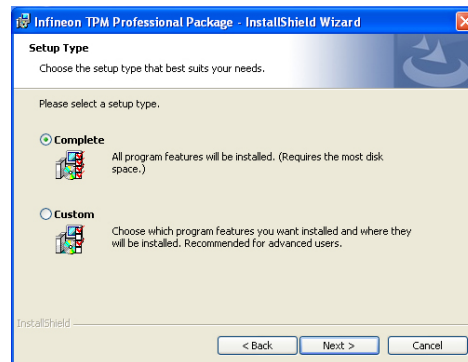

6. Click "Install".

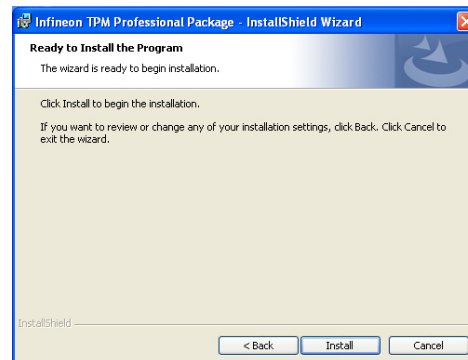

7. TPM requires installing the Microsoft Visual C++ package prior to installing the utility. Click "Install".

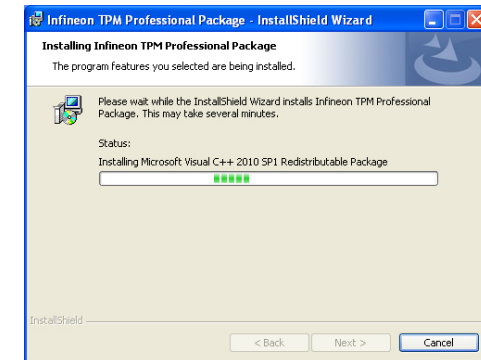

8. The setup program is currently installing the Microsoft Visual C++ package.

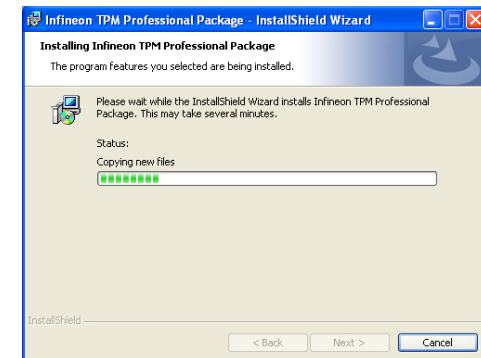

9. Click "Finish".

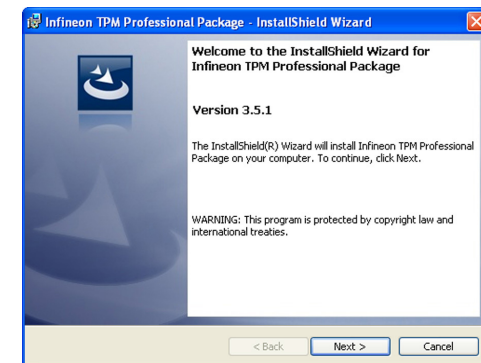

10. Click "Yes" to restart your system.

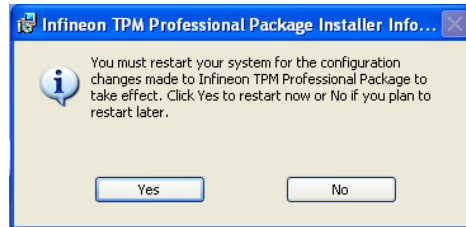

## Adobe Acrobat Reader 9.3

To install the reader, click "Adobe Acrobat Reader 9.3" on the main menu.

1. Click Next to install or click Change Destination Folder to select another folder.

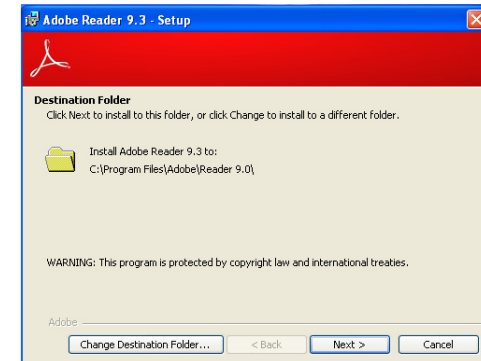

2. Click Install to begin installation.

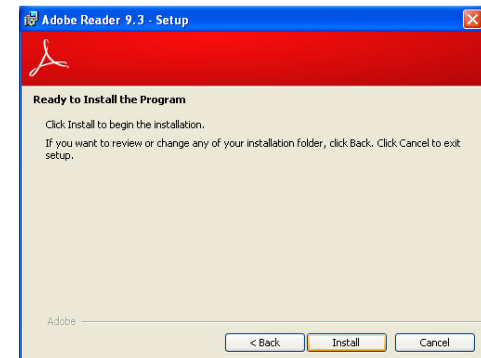

3. Click Finish to exit installation.

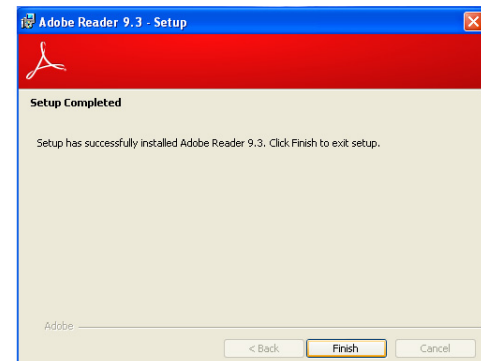

## Chapter 5 - RAID

---

The system board allows configuring RAID on Serial ATA drives. It supports RAID 0, RAID 1, and RAID 5.

### RAID Levels

#### RAID 0 (Striped Disk Array without Fault Tolerance)

RAID 0 uses two new identical hard disk drives to read and write data in parallel, interleaved stacks. Data is divided into stripes and each stripe is written alternately between two disk drives. This improves the I/O performance of the drives at different channel; however it is not fault tolerant. A failed disk will result in data loss in the disk array.

#### RAID 1 (Mirroring Disk Array with Fault Tolerance)

RAID 1 copies and maintains an identical image of the data from one drive to the other drive. If a drive fails to function, the disk array management software directs all applications to the other drive since it contains a complete copy of the drive's data. This enhances data protection and increases fault tolerance to the entire system. Use two new drives or an existing drive and a new drive but the size of the new drive must be the same or larger than the existing drive.

#### RAID 5

RAID 5 stripes data and parity information across hard drives. It is fault tolerant and provides better hard drive performance and more storage capacity.

### Settings

To enable the RAID function, the following settings are required.

1. Connect the Serial ATA drives.
2. Enable Serial ATA in the Insyde BIOS.
3. Create a RAID volume.
4. Install the Intel Rapid Storage Technology Utility.

#### Step 1: Connect the Serial ATA Drives

Refer to chapter 2 for details on connecting the Serial ATA drives.

**Important:**

1. Make sure you have installed the Serial ATA drives and connected the data cables otherwise you won't be able to enter the RAID BIOS utility.
2. Treat the cables with extreme caution especially while creating RAID. A damaged cable will ruin the entire installation process and operating system. The system will not boot and you will lost all data in the hard drives. Please give special attention to this warning because there is no way of recovering back the data.

#### Step 2: Enable RAID in the BIOS

1. Power-on the system then press <Del> to enter the main menu of the Insyde BIOS.
2. Go to "Advanced" menu, and select the "SATA Configuration" menu.
3. Change the "SATA Mode Selection" to "RAID" mode.
4. Save the changes in the "Save & Exit" menu.
5. Reboot the system.

### Step 3: Create a RAID Volume

1. When the Intel® RST option ROM status screen displays during POST, press <Ctrl> and <I> simultaneously to enter the option ROM user interface.
2. Select 1: Create RAID Volume and press <Enter>.
3. Use the up or down arrow keys to select the RAID level and press <Enter>.
4. Use the up or down arrow keys to select the strip size and press <Enter>.
5. Press <Enter> to select the physical disks.
6. Use the up or down arrow keys to scroll through the list of hard drives and press <Space> to select the drive.
7. Press <Enter>.
8. Select the volume size and press <Enter>. You must select less than one hundred percent of the available volume space to leave space for the second volume.
9. Press <Enter> to create the volume.
10. At the prompt, press <Y> to confirm volume creation.
11. Select 4: Exit and press <Enter>.
12. Press <Y> to confirm exit.



**Note:**

These steps are cited from the Intel® Support site, "Set Up a System with Intel® Matrix RAID Technology" (Article ID: 000005789).  
<http://www.intel.com/content/www/us/en/support/boards-and-kits/000005789.htm>

### Step 3-1: Create a RAID Volume if the boot type is UEFI

If the boot type is set to UEFI, RAID volume creation will be different. Please use the following steps to create RAID volumes. To set the boot type, enter the Insyde BIOS and go to "Boot" >"Boot type".

1. Go to the "Advanced" menu of the Insyde BIOS.
2. The "Intel® Rapid Storage Technology" menu appears. Enter this menu.

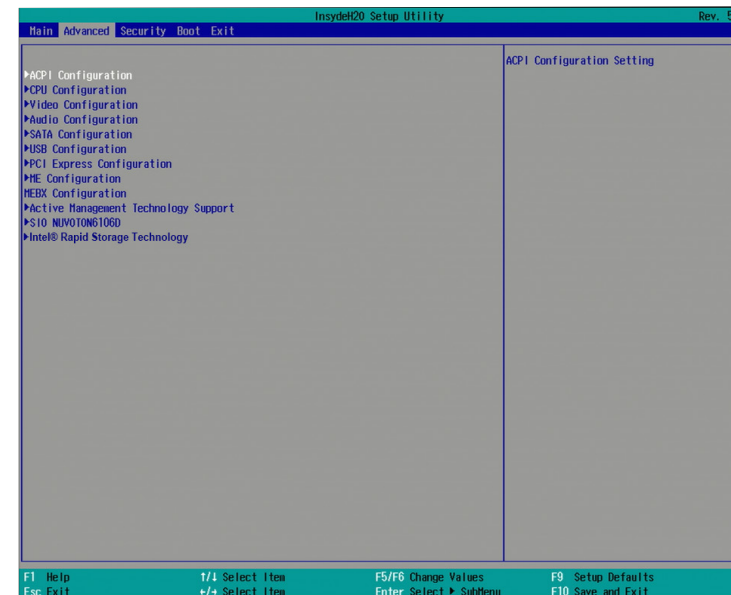

3. The screen displays all available drives. Select "Create RAID volume" to create a RAID volume".
4. Use the up or down arrow keys to select the RAID level and press <Enter>.
5. Use the up or down arrow keys to scroll through the list of hard drives and press <Space> to select the drive.
6. Press <Enter>.
7. Use the up or down arrow keys to select the strip size and press <Enter>.
8. Enter the volume size and press <Enter>.
9. At the prompt, press <Y> to confirm volume creation.

## Step 4: Install the Intel Rapid Storage Technology Utility

The Intel Rapid Storage Technology Utility can be installed from within Windows. It allows RAID volume management (create, delete, migrate) from within the operating system. It will also display useful SATA device and RAID volume information. The user interface, tray icon service and monitor service allow you to monitor the current status of the RAID volume and/or SATA drives. It enables enhanced performance and power management for the storage subsystem.

1. Insert the provided DVD into an optical drive.
2. Click "Intel Rapid Storage Technology Utility" on the main menu.
3. Setup is ready to install the utility. Click Next.

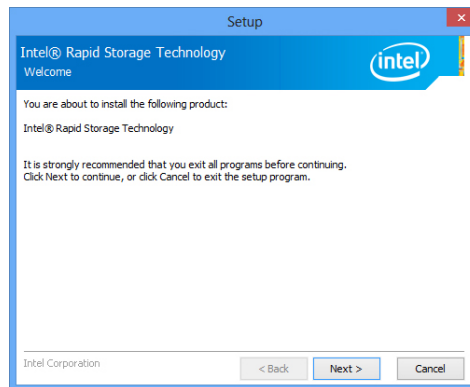

4. Read the license agreement and click "I accept the terms in the License Agreement." Then, click Next.

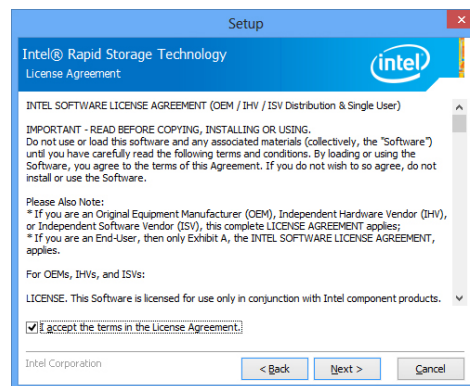

5. Go through the readme document to view system requirements and installation information then click Next.

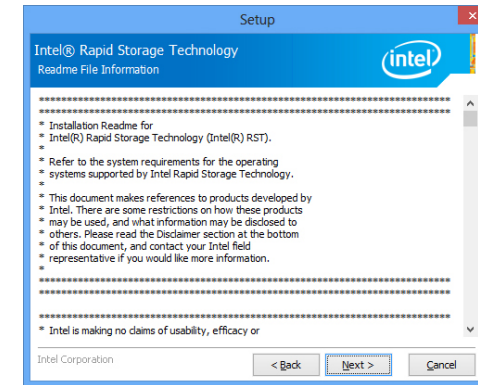

6. Click Next to install to the default folder or click change to choose another destination folder.

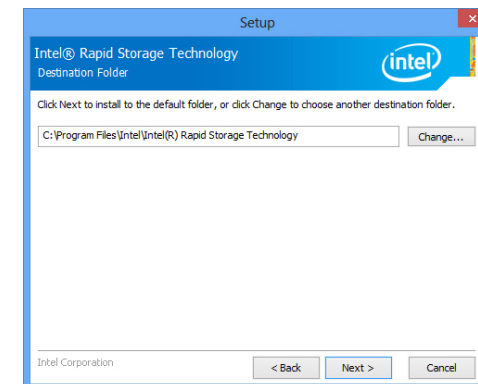

7. Confirm the installation and click Next.

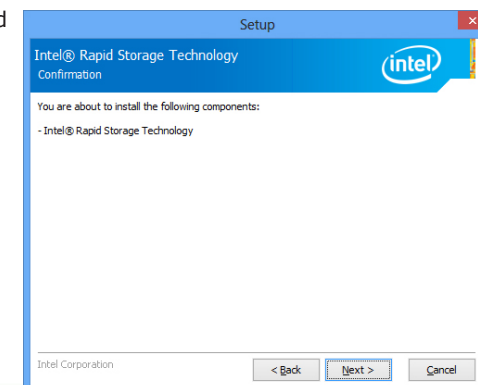

8. Click “Yes, I want to restart this computer now” to complete the installation and then click Finish.



## Chapter 6 - Intel AMT Settings

### Overview

Intel Active Management Technology (Intel® AMT) combines hardware and software solution to provide maximum system defense and protection to networked systems.

The hardware and software information are stored in non-volatile memory. With its built-in manageability and latest security applications, Intel® AMT provides the following functions.

- **Discover**

Allows remote access and management of networked systems even while PCs are powered off; significantly reducing desk-side visits.

- **Repair**

Remotely repair systems after OS failures. Alerting and event logging help detect problems quickly to reduce downtime.

- **Protect**

Intel AMT's System Defense capability remotely updates all systems with the latest security software. It protects the network from threats at the source by proactively blocking incoming threats, reactively containing infected clients before they impact the network, and proactively alerting when critical software agents are removed.

### Enable Intel® AMT in the Insyde BIOS

1. Power-on the system then press <Del> to enter the main menu of the Insyde BIOS.
2. In the **Advanced** menu, select **Active Management Technology Support**.

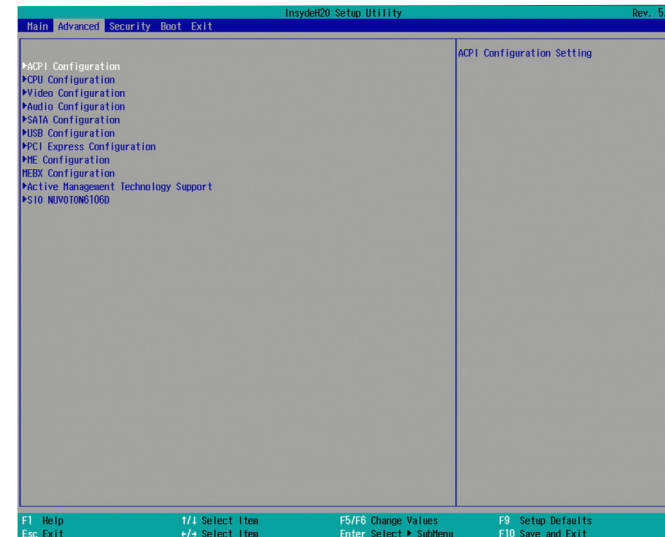

3. In the **Advanced** menu, select **Enabled** for the **AMT Support** option.

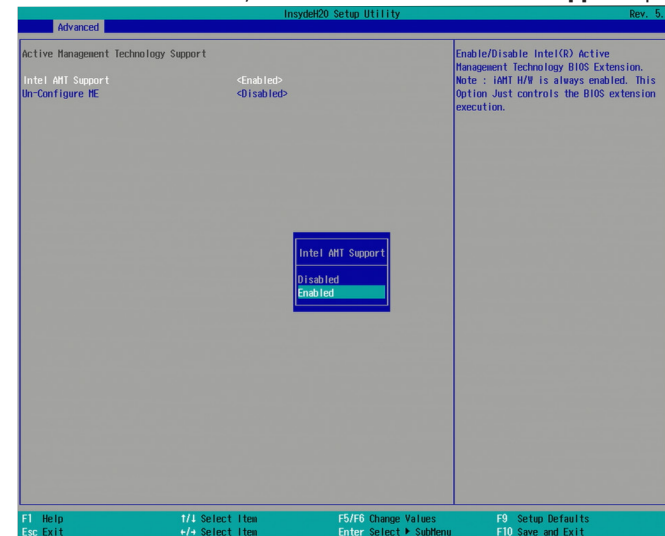

#### Un-Configure ME

Un-configure ME without password. You can select enabled or disabled.



4. In the **Exit** menu, select **Exit Saving Changes** then select **OK**.



## Enable Intel® AMT in the Intel® Management Engine BIOS Extension (MEBX) Screen

1. When the system reboots, you will be prompted for a password. The default password is **admin**. Enter the default password in the space provided under Intel(R) ME Password then press Enter.

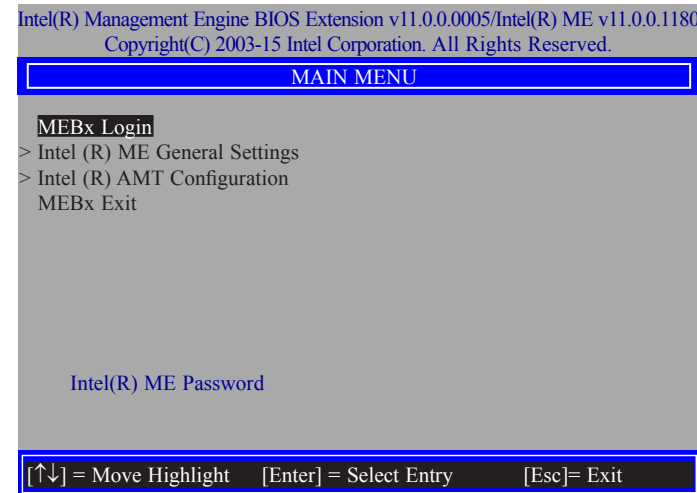

2. Enter a password in the space provided under Intel(R) ME Password then press Enter. The password must include:

- 8-32 characters
- Strong 7-bit ASCII characters excluding : , and " characters
- At least one digit character (0, 1, ...9)
- At least one 7-bit ASCII non alpha-numeric character, above 0x20, (e.g. !, \$, ;)
- Both lower case and upper case characters

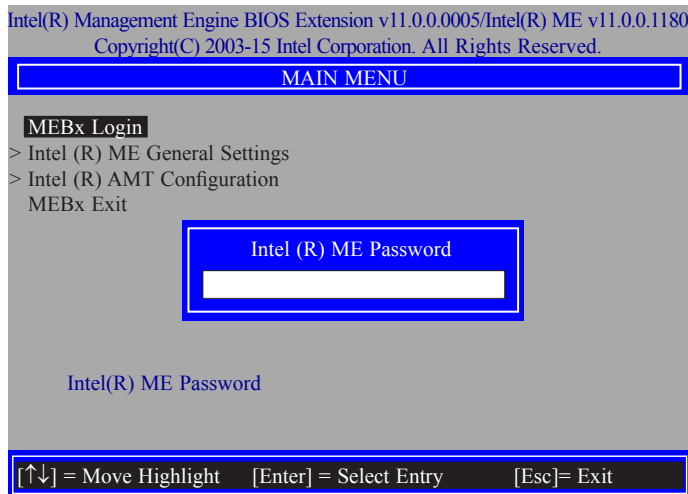

3. You will be asked to verify the password. Enter the same new password in the space provided under Verify Password then press Enter.

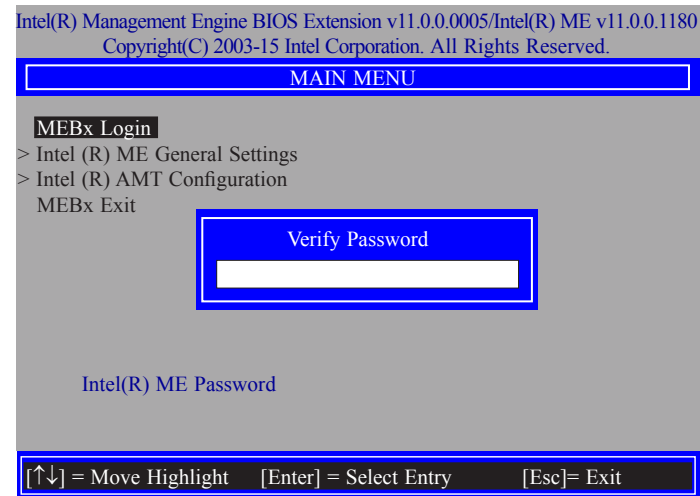

4. Select **Intel(R) ME General Settings** then press Enter.

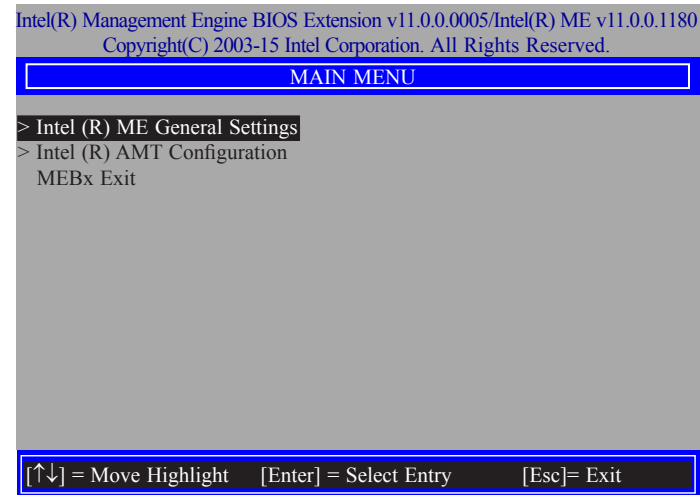

5. Select **Change Intel(R) ME Password** then press Enter.

You will be prompted for a password. The default password is "admin". Enter the default password in the space provided under Intel(R) ME New Password then press Enter.

- 8-32 characters
- Strong 7-bit ASCII characters excluding : , and " characters
- At least one digit character (0, 1, ...9)
- At least one 7-bit ASCII non alpha-numeric character, above 0x20, (e.g. !, \$, ;)
- Both lower case and upper case characters

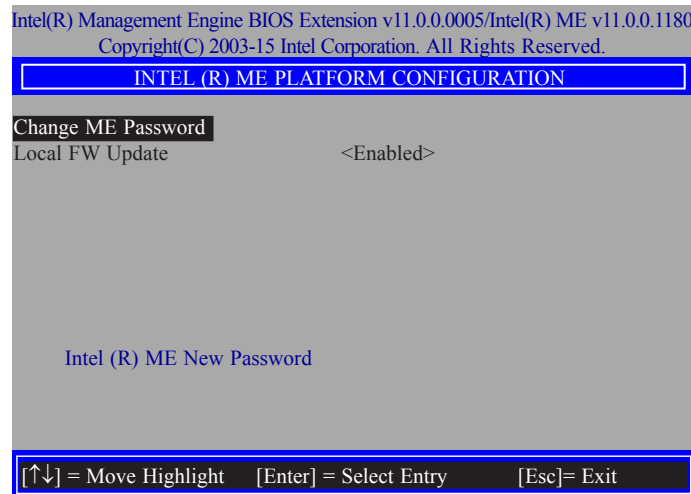

6. Select **Local FW Update** then press Enter. Select **Enabled** or **Disabled** or **password Protected** then press Enter.

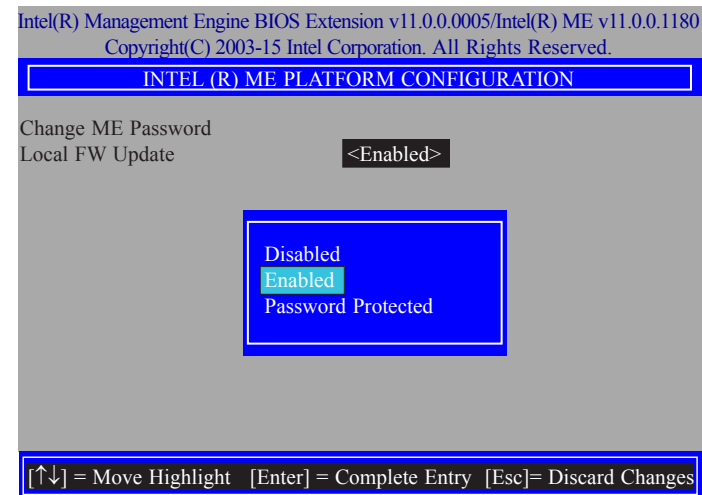

7. Select Previous Menu until you return to the **Main Menu**. Select **Intel(R) AMT Configuration** then press Enter.

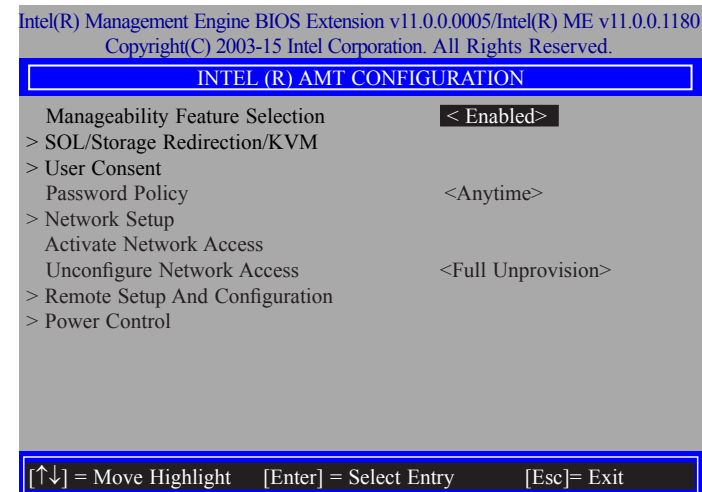

8. In the **Intel(R) AMT Configuration** menu, select **Manageability Feature Selection** then press Enter. Select **Enabled** or **Disabled** then press Enter.

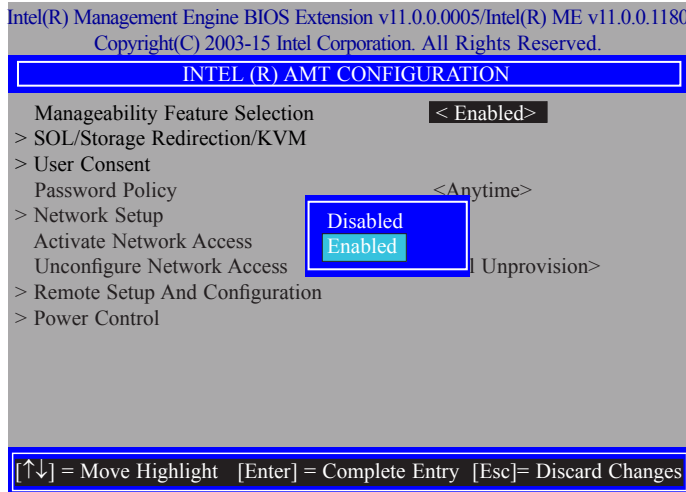

10. In the **SOL/Storage Redirection/KVM** menu, select **Username and Password** then press Enter. Select **Enabled** or **Disabled** then press Enter.

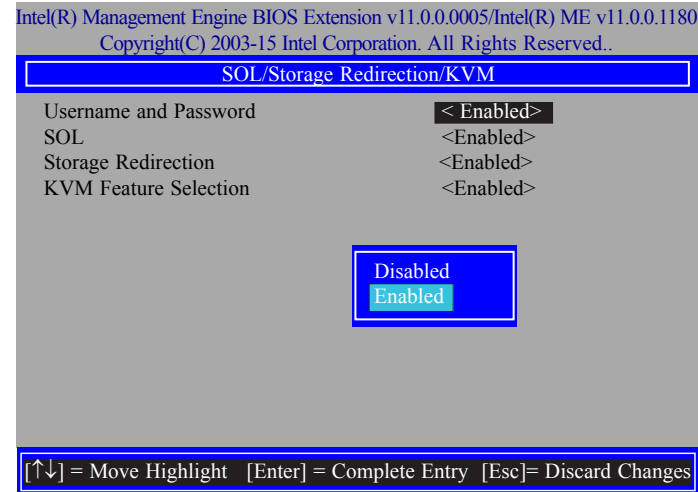

9. In the **Intel(R) AMT Configuration** menu, select **SOL/Storage Redirection/KVM** then press Enter.

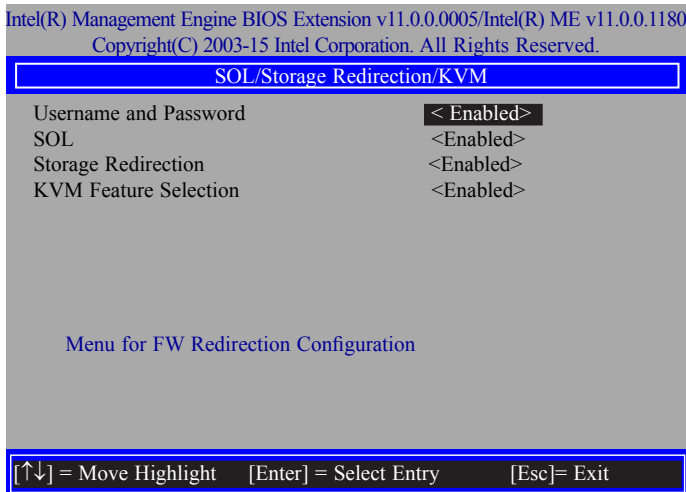

11. In the **SOL/Storage Redirection/KVM** menu, select **SOL** then press Enter. Select **Enabled** or **Disabled** then press Enter.

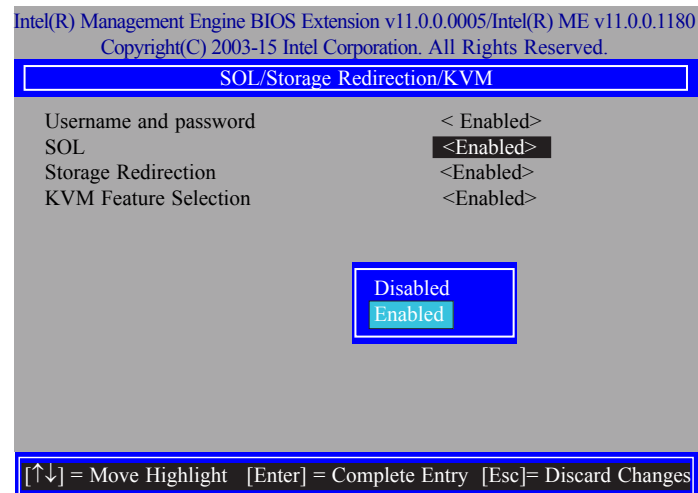

12. In the **SOL/Storage Redirection/KVM** menu, select **Storage Redirection** then press Enter. Select **Enabled** or **Disabled** then press Enter.

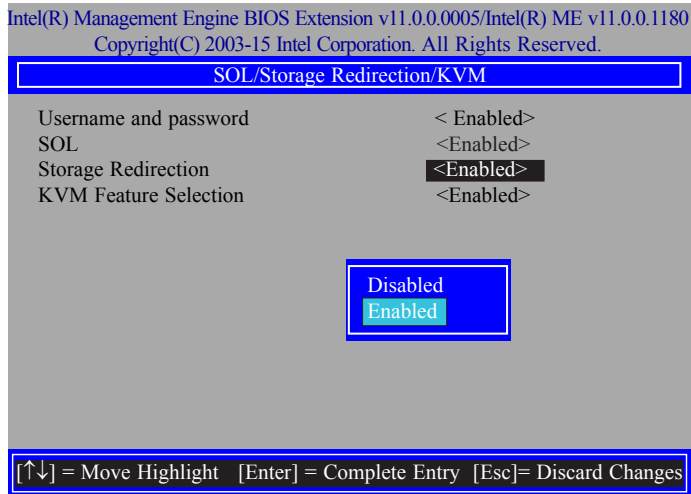

14. Select Previous Menu until you return to the **Intel(R) AMT Configuration** menu. Select **User Consent** then press Enter.

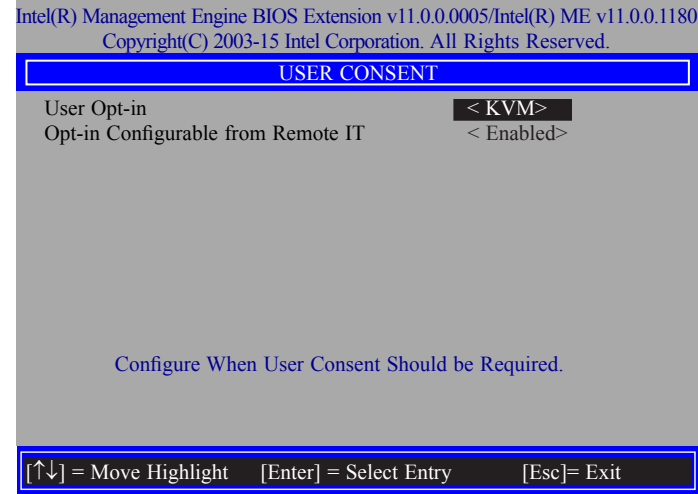

13. In the **SOL/IDER/KVM** menu, select **KVM Feature Selection** then press Enter. Select **Enabled** or **Disabled** then press Enter.

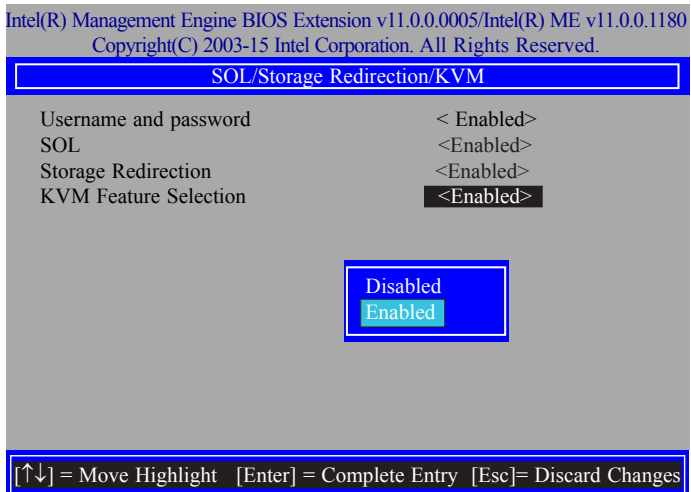

15. In the **User Consent** menu, select **User Opt-in** then press Enter. Select **None** or **KVM** or **ALL** then press Enter.

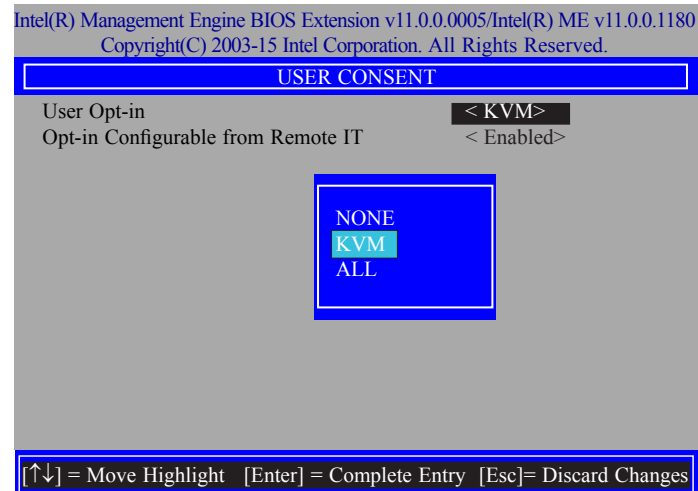

16. In the **User Consent** menu, select **Opt-in Configurable from Remote IT** then press Enter. Select **Enabled** or **Disable Remote Control of KVM Opt-in Policy** then press Enter.

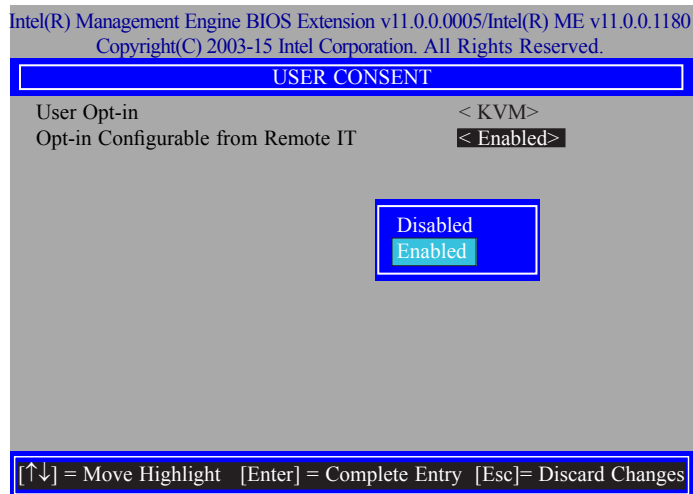

17. Select Previous Menu until you return to the **Intel(R) AMT Configuration** menu. Select **Password Policy** then press Enter.

You may choose to use a password only during setup and configuration or to use a password anytime the system is being accessed.

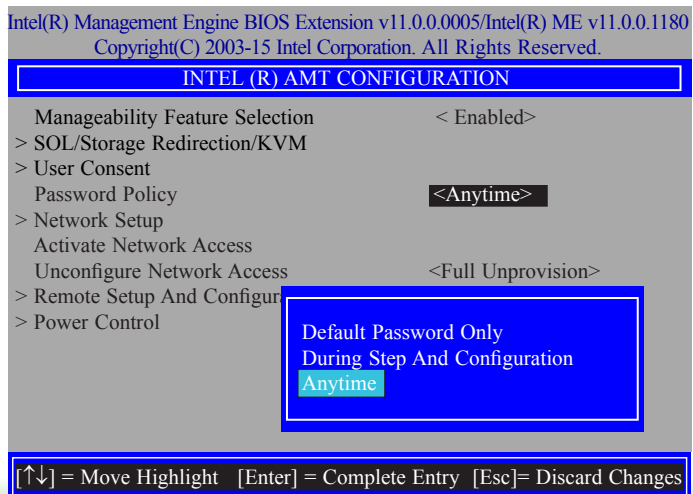

18. In the **Intel(R) AMT Configuration** menu, select **Network Setup** then press Enter.

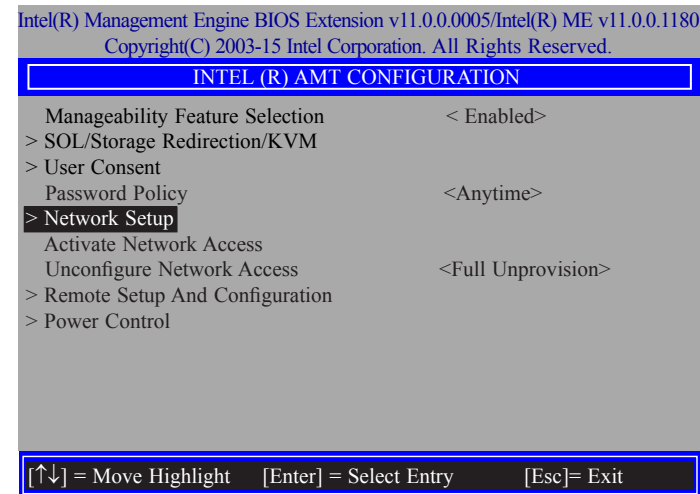

19. In the **Intel(R) ME Network Setup** menu, select **Intel(R) ME Network Name Settings** then press Enter.

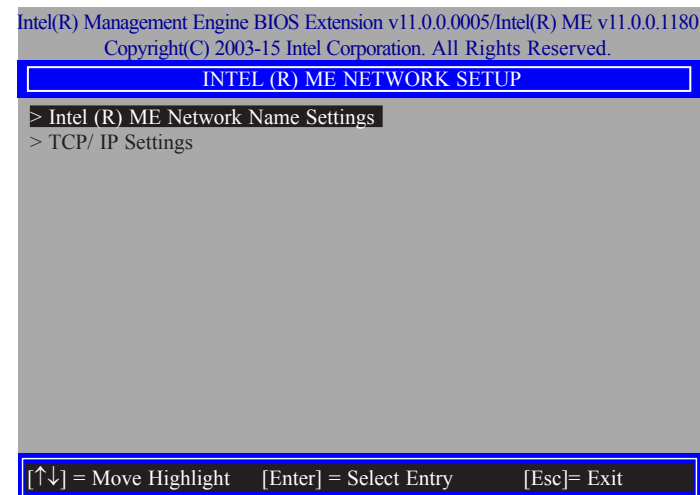

20. In the **Intel(R) ME Network Name Settings** menu, select **Host Name** then press Enter. Enter the computer's host name then press Enter.

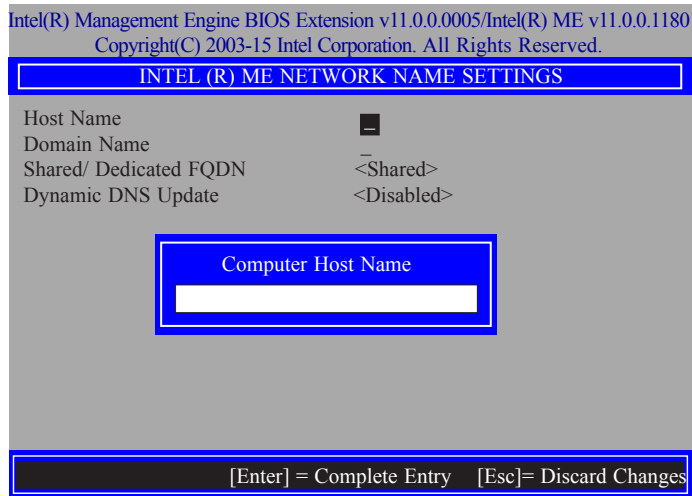

22. Select **Shared/Dedicated FQDN** then press Enter. Select **Shared** or **Dedicated** then press Enter.

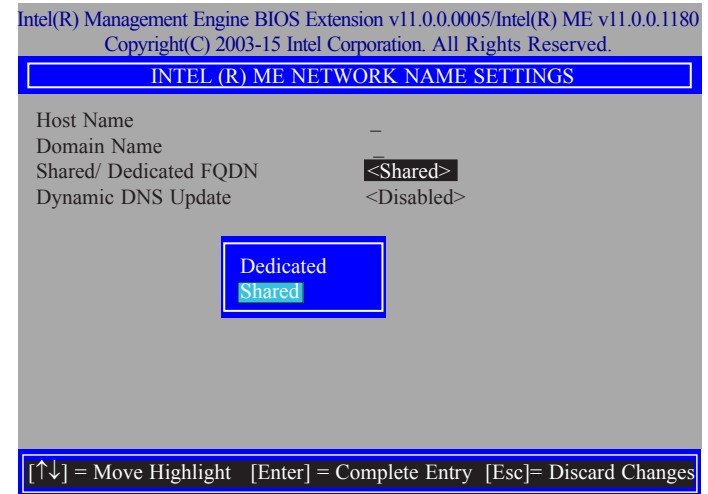

21. Select **Domain Name** then press Enter. Enter the computer's domain name then press Enter.

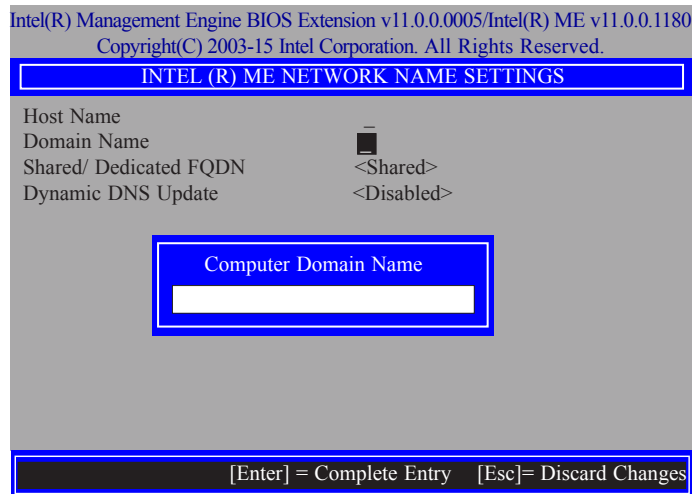

23. Select **Dynamic DNS Update** then press Enter. Select **Enabled** or **Disabled** then press Enter.

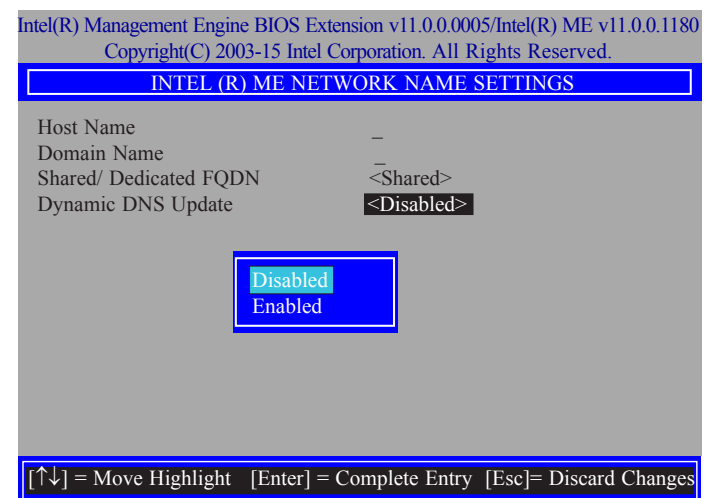

24. Select Previous Menu until you return to the **Intel(R) ME Network Setup** menu. Select **TCP/IP Settings** then press Enter.

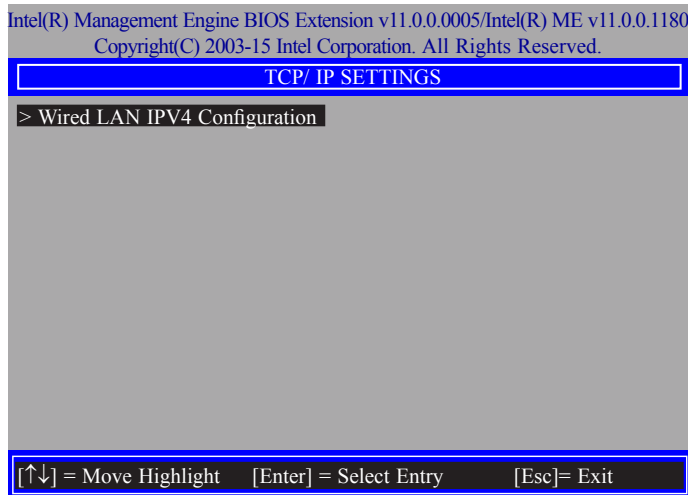

25. In the **TCP/IP Settings** menu, select **Wired LAN IPV4 Configuration** then press Enter.

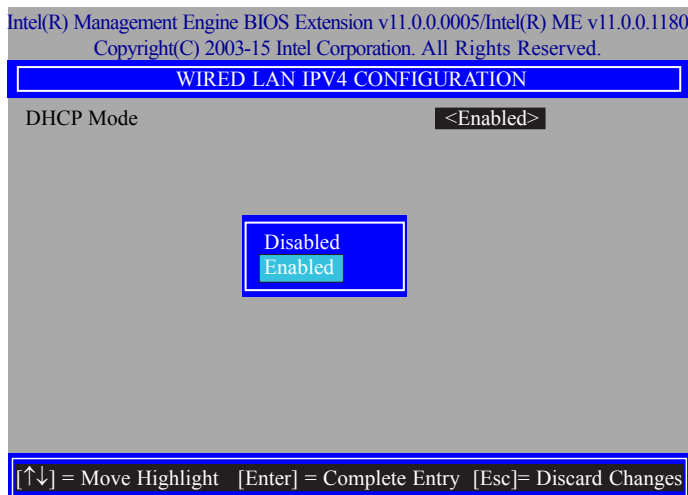

26. In the **Intel(R) AMT Configuration** menu, select **Activate Network Access** then press Enter.

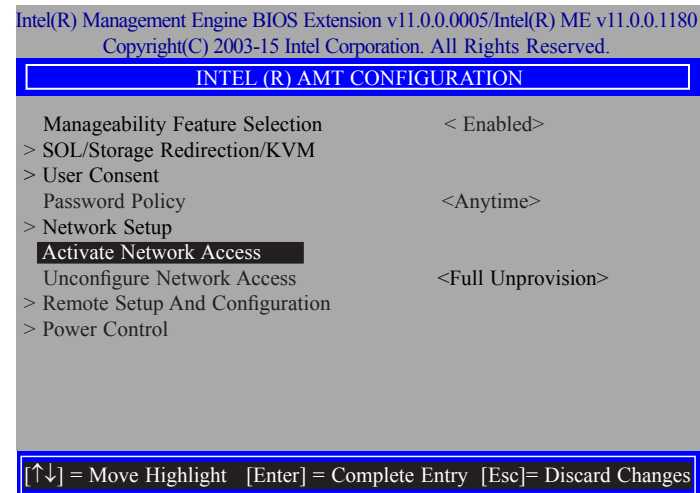

27. In the **Intel(R) AMT Configuration** menu, select **Unconfigure Network Access** then press Enter.

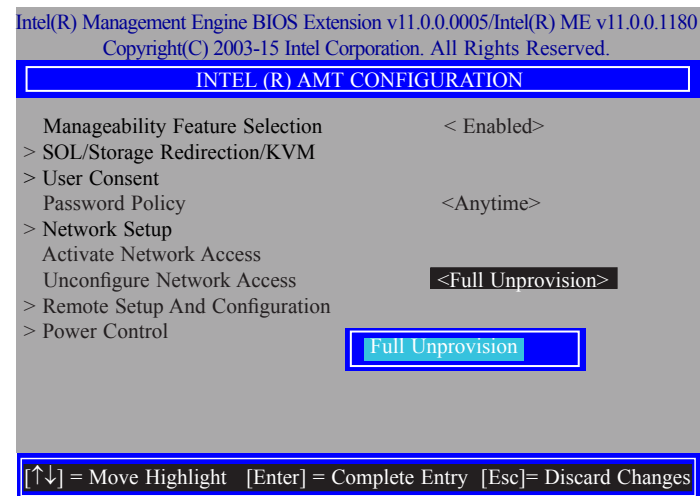



28. In the **Intel(R) AMT Configuration** menu, select **Remote Setup And Configuration** then press Enter.

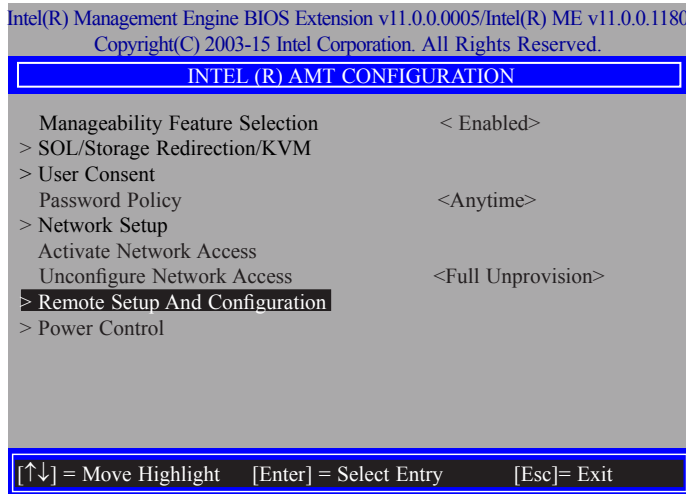

30. In the **Intel(R) Remote Setup And Configuration** menu, select **Provisioning Record** then press Enter.

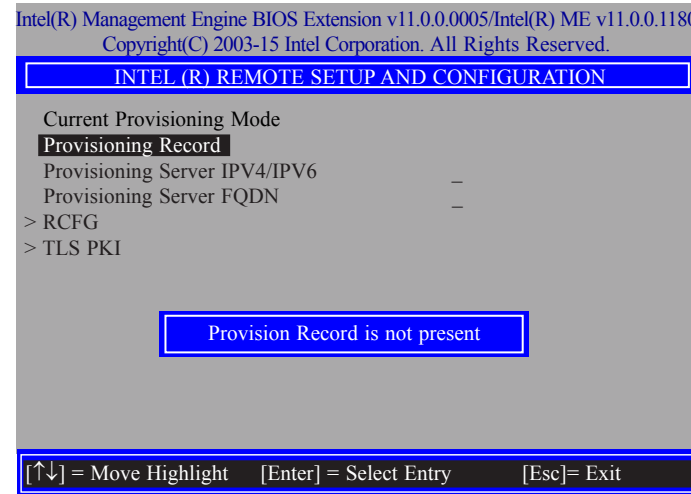

29. In the **Intel(R) Remote Setup And Configuration** menu, select **Current Provisioning Mode** then press Enter.

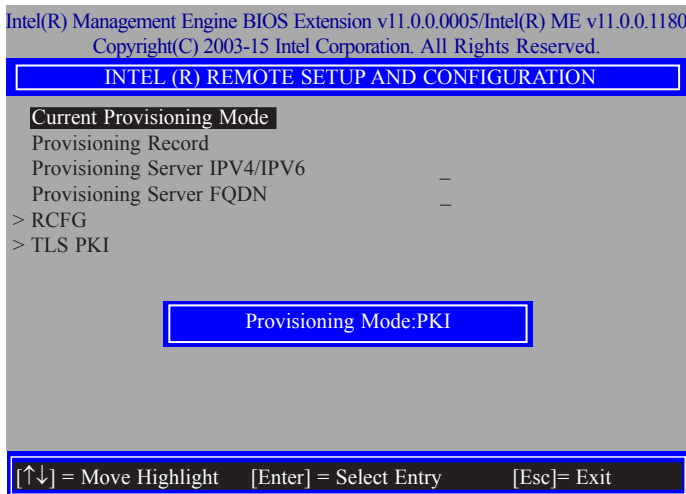

31. In the **Intel(R) Remote Setup And Configuration** menu, select **Provisioning server IPV4/IPV6**, enter the Provisioning server address then press Enter.

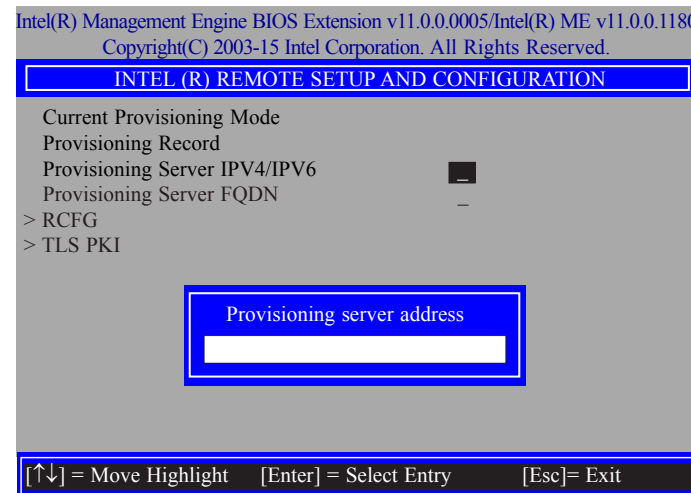

32. In the **Intel(R) Remote Setup And Configuration** menu, select **Provisioning server FQDN**, enter the FQDN of Provisioning server then press Enter.

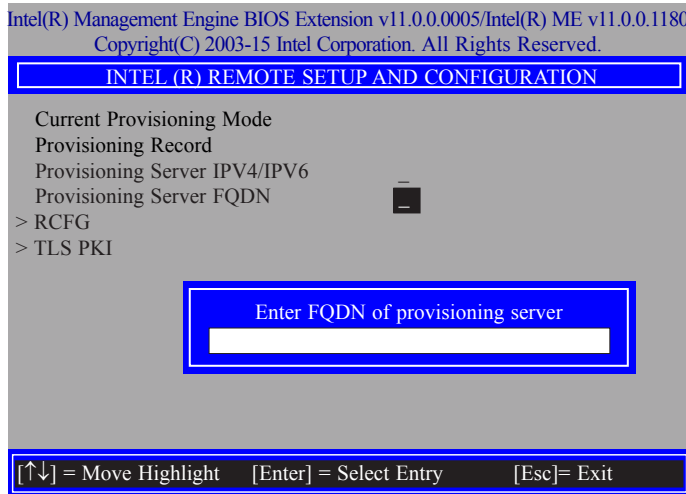

34. In the **Intel(R) Remote Setup And Configuration** menu, select **TLS PKI** then press Enter.

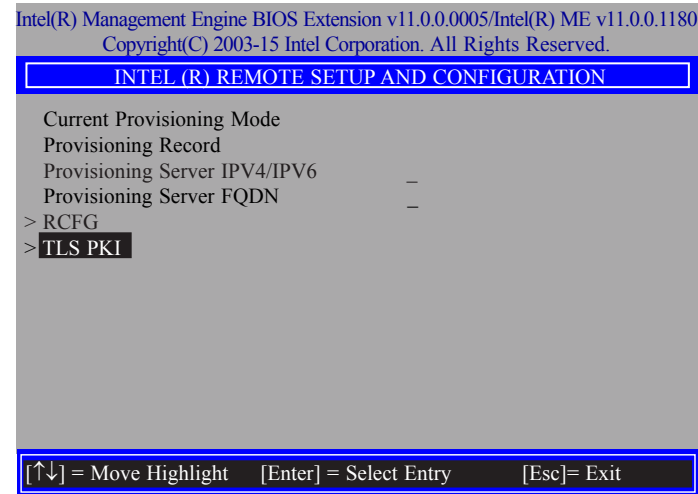

33. In the **Intel(R) Remote Setup And Configuration** menu, select **RCFG** then press Enter, and select **Start Configuration** then press enter.

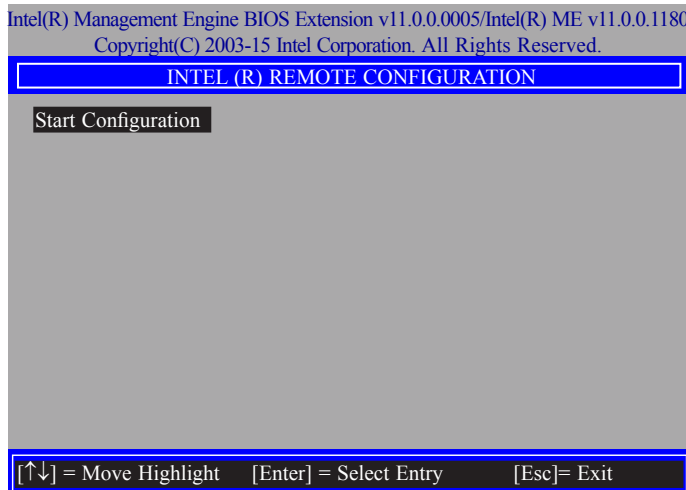

35. In the **Intel(R) Remote Configuration** menu, select **Remote Configuration\*\*** then press Enter, select **Enabled** or **Disabled** then press Enter.

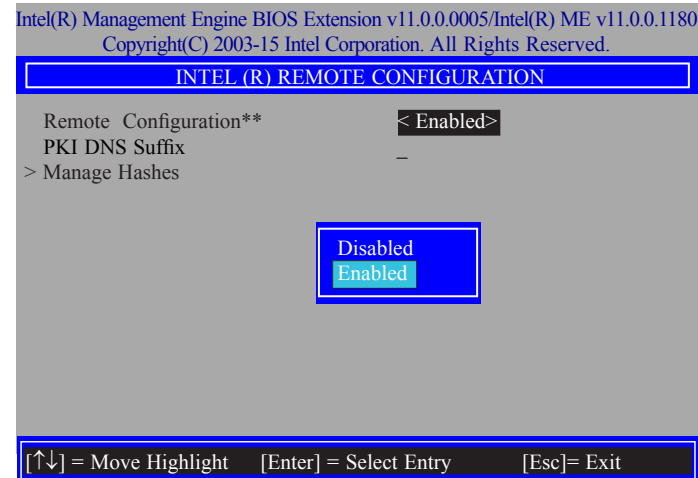

36. Select **PKI DNS Suffix**, Enter the PKI DNS Suffix then press Enter.

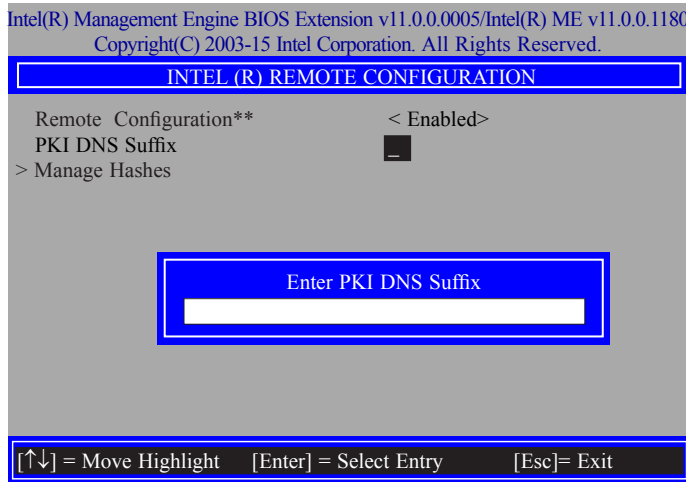

37. Select **Manage Hashes** then press Enter, and select one of hash name.

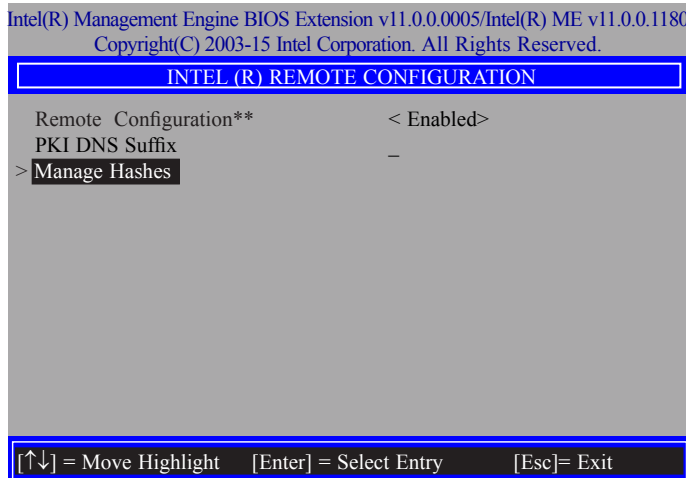

38. In the **Intel(R) AMT Configuration** menu, select **Power Control** then press Enter.

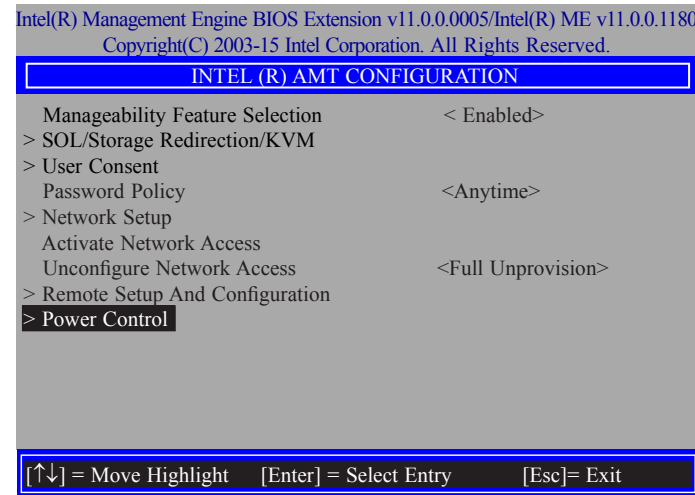

39. In the **Intel(R) AMT Power Control** menu, select **Intel(R) AMT ON in Host Sleep States** then press Enter. Select an option then press Enter.

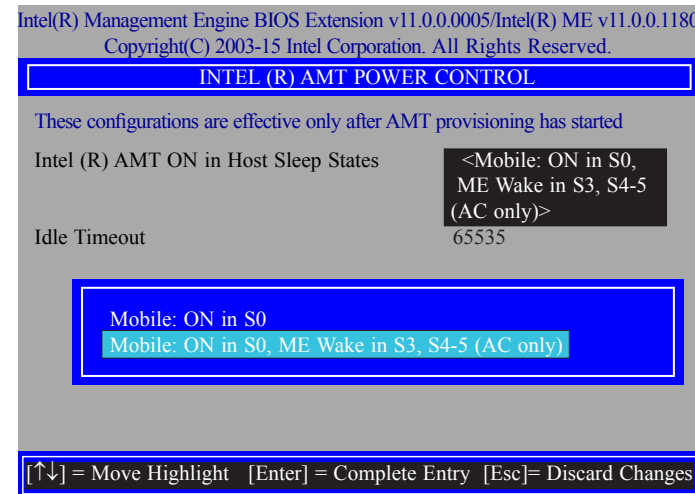

40. In the **Intel(R) AMT Power Control** menu, select **Idle Timeout** then press Enter. Enter the timeout value (1-65535).

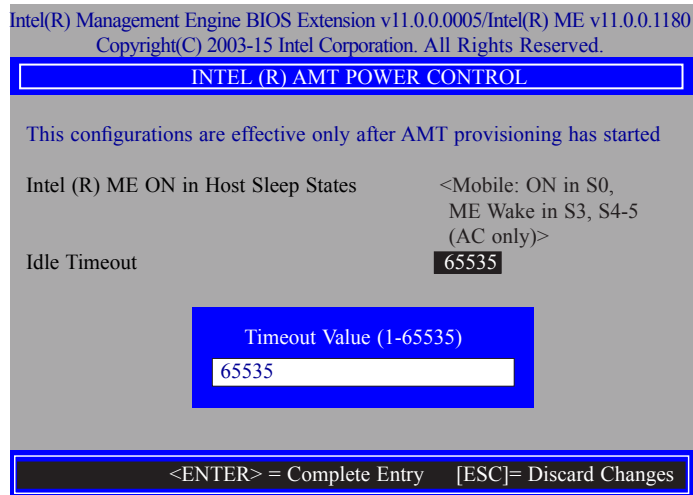

41. Select Previous Menu until you return to the **Main Menu**. Select **Exit** then press Enter. Type **Y** then press Enter.

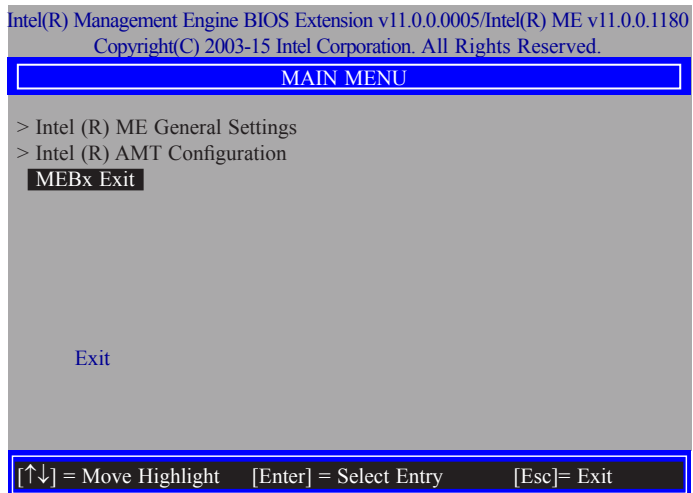

## Appendix A - Troubleshooting Checklist

### Troubleshooting Checklist

This chapter of the manual is designed to help you with problems that you may encounter with your personal computer. To efficiently troubleshoot your system, treat each problem individually. This is to ensure an accurate diagnosis of the problem in case a problem has multiple causes.

Some of the most common things to check when you encounter problems while using your system are listed below.

1. The power switch of each peripheral device is turned on.
2. All cables and power cords are tightly connected.
3. The electrical outlet to which your peripheral devices are connected is working. Test the outlet by plugging in a lamp or other electrical device.
4. The monitor is turned on.
5. The display's brightness and contrast controls are adjusted properly.
6. All add-in boards in the expansion slots are seated securely.
7. Any add-in board you have installed is designed for your system and is set up correctly.

### Monitor/Display

#### If the display screen remains dark after the system is turned on:

1. Make sure that the monitor's power switch is on.
2. Check that one end of the monitor's power cord is properly attached to the monitor and the other end is plugged into a working AC outlet. If necessary, try another outlet.
3. Check that the video input cable is properly attached to the monitor and the system's display adapter.
4. Adjust the brightness of the display by turning the monitor's brightness control knob.

#### The picture seems to be constantly moving.

1. The monitor has lost its vertical sync. Adjust the monitor's vertical sync.
2. Move away any objects, such as another monitor or fan, that may be creating a magnetic field around the display.
3. Make sure your video card's output frequencies are supported by this monitor.

#### The screen seems to be constantly wavering.

1. If the monitor is close to another monitor, the adjacent monitor may need to be turned off. Fluorescent lights adjacent to the monitor may also cause screen wavering.

### Power Supply

#### When the computer is turned on, nothing happens.

1. Check that one end of the AC power cord is plugged into a live outlet and the other end properly plugged into the back of the system.
2. Make sure that the voltage selection switch on the back panel is set for the correct type of voltage you are using.
3. The power cord may have a "short" or "open". Inspect the cord and install a new one if necessary.

### Floppy Drive

#### The computer cannot access the floppy drive.

1. The floppy diskette may not be formatted. Format the diskette and try again.
2. The diskette may be write-protected. Use a diskette that is not write-protected.
3. You may be writing to the wrong drive. Check the path statement to make sure you are writing to the targeted drive.
4. There is not enough space left on the diskette. Use another diskette with adequate storage space.

## Hard Drive

### Hard disk failure.

1. Make sure the correct drive type for the hard disk drive has been entered in the BIOS.
2. If the system is configured with two hard drives, make sure the bootable (first) hard drive is configured as Master and the second hard drive is configured as Slave. The master hard drive must have an active/bootable partition.

### Excessively long formatting period.

If your hard drive takes an excessively long period of time to format, it is likely a cable connection problem. However, if your hard drive has a large capacity, it will take a longer time to format.

## Serial Port

### The serial device (modem, printer) doesn't output anything or is outputting garbled characters.

1. Make sure that the serial device's power is turned on and that the device is on-line.
2. Verify that the device is plugged into the correct serial port on the rear of the computer.
3. Verify that the attached serial device works by attaching it to a serial port that is working and configured correctly. If the serial device does not work, either the cable or the serial device has a problem. If the serial device works, the problem may be due to the onboard I/O or the address setting.
4. Make sure the COM settings and I/O address are configured correctly.

## Keyboard

### Nothing happens when a key on the keyboard was pressed.

1. Make sure the keyboard is properly connected.
2. Make sure there are no objects resting on the keyboard and that no keys are pressed during the booting process.

## System Board

1. Make sure the add-in card is seated securely in the expansion slot. If the add-in card is loose, power off the system, re-install the card and power up the system.
2. Check the jumper settings to ensure that the jumpers are properly set.
3. Verify that all memory modules are seated securely into the memory sockets.
4. Make sure the memory modules are in the correct locations.
5. If the board fails to function, place the board on a flat surface and seat all socketed components. Gently press each component into the socket.
6. If you made changes to the BIOS settings, re-enter setup and load the BIOS defaults.