



# RPP171\_RPP173

## Mini-ITX Industrial Motherboard User's Manual

## Copyright

This publication contains information that is protected by copyright. No part of it may be reproduced in any form or by any means or used to make any transformation/adaptation without the prior written permission from the copyright holders.

This publication is provided for informational purposes only. The manufacturer makes no representations or warranties with respect to the contents or use of this manual and specifically disclaims any express or implied warranties of merchantability or fitness for any particular purpose. The user will assume the entire risk of the use or the results of the use of this document. Further, the manufacturer reserves the right to revise this publication and make changes to its contents at any time, without obligation to notify any person or entity of such revisions or changes.

Changes after the publication's first release will be based on the product's revision. The website will always provide the most updated information.

© 2024. All Rights Reserved.

## Trademarks

Product names or trademarks appearing in this manual are for identification purpose only and are the properties of the respective owners.

## FCC and DOC Statement on Class B

This equipment has been tested and found to comply with the limits for a Class B digital device, pursuant to Part 15 of the FCC rules. These limits are designed to provide reasonable protection against harmful interference when the equipment is operated in a residential installation. This equipment generates, uses and can radiate radio frequency energy and, if not installed and used in accordance with the instruction manual, may cause harmful interference to radio communications. However, there is no guarantee that interference will not occur in a particular installation. If this equipment does cause harmful interference to radio or television reception, which can be determined by turning the equipment off and on, the user is encouraged to try to correct the interference by one or more of the following measures:

- Reorient or relocate the receiving antenna.
- Increase the separation between the equipment and the receiver.
- Connect the equipment into an outlet on a circuit different from that to which the receiver is connected.
- Consult the dealer or an experienced radio TV technician for help.

## Notice:

1. The changes or modifications not expressly approved by the party responsible for compliance could void the user's authority to operate the equipment.
2. Shielded interface cables must be used in order to comply with the emission limits.

# Table of Contents

Chapter 1 - Introduction.....	6
Specifications .....	6
Block Diagram .....	8
Dimension .....	8
Chapter 2 - Hardware Installation.....	9
Board Layout.....	9
Installing the heat sink.....	10
Installing the Heat Sink .....	10
Jumper Settings .....	11
Clear CMOS Data (SW1) .....	11
Inverter Panel Power Select (DPJP2).....	11
VCC Panel Power Select (DPJP3) .....	12
Panel Backlight ON Level Select (DPJP4).....	12
COM4 DIO & COM4 Select (JP1).....	13
COM3 Power Select (JP2) .....	13
M.2 A Key Panel Power (DPJP5).....	14
BKL , VDDEN Jumper (DPJP6) .....	14
Pin Assignment .....	15
RTC Battery (J1) .....	15
Case Open (J24).....	15
System Fan (CN25) .....	16
CPU Fan (CN24) .....	16
UART Header (Debug) (J21) .....	17
SMBus (J16) .....	17
SATA POWER (J18) .....	18
SATA POWER (J19) .....	18
SATA0 (J12) .....	19
SATA1 (J13) .....	19
Backlight CON (DPJ1) .....	20
DIO (J15) .....	20
Front Audio (AUJ1).....	21
USB2.0 Pin Header (UBJ1) .....	21
USB2.0 Pin Header (UBJ2) .....	22
COM3 Power Select (JP2).....	22
COM1 RS232/RS422/RS485 (TSJ1).....	23
COM2 RS232/RS422/RS485 (TSJ2).....	23
COM3 RS232 (J5).....	24
COM4 RS232 (J6).....	24
Front Panel (J17).....	25
COM4 DIO & COM4 Select (JP1) .....	25
Expansion Slots.....	26
Installing the M.2 Module .....	26
Chapter 3 - BIOS Settings.....	28
Overview .....	28
Main.....	29
Advanced .....	29
CPU Configuration.....	30
Power & Performance .....	30
Power & Performance ▶ CPU- Power Management Control .....	31
Power & Performance ▶ GT- Power Management Control .....	31
PCH-FW Configuration.....	32
Trusted Computing.....	32
IT8786 Super IO Configuration.....	33
IT8786 Super IO Configuration ▶ Serial Port 1, 2 Configuration .....	33

IT8786 Super IO Configuration ▶ Serial Port 3, 4 Configuration .....	34
IT8786 HW Monitor .....	34
IT8786 HW Monitor ▶ Smart FAN Function .....	35
IT8786 HW Monitor ▶ Smart FAN Function ▶ CPU FAN Setting.....	35
IT8786 HW Monitor ▶ Smart FAN Function ▶ SYS_FAN Setting.....	35
Serial Port Console Redirection .....	36
Serial Port Console Redirection ▶ Console Redirection Settings.....	37
ACPI Settings .....	38
Network Stack Configuration.....	38
DFI WDT Configuration.....	39
USB Power Control .....	40
Tls Auth Configuration .....	40
Chipset .....	41
System Agent (SA) Configuration .....	41
PCH-IO Configuration .....	42
PCH-IO Configuration ▶ PCI Express Configuration .....	42
PCH-IO Configuration ▶ SATA Configuration .....	43
PCH-IO Configuration ▶ HD Audio Configuration .....	43
Security .....	44
Secure Boot.....	44
Boot .....	45
Save & Exit .....	45
Updating the BIOS .....	46
Notice: BIOS SPI ROM.....	46

## About this Manual

This manual can be downloaded from the website.

The manual is subject to change and update without notice, and may be based on editions that do not resemble your actual products. Please visit our website or contact our sales representatives for the latest editions.

## Warranty

1. Warranty does not cover damages or failures that occur from misuse of the product, inability to use the product, unauthorized replacement or alteration of components and product specifications.
2. The warranty is void if the product has been subjected to physical abuse, improper installation, modification, accidents or unauthorized repair of the product.
3. Unless otherwise instructed in this user's manual, the user may not, under any circumstances, attempt to perform service, adjustments or repairs on the product, whether in or out of warranty. It must be returned to the purchase point, factory or authorized service agency for all such work.
4. We will not be liable for any indirect, special, incidental or consequential damages to the product that has been modified or altered.

## Static Electricity Precautions

It is quite easy to inadvertently damage your PC, system board, components or devices even before installing them in your system unit. Static electrical discharge can damage computer components without causing any signs of physical damage. You must take extra care in handling them to ensure against electrostatic build-up.

1. To prevent electrostatic build-up, leave the system board in its anti-static bag until you are ready to install it.
2. Wear an antistatic wrist strap.
3. Do all preparation work on a static-free surface.
4. Hold the device only by its edges. Be careful not to touch any of the components, contacts or connections.
5. Avoid touching the pins or contacts on all modules and connectors. Hold modules or connectors by their ends.



### Important:

Electrostatic discharge (ESD) can damage your processor, disk drive and other components. Perform the upgrade instruction procedures described at an ESD workstation only. If such a station is not available, you can provide some ESD protection by wearing an antistatic wrist strap and attaching it to a metal part of the system chassis. If a wrist strap is unavailable, establish and maintain contact with the system chassis throughout any procedures requiring ESD protection.

## Safety Measures

- To avoid damage to the system, use the correct AC input voltage range.
- To reduce the risk of electric shock, unplug the power cord before removing the system chassis cover for installation or servicing. After installation or servicing, cover the system chassis before plugging the power cord.

## About the Package

The package contains the following items. If any of these items are missing or damaged, please contact your dealer or sales representative for assistance.

- 1 RPP171/RPP173 Motherboard
- 1 COM port cable with bracket (Length: 250mm, 1 x COM ports)
- 1 Serial ATA data with power cable (Length: 300mm)
- 4 M.2 screw/standoff
- 1 I/O Shield
- 1 Cooler/Heat sink
  - (Wide/Normal Temp. -Cooler for 28W) (Default)
  - (Wide Temp. Fanless HS for 15W) (By request)
  - (Normal Temp. Fanless HS for 15W) (By request)

The board and accessories in the package may not come similar to the information listed above. This may differ in accordance with the sales region or models in which it was sold. For more information about the standard package in your region, please contact your dealer or sales representative.

## Before Using the System Board

When installing the system board in a new system, you will need at least the following internal components.

- Memory module
- Storage device such as a hard disk drive.
- Power supply

External system peripherals may also be required for navigation and display, including at least a keyboard, a mouse and a video display monitor.

## Chapter 1 - Introduction

### ► Specifications

SYSTEM	Processor	13th Generation Intel® Core™ Processors Intel® Core™ i7-1365UE (10 Cores, 12M Cache, up to 4.9 GHz); 15~28W Intel® Core™ i5-1345UE (10 Cores, 12M Cache, up to 4.6 GHz); 15~28W Intel® Core™ i3-1315UE (6 Cores, 10M Cache, up to 4.5 GHz); 15~28W Intel® Processor U300E (Formerly Pentium) (5 Cores, 24M Cache, up to 4.3 GHz); 15~28W
	Memory	One 262-pin SODIMM up to 64GB Dual Channel DDR5 5200MHz
	BIOS	AMI SPI 256Mbit
GRAPHICS	Controller	Intel® Iris® Xe Graphics for i7/i5 CPU Intel® UHD Graphics for i3 CPU
	Feature	OpenGL 4.6, DirectX 12.1, OpenCL 3.0, OpenGL 4.6 HW Decode: AVC/H.264, MPEG2, VC1/WMV9, JPEG/MJPEG, HEVC/H265, VP8, VP9 HW Encode: MPEG2, AVC/H264, JPEG, HEVC/H265, VP8, VP9
	Display	2 x HDMI/DP Combo (Auto detect) HDMI: resolution up to 4096x2160 @30Hz DP: resolution up to 4096x2304 @60Hz USB Type C (DP alt-mode/USB3.2 Gen2/PD 15W): resolution up to 4096x2304 @60Hz (HBR2)
	Quad Displays	HDMI + DP + USB Type C (DP alt-mode/USB3.2 Gen2/PD 15W) + M2A-Display (optional)
EXPANSION	Interface	1 x PCIe Gen 4 x4 1 x M.2 2242/2280 M Key (PCIe Gen4x4, support NVMe ) 1 x M.2 2242/3042/3052 B Key (PCIe Gen3x1, USB3.2 Gen2, USB2.0, selected by BIOS) 1 x M.2 2230 E Key (PCIe Gen3x1 and USB2.0, support Intel® CNVi) 1 x M.2 3042 A Key support DFI M2A-display module (opt. MOQ required)
AUDIO	Audio Codec	Realtek ALC888S
ETHERNET	Controller	LAN1/2: i226V/IT (10/100/1000/2.5G speeds) LAN3(vPro): i226LM/IT (10/100/1000/2.5G speeds)
REAR I/O	Ethernet	Up to 3 x 2.5GHz RJ45 (LAN 3 colayout with internal vertical RJ45 by option)
	USB	4 x USB 3.2 Gen2 1 x USB Type C (DP alt-mode/USB3.2 Gen2/PD 15W)
	Display	2 x DP/HDMI combo (Auto detect)

INTERNAL I/O	Serial	2 x RS-232/422/485 (2.0mm pitch) 1 x RS-232 with power (2.0mm pitch) 1 x RS-232 (2.0mm pitch) colay with DIO-4bit (JP1)
	USB	4 x USB 2.0 (2.0mm pitch)
	Display	1 x M.2 A key, support M2A-Display (eDP/LVDS/VGA/HDMI/DP) by optional
	Audio	1 x Line-out/Mic-in
	SATA	2 x SATA 3.0
	DIO	1 x 8-bit DIO
	SMBus	1 x SMBus
WATCHDOG TIMER	Output & Interval	System Reset, Programmable via Software from 1 to 255 Seconds
SECURITY	TPM	dTPM (default) fTPM (option)
POWER	Type	RPP171: Single 12VDC RPP173: Wide Range 9~36VDC
	Connector	DC-in Jack Right Angle Connector (4-pin) (available upon request) Straightl Type Connector (4-pin) (available upon request)
	Consumption	Idle: RPP171-IE-1370PRE 28W: 12V@ 0.81A (9.72W) Max: RPP171-IE-1370PRE 28W: 12V@ 8.83A (105.96W) Idle: RPP171-IE-1365UE 15W: 12V@ 0.75 (9W) Max: RPP171-IE-1365UE 15W: 12V@ 8.83 (99.96W)
	RTC Battery	CR2032 Coin Cell
OS SUPPORT	Microsoft	Windows IoT Enterprise 10 LTSB Windows 11
	Linux	Linux
ENVIRONMENT	Temperature	Operating: -5 to 65°C, -20 to 70°C Storage: -40 to 85°C
	Humidity	Operating: 5 to 90% RH Storage: 5 to 90% RH
	MTBF	RPP173-IE-1365UE 442,970 hrs @ 25°C; 271,011 hrs @ 45°C; 160, 178,357 @ 60°; 133,264 hrs @ 70°C; Calculation model: Telcordia Issue 4 Environment: GB, GC – Ground Benign, Controlled
MECHANISM	Dimensions	Mini-ITX Form Factor: 170mm (6.7") x 170mm (6.7")
	Height	PCB: 1.6mm Top Side: 20mm Bottom Side: 3mm
STANDARDS AND CERTIFICATIONS	Certifications	CE, FCC, RoHS

► Block Diagram

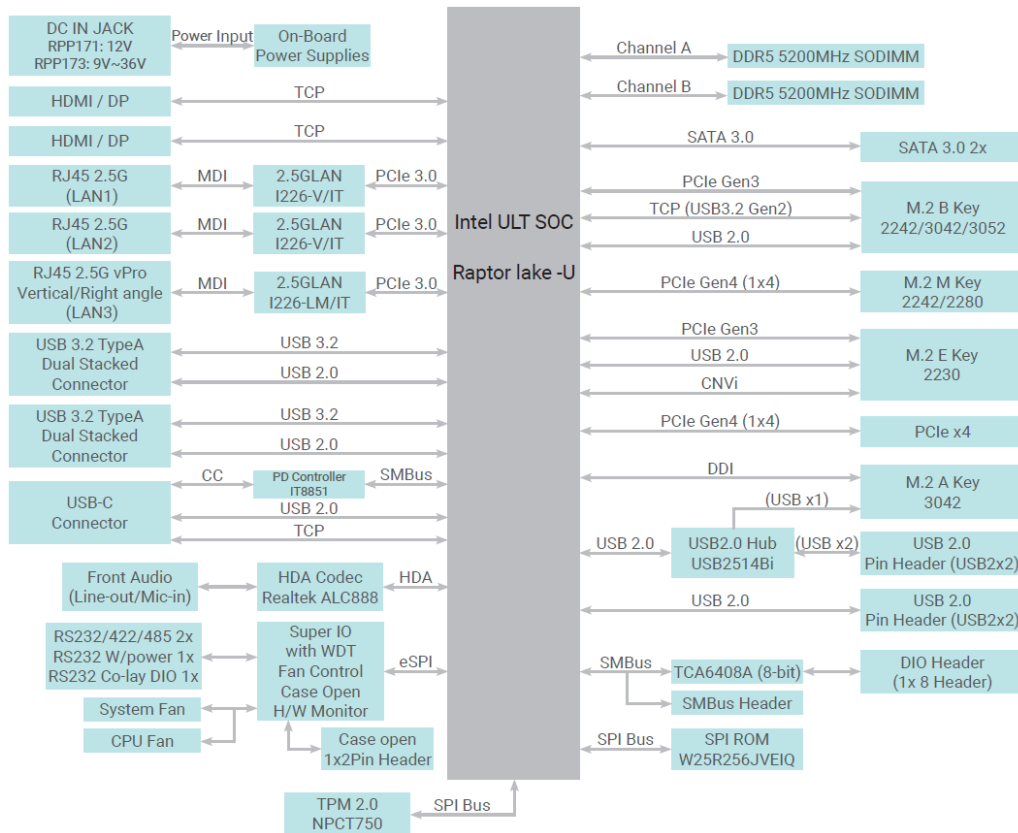

► Dimension

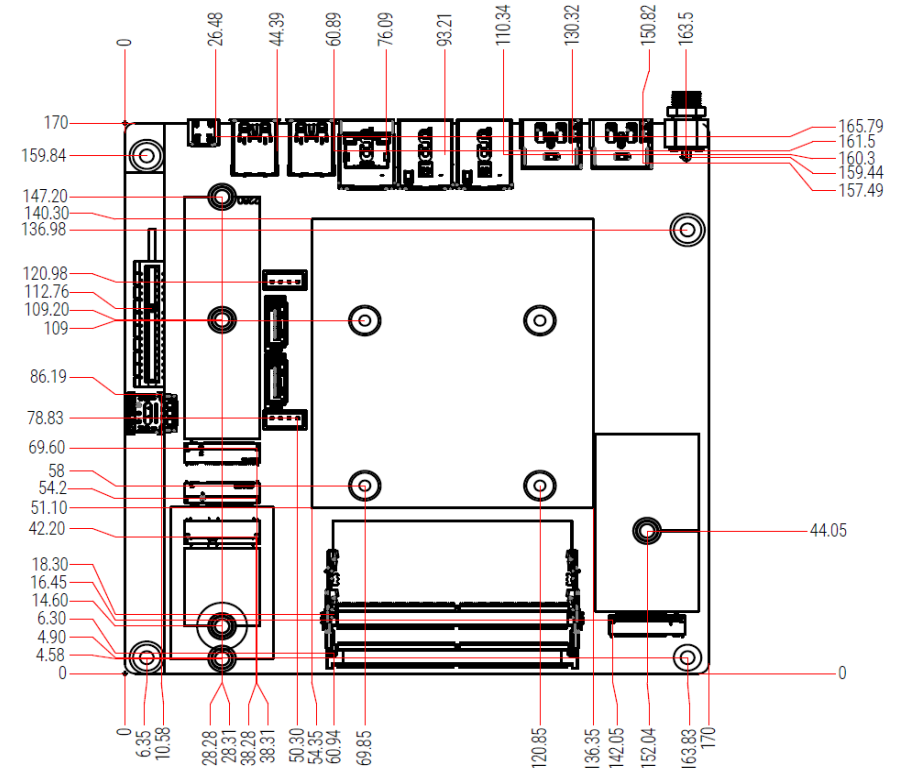



## Chapter 2 - Hardware Installation

### ► Board Layout

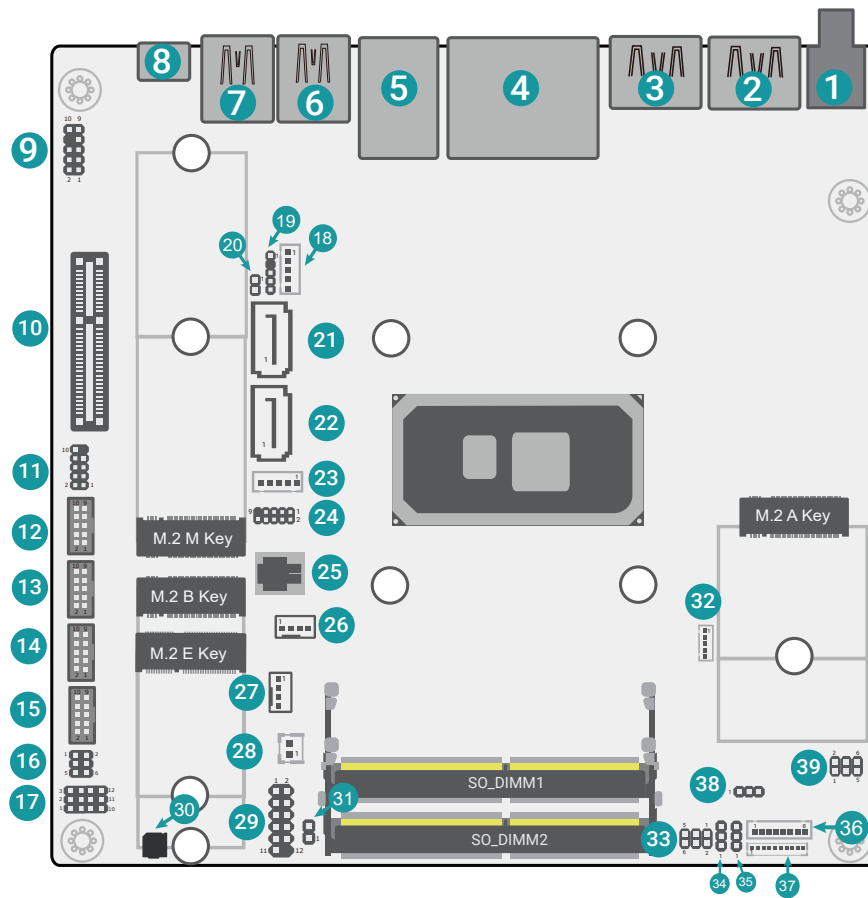

- |                           |                                    |
|---------------------------|------------------------------------|
| 1 DC-in                   | 21 SATA0                           |
| 2 DP/HDMI                 | 22 SATA1                           |
| 3 DP/HDMI                 | 23 SATA Power                      |
| 4 LAN1 & LAN2             | 24 USB2.0                          |
| 5 LAN3                    | 25 SPI                             |
| 6 USB3.2 Gen2             | 26 CPU Fan                         |
| 7 USB3.2 Gen2             | 27 System Fan                      |
| 8 USB Type C              | 28 RTC Battery                     |
| 9 Front Audio             | 29 Front Panel                     |
| 10 PCIe Gen 4x4           | 30 Buzzer                          |
| 11 USB2.0                 | 31 Case Open                       |
| 12 COM1                   | 32 SMBus                           |
| 13 COM2                   | 33 VCC Panel Power Select          |
| 14 COM3                   | 34 Inverter Panel Power Select     |
| 15 COM4                   | 35 Panel Backlight ON Level Select |
| 16 COM3 Power Select      | 36 Backlight CON                   |
| 17 COM4 DIO & COM4 Select | 37 DIO                             |
| 18 SATA Power             | 38 M.2 A Key Panel Power           |
| 19 UART Header (Debug)    | 39 BKL , VDDEN Jumper              |
| 20 Clear CMOS Data        |                                    |

## ► Installing the heat sink

### Installing the Heat Sink

The CPU must be kept cool by using a heat sink, otherwise the CPU will overheat damaging both the CPU and system board.

1. Before you install the fan / heat sink, you must apply a thermal paste onto the top of the CPU. The thermal paste is usually supplied when you purchase the fan / heat sink assembly. Do not spread the paste all over the surface. When you later place the heat sink on top of the CPU, the compound will disperse evenly.

Some heat sinks come with a patch of preapplied thermal paste. Do not apply thermal paste if the fan / heat sink already has a patch of thermal paste on its underside. Peel the strip that covers the paste before you place the fan / heat sink on top of the CPU.

2. Place the heat sink on top of the CPU. The 4 spring screws around the heat sink, which are used to secure the heat sink onto the system board, must match the 4 mounting holes around the board.
3. Screw tight two of the spring screws at opposite corners into the mounting holes. And then proceed with the other two spring screws.

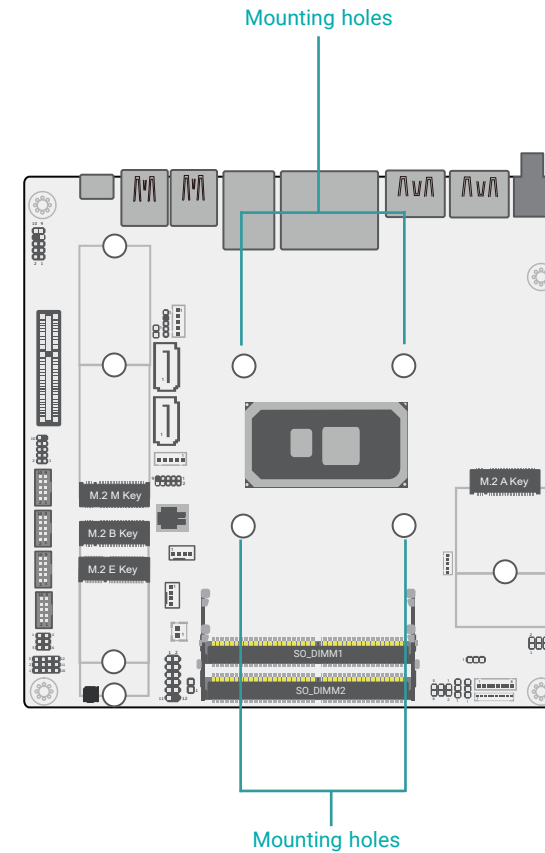

► Jumper Settings

Clear CMOS Data (SW1)

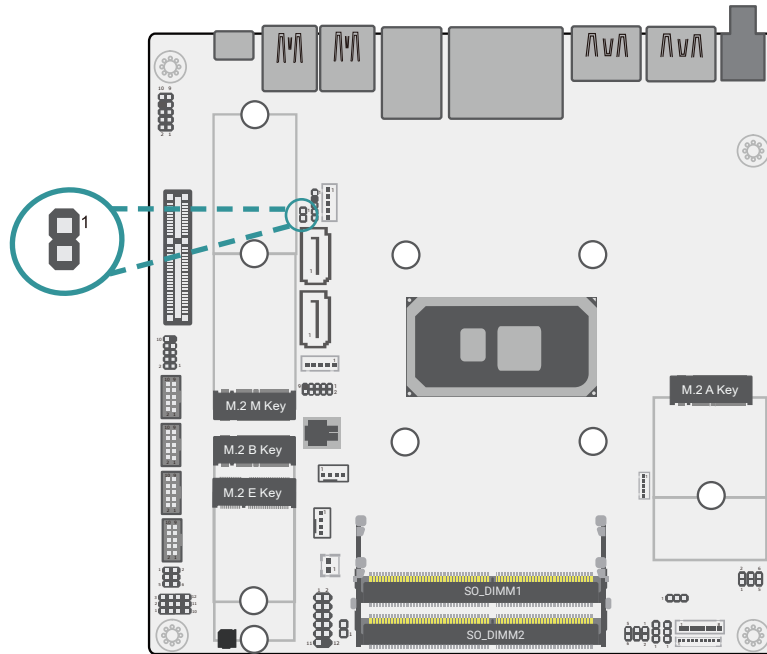

- 1-2 Open: Normal (Default)
- 1-2 Short: Clear CMOS Data

Inverter Panel Power Select (DPJP2)

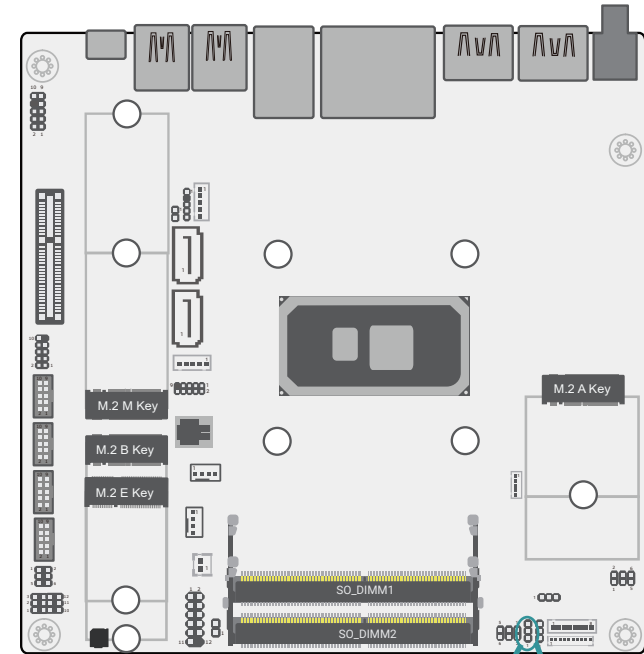

- 1-2 Short: 12V
- 2-3 Short: 5V (Default)

VCC Panel Power Select (DPJP3)

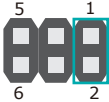
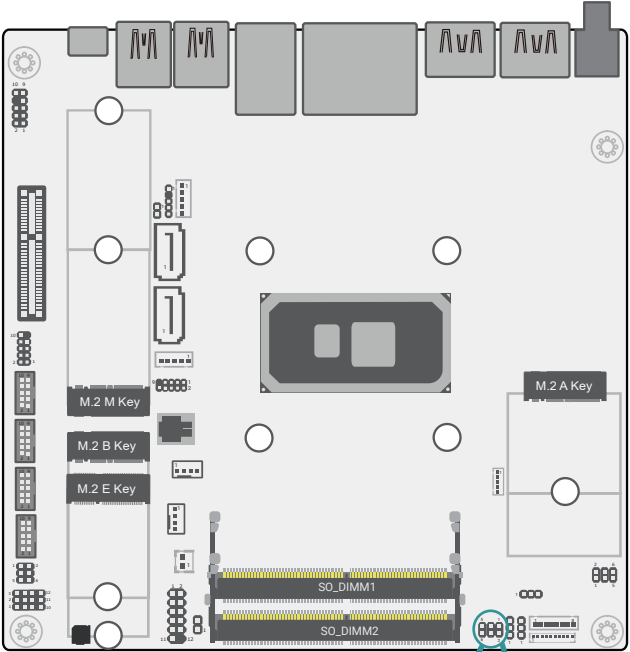

■ 1-2 Short: 12V

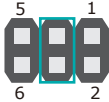

■ 3-4 Short: 5V



■ 5-6 Short: 3V3 (Default)

Panel Backlight ON Level Select (DPJP4)

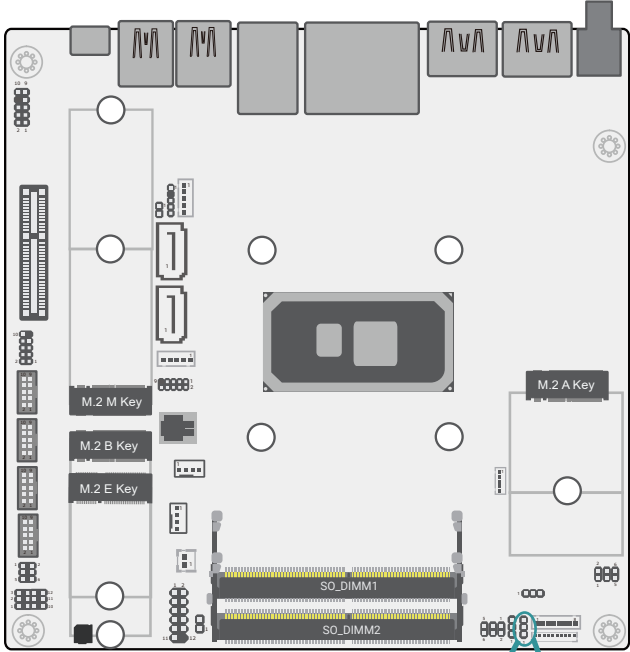

■ 1-2 Short: 3V3 (Default)



■ 2-3 Short: 5V

COM4 DIO & COM4 Select (JP1)

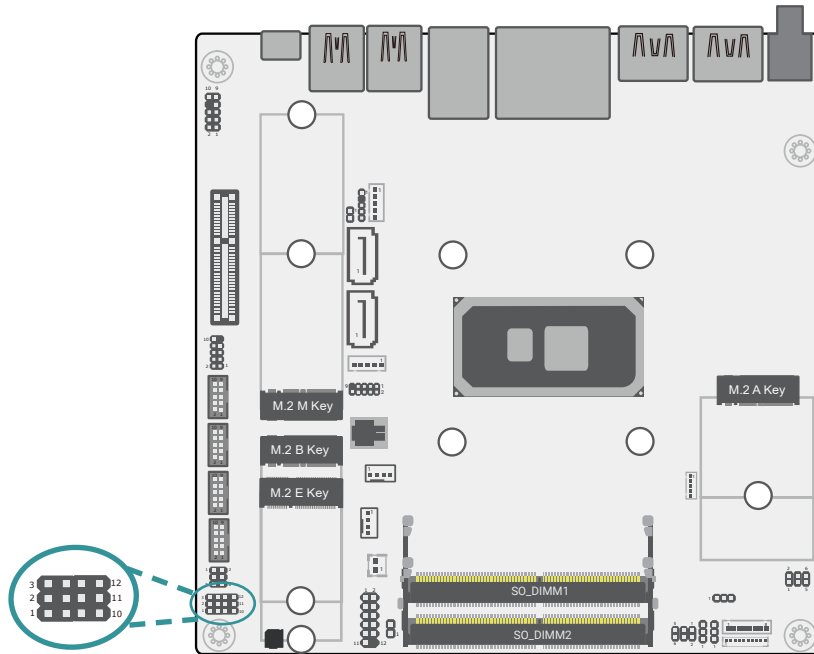

  
 ■ 1-2,4-5,7-8,10-11 Short:  
 COM Port Function (Default)

  
 ■ 2-3,5-6,8-9,11-12 Short:  
 4bit DIO Function

COM3 Power Select (JP2)

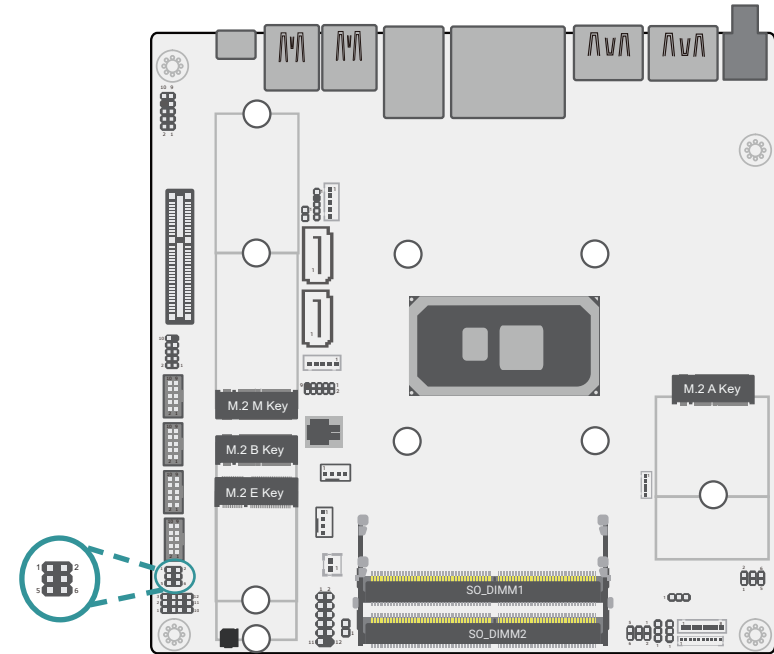

  
 ■ 1-3, 2-4 Short:  
 RS232 Standard (Default)

  
 ■ 3-5, 4-6 Short:  
 RS232 with Power

M.2 A Key Panel Power (DPJP5)

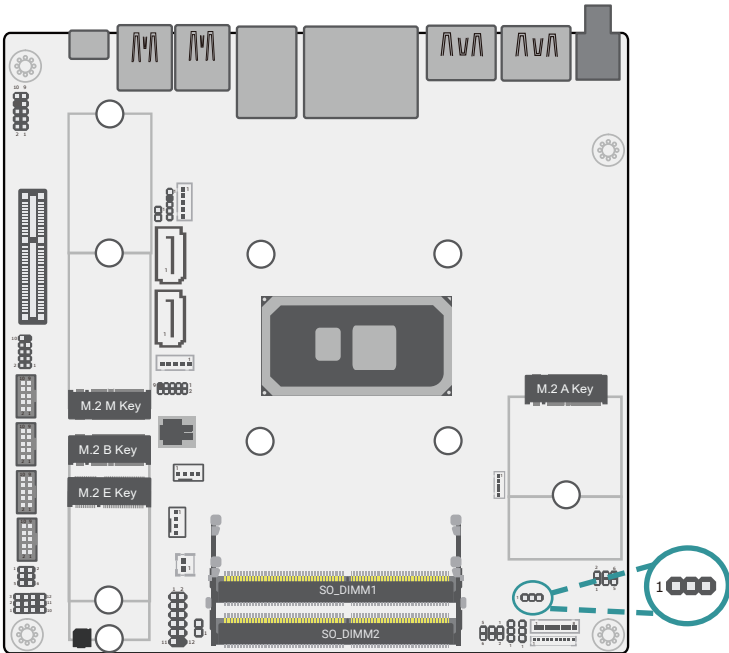

■ 1-2 Short: Panel Power



■ 2-3 Short: NC

BKL , VDDEN Jumper (DPJP6)

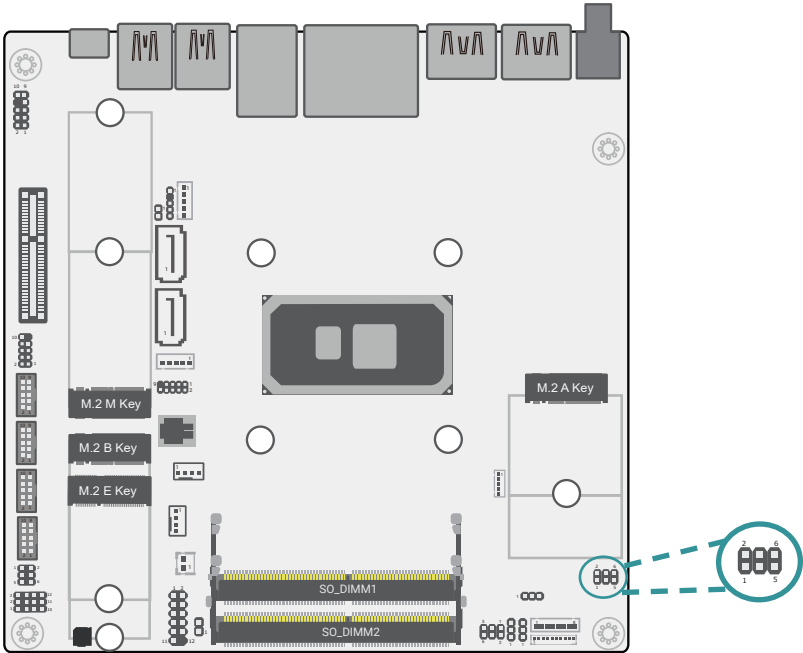

■ 1-3, 2-4 Short: LVDS



■ 3-5, 4-6 Short: eDP

► Pin Assignment

RTC Battery (J1)

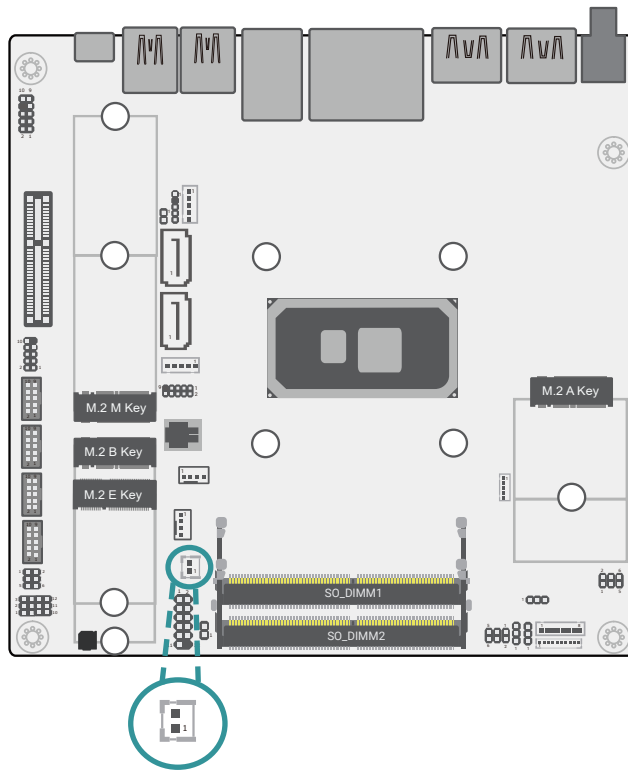

Pin	Assignment
1	V_BAT
2	GND

Case Open (J24)

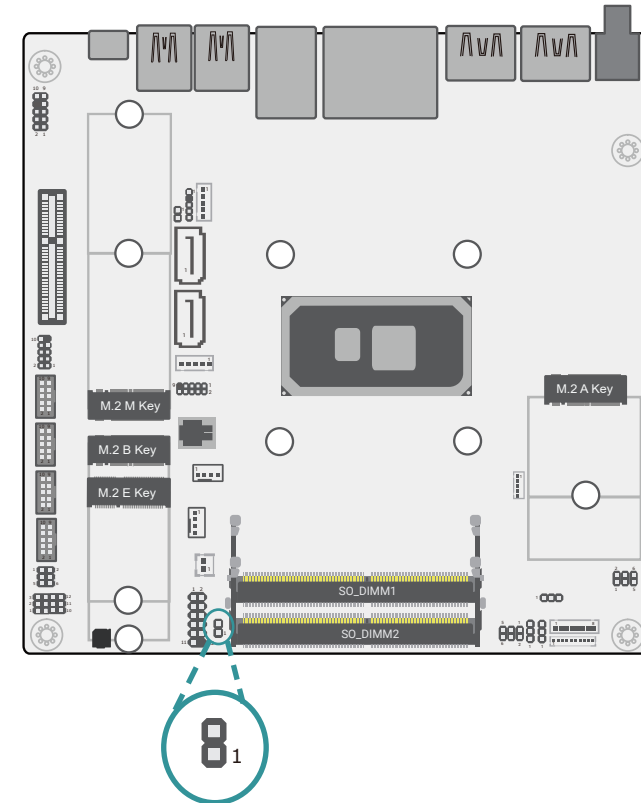

Pin	Assignment
1	Case Open-
2	GND

System Fan (CN25)

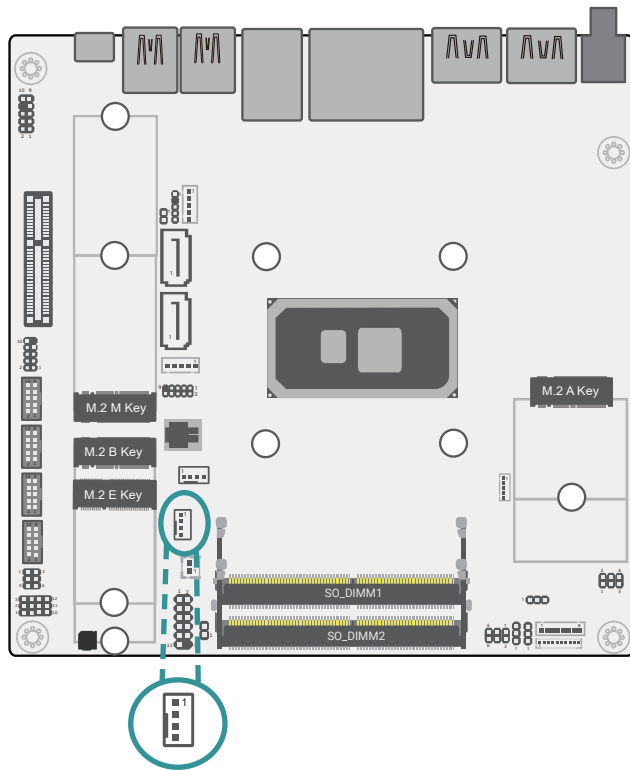

Pin	Assignment
1	GND
2	+12V
3	RPM
4	PWM

CPU Fan (CN24)

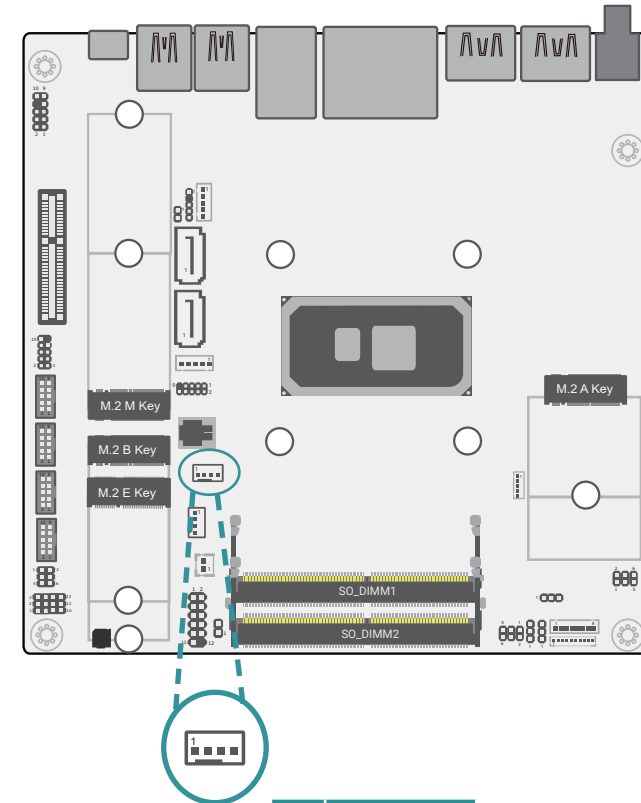

Pin	Assignment
1	GND
2	+12V
3	RPM
4	PWM



UART Header (Debug) (J21)

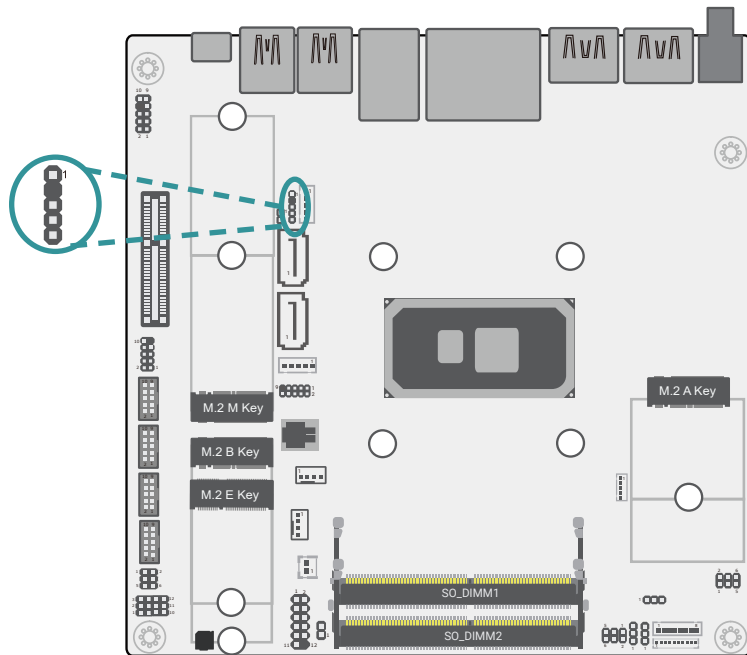

Pin	Assignment
1	GND
2	NC
3	3V3SB
4	DEBUG_UART_TX
5	DEBUG_UART_RX

SMBus (J16)

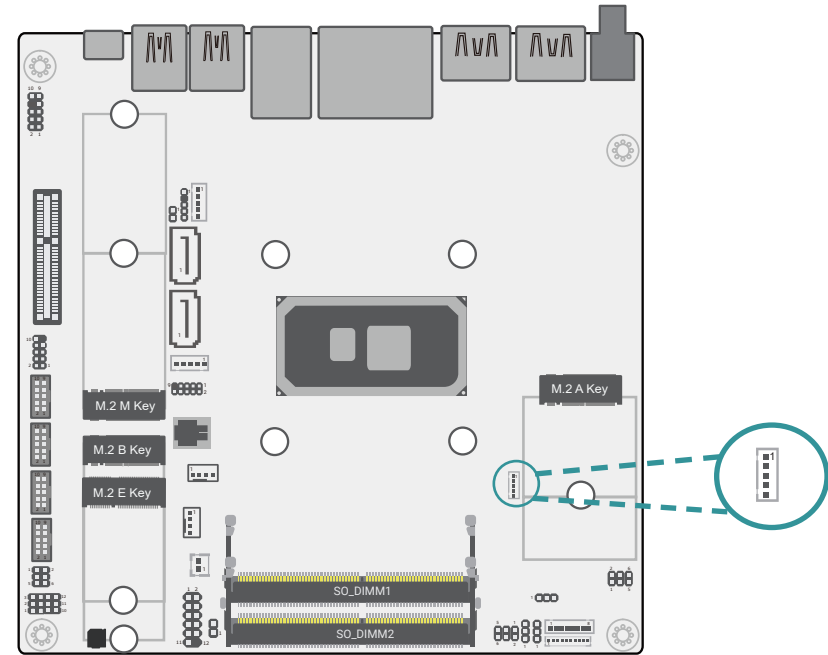

Pin	Assignment
1	3V3SB
2	GND
3	SMB_CLK_RESUME
4	SMB_DATA_RESUME
5	SMB_ALERT#

SATA POWER (J18)

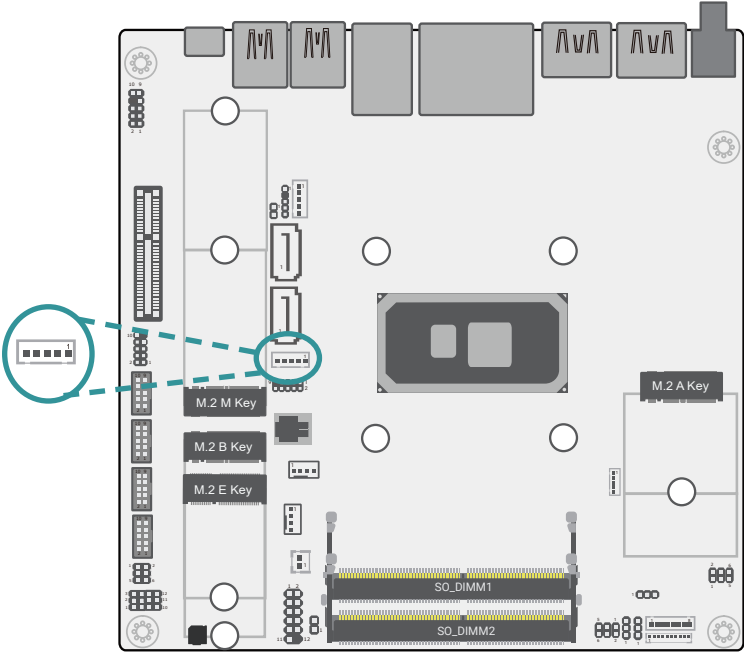

Pin	Assignment
1	5V
2	5V
3	12V
4	GND
5	GND

SATA POWER (J19)

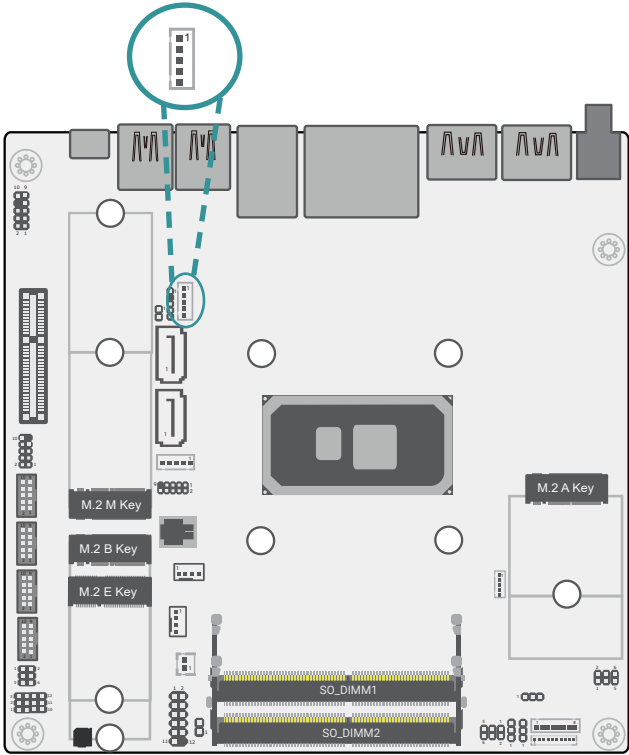

Pin	Assignment
1	5V
2	5V
3	12V
4	GND
5	GND

SATA0 (J12)

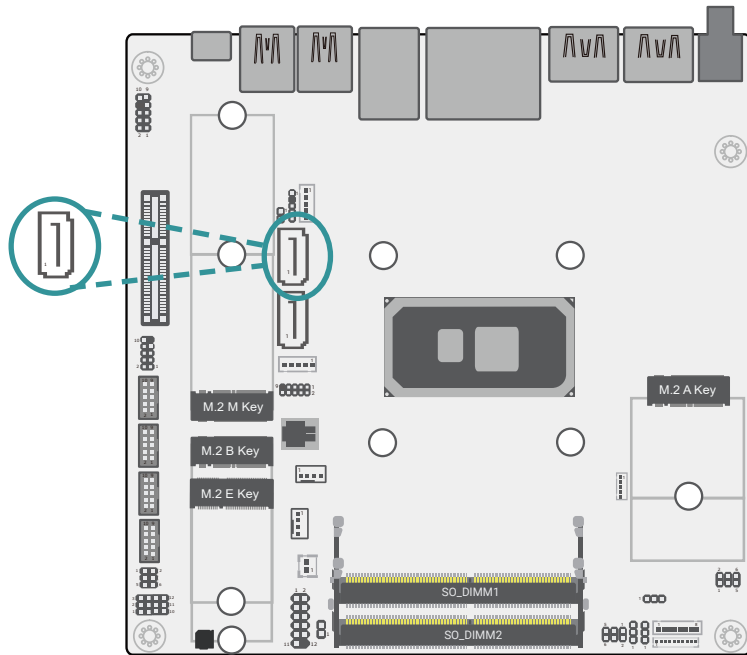

Pin	Assignment
1	GND
2	TXP
3	TXN
4	GND
5	RXN
6	RXP
7	GND

SATA1 (J13)

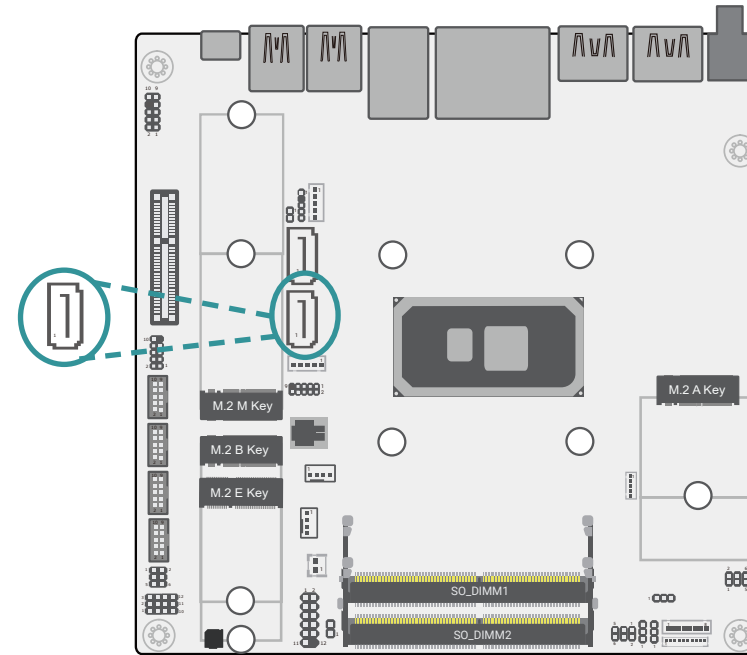

Pin	Assignment
1	GND
2	TXP
3	TXN
4	GND
5	RXN
6	RXP
7	GND

Backlight CON (DPJ1)

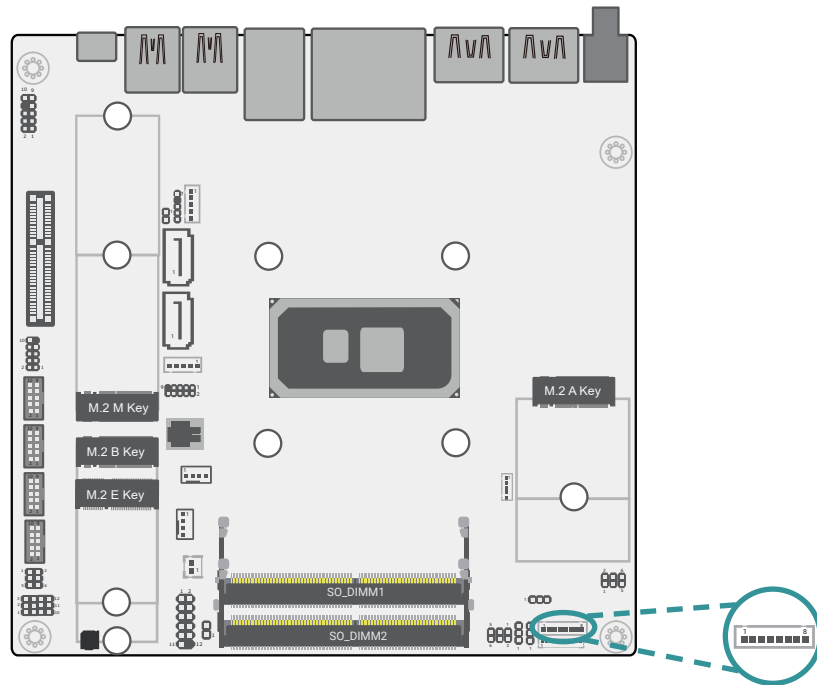

Pin	Assignment
1	GND
2	GND
3	PWM
4	VCC_PANEL_PWR
5	LVDS_3V3
6	BLONOFF
7	INV_PWR
8	INV_PWR

DIO (J15)

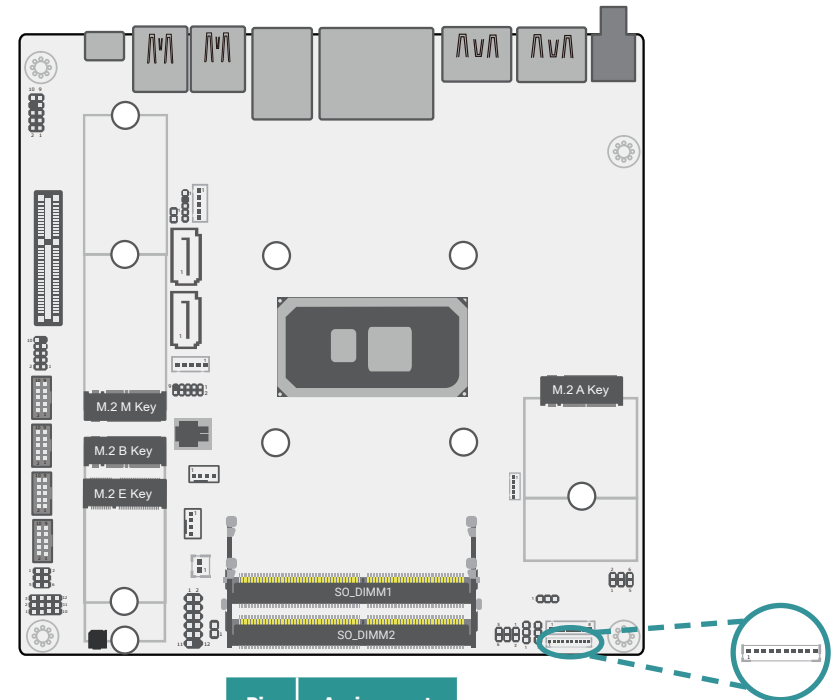

Pin	Assignment
1	D_IOA7
2	D_IOA6
3	D_IOA5
4	D_IOA4
5	D_IOA3
6	D_IOA2
7	D_IOA1
8	D_IOA0
9	5VSB
10	GND

Front Audio (AUJ1)

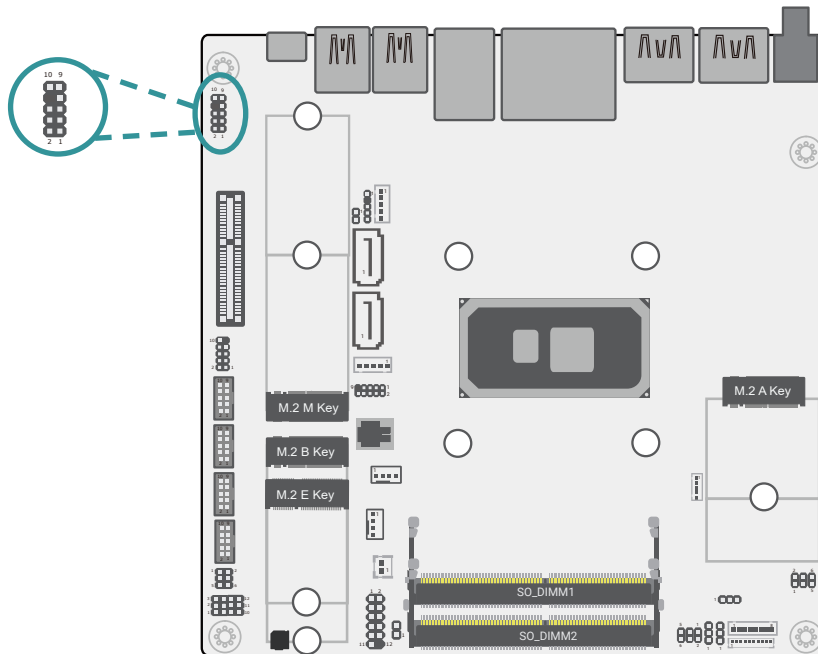

Pin	Assignment	Pin	Assignment
1	MIC2_L	2	GND
3	MIC2_R	4	NC
5	LINE2_R	6	MIC2_JD
7	GND	8	NC
9	LINE2_L	10	LINE2_JD

USB2.0 Pin Header (UBJ1)

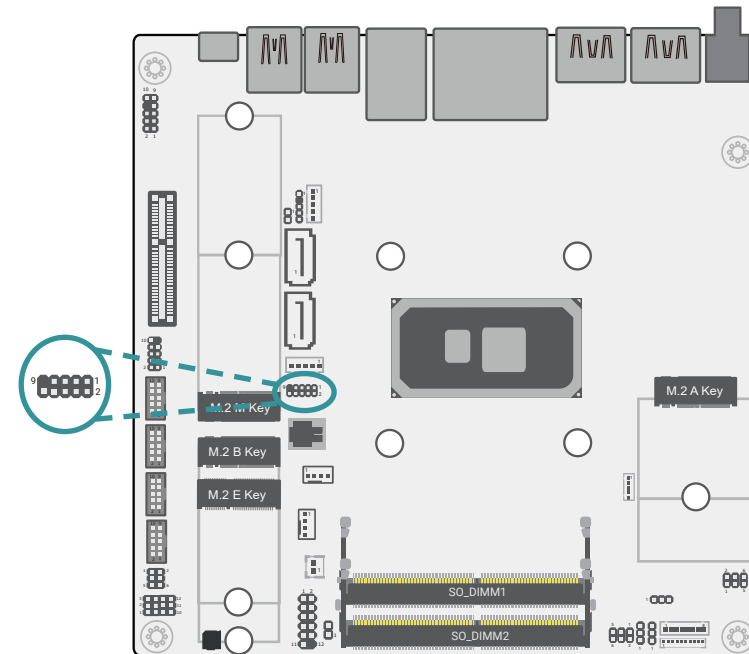

Pin	Assignment	Pin	Assignment
1	5V	2	5V
3	USB2_4_C_N	4	USB2_3_C_N
5	USB2_4_C_P	6	USB2_3_C_P
7	GND	8	GND
9	----	10	NC

USB2.0 Pin Header (UBJ2)

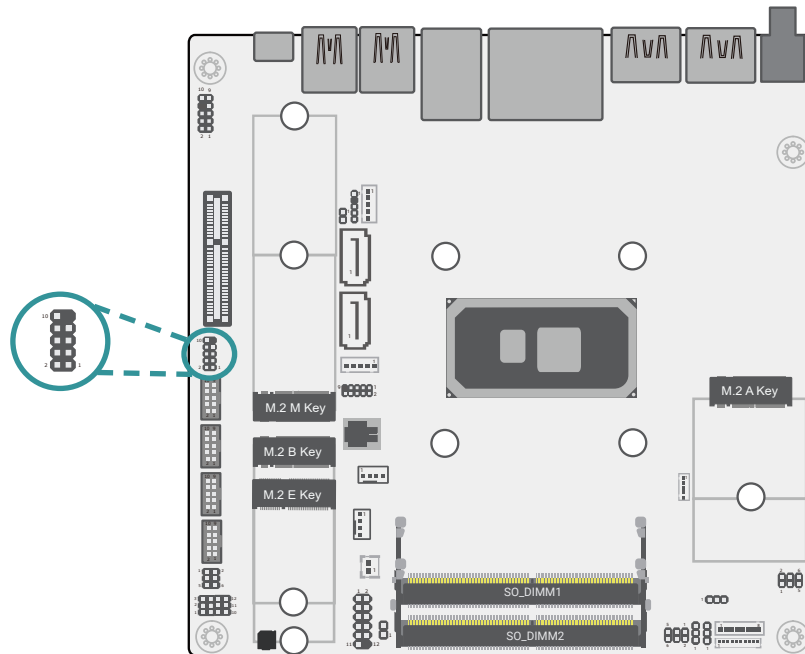

Pin	Assignment	Pin	Assignment
1	5V	2	5V
3	USB2_4_C_N	4	USB2_3_C_N
5	USB2_4_C_P	6	USB2_3_C_P
7	GND	8	GND
9	----	10	NC

COM3 Power Select (JP2)

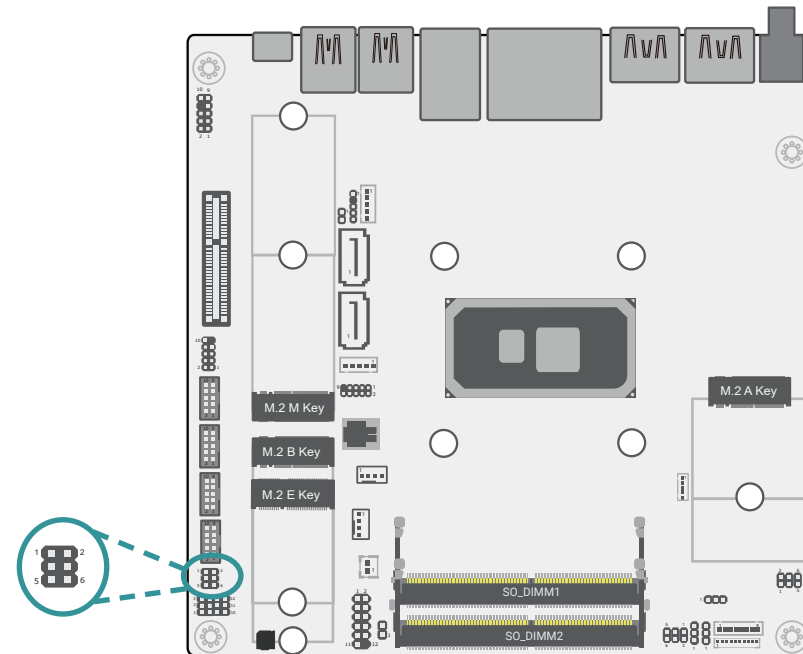

Pin	Assignment	Pin	Assignment
1	MRI-	2	MDCD-
3	X_MRI-	4	X_MDCD-
5	5V	6	12V

COM1 RS232/RS422/RS485 (TSJ1)

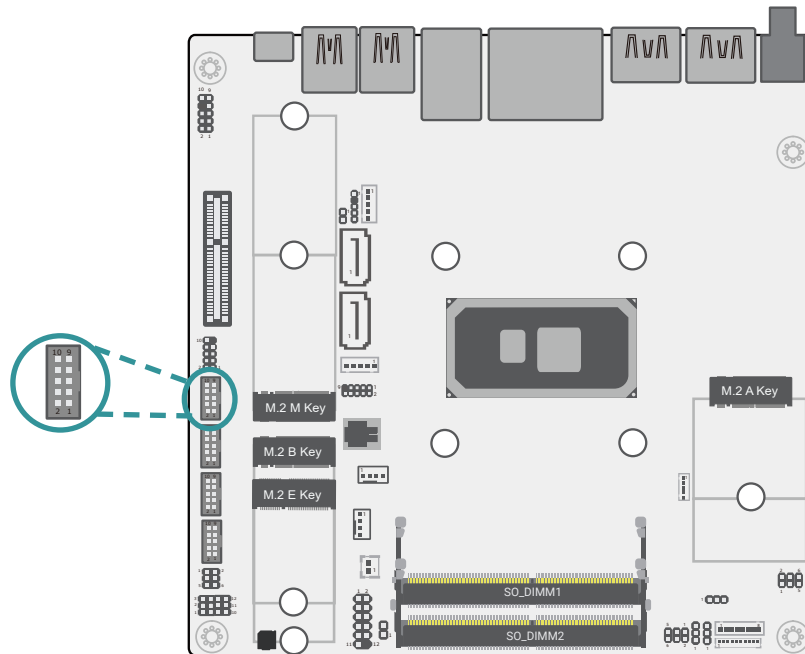

Pin	RS232	RS422 Full Duplex	RS485
1	DCD-	TXD-	Data-
2	RD	TXD+	Data+
3	TD	RXD+	N.C
4	DTR-	RXD-	N.C
5	GND	GND	GND
6	DSR-	N.C	N.C
7	RTS-	N.C	N.C
8	CTS-	N.C	N.C
9	RI-	N.C	N.C
10	N.C	N.C	N.C

COM2 RS232/RS422/RS485 (TSJ2)

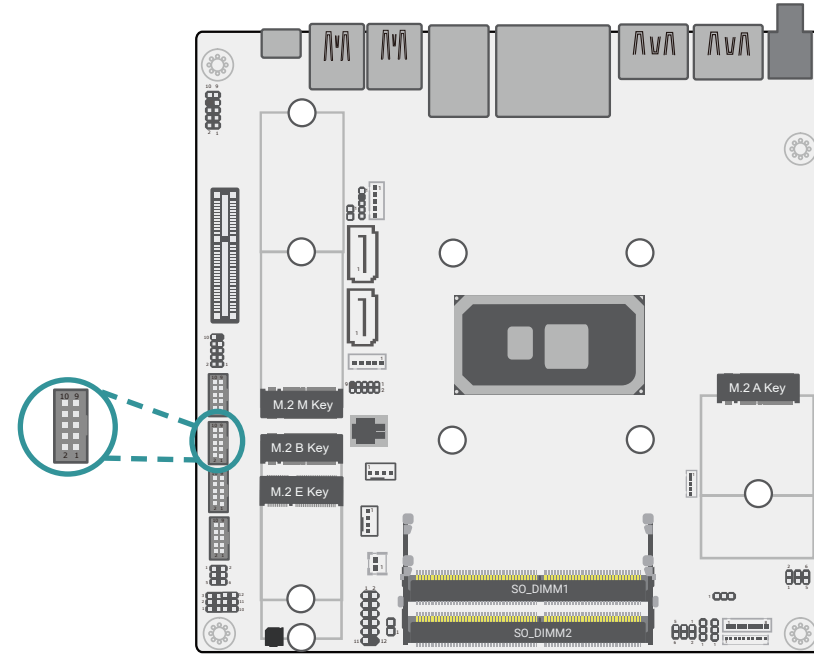

Pin	RS232	RS422 Full Duplex	RS485
1	DCD-	TXD-	Data-
2	RD	TXD+	Data+
3	TD	RXD+	N.C
4	DTR-	RXD-	N.C
5	GND	GND	GND
6	DSR-	N.C	N.C
7	RTS-	N.C	N.C
8	CTS-	N.C	N.C
9	RI-	N.C	N.C
10	N.C	N.C	N.C

COM3 RS232 (J5)

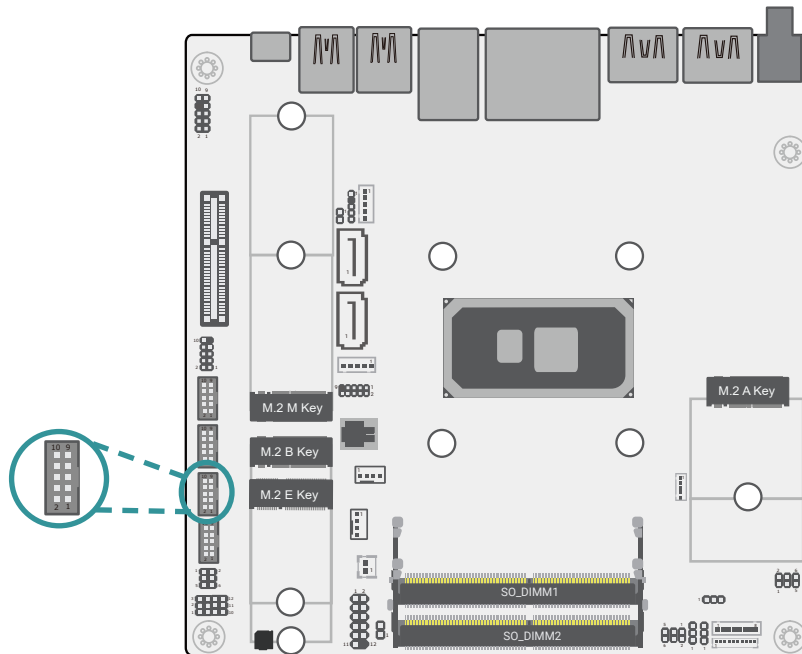

Pin	Assignment	Pin	Assignment
1	MDCD-	2	MSIN-
3	MSO-	4	MDTR-
5	GND	6	MDSR-
7	MRTS-	8	MCTS-
9	MRI-	10	NC

COM4 RS232 (J6)

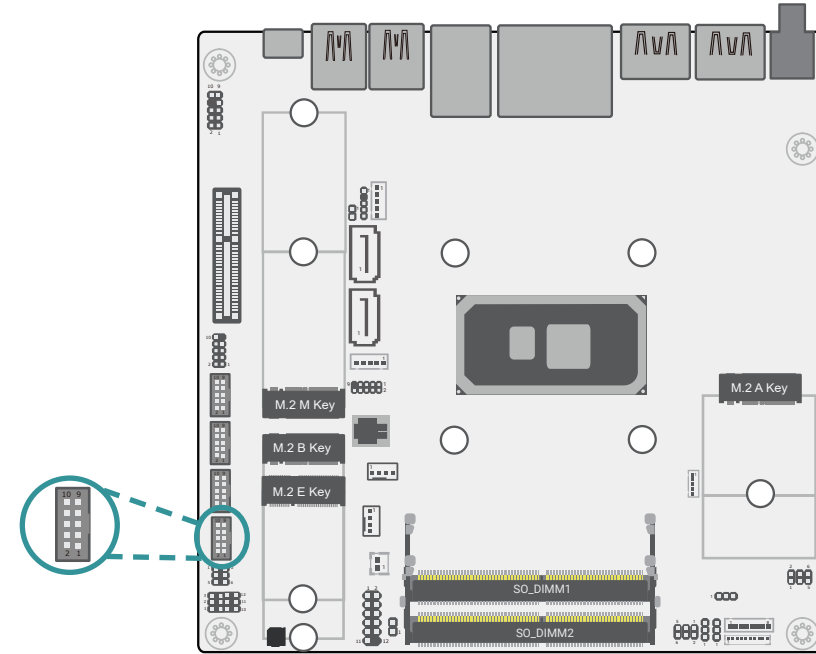

Pin	Assignment	Pin	Assignment
1	MDCD-	2	MSIN-
3	MSO-	4	MDTR-
5	GND	6	MDSR-
7	MRTS-	8	MCTS-
9	MRI-	10	NC



Front Panel (J17)

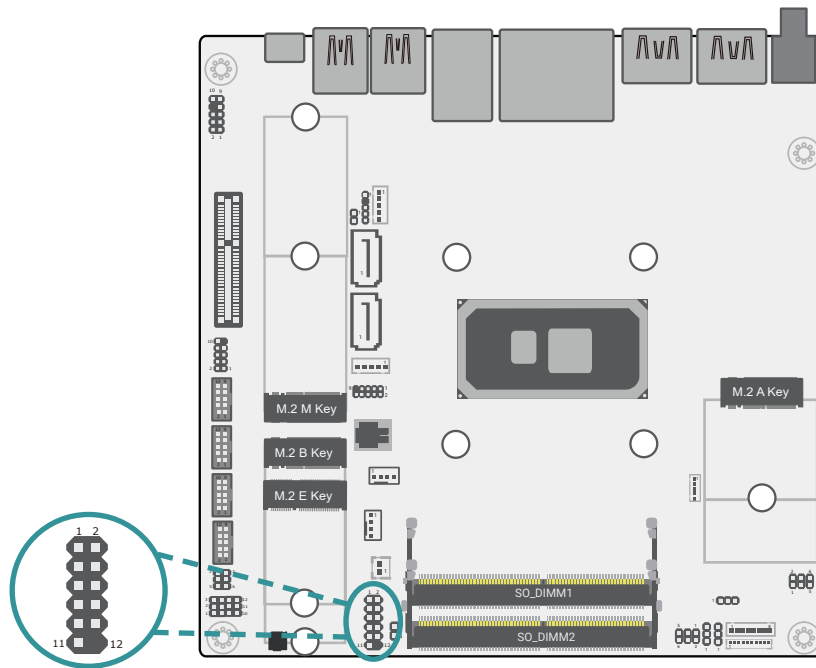

Pin	Assignment	Pin	Assignment
1	NC	2	3V3SB
3	3V3	4	3V3SB
5	HD_LED#	6	SUS_LED#
7	GND	8	GND
9	SYS_RST0	10	PWR_BTN0
11	NC	12	---

COM4 DIO & COM4 Select (JP1)

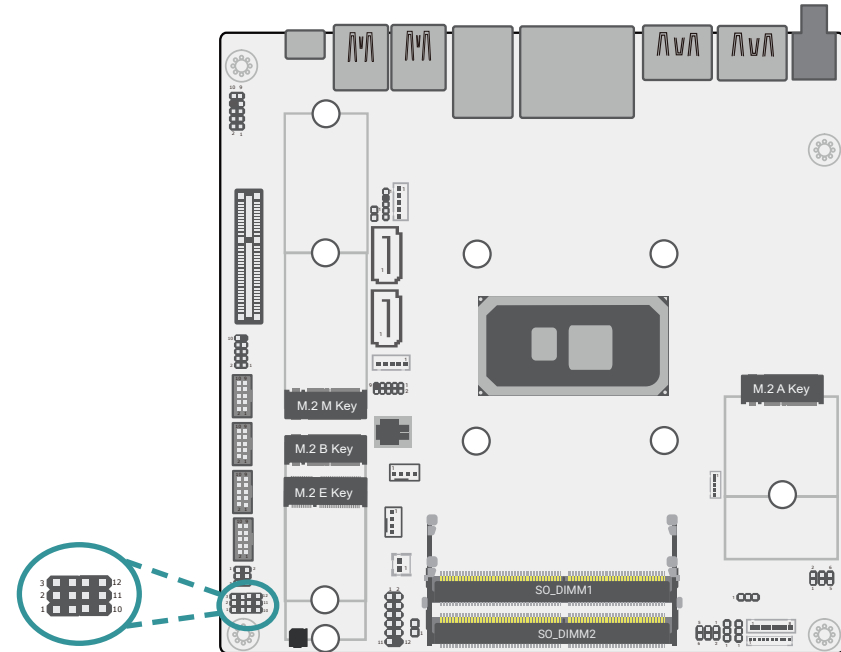

Pin	Assignment	Pin	Assignment
1	MDCD4#	2	X_MDCD4#
3	SIO_DIO0	4	MSIN4#
5	X_MSIN4#	6	SIO_DIO1
7	MSO4#	8	X_MSO4#
9	SIO_DIO2	10	MDTR4#
11	X_MDTR4#	12	SIO_DIO3

► Expansion Slots

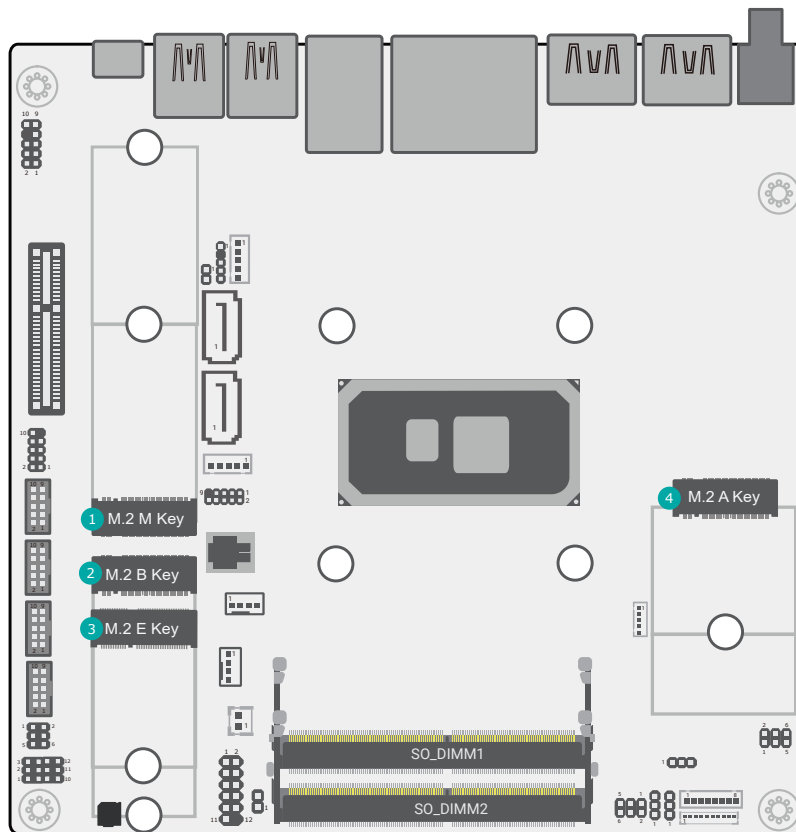

- 1 M.2 M-Key
- 2 M.2 B-Key
- 3 M.2 E-Key
- 4 M.2 A-Key

Installing the M.2 Module

Before installing the M.2 module into the M.2 socket, please make sure that the following safety cautions are well-attended.

1. Make sure the PC and all other peripheral devices connected to it has been powered down.
2. Disconnect all power cords and cables.
3. Locate the M.2 socket on the system board
4. Make sure the notch on card is aligned to the key on the socket.
5. Make sure the standoff screw is removed from the standoff.

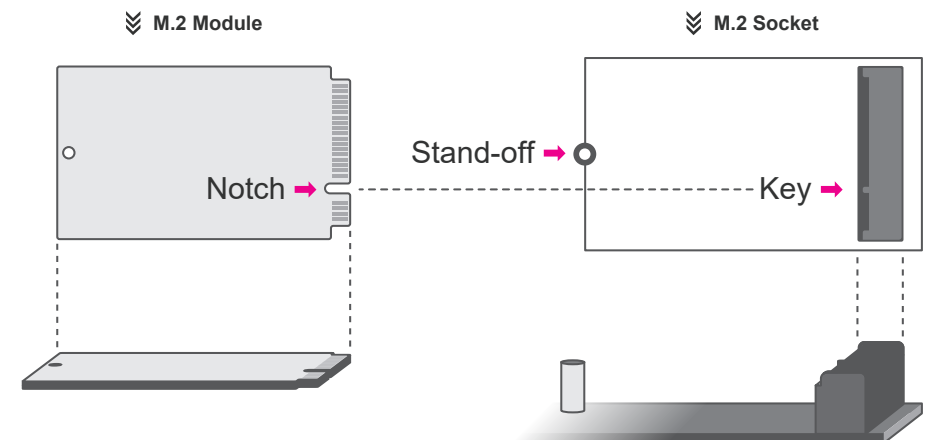

Please follow the steps below to install the card into the socket.

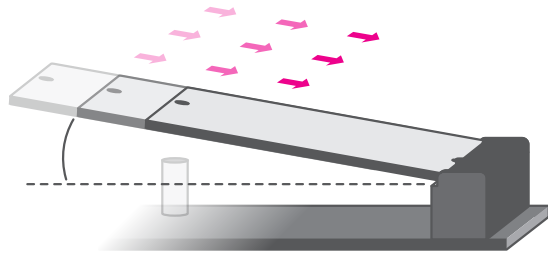

**Step 1:**  
Insert the card into the socket at an angle while making sure the notch and key are perfectly aligned.

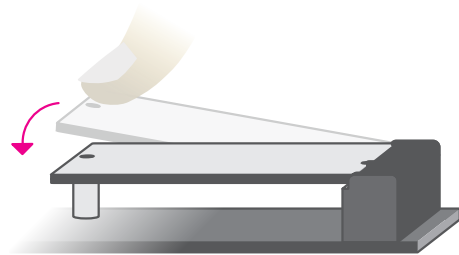

**Step 2:**  
Press the end of the card far from the socket down until against the stand-off.

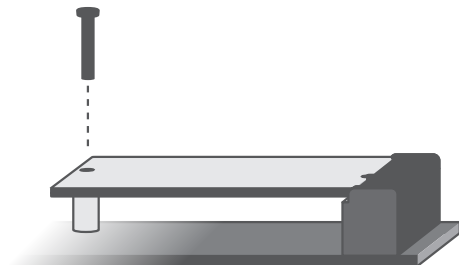

**Step 3:**  
Screw tight the card onto the stand-off with a screw driver and a stand-off screw until the gap between the card and the stand-off closes up. The card should be lying parallel to the board when it's correctly mounted.

## Chapter 3 - BIOS Settings

### ► Overview

The BIOS is a program that takes care of the basic level of communication between the CPU and peripherals. It contains codes for various advanced features found in this system board.

The BIOS allows you to configure the system and save the configuration in a battery-backed CMOS so that the data retains even when the power is off. In general, the information stored in the CMOS RAM of the EEPROM will stay unchanged unless a configuration change has been made such as a hard drive replaced or a device added.

It is possible that the CMOS battery will fail causing CMOS data loss. If this happens, you need to install a new CMOS battery and reconfigure the BIOS settings.



**Note:**

The BIOS is constantly updated to improve the performance of the system board; therefore the BIOS screens in this chapter may not appear the same as the actual one. These screens are for reference purpose only.

### Default Configuration

Most of the configuration settings are either predefined according to the Load Optimal Defaults settings which are stored in the BIOS or are automatically detected and configured without requiring any actions. There are a few settings that you may need to change depending on your system configuration.

### Entering the BIOS Setup Utility

The BIOS Setup Utility can only be operated from the keyboard and all commands are keyboard commands. The commands are available at the right side of each setup screen.

The BIOS Setup Utility does not require an operating system to run. After you power up the system, the BIOS message appears on the screen and the memory count begins. After the memory test, the message "Press DEL to run setup" will appear on the screen. If the message disappears before you respond, restart the system or press the "Reset" button. You may also restart the system by pressing the <Ctrl> <Alt> and <Del> keys simultaneously.

### Legends

Keys	Function
Right / Left arrow	Move the highlight left or right to select a menu
Up / Down arrow	Move the highlight up or down between submenus or fields
<Enter>	Enter the highlighted submenu
+ (plus key)/F6	Scroll forward through the values or options of the highlighted field
- (minus key)/F5	Scroll backward through the values or options of the highlighted field
<F1>	Display general help
<F2>	Display previous values
<F9>	Optimized defaults
<F10>	Save and Exit
<Esc>	Return to previous menu

### Scroll Bar

When a scroll bar appears to the right of the setup screen, it indicates that there are more available fields not shown on the screen. Use the up and down arrow keys to scroll through all the available fields.

### Submenu

When "►" appears on the left of a particular field, it indicates that a submenu which contains additional options are available for that field. To display the submenu, move the highlight to that field and press <Enter>.

► Main

The Main menu is the first screen that you will see when you enter the BIOS Setup Utility.

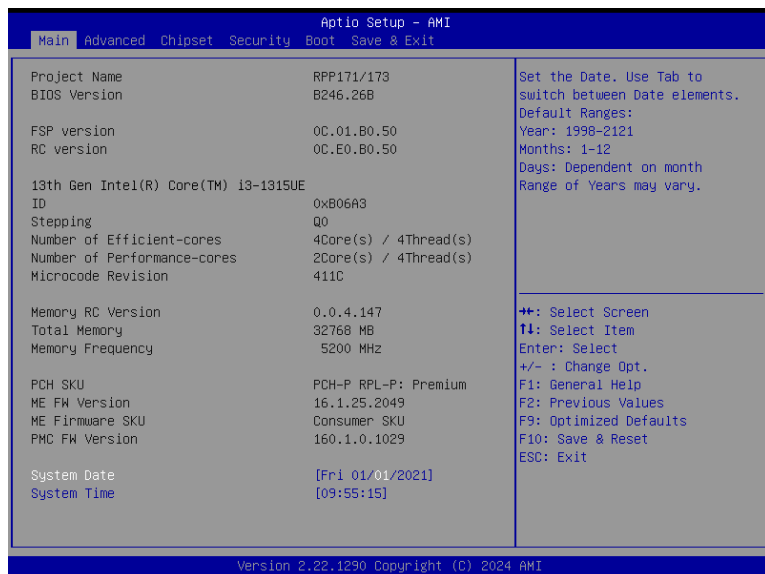

**System Date**

The date format is <month>, <date>, <year>. Press "Tab" to switch to the next field and press "-" or "+" to modify the value.

**System Time**

The time format is <hour>, <minute>, <second>. The time is based on the 24-hour military-time clock. For example, 1 p.m. is 13:00:00. Hour displays hours from 00 to 23. Minute displays minutes from 00 to 59. Second displays seconds from 00 to 59.

► Advanced

The Advanced menu allows you to configure your system for basic operation. Some entries are defaults required by the system board, while others, if enabled, will improve the performance of your system or let you set some features according to your preference.

 **Important:**  
Setting incorrect field values may cause the system to malfunction.

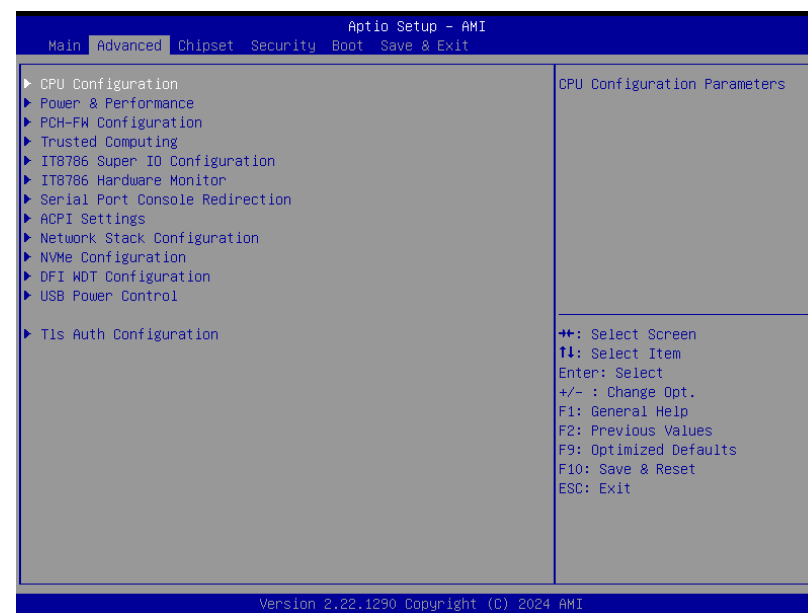

▶ Advanced

CPU Configuration

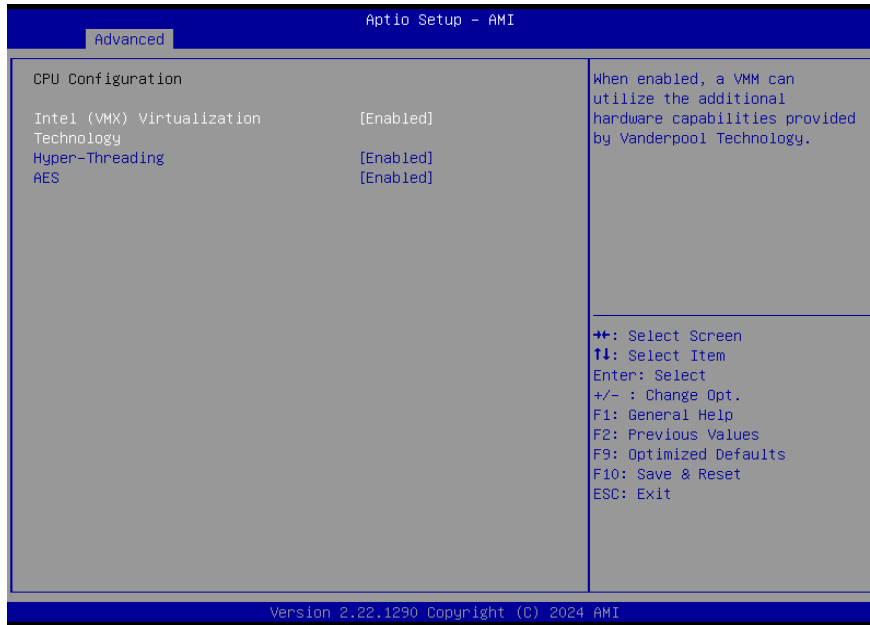

**Intel (VMX) Virtualization Technology**

When this field is set to Enabled, the VMM can utilize the additional hardware capabilities provided by Vanderpool Technology.

**Hyper-threading**

Enables this field for Windows XP and Linux which are optimized for Hyper-Threading technology. Select disabled for other OSes not optimized for Hyper-Threading technology. When disabled, only one thread per enabled core is enabled.

**AES**

Enable / Disable AES (Advanced Encryption Standard)

▶ Advanced

Power & Performance

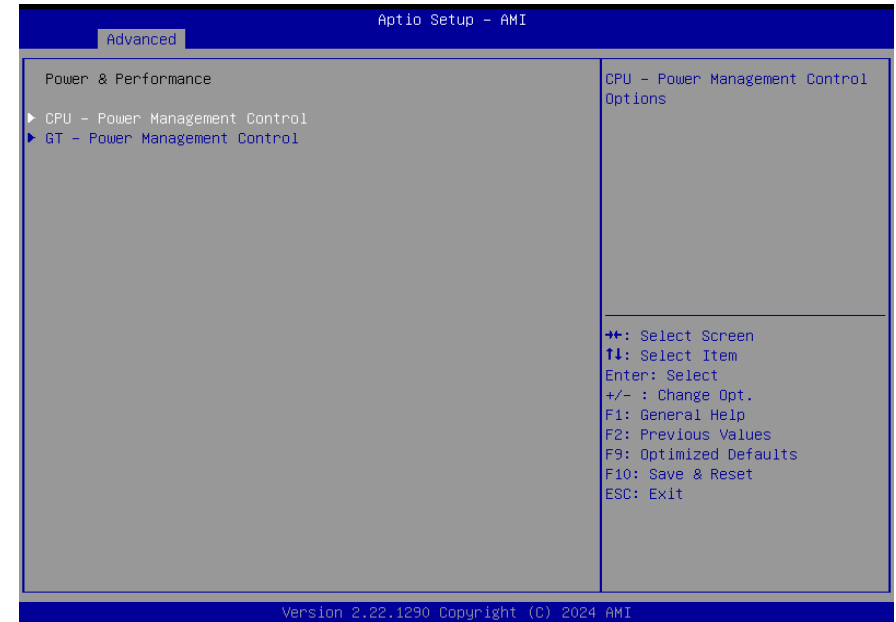

▶ Advanced

Power & Performance ▶ CPU- Power Management Control

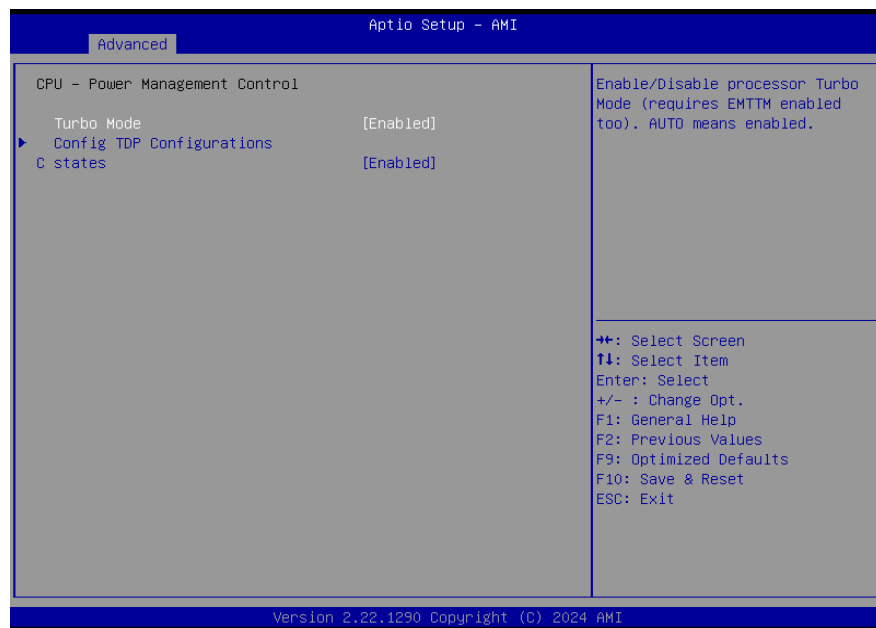

**Turbo Mode**

Enable/Disable processor Turbo Mode (requires EMTTM enabled too). AUTO means enabled.

**C states**

Enable or disable CPU Power Management. It allows CPU to enter "C states" when it's idle and nothing is executing.

▶ Advanced

Power & Performance ▶ GT- Power Management Control



**RC6 (Render Standby)**

Check to enable render standby support.

▶ Advanced

PCH-FW Configuration

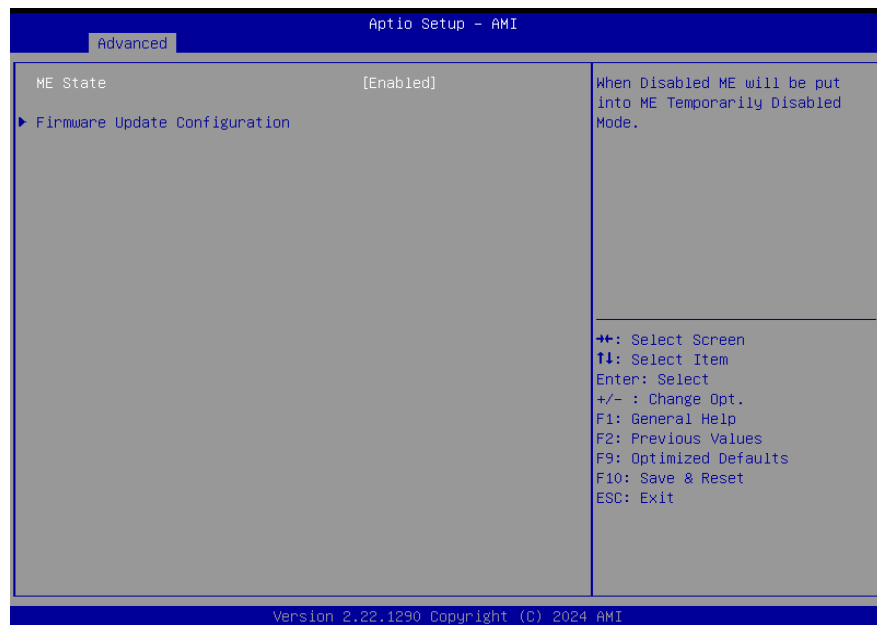

**ME State**

When this field is set to Disabled, ME will be put into ME Temporarily Disabled Mode.

**Firmware Update Configuration**

Configure Management Engine Technology Parameters.



**Note:**  
The sub-menus are detailed in following sections.

▶ Advanced

Trusted Computing



**Security Device Support**

This field is used to enable or disable BIOS support for the security device such as an TPM 2.0 to achieve hardware-level security via cryptographic keys.

**Pending operation**

To clear the existing TPM encryption, select "TPM Clear" and restart the system. This field is not available when "Security Device Support" is disabled.



▶ Advanced

IT8786 Super IO Configuration

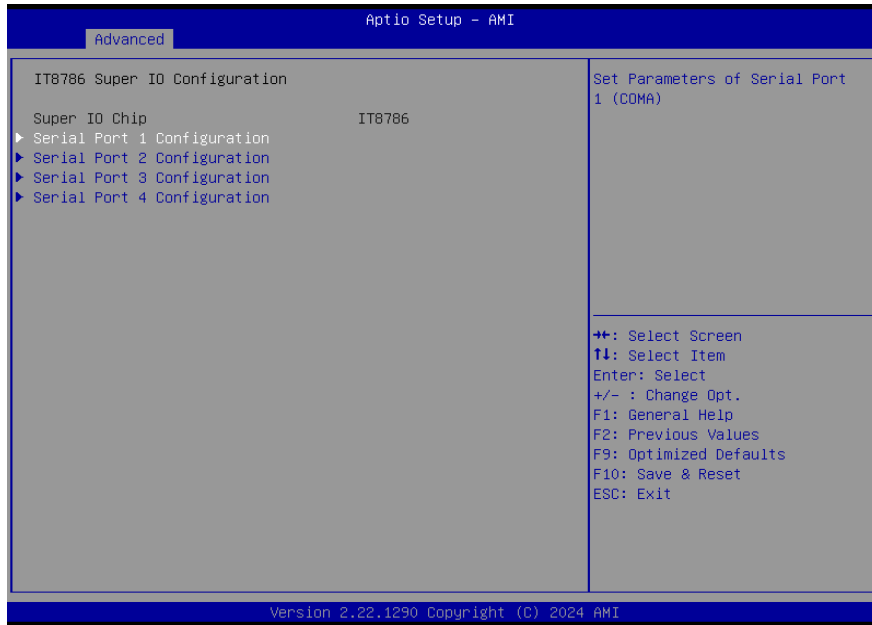

▶ Advanced

IT8786 Super IO Configuration ▶ Serial Port 1, 2 Configuration



**Serial Port**

Enable or disable serial port.

▶ Advanced

IT8786 Super IO Configuration ▶ Serial Port 3, 4 Configuration

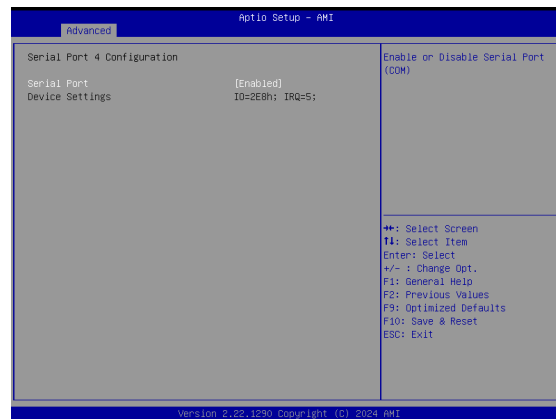
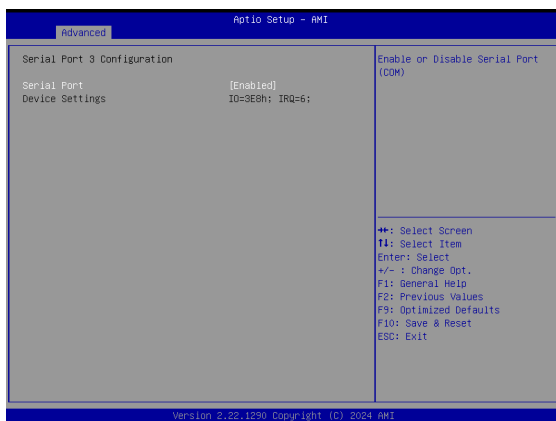

**Serial Port**

Enable or disable serial port.

▶ Advanced

IT8786 HW Monitor

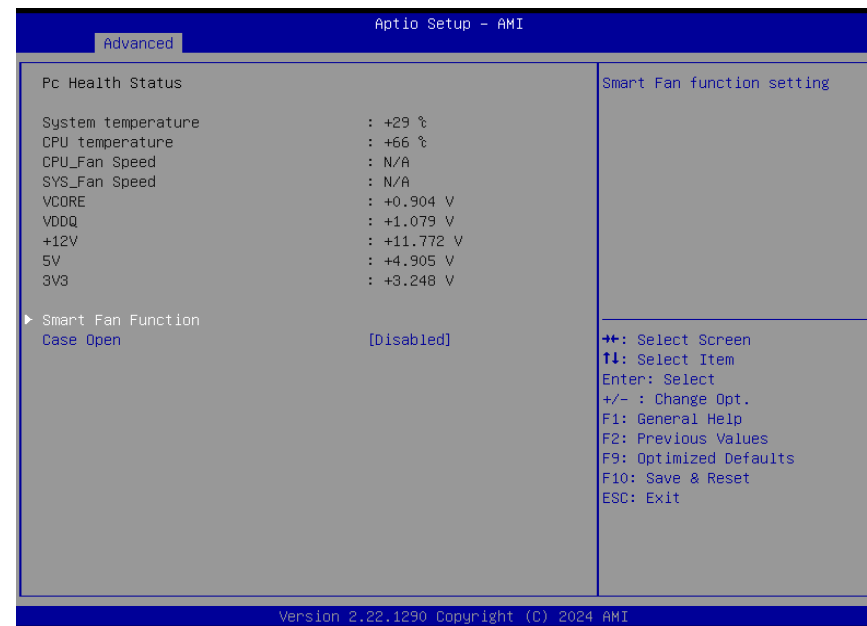

This section displays the system's health information, i.e. voltage readings, CPU and system temperatures, and fan speed readings

**Smart Fan Function**

Smart Fan Function Setting.

**Case Open**

Enable or disable the case open detection function.

▶ Advanced

IT8786 HW Monitor ▶ Smart FAN Function

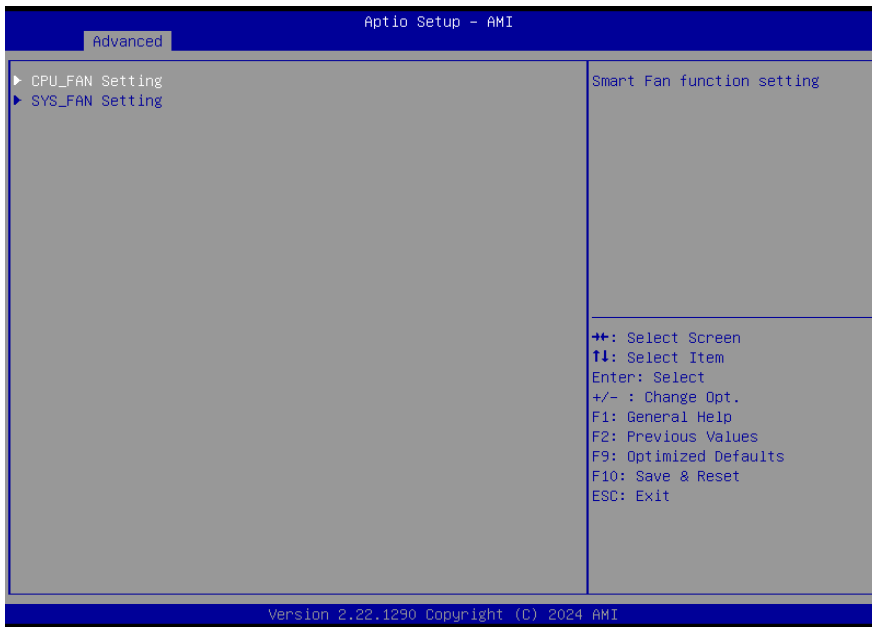

▶ Advanced

IT8786 HW Monitor ▶ Smart FAN Function ▶ CPU\_FAN Setting

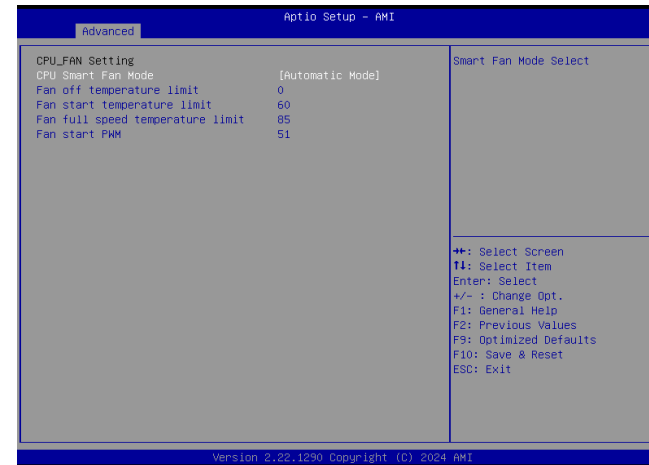

IT8786 HW Monitor ▶ Smart FAN Function ▶ SYS\_FAN Setting

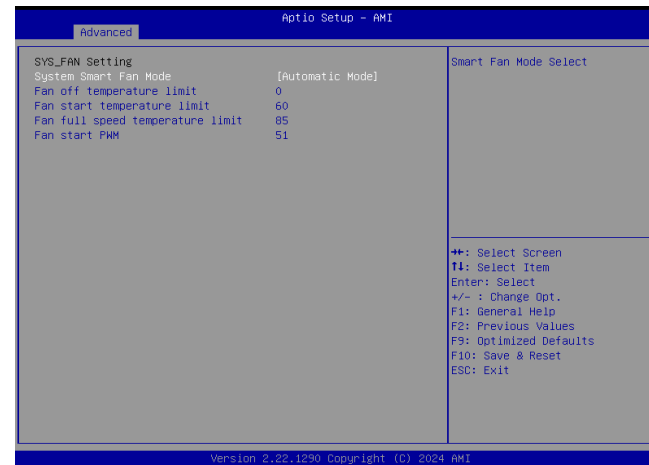

### CPU / System Smart Fan Mode

Smart Fan Mode Select

#### Fan off temperature limit

Fan will be turned off when the temperature is lower than this limit.

#### Fan start temperature limit

Fan will start working when the temperature is higher than this limit.

#### Fan full speed temperature limit

Fan will be full speed when the temperature is higher than this limit.

#### Fan start PWM

Fan will start with this PWM value.

### ► Advanced

## Serial Port Console Redirection

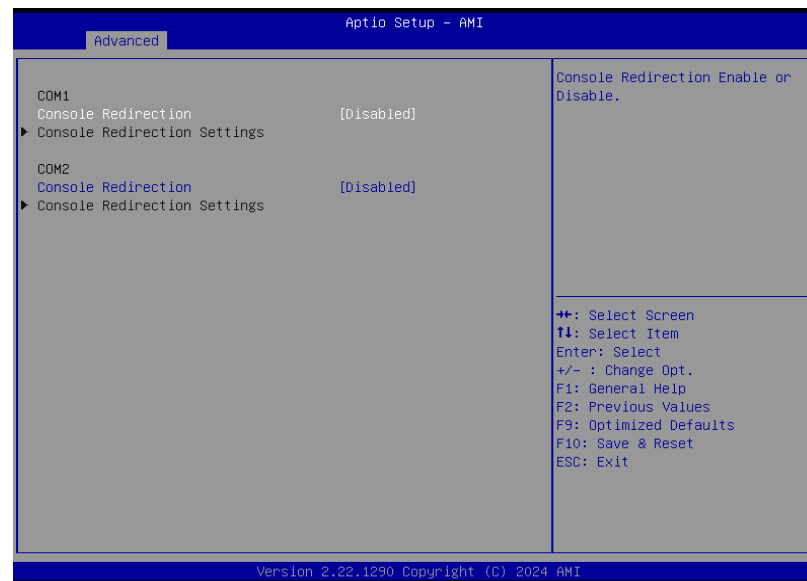

### Console Redirection

By enabling Console Redirection of a COM port, the sub-menu of console redirection settings will become available for configuration as detailed in the following.

► Advanced

Serial Port Console Redirection ► Console Redirection Settings

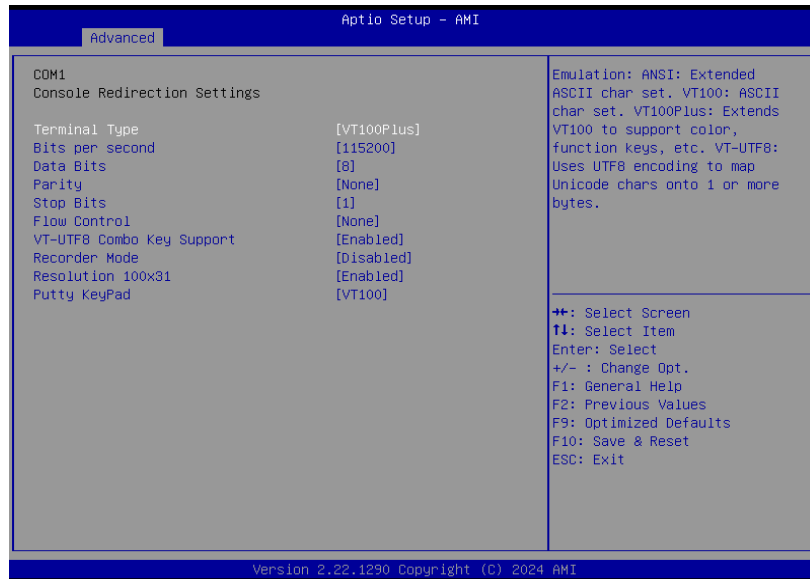

Configure the serial settings of the current COM port.

**Terminal Type**

Select terminal type: VT100, VT100+, VT-UTF8 or ANSI.

**Bits per second**

Select serial port transmission speed: 9600, 19200, 38400, 57600 or 115200.

**Data Bits**

Select data bits: 7 bits or 8 bits.

**Parity**

Select parity bits: None, Even, Odd, Mark or Space.

**Stop Bits**

Select stop bits: 1 bit or 2 bits.

**Flow Control**

Select flow control type: None or Hardware RTS/CTS. Flow Control is for RS485 mode and is only supported by Serial Port 1 (COM1).

**VT-UTF8 Combo Key Support**

Enable VT-UTF8 Combination Key Support for ANSI/VT100 terminals.

**Recorder Mode**

With this mode enabled only text will be sent. This is to capture Terminal data.

**Resolution 100x31**

Enables or disables extended terminal resolution

**Putty KeyPad**

Select FunctionKey and KeyPad on Putty.

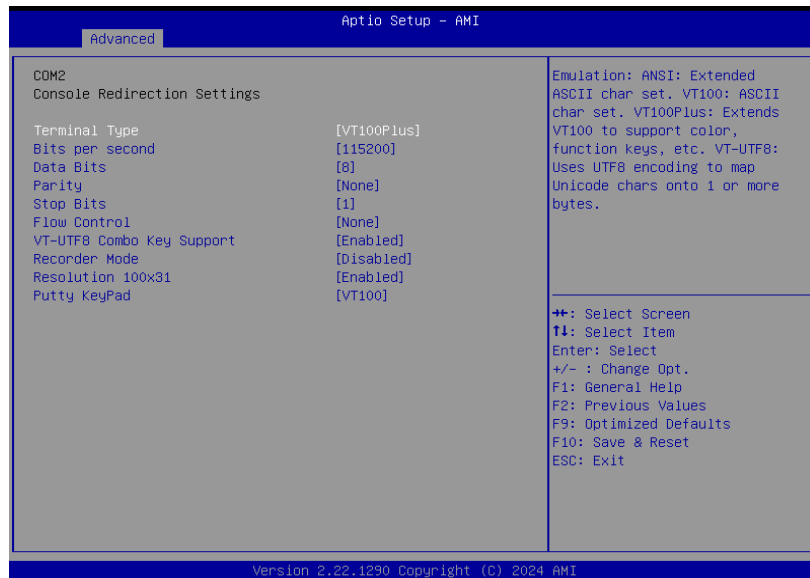

▶ Advanced

## ACPI Settings

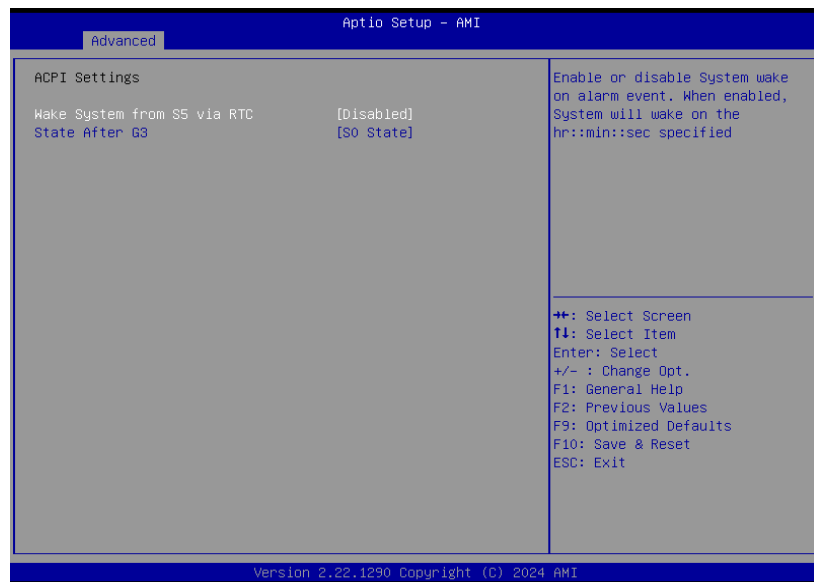

### Wake system from S5 via RTC

When Enabled, the system will automatically power up at a designated time every day. Once it's switched to [Enabled], please set up the time of day – hour, minute, and second – for the system to wake up.

### State After G3

Select between S0 State, and S5 State. This field is used to specify what state the system is set to return to when power is re-applied after a power failure (G3 state).

- **S0 State** The system automatically powers on after power failure.
- **S5 State** The system enter soft-off state after power failure. Power-on signal input is required to power up the system.

▶ Advanced

## Network Stack Configuration

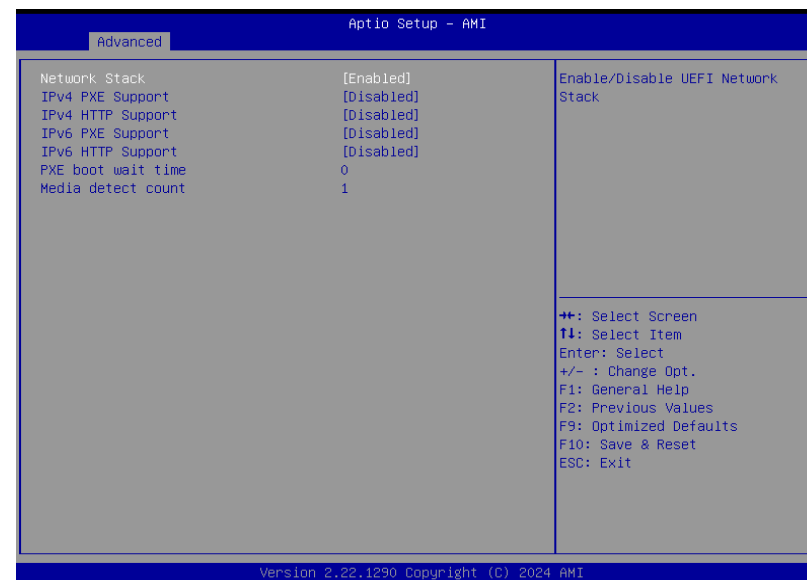

### Network Stack

Enable or disable UEFI network stack. The following fields will appear when this field is enabled.

### Ipv4 PXE Support

Enable or disable IPv4 PXE boot support. If disabled, IPv4 PXE boot support will not be available.

### Ipv4 HTTP Support

Enable or disable IPv4 HTTP boot support. If disabled, IPv4 HTTP boot support will not be available.

### Ipv6 PXE Support

Enable or disable IPv6 PXE boot support. If disabled, IPv6 PXE boot support will not be available.

### Ipv6 HTTP Support

Enable or disable IPv6 HTTP boot support. If disabled, IPv6 HTTP boot support will not be available.

### PXE boot wait time

Set the wait time in seconds to press ESC key to abort the PXE boot. Use either +/- or numeric keys to set the value.

### Media detect count

Set the number of times the presence of media will be checked. Use either +/- or numeric keys to set the value.

### ▶ Advanced

### DFI WDT Configuration



### Watchdog Timer

Enable or disable Watchdog Timer.

▶ Advanced

USB Power Control

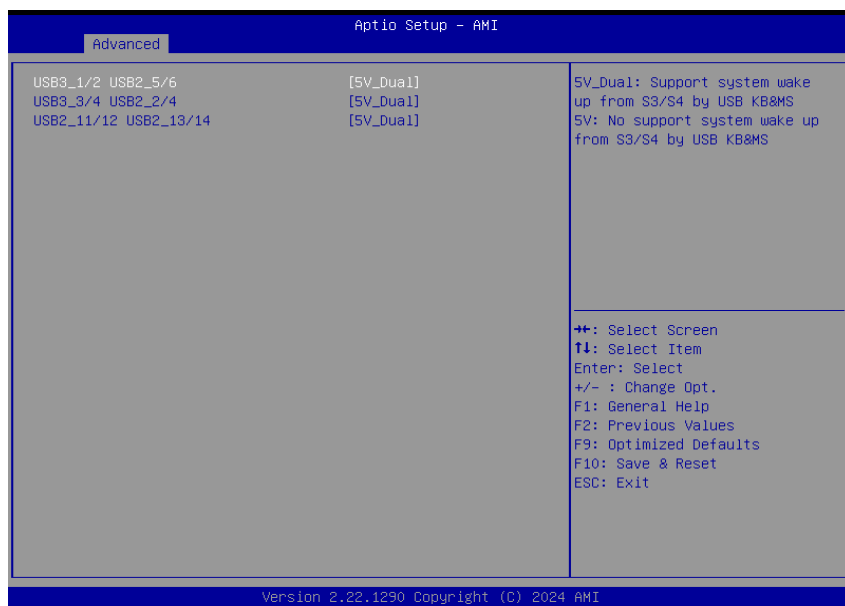

**Server CA Configuration**

**5\_Dual:** Support system wake up from S3/S4 by USB KB&MS

**5V:** No support system wake up from S3/S4 by USB KB&MS

▶ Advanced

Tls Auth Configuration



**Server CA Configuration**

Press <Enter> to configure Server CA.



► Chipset

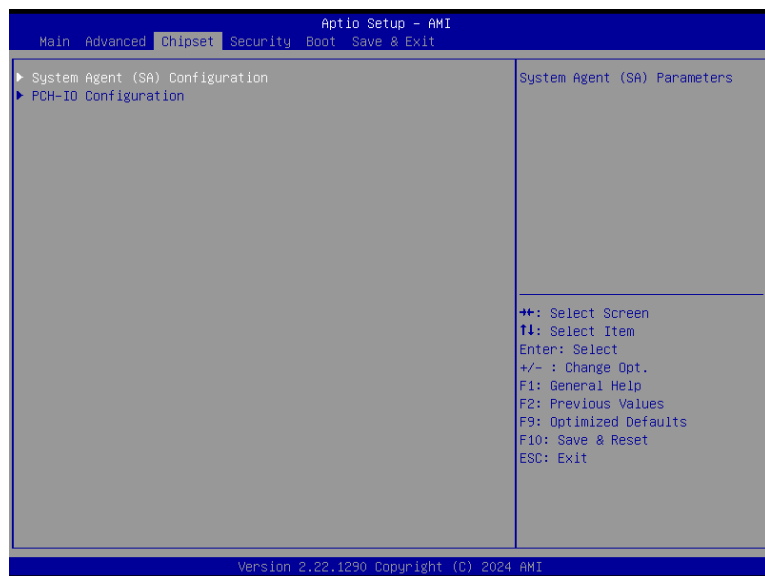

Please select a submenu and press Enter. The submenus are detailed in the following pages.

► Chipset

System Agent (SA) Configuration



**Graphics Configuration**

Settings about graphic.

**VMD setup menu**

VMD Configuration Settings

**PCI Express Configuration :**

**VT-d**

VT-d capability.

▶ Chipset

PCH-IO Configuration



**PCI Express Configuration**

PCI Express Configuration Settings

**SATA Configuration**

SATA Device Options Settings

**HD Audio Configuration**

HD Audio Subsystem Configuration Settings

▶ Chipset

PCH-IO Configuration ▶ PCI Express Configuration

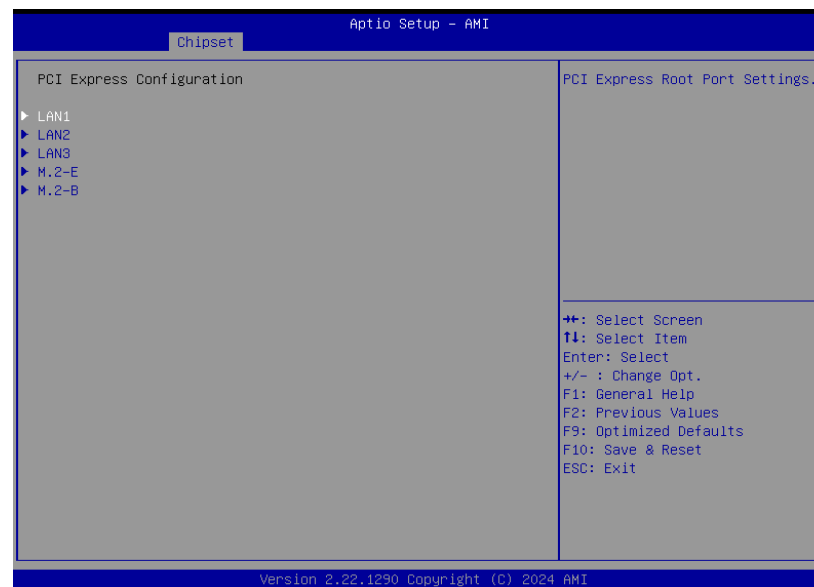

Select one of the PCI Express channels and press enter to configure the following settings.

**LAN1, LAN2, LAN3, M.2-E, M.2-B**

Control the PCI Express Root Port.

► Chipset

PCH-IO Configuration ► SATA Configuration

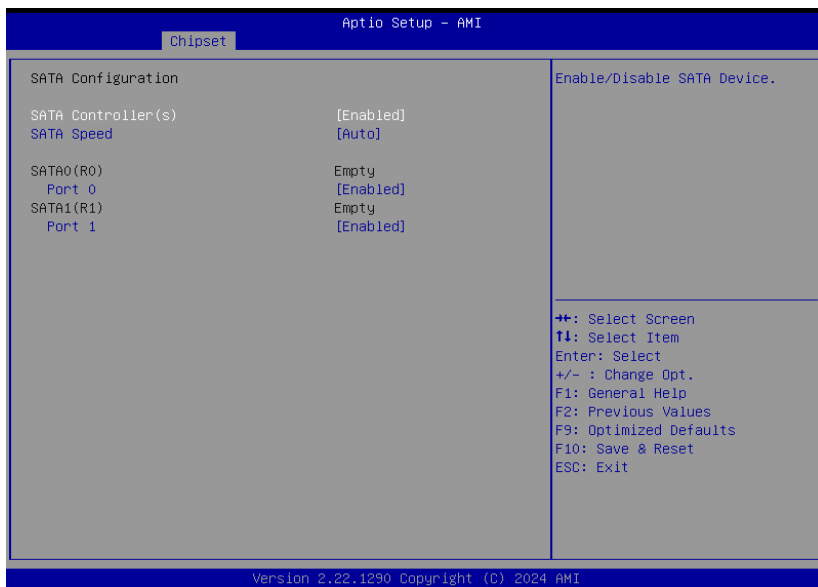

**SATA Controller(s)**

This field is used to enable or disable the Serial ATA controller.

**SATA Speed**

This field is used to select SATA speed generation limit: Auto, Gen1, Gen2 or Gen3.

**Ports**

Enable or disable the Serial ATA port function.

► Chipset

PCH-IO Configuration ► HD Audio Configuration

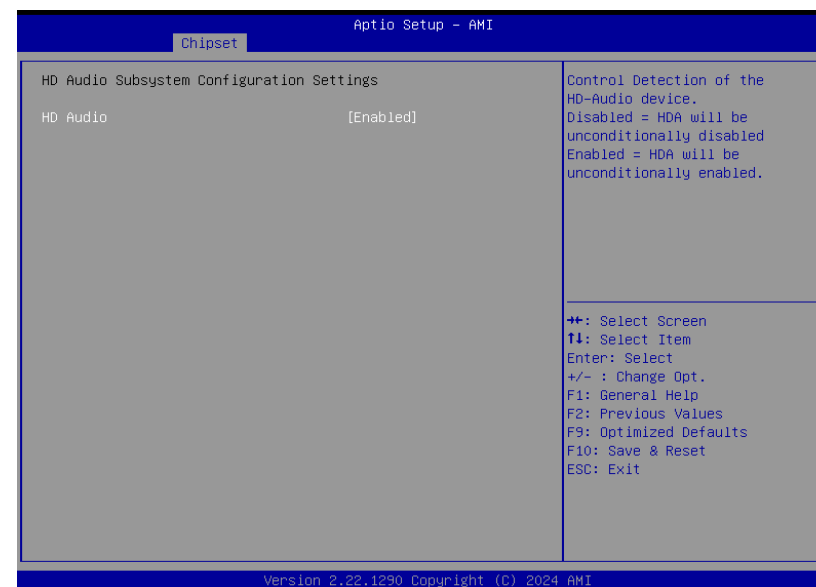

**HD Audio**

Control the detection of the HD Audio device.

- **Disabled** HDA will be unconditionally disabled.
- **Enabled** HDA will be unconditionally enabled.

► Security

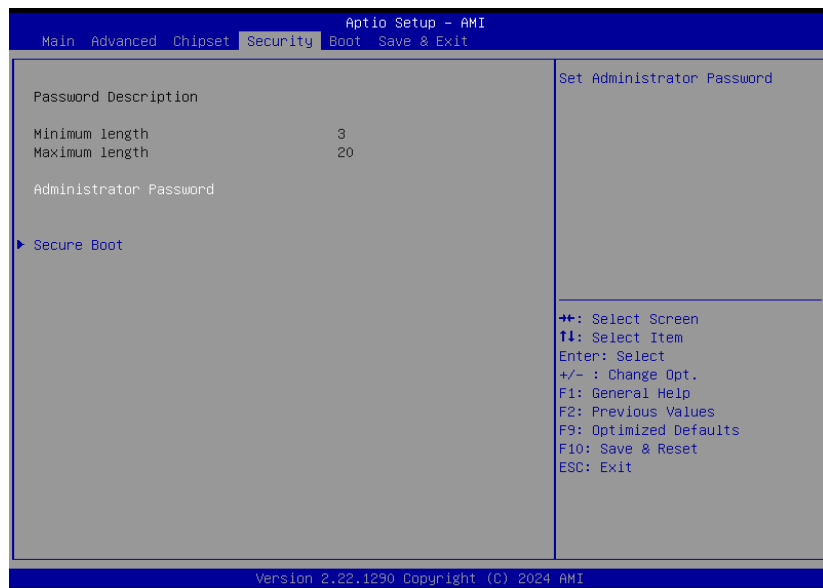

**Administrator Password**

Set the administrator password. To clear the password, input nothing and press enter when a new password is asked. Administrator Password will be required when entering the BIOS.

**User Password**

Set the user password. To clear the password, input nothing and press enter when a new password is asked. User Password will be required when powering up the system.

► Security

Secure Boot



**Secure Boot**

The Secure Boot store a database of certificates in the firmware and only allows the OSEs with authorized signatures to boot on the system. To activate Secure Boot, please make sure that "Secure Boot" is "[Enabled]", Platform Key (PK) is enrolled, "System Mode" is "User", and CSM is disabled. After enabling/disabling Secure Boot, please save the configuration and restart the system. When configured and activated correctly, the Secure Boot status will be "Active".

**Secure Boot Mode**

Select the secure boot mode – Standard or Custom. When set to Custom, the following fields will be configurable for the user to manually modify the key database.

**Restore Factory Keys**

Force system to User Mode. Load OEM-defined factory defaults of keys and databases onto the Secure Boot. Press Enter and a prompt will show up for you to confirm.

**Reset To Setup Mode**

Clear the database from the NVRAM, including all the keys and signatures installed in the Key Management menu. Press Enter and a prompt will show up for you to confirm.

**Key Management**

Enables expert users to modify Secure Boot Policy variables without full authentication.

► Boot



**Setup Prompt Timeout**

Set the number of seconds to wait for the setup activation key. 65535 (0xFFFF) denotes indefinite waiting.

**Bootup NumLock State**

Select the keyboard NumLock state: On or Off.

**Quiet Boot**

This section is used to enable or disable quiet boot option.

**Boot Option Priorities**

Rearrange the system boot order of available boot devices.



**Note:**

If “Boot option filter” of “CSM Configuration” is set to “UEFI and Legacy” or “UEFI only”, and “Quiet Boot” is set to enabled, “BGRT Logo” will show up for configuration. Refer to the Advanced > CSM Configuration submenu for more information.

► Save & Exit

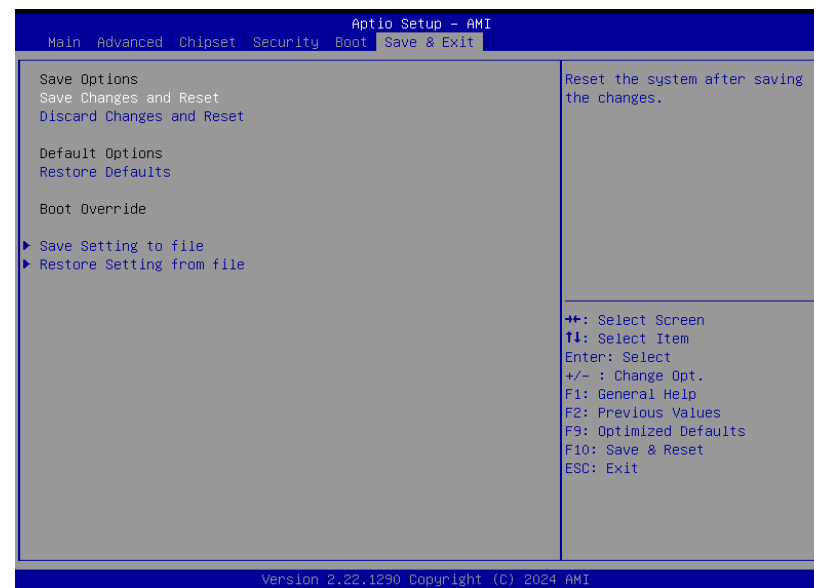

**Save Changes and Reset**

To save the changes, select this field and then press <Enter>. A dialog box will appear. Select Yes to reset the system after saving all changes made.

**Discard Changes and Reset**

To discard the changes, select this field and then press <Enter>. A dialog box will appear. Select Yes to reset the system setup without saving any changes.

**Restore Defaults**

To restore and load the optimized default values, select this field and then press <Enter>. A dialog box will appear. Select Yes to restore the default values of all the setup options.

**Boot Override**

Move the cursor to an available boot device and press Enter, and then the system will immediately boot from the selected boot device. The Boot Override function will only be effective for the current boot. The “Boot Option Priorities” configured in the Boot menu will not be changed.

- **Save Setting to file** Select this option to save BIOS configuration settings to a USB flash device.
- **Restore Setting from file** This field will appear only when a USB flash device is detected. Select this field to restore setting from the USB flash device.

## ► Updating the BIOS

---

To update the BIOS, you will need the new BIOS file and a flash utility. Please contact technical support or your sales representative for the files and specific instructions about how to update BIOS with the flash utility.

## ► Notice: BIOS SPI ROM

---

1. The Intel® Management Engine has already been integrated into this system board. Due to the safety concerns, the BIOS (SPI ROM) chip cannot be removed from this system board and used on another system board of the same model.
2. The BIOS (SPI ROM) on this system board must be the original equipment from the factory and cannot be used to replace one which has been utilized on other system boards.
3. If you do not follow the methods above, the Intel® Management Engine will not be updated and will cease to be effective.



**Note:**

- a. You can take advantage of flash tools to update the default configuration of the BIOS (SPI ROM) to the latest version anytime.
- b. When the BIOS IC needs to be replaced, you have to populate it properly onto the system board after the EEPROM programmer has been burned and follow the technical person's instructions to confirm that the MAC address should be burned or not.
- c. After updating unique MAC Address from manufacturing, NVM will be protected immediately after power cycle. Users cannot update NVM or MAC address.