

HM101-QM87/HM86

Mini-ITX Industrial Motherboard

User's Manual

Copyright

This publication contains information that is protected by copyright. No part of it may be reproduced in any form or by any means or used to make any transformation/adaptation without the prior written permission from the copyright holders.

This publication is provided for informational purposes only. The manufacturer makes no representations or warranties with respect to the contents or use of this manual and specifically disclaims any express or implied warranties of merchantability or fitness for any particular purpose. The user will assume the entire risk of the use or the results of the use of this document. Further, the manufacturer reserves the right to revise this publication and make changes to its contents at any time, without obligation to notify any person or entity of such revisions or changes.

Changes after the publication's first release will be based on the product's revision. The website will always provide the most updated information.

© 2015. All Rights Reserved.

Trademarks

Product names or trademarks appearing in this manual are for identification purpose only and are the properties of the respective owners.

FCC and DOC Statement on Class B

This equipment has been tested and found to comply with the limits for a Class B digital device, pursuant to Part 15 of the FCC rules. These limits are designed to provide reasonable protection against harmful interference when the equipment is operated in a residential installation. This equipment generates, uses and can radiate radio frequency energy and, if not installed and used in accordance with the instruction manual, may cause harmful interference to radio communications. However, there is no guarantee that interference will not occur in a particular installation. If this equipment does cause harmful interference to radio or television reception, which can be determined by turning the equipment off and on, the user is encouraged to try to correct the interference by one or more of the following measures:

- Reorient or relocate the receiving antenna.
- Increase the separation between the equipment and the receiver.
- Connect the equipment into an outlet on a circuit different from that to which the receiver is connected.
- Consult the dealer or an experienced radio TV technician for help.

Notice:

1. The changes or modifications not expressly approved by the party responsible for compliance could void the user's authority to operate the equipment.
2. Shielded interface cables must be used in order to comply with the emission limits.

Table of Contents

Copyright.....	2	Digital I/O Connector	22
Trademarks	2	Digital I/O Power Connector.....	22
FCC and DOC Statement on Class B.....	2	Front Panel Connector	23
About this Manual	4	Chassis Intrusion Connector	23
Warranty	4	LVDS LCD Panel Connector	24
Static Electricity Precautions.....	4	LCD/Inverter Power Connector	24
Safety Measures	4	DisplayPort Connector.....	25
About the Package.....	5	Expansion Slots	25
Chapter 1 - Introduction	6	S/PDIF Connector.....	26
Specifications	6	Standby Power LED	26
Features.....	7	Battery.....	27
Chapter 2 - Hardware Installation.....	9	Chapter 3 - BIOS Setup.....	28
Board Layout.....	9	Overview	28
System Memory.....	9	AMI BIOS Setup Utility.....	29
Installing the DIMM Module	10	Main	29
Installing the Fan and Heat Sink	11	Advanced	29
Jumper Settings	12	Chipset	39
Clear CMOS Data.....	12	Boot.....	47
USB Power Select	13	Security.....	48
Power-on Select.....	13	Save & Exit.....	49
Mini PCIe Signal Select	14	Updating the BIOS	49
SATA DOM Power Select	14	Notice: BIOS SPI ROM	50
Panel Power Select	15	Chapter 4 - Supported Software	51
Backlight Power Select.....	15	Chapter 5 - Digital I/O Programming Guide.....	70
Digital I/O Power Select.....	16	Chapter 6 - RAID (HM101-QM87)	72
Digital I/O Output State.....	16	RAID Levels.....	72
Rear Panel I/O Ports.....	17	Settings	72
12V DC-in	17	Chapter 7 - Intel AMT Settings (HM101-QM87).....	75
COM (Serial) Ports.....	18	Overview	75
Graphics Interfaces.....	18	Enable Intel® AMT in the AMI BIOS.....	75
RJ45 LAN Ports.....	19	Enable Intel® AMT in the Intel® Management Engine BIOS	
USB Ports.....	19	Extension (MEBX) Screen.....	76
Audio	20	Appendix A - Watchdog Sample Code.....	89
I/O Connectors.....	21	Appendix B - System Error Message.....	90
SATA (Serial ATA) Connectors.....	21	Appendix C - Troubleshooting	91
SATA (Serial ATA) Power Connectors.....	21		
Cooling Fan Connectors.....	22		

About this Manual

This manual can be downloaded from the website, or acquired as an electronic file included in the optional CD/DVD. The manual is subject to change and update without notice, and may be based on editions that do not resemble your actual products. Please visit our website or contact our sales representatives for the latest editions.

Warranty

1. Warranty does not cover damages or failures that arised from misuse of the product, inability to use the product, unauthorized replacement or alteration of components and product specifications.
2. The warranty is void if the product has been subjected to physical abuse, improper installation, modification, accidents or unauthorized repair of the product.
3. Unless otherwise instructed in this user's manual, the user may not, under any circumstances, attempt to perform service, adjustments or repairs on the product, whether in or out of warranty. It must be returned to the purchase point, factory or authorized service agency for all such work.
4. We will not be liable for any indirect, special, incidental or consequential damages to the product that has been modified or altered.

Static Electricity Precautions

It is quite easy to inadvertently damage your PC, system board, components or devices even before installing them in your system unit. Static electrical discharge can damage computer components without causing any signs of physical damage. You must take extra care in handling them to ensure against electrostatic build-up.

1. To prevent electrostatic build-up, leave the system board in its anti-static bag until you are ready to install it.
2. Wear an antistatic wrist strap.
3. Do all preparation work on a static-free surface.
4. Hold the device only by its edges. Be careful not to touch any of the components, contacts or connections.
5. Avoid touching the pins or contacts on all modules and connectors. Hold modules or connectors by their ends.



Important:

Electrostatic discharge (ESD) can damage your processor, disk drive and other components. Perform the upgrade instruction procedures described at an ESD workstation only. If such a station is not available, you can provide some ESD protection by wearing an antistatic wrist strap and attaching it to a metal part of the system chassis. If a wrist strap is unavailable, establish and maintain contact with the system chassis throughout any procedures requiring ESD protection.

Safety Measures

To avoid damage to the system:

- Use the correct AC input voltage range.

To reduce the risk of electric shock:

- Unplug the power cord before removing the system chassis cover for installation or servicing. After installation or servicing, cover the system chassis before plugging the power cord.

About the Package

The package contains the following items. If any of these items are missing or damaged, please contact your dealer or sales representative for assistance.

- One HM101 motherboard
- One Serial ATA data with power cable
- One I/O shield
- One QR (Quick Reference)
- One Heat sink with fan

The board and accessories in the package may not come similar to the information listed above. This may differ in accordance to the sales region or models in which it was sold. For more information about the standard package in your region, please contact your dealer or sales representative.

Optional Items

- USB port cable
- I/O shield
- Serial ATA data cable with power cable
- Power adapter (100W, 12V)
- Power adapter (120W, 19V)
- EXT-DP riser card

The board and accessories in the package may not come similar to the information listed above. This may differ in accordance to the sales region or models in which it was sold. For more information about the standard package in your region, please contact your dealer or sales representative.

Before Using the System Board

Before using the system board, prepare basic system components.

If you are installing the system board in a new system, you will need at least the following internal components.

- Memory module
- Storage devices such as hard disk drive, CD-ROM, etc.

You will also need external system peripherals you intend to use which will normally include at least a keyboard, a mouse and a video display monitor.

Chapter 1 - Introduction

Specifications

Processor	<ul style="list-style-type: none"> 4th generation Intel® Core™ processors <ul style="list-style-type: none"> : Intel® Core™ i7-4700EQ, 6M Cache, up to 3.4 GHz, 47W : Intel® Core™ i5-4400E, 3M Cache, up to 3.3 GHz, 37W : Intel® Core™ i5-4402E, 3M Cache, up to 2.7 GHz, 25W : Intel® Core™ i3-4100E, 3M Cache, 2.4 GHz, 37W : Intel® Core™ i3-4102E, 3M Cache, 1.6 GHz, 25W BGA 1364 packaging technology 22nm process technology
Chipset	<ul style="list-style-type: none"> Intel® QM87 Express Chipset (HM101-QM87) Intel® HM86 Express Chipset (HM101-HM86)
Super I/O Address	<ul style="list-style-type: none"> NCT6102/4Eh
System Memory	<ul style="list-style-type: none"> Two 204-pin DDR3L SODIMM sockets Supports DDR3L 1333/1600MHz Supports dual channel memory interface Supports up to 16GB system memory DRAM device technologies: 1Gb, 2Gb and 4Gb DDR3L DRAM technologies are supported for x8 and x16 devices, unbuffered, non-ECC
Expansion Interfaces	<ul style="list-style-type: none"> 1 PCIe x16 Gen 3 slot (PCIe 3.0) 1 Mini PCIe slot <ul style="list-style-type: none"> - Supports USB and PCIe signals - Supports mSATA - Supports half size Mini PCIe card
Graphics	<ul style="list-style-type: none"> Intel® HD Graphics 4600 Display ports: 1 HDMI, 1 DVI-I, 1 LVDS, 1 DP HDMI: resolution up to 4096x2304 @24Hz or 2560x1600 @60Hz DVI-I: resolution up to 1920x1200 @60Hz LVDS: NXP PTN3460, 24-bit, dual channel, resolution up to 1920x1200 @60Hz DP: resolution up to 3840x2160 @60Hz Intel® Clear Video Technology DirectX Video Acceleration (DXVA) support for accelerating video processing Supports DirectX 11.1, OpenGL 3.2, OpenCL 1.2
Audio	<ul style="list-style-type: none"> Realtek ALC886 5.1-channel High Definition Audio S/PDIF audio interface
LAN	<ul style="list-style-type: none"> Intel® I210 PCI Express Gigabit Ethernet controller Intel® I217LM with iAMT9.0 Gigabit Ethernet Phy (HM101-QM87) Intel® I217LM Gigabit Ethernet Phy (HM101-HM86) Integrated 10/100/1000 transceiver Fully compliant with IEEE 802.3, IEEE 802.3u, IEEE 802.3ab
Serial ATA	<ul style="list-style-type: none"> 2 SATA 3.0 ports with data transfer rate up to 6Gb/s <ul style="list-style-type: none"> - SATA port 4 provides adequate space for SATA DOM Integrated Advanced Host Controller Interface (AHCI) controller Supports RAID 0/1 (HM101-QM87) Supports Intel® Smart Response Technology (HM101-QM87)
Intel® Active Management Technology - AMT (HM101-QM87)	<ul style="list-style-type: none"> Supports iAMT9.0 Out-of-band system access Remote troubleshooting and recovery Hardware-based agent presence checking Proactive alerting Remote hardware and software asset tracking
Rear Panel I/O Ports	<ul style="list-style-type: none"> 1 12V DC-in jack (default) or 4-pin power connector (optional) 2 DB-9 RS232 serial ports 1 HDMI port 1 DVI-I port 2 RJ45 LAN ports 2 USB 2.0 ports 2 USB 3.0 ports Line-in, Line-out and mic-in jacks
I/O Connectors	<ul style="list-style-type: none"> 2 connectors for 4 external USB 2.0/1.1 ports 1 LVDS LCD panel connector 1 LCD/inverter power connector 1 DP connector <ul style="list-style-type: none"> - EXT-DP riser card supports 1 external DP port* (optional) 1 4-bit input and 4-bit output Digital I/O connector 1 Digital I/O power connector 1 front audio connector for line-out and mic-in jacks 1 S/PDIF connector 2 Serial ATA connectors 2 Serial ATA power connectors 1 LPC connector 1 chassis intrusion connector 1 front panel connector 2 fan connectors
Trusted Platform Module - TPM (optional)	<ul style="list-style-type: none"> Provides a Trusted PC for secure transactions Provides software license protection, enforcement and password protection
BIOS	<ul style="list-style-type: none"> AMI BIOS <ul style="list-style-type: none"> - 64Mbit SPI BIOS
Energy Efficient Design	<ul style="list-style-type: none"> Supports ErP Lot6 power saving (optional) Supports ACPI System Power Management Wake-On-Events include: <ul style="list-style-type: none"> - Wake-On-USB KB/Mouse - Wake-On-LAN - RTC timer to power-on the system AC power failure recovery
Damage Free Intelligence	<ul style="list-style-type: none"> Monitors CPU/system temperature and overheat alarm Monitors VCore/12V/5V/DDR voltages and failure alarm Monitors CPU/system fan speed and failure alarm Read back capability that displays temperature, voltage and fan speed Watchdog timer function
Power Consumption	<ul style="list-style-type: none"> TBD
Temperature	<ul style="list-style-type: none"> Operating: 0°C to 60°C Storage: -20°C to 85°C
Humidity	<ul style="list-style-type: none"> 5% to 90%

OS Support	<ul style="list-style-type: none"> • Windows XP Professional x86 & SP3 (32-bit) (limited function) • Windows 7 Ultimate x86 & SP1 (32-bit) • Windows 7 Ultimate x64 & SP1 (64-bit) • Windows 8 Enterprise x86 (32-bit) • Windows 8 Enterprise x64 (64-bit)
Dimensions	<ul style="list-style-type: none"> • Mini-ITX form factor • 170mm (6.7") x 170mm (6.7")
Certification	<ul style="list-style-type: none"> • CE, FCC Class B, RoHS, UL

**Note:**

*Optional and is not supported in standard model. Please contact your sales representative for more information.

Features

• Watchdog Timer

The Watchdog Timer function allows your application to regularly “clear” the system at the set time interval. If the system hangs or fails to function, it will reset at the set time interval so that your system will continue to operate.

• DDR3L

DDR3L is a higher performance DDR3 SDRAM interface providing less voltage and higher speed successor. DDR3L SDRAM modules support 1333/1600MHz for DDR modules. DDR3L delivers increased system bandwidth and improved performance to provide its higher bandwidth and its increase in performance at a lower power.

• Graphics

The integrated Intel® HD graphics engine delivers an excellent blend of graphics performance and features to meet business needs. It provides excellent video and 3D graphics with outstanding graphics responsiveness. These enhancements deliver the performance and compatibility needed for today’s and tomorrow’s business applications. Supports HDMI, DVI-I, LVDS and DP interfaces for display outputs.

• PCI Express

PCI Express is a high bandwidth I/O infrastructure that possesses the ability to scale speeds by forming multiple lanes. The PCI Express architecture also supports high performance graphics infrastructure by enhancing the capability of a PCIe x16 Gen 3 at 16GB/s bandwidth.

• Serial ATA

Serial ATA is a storage interface that is compliant with SATA 1.0a specification. With speed of up to 6Gb/s (SATA 3.0), it improves hard drive performance faster than the standard parallel ATA whose data transfer rate is 100MB/s. The bandwidth of the SATA 3.0 will be limited by carrier board design.

• Gigabit LAN

Two Intel® Gigabit LAN controllers (Intel® I210 PCI Express Gigabit Ethernet controller and Intel® I217LM Gigabit Ethernet Phy) support up to 1Gbps data transmission.

• Audio

The Realtek ALC886 audio codec provides 5.1-channel High Definition audio output.

• Wake-On-LAN

This feature allows the network to remotely wake up a Soft Power Down (Soft-Off) PC. It is supported via the onboard LAN port or via a PCI LAN card that uses the PCI PME (Power Management Event) signal. However, if your system is in the Suspend mode, you can power-on the system only through an IRQ or DMA interrupt.

**Important:**

The 5V_standby power source of your power supply must support $\geq 720\text{mA}$.

• Wake-On-USB

This function allows you to use a USB keyboard or USB mouse to wake up a system from the S3 (STR - Suspend To RAM) state.

**Important:**

If you are using the Wake-On-USB Keyboard/Mouse function for 2 USB ports, the 5V_standby power source of your power supply must support $\geq 1.5\text{A}$. For 3 or more USB ports, the 5V_standby power source of your power supply must support $\geq 2\text{A}$.

• ACPI STR

The system board is designed to meet the ACPI (Advanced Configuration and Power Interface) specification. ACPI has energy saving features that enables PCs to implement Power Management and Plug-and-Play with operating systems that support OS Direct Power Management. ACPI when enabled in the Power Management Setup will allow you to use the Suspend to RAM function.

With the Suspend to RAM function enabled, you can power-off the system at once by pressing the power button or selecting "Standby" when you shut down Windows® without having to go through the sometimes tiresome process of closing files, applications and operating system. This is because the system is capable of storing all programs and data files during the entire operating session into RAM (Random Access Memory) when it powers-off. The operating session will resume exactly where you left off the next time you power-on the system.

**Important:**

The 5V_standby power source of your power supply must support $\geq 720\text{mA}$.

• RTC Timer

The RTC installed on the system board allows your system to automatically power-on on the set date and time.

• Power Failure Recovery

When power returns after an AC power failure, you may choose to either power-on the system manually or let the system power-on automatically.

• USB

The system board supports the new USB 3.0. It is capable of running at a maximum transmission speed of up to 5 Gbit/s (625 MB/s) and is faster than USB 2.0 (480 Mbit/s, or 60 MB/s) and USB 1.1 (12Mb/s). USB 3.0 reduces the time required for data transmission, reduces power consumption, and is backward compatible with USB 2.0. It is a marked improvement in device transfer speeds between your computer and a wide range of simultaneously accessible external Plug and Play peripherals.

Chapter 2 - Hardware Installation

Board Layout

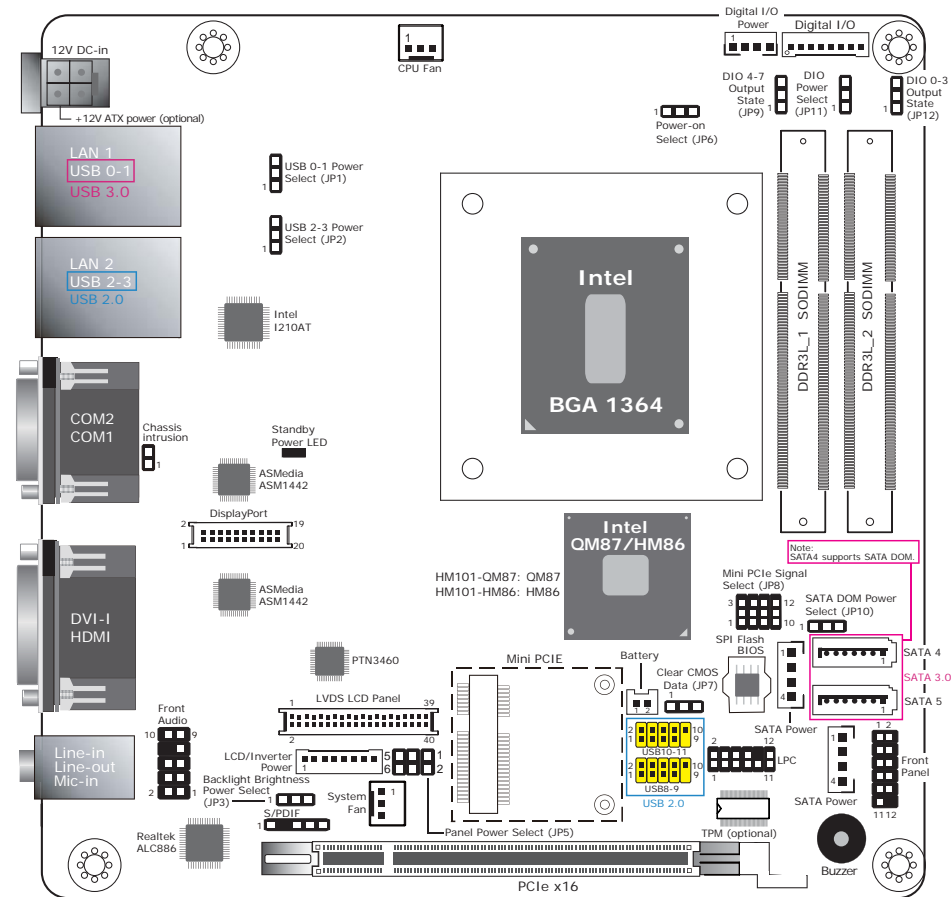

Important: Electrostatic discharge (ESD) can damage your board, processor, disk drives, add-in boards, and other components. Perform installation procedures at an ESD workstation only. If such a station is not available, you can provide some ESD protection by wearing an antistatic wrist strap and attaching it to a metal part of the system chassis. If a wrist strap is unavailable, establish and maintain contact with the system chassis throughout any procedures requiring ESD protection.

System Memory



Important: When the Standby Power LED lights red, it indicates that there is power on the system board. Power-off the PC then unplug the power cord prior to installing any devices. Failure to do so will cause severe damage to the motherboard and components.

- Rear I/O
- Onboard I/O
- Storage
- Expansion

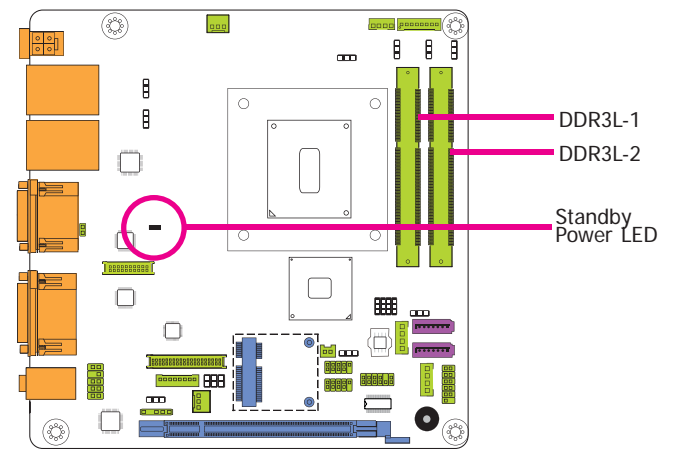

Features

- Two 204-pin DDR3L SODIMM sockets
- Supports DDR3L 1333/1600MHz
- Supports dual channel memory interface
- Supports up to 16GB system memory

The system board supports the following memory interface.

Single Channel (SC)

Data will be accessed in chunks of 64 bits (8B) from the memory channels.

Dual Channel (DC)

Data will be accessed in chunks of 128 bits from the memory channels. Dual channel provides better system performance because it doubles the data transfer rate.

Single Channel	DIMMs are on the same channel. DIMMs in a channel can be identical or completely different. However, we highly recommend using identical DIMMs. Not all slots need to be populated.
Dual Channel	DIMMs of the same memory configuration are on different channels.



Important:

You can populate either Channel A or Channel B first.

Installing the DIMM Module



Note:

The system board used in the following illustrations may not resemble the actual board. These illustrations are for reference only.

1. Make sure the PC and all other peripheral devices connected to it has been powered down.
2. Disconnect all power cords and cables.
3. Locate the DIMM socket on the system board.
4. Push the "ejector tabs" which are at the ends of the socket to the side.



5. Note how the module is keyed to the socket.

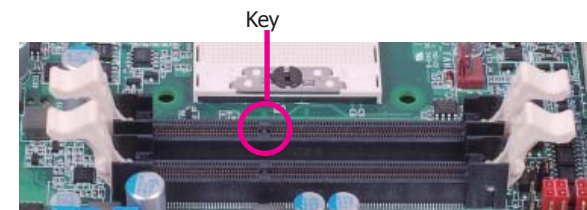
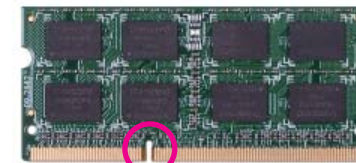

- Grasping the module by its edges, position the module above the socket with the “notch” in the module aligned with the “key” on the socket. The keying mechanism ensures the module can be plugged into the socket in only one way.



- Seat the module vertically, pressing it down firmly until it is completely seated in the socket. The ejector tabs at the ends of the socket will automatically snap into the locked position to hold the module in place.



Installing the Fan and Heat Sink

The CPU must be kept cool by using a CPU fan with heat sink. Without sufficient air circulation across the CPU and heat sink, the CPU will overheat damaging both the CPU and system board.



Note:

- Use only certified fan and heat sink.
- Your fan and heat sink package usually contains the fan and heat sink assembly, and an installation guide. If the installation procedure in the installation guide differs from the one in this section, please follow the installation guide in the package.

- On the solder side of the board, match the retention module base to the mounting holes around the CPU socket.

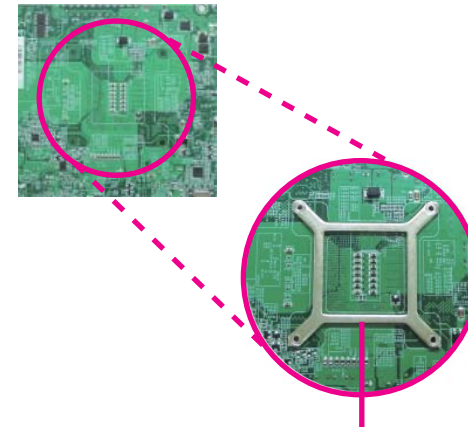

Retention module base

- Turn to the component side of the board making sure the retention module base is positioned and fitted properly under the board.
- Apply a thin layer of thermal paste on top of the CPU. Do not spread the paste all over the surface. When you later place the heat sink on top, the compound will disperse evenly.

- Place the fan / heat sink assembly on top of the CPU. The 4 screws around the heat sink must match the screw holes of the retention module base. We strongly recommend using this type of fan / heat sink assembly because it provides adequate cooling to the components of the system board.

Turn each Phillips head screw half way down first to initially stabilize the heat sink onto the board, then finally tighten each screw.



Important:

Do not turn the first screw all the way down followed by the next and so on. This is to avoid imbalance which might cause cracks or fractures to the CPU and/or heat sink assembly.



Mounting screw

- Connect the CPU fan's cable connector to the CPU fan connector on the system board.



CPU fan cable

Jumper Settings

Clear CMOS Data

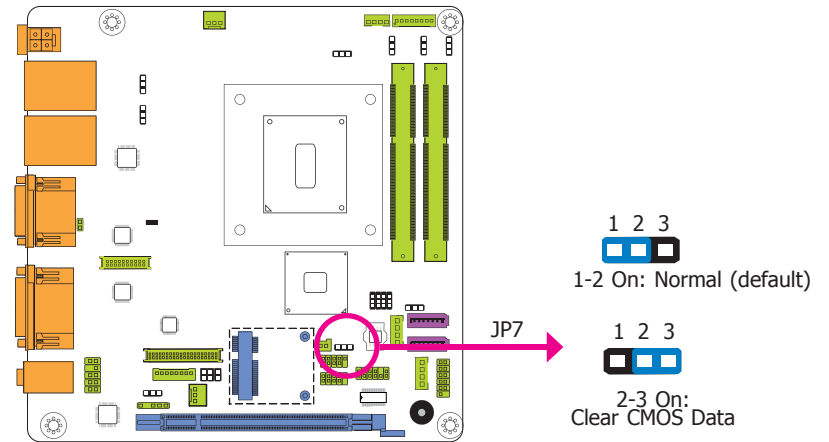

If you encounter the followings,

- CMOS data becomes corrupted.
- You forgot the supervisor or user password.

you can reconfigure the system with the default values stored in the ROM BIOS.

To load the default values stored in the ROM BIOS, please follow the steps below.

- Power-off the system and unplug the power cord.
- Set JP7 pins 2 and 3 to On. Wait for a few seconds and set JP7 back to its default setting, pins 1 and 2 On.
- Now plug the power cord and power-on the system.

USB Power Select

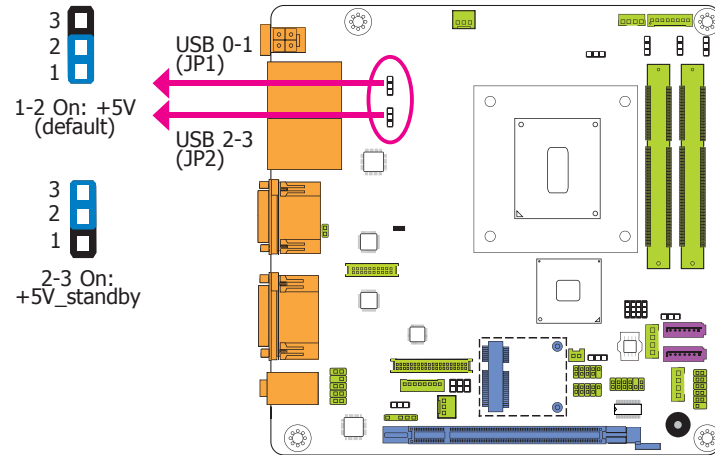

JP1 and JP2 are used to select the power of the USB ports. Selecting +5V_standby will allow you to use a USB device to wake up the system.

**Important:**

If you are using the Wake-On-USB Keyboard/Mouse function for 2 USB ports, the +5V_standby power source of your power supply must support $\geq 1.5A$. For 3 or more USB ports, the +5V_standby power source of your power supply must support $\geq 2A$.

Power-on Select

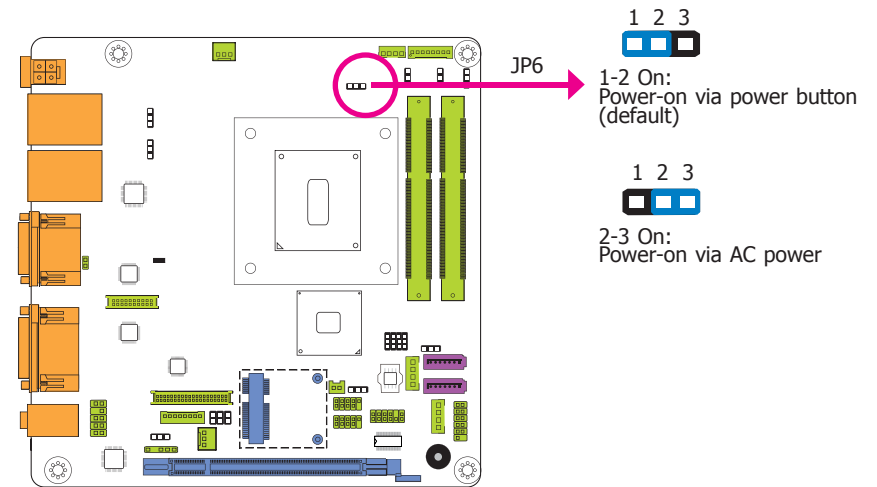

JP6 is used to select the method of powering-on the system. If you want the system to power-on whenever AC power comes in, set JP6 pins 2 and 3 to On. If you want to use the power button, set pins 1 and 2 to On.

When using JP6 "Power On" feature to power the system back on after a power failure occurs, the system may not power on if the power lost is resumed within 5 seconds (power flicker).

Mini PCIe Signal Select

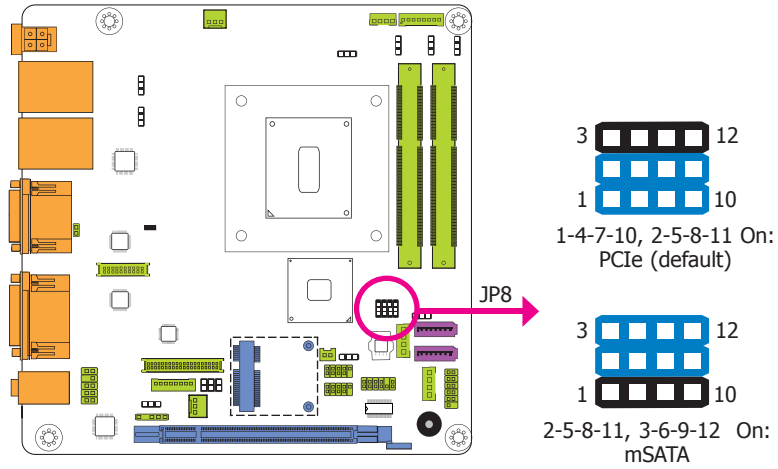

JP8 is used to select the Mini PCIe signal.

SATA DOM Power Select

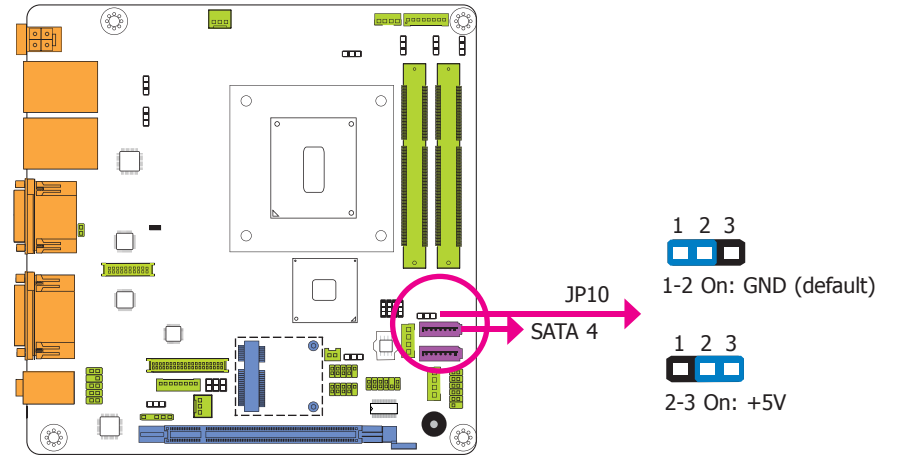

JP10 is used to select the power level of SATA DOM.



Note:
SATA port 4 provides adequate space for SATA DOM.

Panel Power Select

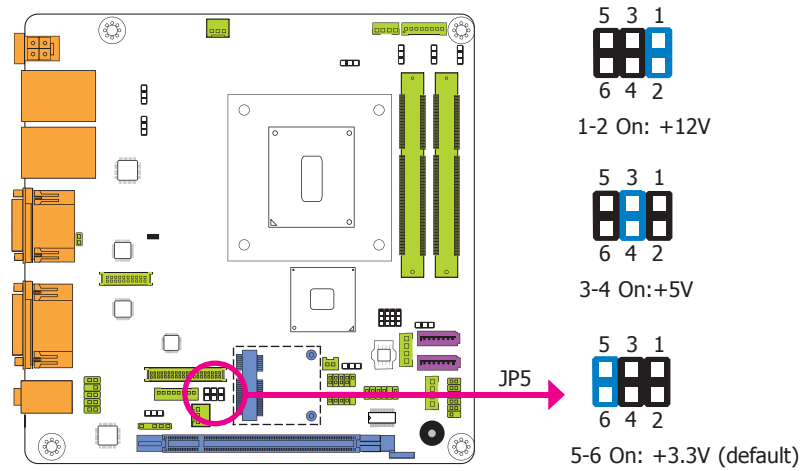

JP5 is used to select the power supplied with the LCD panel.

**Important:**

Before powering-on the system, make sure that the power settings of JP5 match the LCD panel's specification. Selecting the incorrect voltage will seriously damage the LCD panel.

Backlight Brightness Power Select

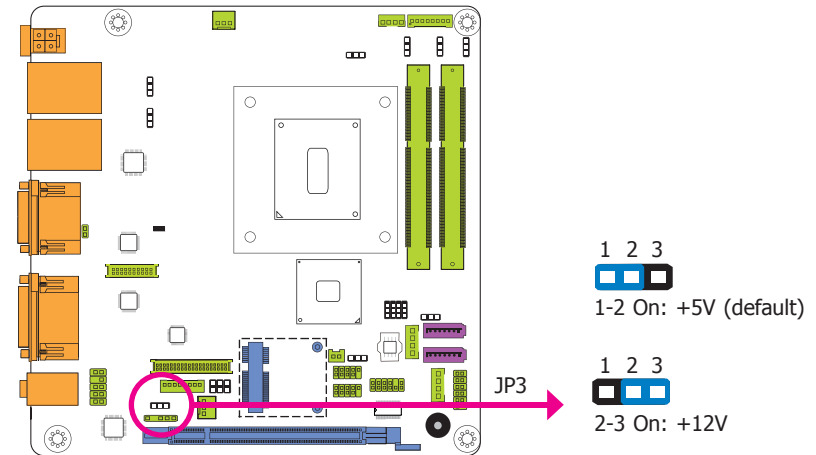

JP3 is used to select the power level of backlight brightness control: +12V or +5V.

**Important:**

Before powering-on the system, make sure that the power settings of JP3 match the power specification of backlight control. Selecting the incorrect voltage will seriously damage the backlight.

Digital I/O Power Select

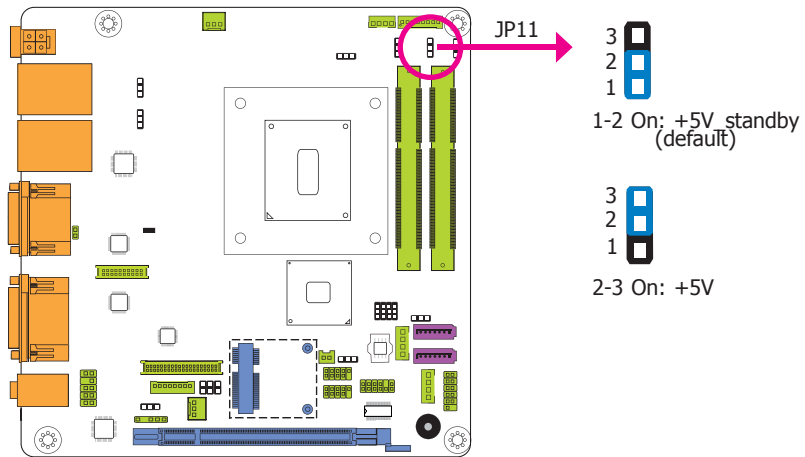

JP11 is used to select the power of Digital I/O signal.

Digital I/O Output State

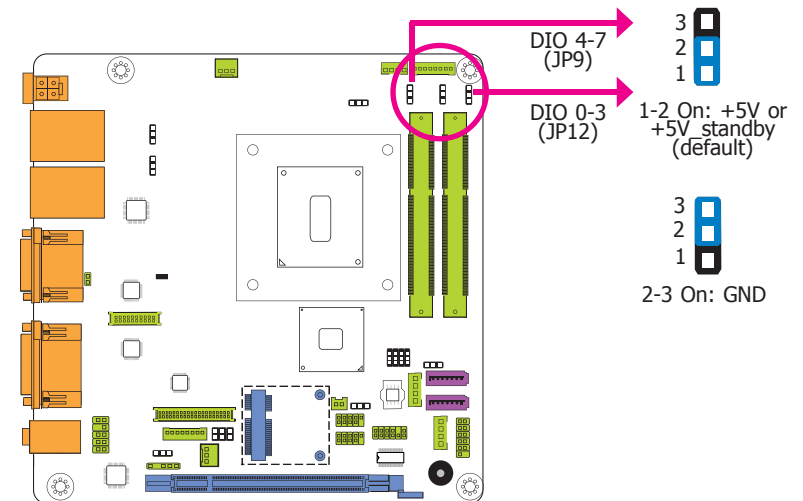

Based on the power level of DIO (Digital I/O) selected on JP11, JP12 (DIO pin 0-3) and JP9 (DIO pin 4-7) are used to select the output state of Digital I/O: pull high or pull low. When selecting pull high, the power selection will be the same as the JP11's setting.

Rear Panel I/O Ports

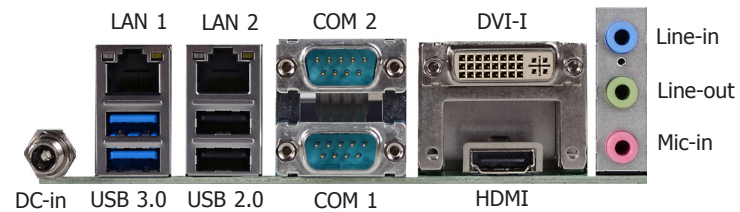

The rear panel I/O ports consist of the following:

- 1 12V DC-in jack (default) or 4-pin ATX power connector (optional)
- 2 Serial COM ports
- 1 HDMI port
- 1 DVI-I port
- 2 RJ45 LAN ports
- 2 USB 2.0 ports
- 2 USB 3.0 ports
- Line-in jack
- Line-out jack
- Mic-in jack

12V DC-in

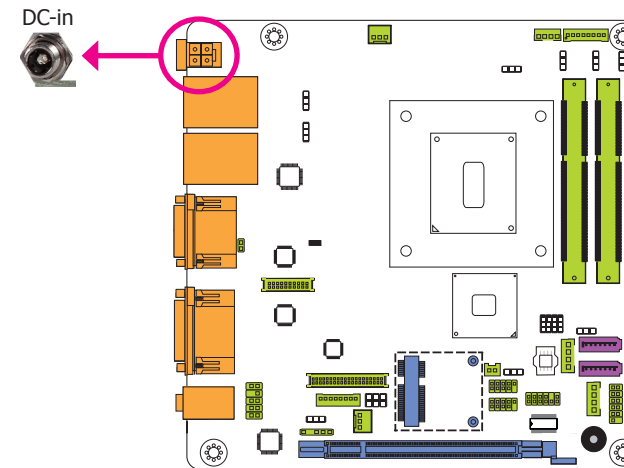

This jack provides maximum of 100W power and is considered a low power solution. Connect a DC power cord to this jack. Use a power adapter with 12V DC output voltage. Using a voltage higher than the recommended one may fail to boot the system or cause damage to the system board.

The 12V DC-in jack on the system board co-lays with a 4-pin ATX power connector (optional) as the figure illustrated below.

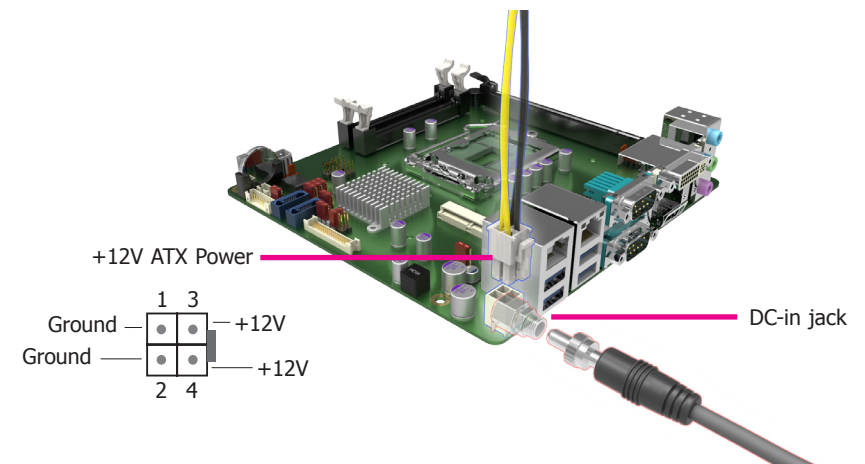

COM (Serial) Ports

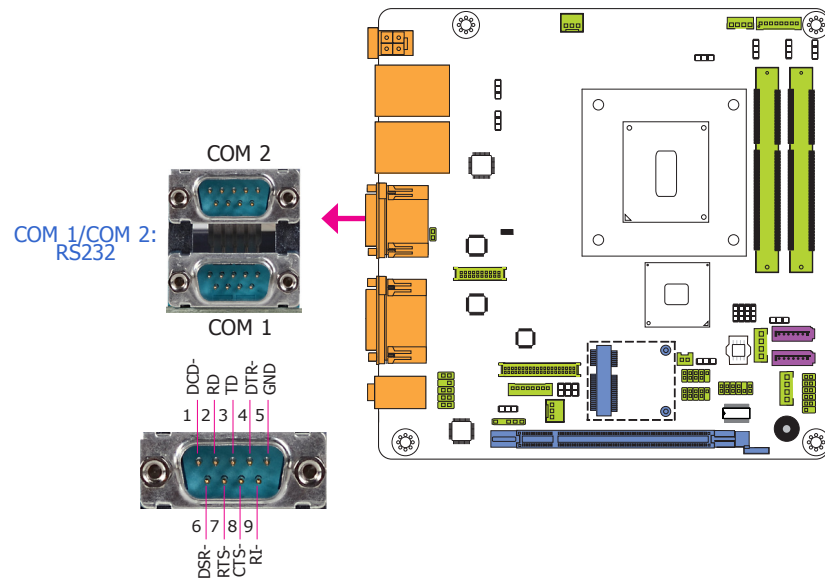

COM 1 and COM 2 are fixed at RS232.

The serial ports are asynchronous communication ports with 16C550A-compatible UARTs that can be used with modems, serial printers, remote display terminals, and other serial devices.

Connecting External Serial Ports

Your COM port may come mounted on a card-edge bracket. Install the card-edge bracket to an available slot at the rear of the system chassis then insert the serial port cable to the COM connector. Make sure the colored stripe on the ribbon cable is aligned with pin 1 of the COM connector.

BIOS Setting

Configure the serial COM ports in the Advanced menu ("Super IO Configuration" submenu) of the BIOS. Refer to the chapter 3 for more information.

Graphics Interfaces

The display ports consist of the following:

- 1 DVI-I port
- 1 HDMI port

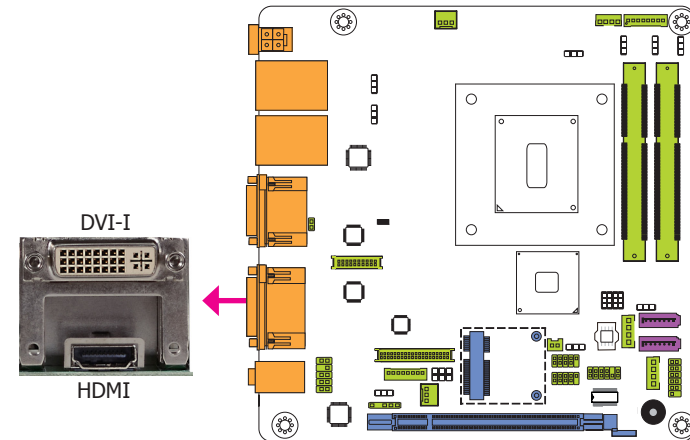

DVI-I Port

The DVI-I port is used to connect an LCD monitor. This port supports DVI-D signal only. Connect the display device's cable connector to the DVI-I port. After plugging the cable connector into the port, gently tighten the cable screws to hold the connector in place.

HDMI Port

The HDMI port which carries both digital audio and video signals is used to connect a LCD monitor or digital TV that has the HDMI port.

BIOS Setting

Configure the display devices in the Chipset menu ("System Agent Configuration" submenu) of the BIOS. Refer to the chapter 3 for more information.

RJ45 LAN Ports

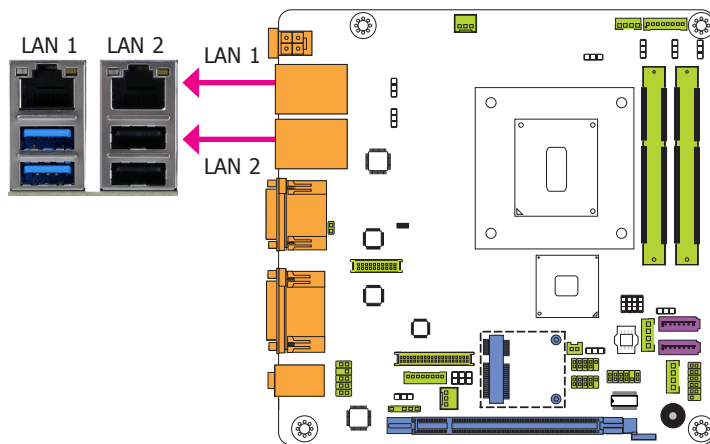

Features

- Intel® I210 PCI Express Gigabit Ethernet controller
- Intel® I217LM with iAMT9.0 Gigabit Ethernet Phy (HM101-QM87)
- Intel® I217LM Gigabit Ethernet Phy (HM101-HM86)

The two LAN ports allow the system board to connect to a local area network by means of a network hub.

BIOS Setting

Configure the onboard LAN ports in the Chipset menu ("PCH-IO Configuration" submenu) of the BIOS. Refer to the chapter 3 for more information.

Driver Installation

Install the LAN drivers. Refer to the chapter 4 for more information.

USB Ports

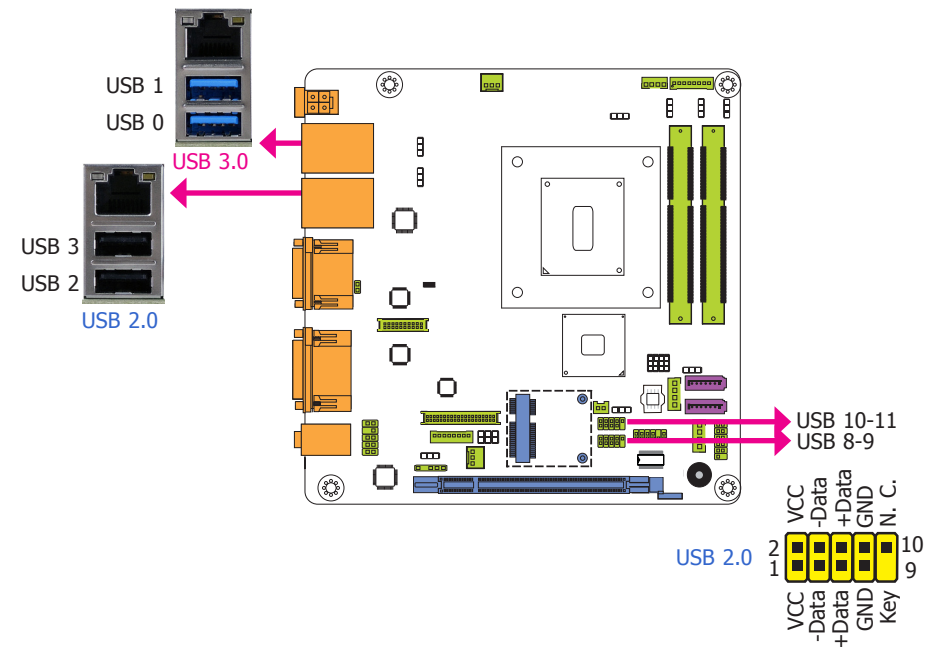

The USB device allows data exchange between your computer and a wide range of simultaneously accessible external Plug and Play peripherals.

The system board is equipped with two onboard USB 3.0 ports (USB 0-1) and two onboard USB 2.0 ports (USB 2-3). The 10-pin connectors allow you to connect 4 additional USB 2.0/1.1 ports (USB 8-9/10-11). The additional USB ports may be mounted on a card-edge bracket. Install the card-edge bracket to an available slot at the rear of the system chassis and then insert the USB port cables to a connector.

BIOS Setting

Configure these onboard USB devices in the Advanced menu ("USB Configuration" submenu) of the BIOS. Refer to the chapter 3 for more information.

Driver Installation

You may need to install the proper drivers in your system operation to use the USB device. Refer to your operating system's manual or documentation for more information.

Wake-On-USB Keyboard/Mouse

The Wake-On-USB Keyboard/Mouse function allows you to use a USB keyboard or USB mouse to wake up a system from the S3 (STR - Suspend To RAM) state. To use this function:

- **Jumper Setting**

JP1 and JP2 must be set to "2-3 On: +5V_standby". Refer to "USB Power Select" in this chapter for more information.



Important:

If you are using the Wake-On-USB Keyboard/Mouse function for 2 USB ports, the +5V_standby power source of your power supply must support $\geq 1.5A$. For 3 or more USB ports, the +5V_standby power source of your power supply must support $\geq 2A$.

Audio

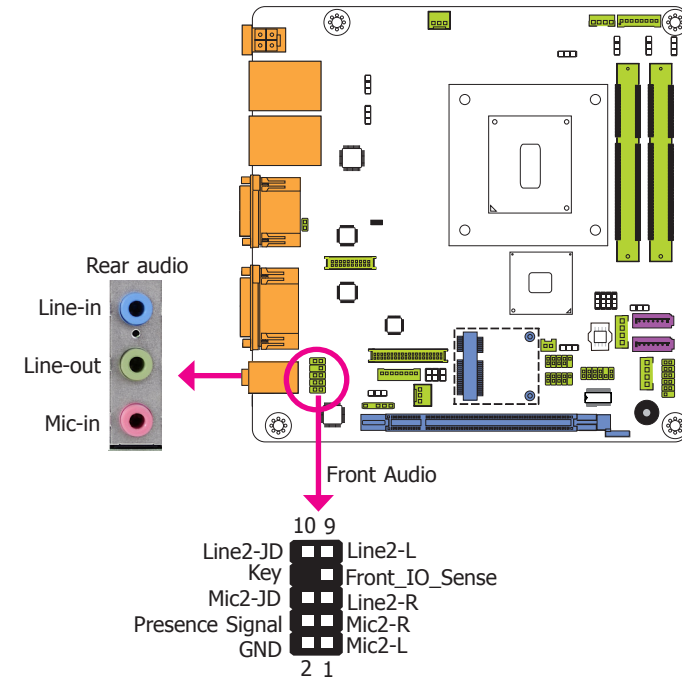

Rear Audio

The system board is equipped with 3 audio jacks. A jack is a one-hole connecting interface for inserting a plug.

- **Line-in Jack (Light Blue)**
This jack is used to connect any audio devices such as Hi-fi set, CD player, tape player, AM/FM radio tuner, synthesizer, etc.
- **Line-out Jack (Lime)**
This jack is used to connect a headphone or external speakers.
- **Mic-in Jack (Pink)**
This jack is used to connect an external microphone.

Front Audio

The front audio connector allows you to connect to the second line-out and mic-in jacks that are at the front panel of your system.

Driver Installation

Install the audio driver. Refer to the chapter 4 for more information.

I/O Connectors

SATA (Serial ATA) Connectors

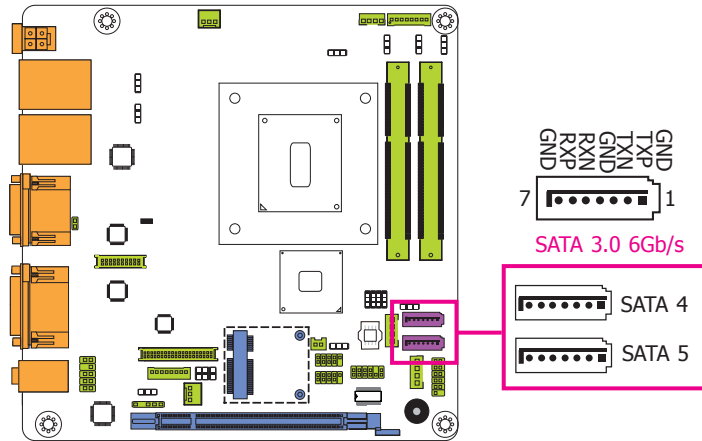

Features

- 2 Serial ATA 3.0 ports with data transfer rate up to 6Gb/s (SATA 4 and SATA 5)
- Integrated Advanced Host Controller Interface (AHCI) controller
- Supports RAID 0/1 (HM101-QM87)
- Supports Intel® Smart Response Technology (HM101-QM87)

The Serial ATA connectors are used to connect Serial ATA devices. Connect one end of the Serial ATA data cable to a SATA connector and the other end to your Serial ATA device.

The system board package comes with a power cable that must be connected from the system board's peripheral power connector to the SATA drive's power connector in order to provide power to the drive.

BIOS Setting

Configure the Serial ATA drives in the Advanced menu ("SATA Configuration" submenu) of the BIOS. Refer to the chapter 3 for more information.



Note:

SATA port 4 provides adequate space for SATA DOM.

SATA (Serial ATA) Power Connectors

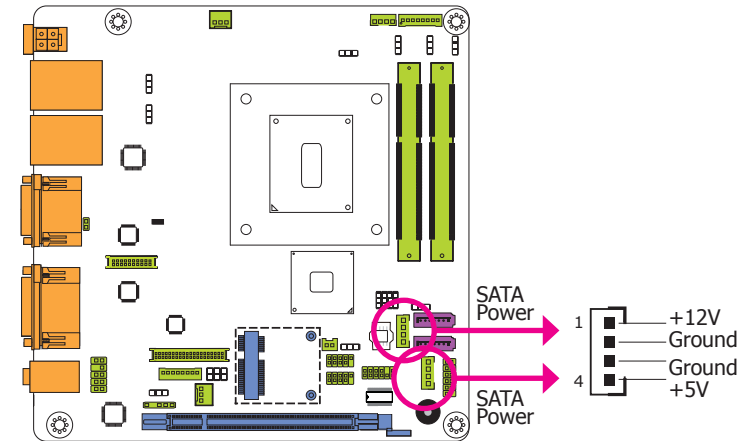

The SATA power connector supplies power to the SATA drive. Connect one end of the provided power cable to the SATA power connector and the other end to your storage device.

Cooling Fan Connectors

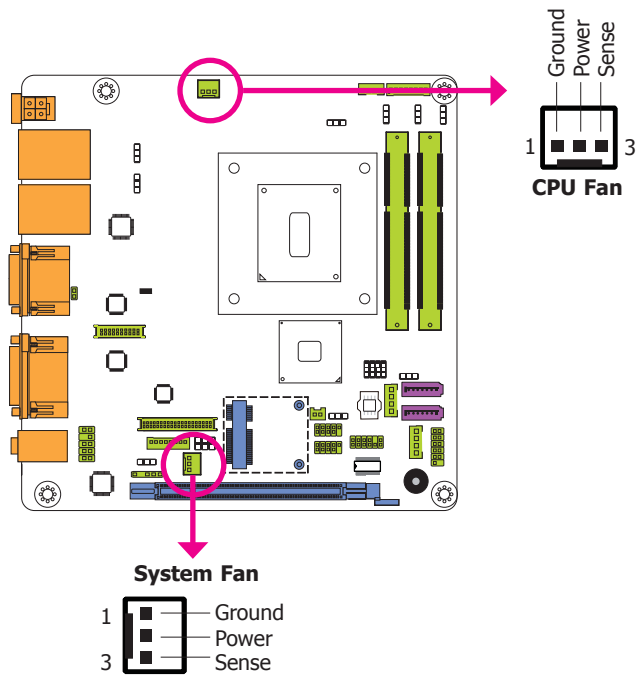

The fan connectors are used to connect cooling fans. The cooling fans will provide adequate airflow throughout the chassis to prevent overheating the CPU and system board components.

BIOS Setting

The Advanced menu ("PC Health Status" submenu) of the BIOS will display the current speed of the cooling fans. Refer to the chapter 3 for more information.

Digital I/O Connector

Digital I/O Power Connector

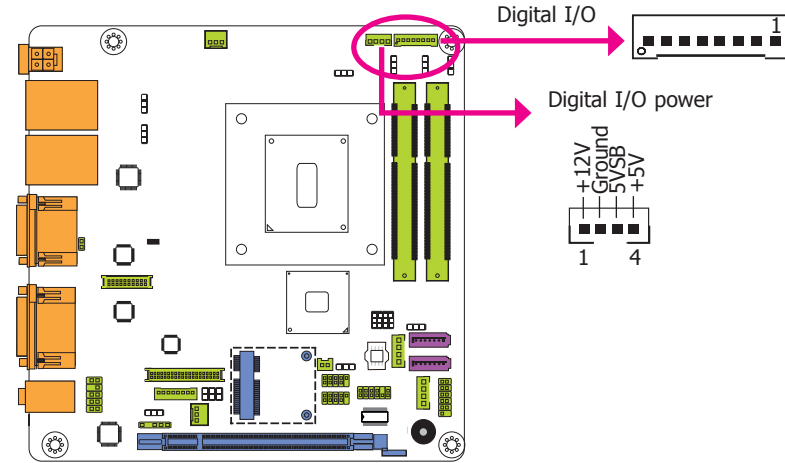

The 4-bit input and 4-bit output Digital I/O connector provides powering-on function to external devices that are connected to these connectors.

Digital I/O Connector

Pins	Function
1	DIO7
2	DIO6
3	DIO5
4	DIO4
5	DIO3
6	DIO2
7	DIO1
8	DIO0

Front Panel Connector

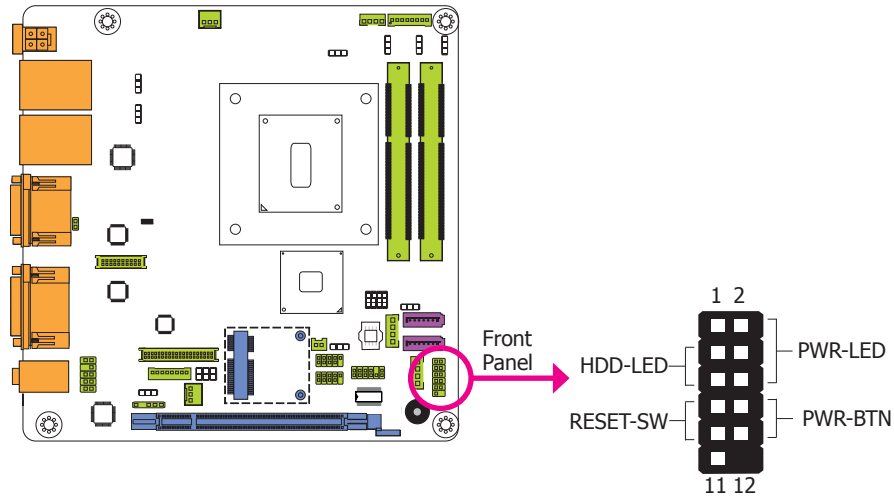

HDD-LED - HDD LED

This LED will light when the hard drive is being accessed.

RESET-SW - Reset Switch

This switch allows you to reboot without having to power off the system.

PWR-BTN - Power Switch

This switch is used to power on or off the system.

PWR-LED - Power/Standby LED

When the system's power is on, this LED will light. When the system is in the S1 (POS - Power On Suspend) state, it will blink every second. When the system is in the S3 (STR - Suspend To RAM) state, it will blink every 4 seconds.

	Pin	Pin Assignment		Pin	Pin Assignment
HDD-LED	3	HDD Power	PWR-LED	2	LED Power
	5	Signal		4	LED Power
RESET-SW	7	Ground	PWR-BTN	6	Signal
	9	RST Signal		8	Ground
	11	N.C.		10	Signal

Chassis Intrusion Connector

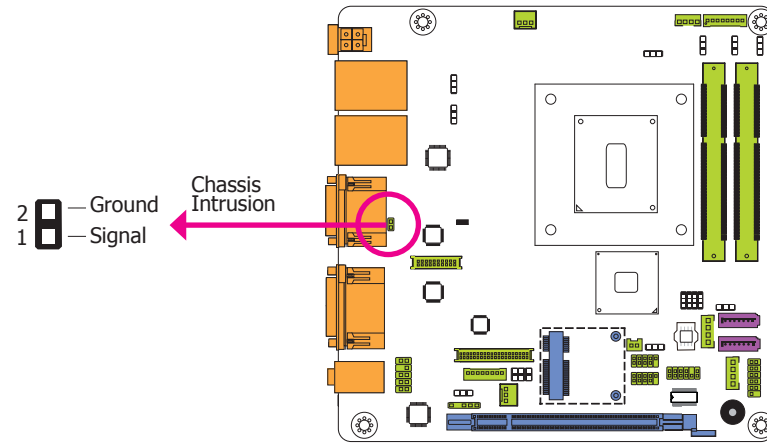

The board supports the chassis intrusion detection function. Connect the chassis intrusion sensor cable from the chassis to this connector. When the system's power is on and a chassis intrusion occurred, an alarm will sound. When the system's power is off and a chassis intrusion occurred, the alarm will sound only when the system restarts.

LVDS LCD Panel Connector LCD/Inverter Power Connector

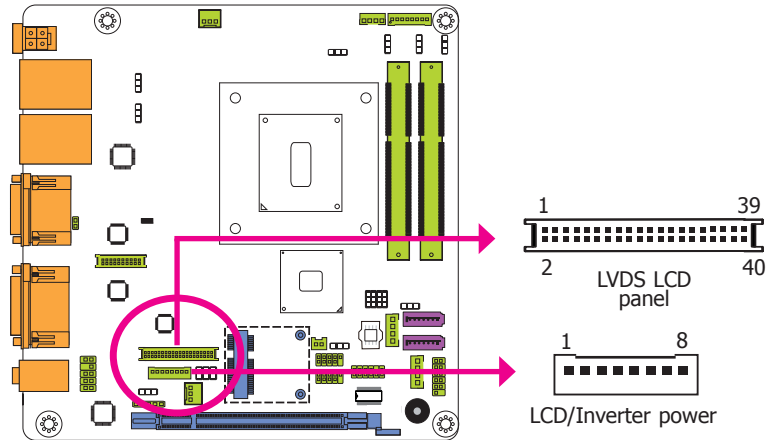

The system board allows you to connect a LCD Display Panel by means of the LVDS LCD panel connectors and the LCD/Inverter power connectors. These connectors transmit video signals and power from the system board to the LCD Display Panel.

Refer to the right side for the pin functions of these connectors.

Jumper Settings

Refer to the “Jumper Settings” section in this chapter for settings relevant to the LCD panel.

LVDS LCD Panel Connector

Pins	Function	Pins	Function
1	GND	2	GND
3	LVDS_Out3+	4	LVDS_Out7+
5	LVDS_Out3-	6	LVDS_Out7-
7	GND	8	GND
9	LVDS_Out2+	10	LVDS_Out6+
11	LVDS_Out2-	12	LVDS_Out6-
13	GND	14	GND
15	LVDS_Out1+	16	LVDS_Out5+
17	LVDS_Out1-	18	LVDS_Out5-
19	GND	20	GND
21	LVDS_Out0+	22	LVDS_Out4+
23	LVDS_Out0-	24	LVDS_Out4-
25	GND	26	GND
27	LVDS_CLK1+	28	LVDS_CLK2+
29	LVDS_CLK1-	30	LVDS_CLK2-
31	GND	32	GND
33	LVDS_DDCCLK	34	N.C.
35	LVDS_DDCDTA	36	+3.3V
37	Panel Power	38	Panel Power
39	Panel Power	40	Panel Power

LCD/Inverter Power Connector

Pins	Function
1	GND
2	GND
3	Panel Inverter Brightness Voltage Control
4	Panel Power
5	+3.3V
6	Panel Backlight On/Off Control
7	+12V
8	+12V

Note:

DFI board's LVDS connector: Hirose DF13-40DP-1.25V(91)/40P/1.25mm; cable side connector: Hirose DF13-40DS-1.25C.

DisplayPort Connector

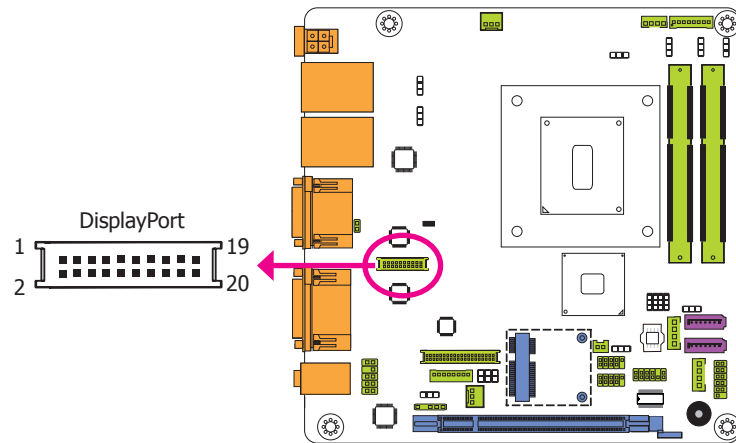

The DisplayPort connector is a digital display interface used to connect a display device to transmit digital communication of audio and video signals. The table shown below indicates the pin functions of the displayport connector.

Pins	Pin Assignment	Pins	Pin Assignment
1	DP_OUT1N	2	DP_OUT2N
3	DP_OUT1P	4	DP_OUT2P
5	GND1	6	GND4
7	DP_OUT0P	8	DP_OUT3N
9	DP_OUT0N	10	DP_OUT3P
11	GND2	12	GND5
13	DP_AUXP	14	DP_CLK
15	DP_AUXN	16	DP_DATA
17	GND3	18	GND6
19	DP_HPD	20	POWER2

Expansion Slots

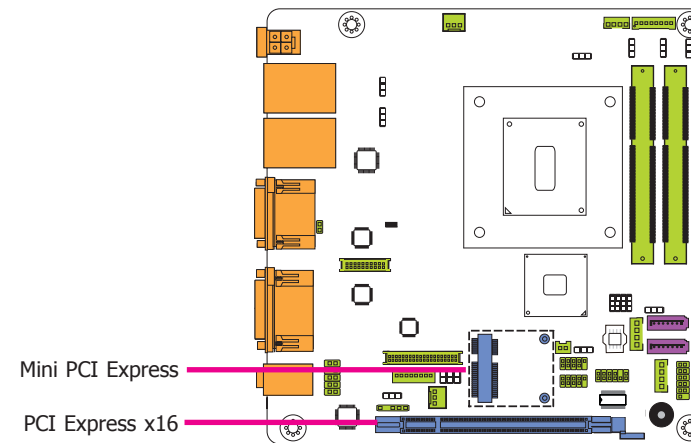

PCI Express x16 Slot

Install PCI Express x16 graphics card, that comply to the PCI Express specifications, into the PCI Express x16 slot. To install a graphics card into the x16 slot, align the graphics card above the slot then press it down firmly until it is completely seated in the slot. The retaining clip of the slot will automatically hold the graphics card in place.

Mini PCI Express Slot

The Mini PCIe socket is used to install a Mini PCIe card. Mini PCIe card is a small form factor PCI card with the same signal protocol, electrical definitions, and configuration definitions as the conventional PCI.

S/PDIF Connector

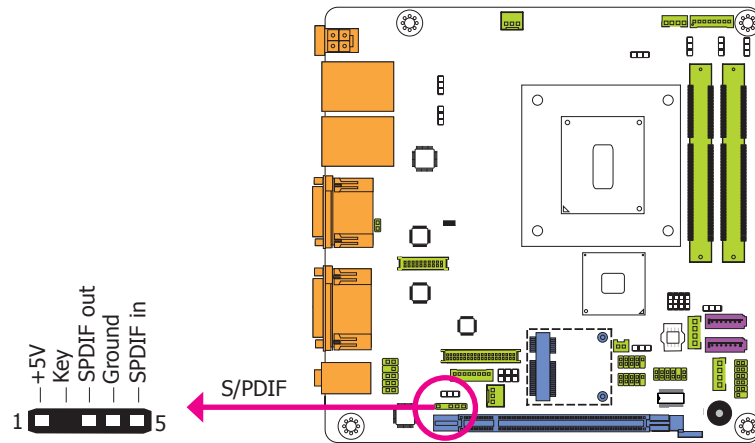

The S/PDIF connector is used to connect an external S/PDIF port. Your S/PDIF port may be mounted on a card-edge bracket. Install the card-edge bracket to an available slot at the rear of the system chassis then connect the audio cable to the S/PDIF connector. Make sure pin 1 of the audio cable is aligned with pin 1 of the S/PDIF connector.

Standby Power LED

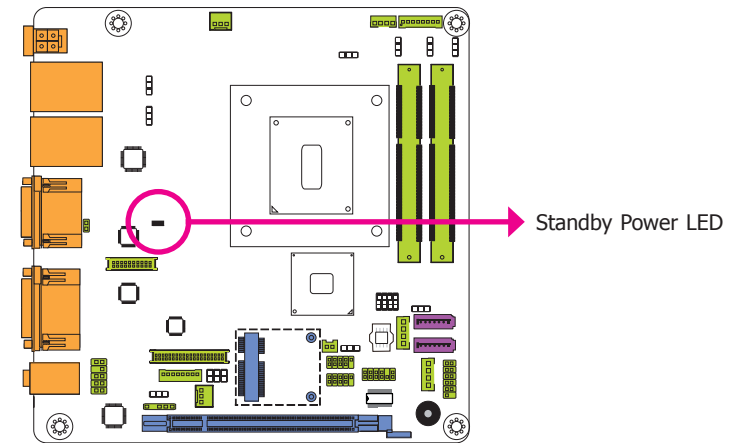

This LED will lit red when the system is in the standby mode. It indicates that there is power on the system board. Power-off the PC and then unplug the power cord prior to installing any devices. Failure to do so will cause severe damage to the motherboard and components.

Battery

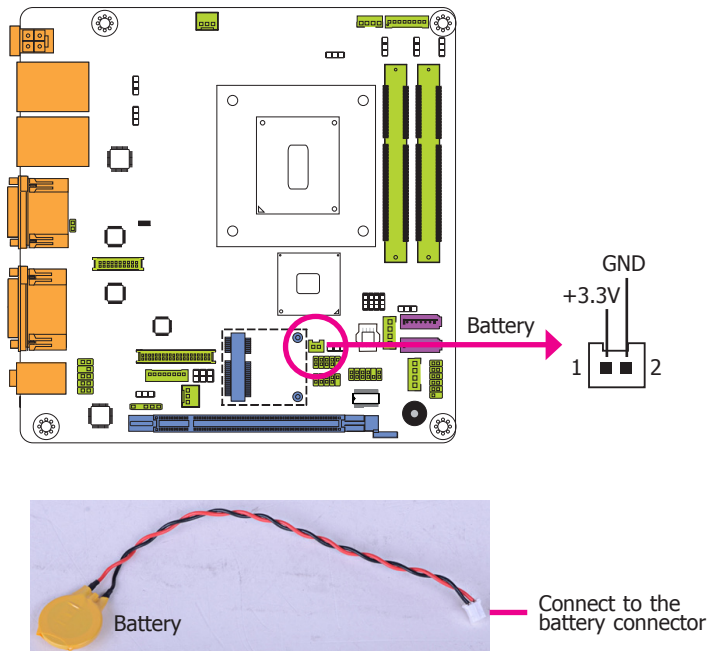

The lithium ion battery powers the real-time clock and CMOS memory. It is an auxiliary source of power when the main power is shut off.

Safety Measures

- Danger of explosion if battery incorrectly replaced.
- Replace only with the same or equivalent type recommend by the manufacturer.
- Dispose of used batteries according to local ordinance.

Chapter 3 - BIOS Setup

Overview

The BIOS is a program that takes care of the basic level of communication between the CPU and peripherals. It contains codes for various advanced features found in this system board. The BIOS allows you to configure the system and save the configuration in a battery-backed CMOS so that the data retains even when the power is off. In general, the information stored in the CMOS RAM of the EEPROM will stay unchanged unless a configuration change has been made such as a hard drive replaced or a device added.

It is possible that the CMOS battery will fail causing CMOS data loss. If this happens, you need to install a new CMOS battery and reconfigure the BIOS settings.



Note:

The BIOS is constantly updated to improve the performance of the system board; therefore the BIOS screens in this chapter may not appear the same as the actual one. These screens are for reference purpose only.

Default Configuration

Most of the configuration settings are either predefined according to the Load Optimal Defaults settings which are stored in the BIOS or are automatically detected and configured without requiring any actions. There are a few settings that you may need to change depending on your system configuration.

Entering the BIOS Setup Utility

The BIOS Setup Utility can only be operated from the keyboard and all commands are keyboard commands. The commands are available at the right side of each setup screen.

The BIOS Setup Utility does not require an operating system to run. After you power up the system, the BIOS message appears on the screen and the memory count begins. After the memory test, the message "Press DEL to run setup" will appear on the screen. If the message disappears before you respond, restart the system or press the "Reset" button. You may also restart the system by pressing the <Ctrl> <Alt> and keys simultaneously.

Legends

Keys	Function
Right and Left arrows	Moves the highlight left or right to select a menu.
Up and Down arrows	Moves the highlight up or down between submenu or fields.
<Esc>	Exit to the BIOS Setup Utility.
+ (plus key)	Scrolls forward through the values or options of the highlighted field.
- (minus key)	Scrolls backward through the values or options of the highlighted field.
Tab	Select a field.
<F1>	Displays general help
<F2>	Previous values
<F3>	Optimized defaults
<F4>	Saves and resets the setup program.
<Enter>	Press <Enter> to enter the highlighted submenu.

Scroll Bar

When a scroll bar appears to the right of the setup screen, it indicates that there are more available fields not shown on the screen. Use the up and down arrow keys to scroll through all the available fields.

Submenu

When "►" appears on the left of a particular field, it indicates that a submenu which contains additional options are available for that field. To display the submenu, move the highlight to that field and press <Enter>.

AMI BIOS Setup Utility

Main

The Main menu is the first screen that you will see when you enter the BIOS Setup Utility.

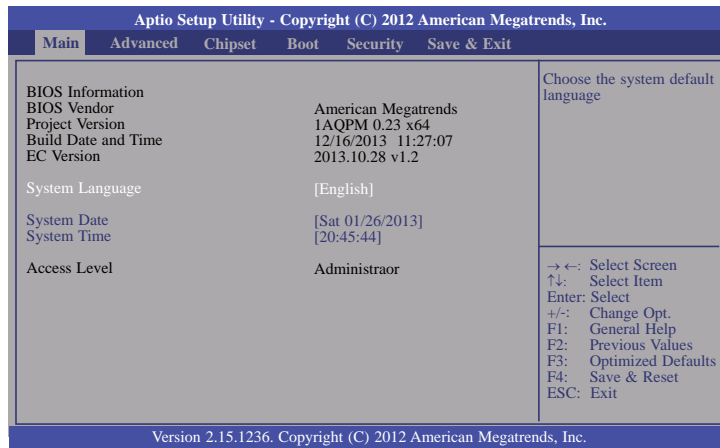

System Date

The date format is <day>, <month>, <date>, <year>. Day displays a day, from Sunday to Saturday. Month displays the month, from January to December. Date displays the date, from 1 to 31. Year displays the year, from 1980 to 2099.

System Time

The time format is <hour>, <minute>, <second>. The time is based on the 24-hour military-time clock. For example, 1 p.m. is 13:00:00. Hour displays hours from 00 to 23. Minute displays minutes from 00 to 59. Second displays seconds from 00 to 59.

Advanced

The Advanced menu allows you to configure your system for basic operation. Some entries are defaults required by the system board, while others, if enabled, will improve the performance of your system or let you set some features according to your preference.



Important:

Setting incorrect field values may cause the system to malfunction.

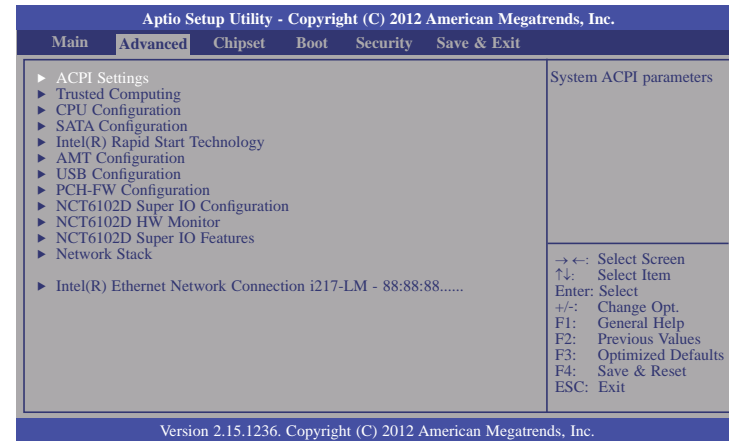

ACPI Settings

This section is used to configure the ACPI parameters.

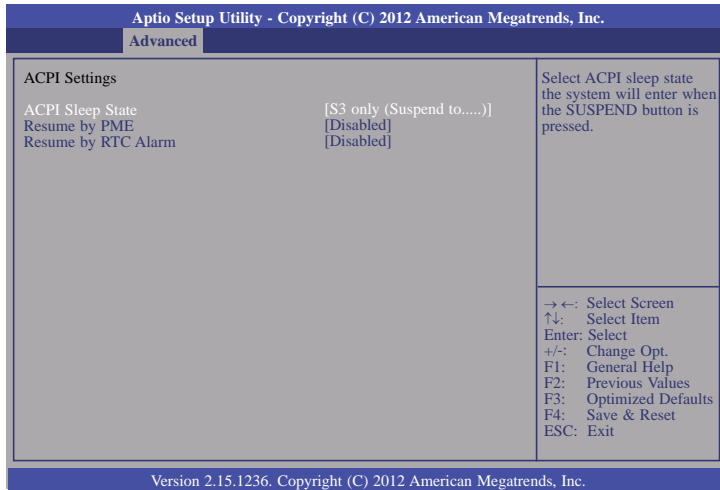

ACPI Sleep State

Selects the highest ACPI sleep state the system will enter when the Suspend button is pressed.

S3(STR) Enables the Suspend to RAM function.

Resume by PME

Enables this field to use the PME signal to wake up the system.

Resume by RTC Alarm

When Enabled, the system uses the RTC to generate a wakeup event.

Trusted Computing

This section configures settings relevant to Trusted Computing innovations.

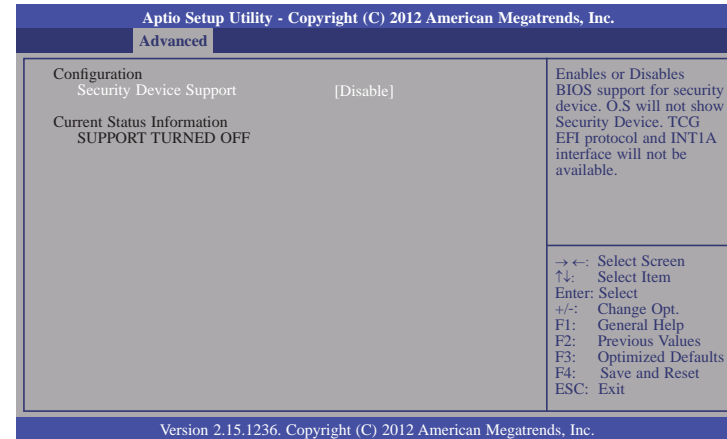

Security Device Support

This field is used to enable or disable BIOS supporting for the security device. O.S will not show the security device. TCG EFI protocol and INT1A interface will not be available.

CPU Configuration

This section is used to configure the CPU. It will also display the detected CPU information.

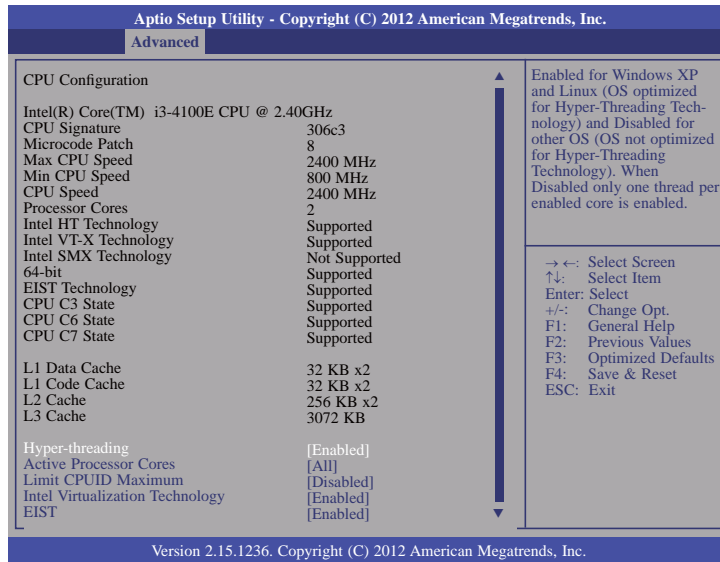

EIST

This field is used to enable or disable the Intel Enhanced SpeedStep Technology.

Hyper-threading

Enables this field for Windows XP and Linux which are optimized for Hyper-Threading technology. Select disabled for other OSes not optimized for Hyper-Threading technology. When disabled, only one thread per enabled core is enabled.

Active Processor Cores

Number of cores to enable in each processor package.

Limit CPUID Maximum

The CPUID instruction of some newer CPUs will return a value greater than 3. The default is Disabled because this problem does not exist in the Windows series operating systems. If you are using an operating system other than Windows, this problem may occur. To avoid this problem, enable this field to limit the return value to 3 or lesser than 3.

Intel Virtualization Technology

When this field is set to Enabled, the VMM can utilize the additional hardware capabilities provided by Vanderpool Technology.

SATA Configuration

This section is used to configure the settings of SATA device.

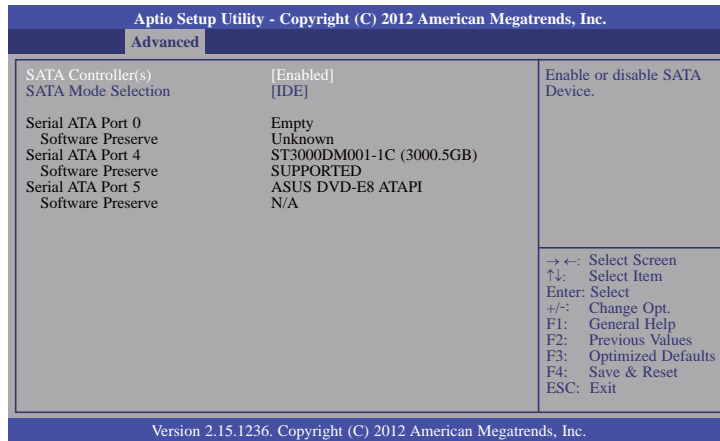

SATA Controller(s)

This field is used to enable or disable the Serial ATA devices.

SATA Mode Selection

The mode selection determines how the SATA controller(s) operates.

IDE Mode

This option configures the Serial ATA drives as Parallel ATA storage devices.

AHCI Mode

This option allows the Serial ATA devices to use AHCI (Advanced Host Controller Interface).

RAID Mode

This option allows the Serial ATA devices to use RAID.

When AHCI or RAID mode is selected in the SATA Mode Selection, it will display the following information:

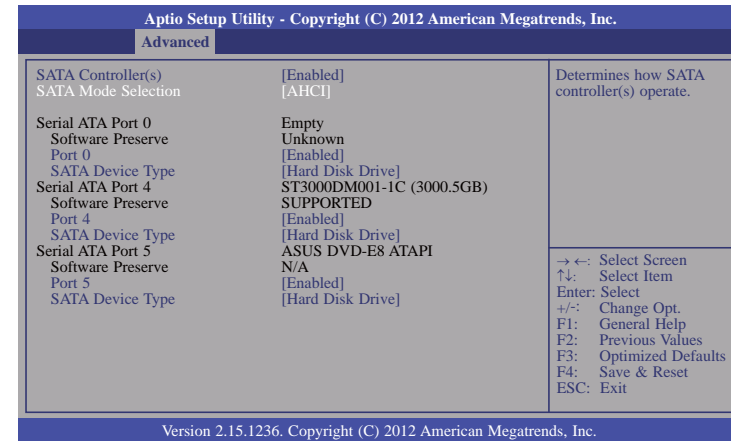

Port 0, Port 4 and Port 5

Enables or disables the SATA port.

SATA Device Type

Identifies the SATA port connected to Solid State Drive or Hard Disk Drive.

Intel(R) Rapid Start Technology

This section is used to enable or disable the Intel Rapid Start Technology.

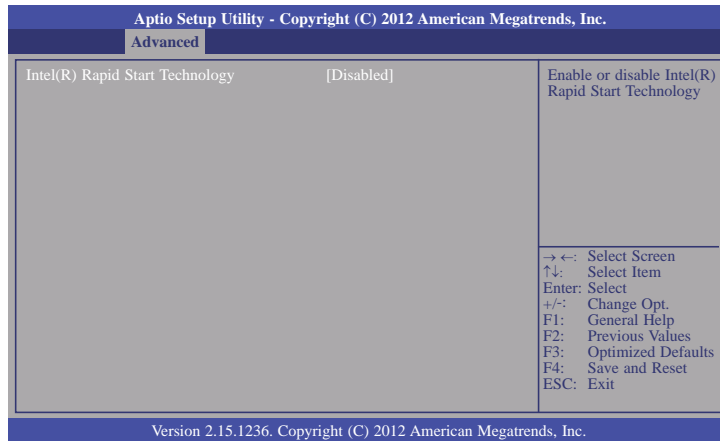

AMT Configuration

This section configures the parameters of Active Management Technology.

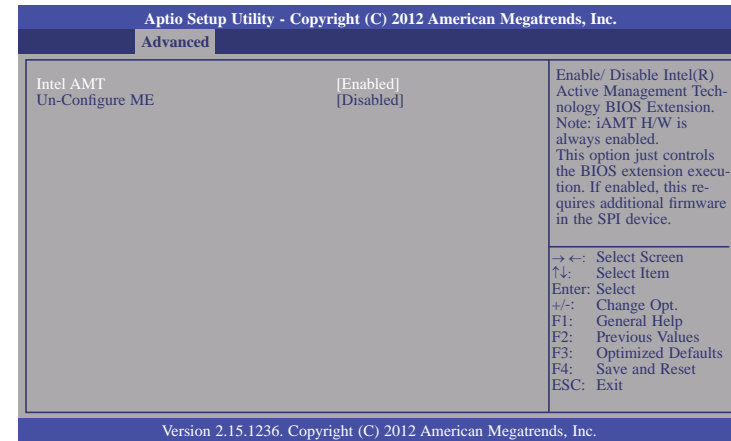

Intel AMT

Enables or disables the AMT function.

Un-Configure ME

Selects Enabled to un-configure the ME function without a password.

USB Configuration

This section is used to configure the parameters of USB device.

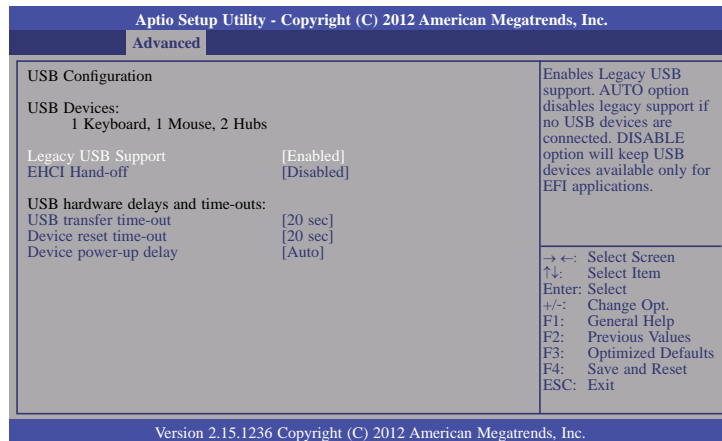

Legacy USB Support

Enabled

Enables legacy USB.

Auto

Disables support for legacy when no USB devices are connected.

Disabled

Keeps USB devices available only for EFI applications.

EHCI Hand-off

This is a workaround for OSEs that does not support EHCI hand-off. The EHCI ownership change should be claimed by the EHCI driver.

USB transfer time-out

The time-out value for Control, Bulk and Interrupt transfers.

Device reset time-out

Selects the USB mass storage device to start unit the commanded time-out.

Device power-up delay

Maximum time the device will take before it properly reports itself to the Host Controller. "Auto" uses default value: it is 100 ms for a Root port, and for a Hub port the delay is taken from the Hub descriptor.

PCH-FW Configuration

This section displays parameters of the Management Engine Technology.

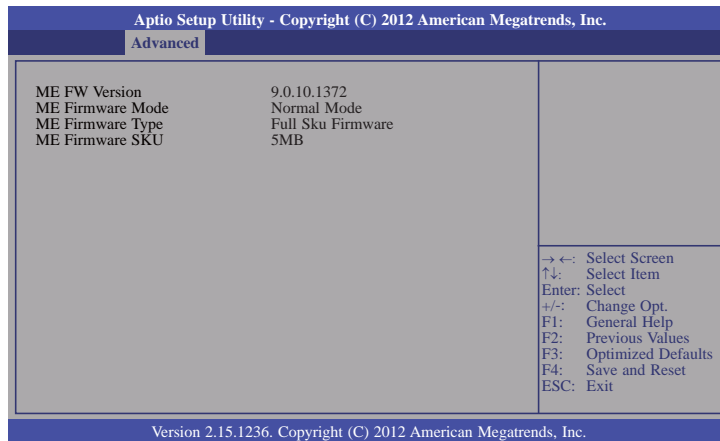

NCT6102D Super IO Configuration

This section is used to configure parameters of the system super IO chip.

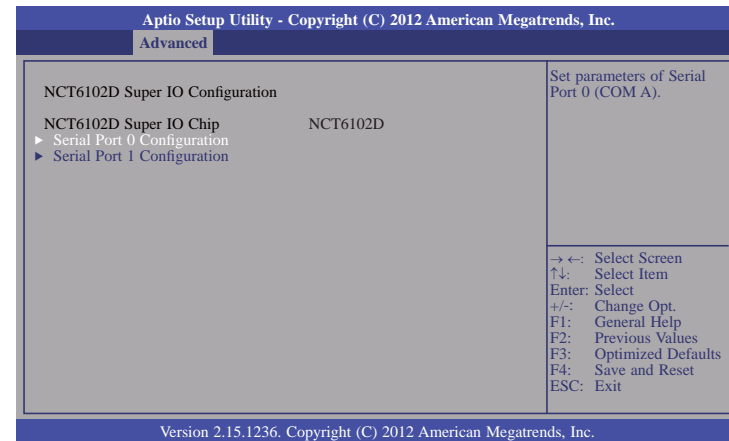

Serial Port 0 Configuration to Serial Port 1 Configuration

Sets the parameters of serial port 0 (COM A) and serial port 1 (COM B).

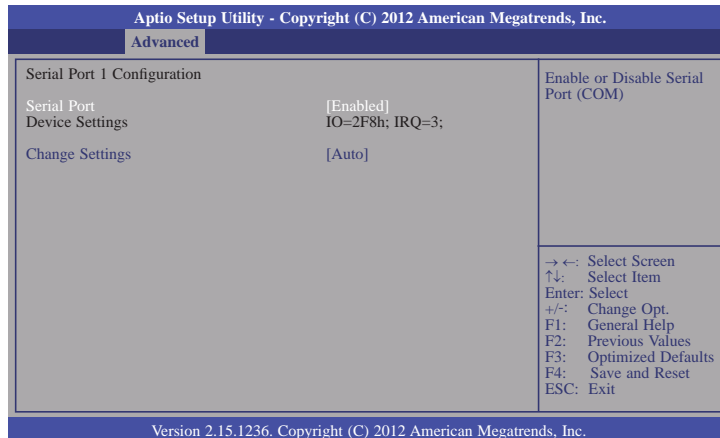
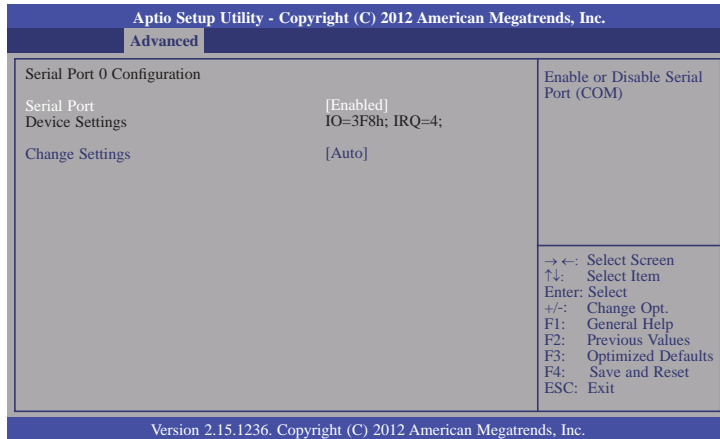

Serial Port

Enables or disables the serial port (COM).

Change Settings

Selects the IO/IRQ settings for the super I/O device.

NCT6102D Super IO HW Monitor

This section displays the hardware health monitor.

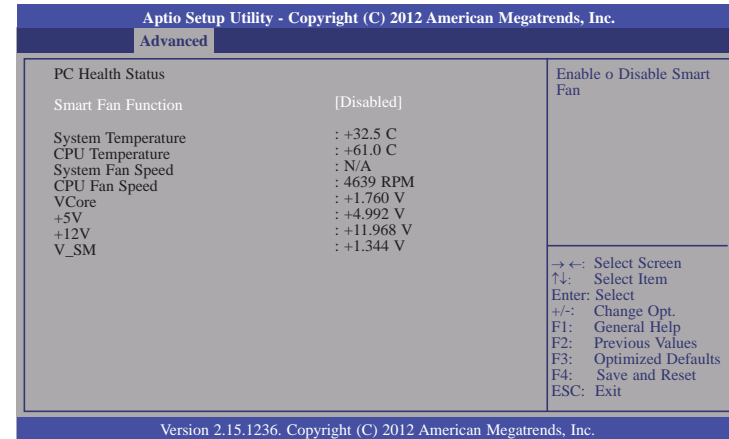

Smart Fan Function

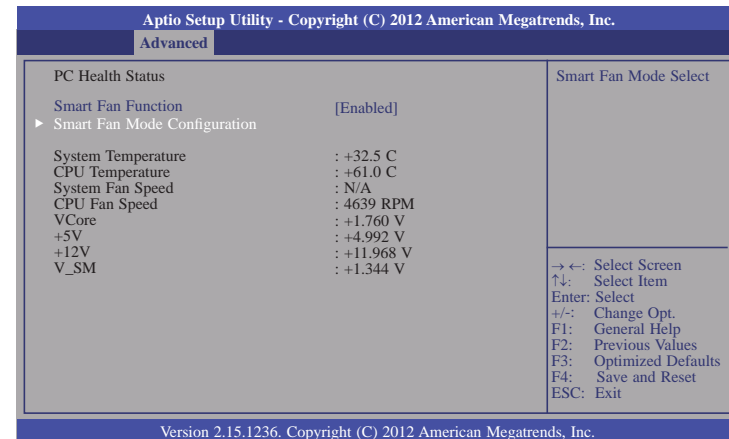

Smart Fan Mode Configuration

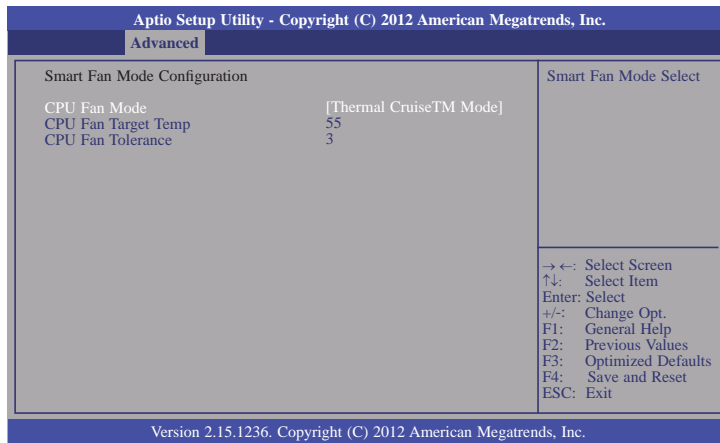

CPU Fan Mode

Selects the CPU Fan Mode.

CPU Fan Target Temp

The CPU's target temperature will vary according to the CPU Fan Mode.

CPU Fan Tolerance

The tolerance value of the CPU's temperature will vary according to the CPU Fan Mode.

NCT6102D Super IO Features

This section configures the support of some control functions.

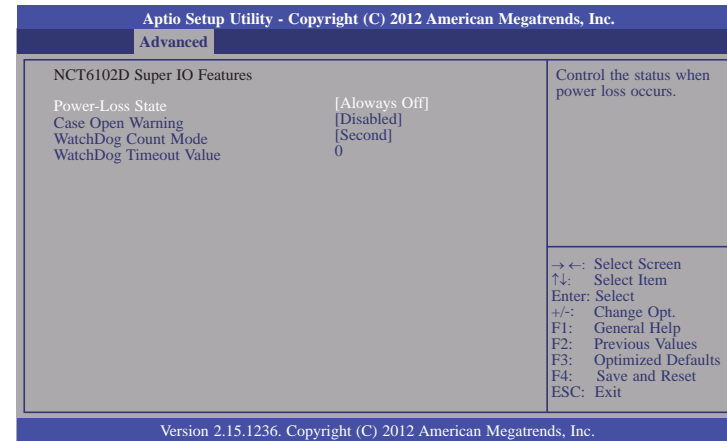

Power-Loss State

Controls the status when the power loss occurs.

Always Off

When power returns after an AC power failure, the system's power is off. You must press the Power button to power-on the system.

Always On

When power returns after an AC power failure, the system will automatically power-on.

Keep Last State

When power returns after an AC power failure, the system will return to the state where you left off before power failure occurs. If the system's power is off when AC power failure occurs, it will remain off when power returns. If the system's power is on when AC power failure occurs, the system will power-on when power returns.

Case Open Warning

Enables or disables case open warning function.

WatchDog Count Mode

Selects the watchdog count mode: second or minute.

WatchDog Timeout Value

Sets the timeout value of the super IO watchdog timer. 0 means disabled.

Network Stack

This section is used to enable or disable network stack settings.

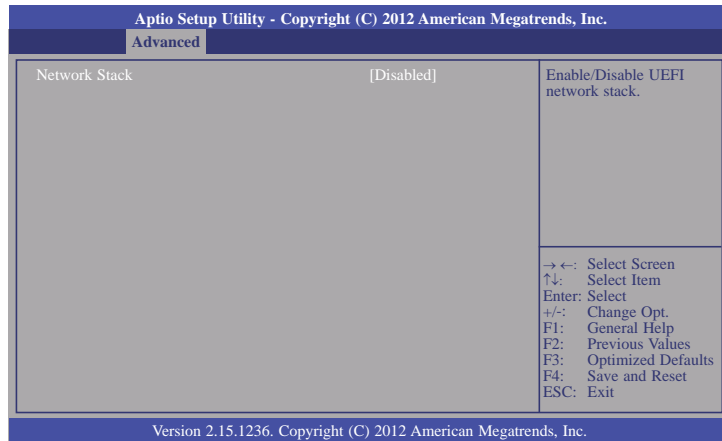

When Network Stack is enabled, it will display the following information:

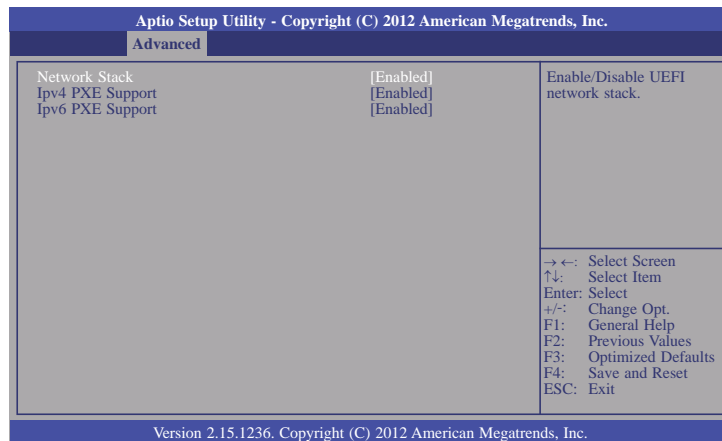

Ipv4 PXE Support

When enabled, Ipv4 PXE boot supports. When disabled, Ipv4 PXE boot option will not be created.

Ipv6 PXE Support

When enabled, Ipv6 PXE boot supports. When disabled, Ipv6 PXE boot option will not be created.

Intel(R) Ethernet Network Connection i217-LM - 88:88:88:...

This section is used to configure the parameters of the Gigabit Ethernet device.

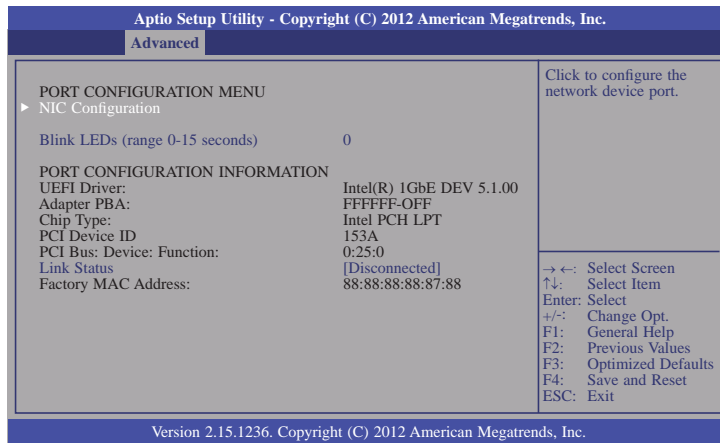

NIC Configuration

This field is used to configure the network device.

Blink LEDs

Blink LEDs for the specified duration (up to 15 seconds).

Link Status

This field indicates the link status of the network device.

Chipset

This section configures relevant chipset functions.

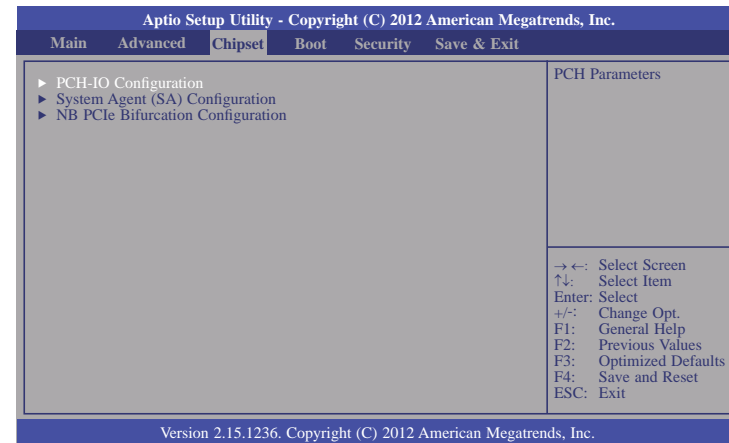

PCH-IO Configuration

This section illustrates the PCH parameters.

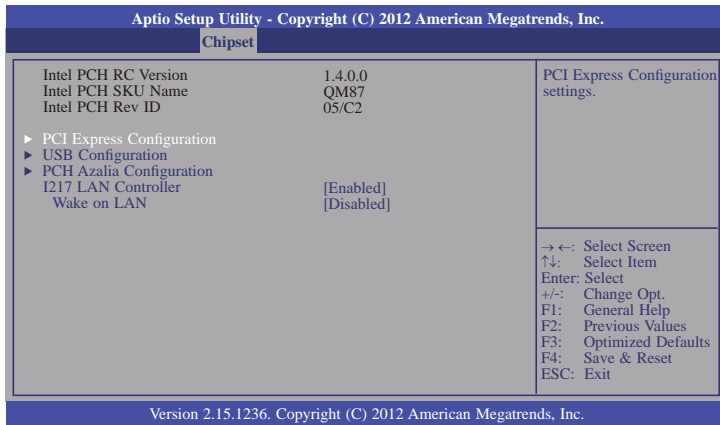

I217 LAN Controller

Enables or disables the onboard I217 LAN controller.

Wake on LAN

Enables or disables the integrated LAN to wake the system. (The Wake on LAN cannot be disabled if ME is on at Six state).

PCI Express Configuration

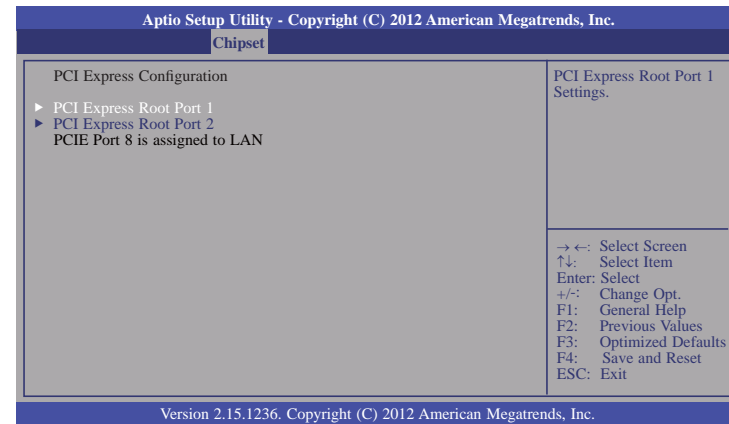

PCI Express Root Port 1 to PCI Express Root Port 2

Controls the PCI Express Root Port settings.

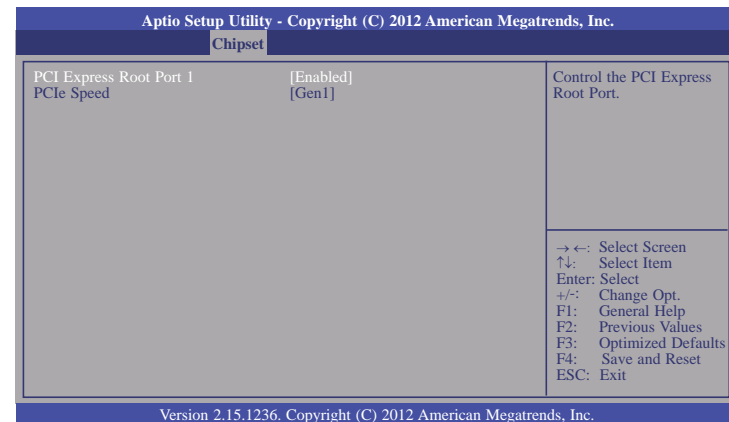

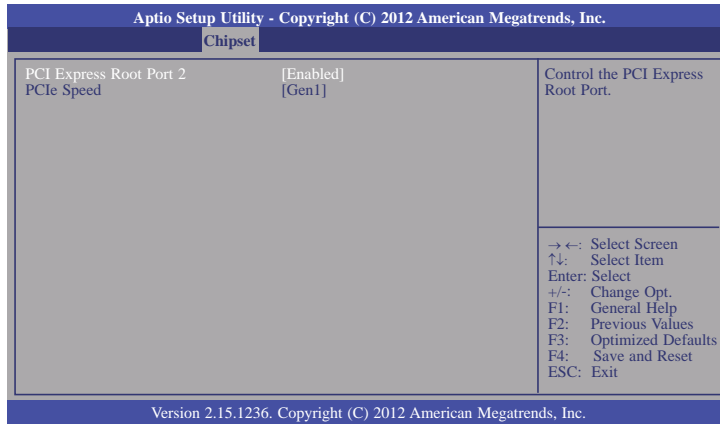

PCIe Speed

Selects the PCIe Speed: Gen1 or Gen 2.

USB Configuration

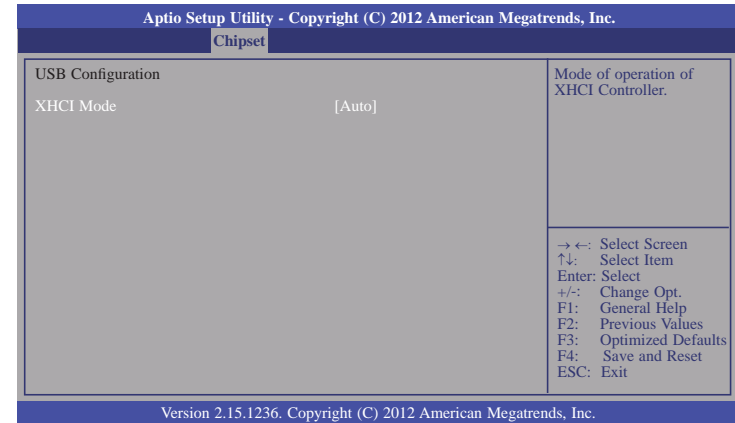

XHCI Mode

Selects the operation mode of XHCI controller. The options are Smart Auto, Auto, Enabled, Disabled and Manual.

When Disabled mode is selected, it will display the following information:

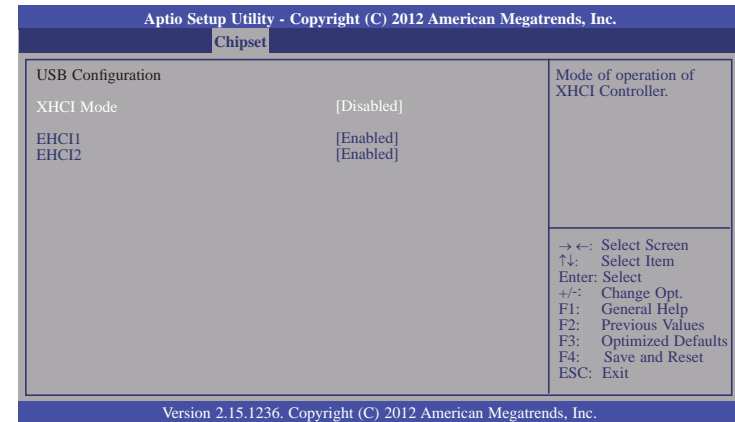

EHCI 1 and EHCI 2

These fields are used to control the functions of USB EHCI (USB 2.0) controllers. One EHCI controller must always be enabled.

When Manual mode is selected, it will display the following information:

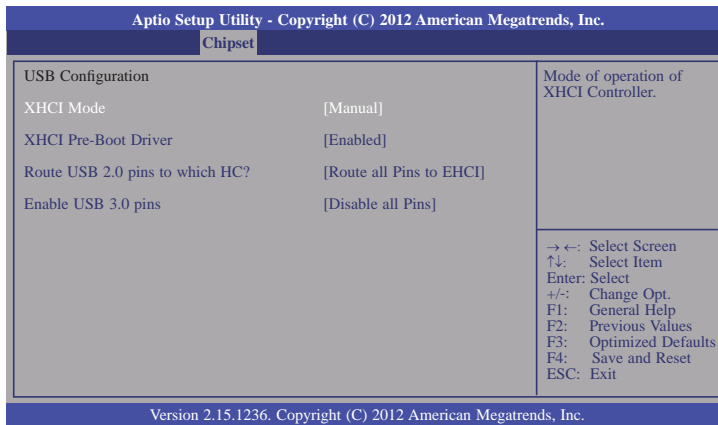

XHCI Pre-Boot Driver

Enables or disables the support of XHCI pre-boot driver.

Route USB 2.0 pins to which HC?

Routes USB 2.0 pins to EHCI or XHCI.

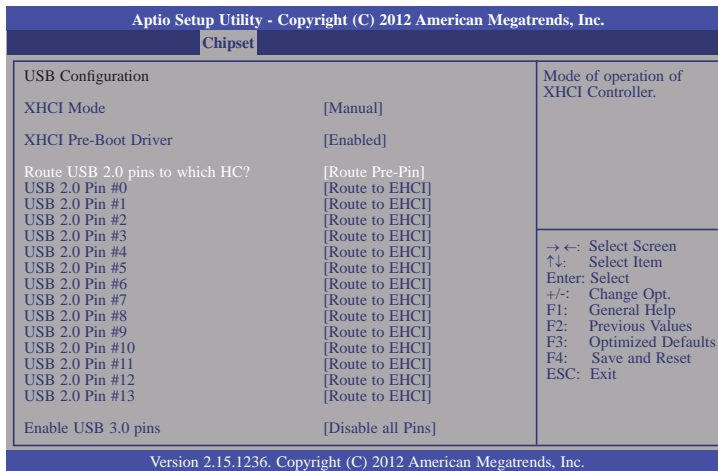

Enable USB 3.0 pins

Enables or disables the support of XHCI superspeed.

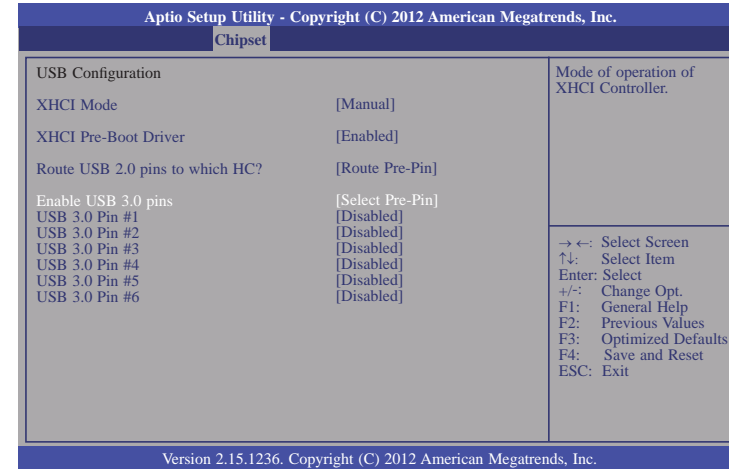

PCH Azalia Configuration

This field is used to configure the PCH Azalia settings.

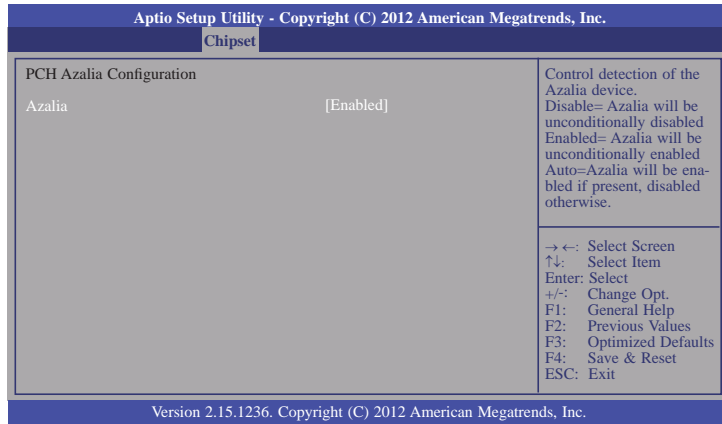

System Agent (SA) Configuration

This section is used to configure the parameters of System Agent.

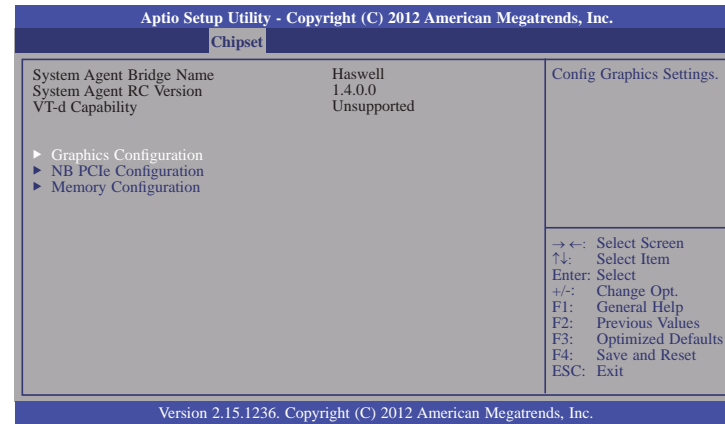

Graphics Configuration

This field configures the graphics settings.

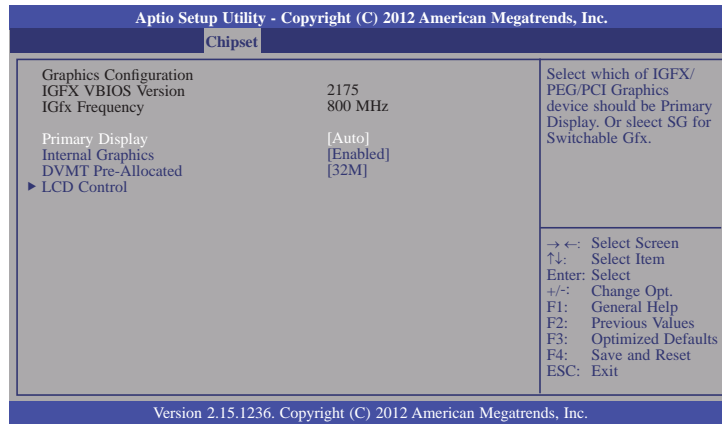

Primary Display

Auto When the system boots, it will auto detects the display device.

IGFX When the system boots, it will first initialize the onboard VGA.

PEG When the system boots, it will first initialize the PCI Express x16 graphics card.

Internal Graphics

Keeps IGD enabled based on the setup options.

DVMT Pre-Allocated

Selects DVMT 5.0 Pre-Allocated (Fixed) Graphics Memory size used by the Internal Graphics Device. Please refer to the screen shown below.

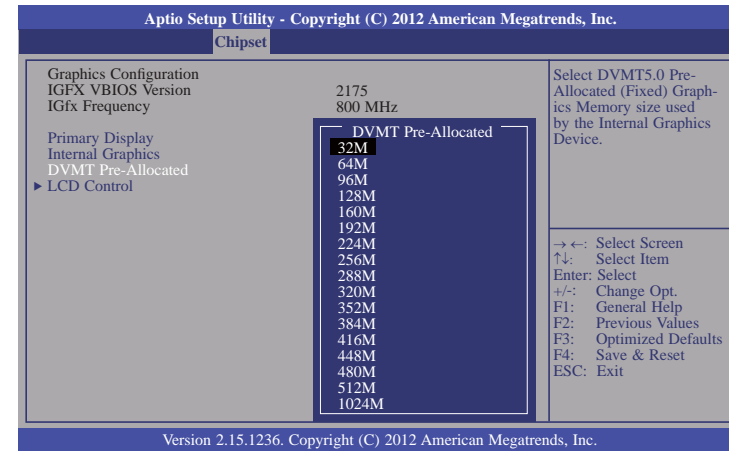

LCD Control

This field configures the LCD control.

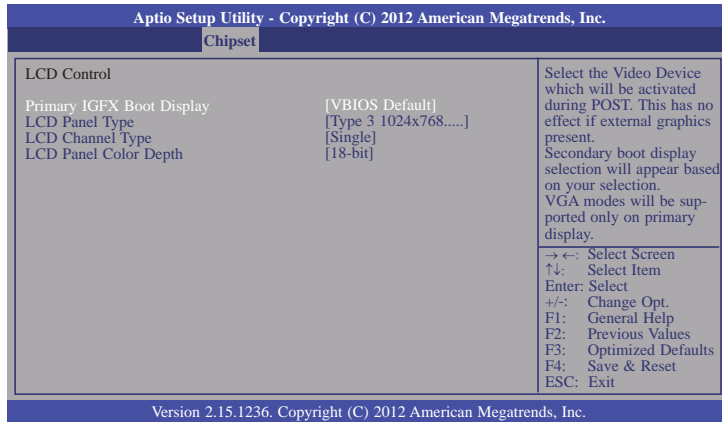

When any device is selected in the Primary IGFX Boot Display, it will display the following information:

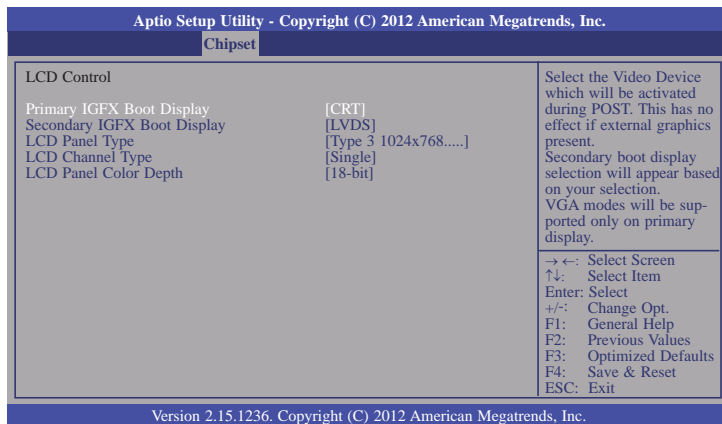

Secondary IGFX Boot Display

Selects secondary display device.

LCD Panel Type

Selects LCD panel used by Internal Graphics Device by selecting the appropriate setup item.

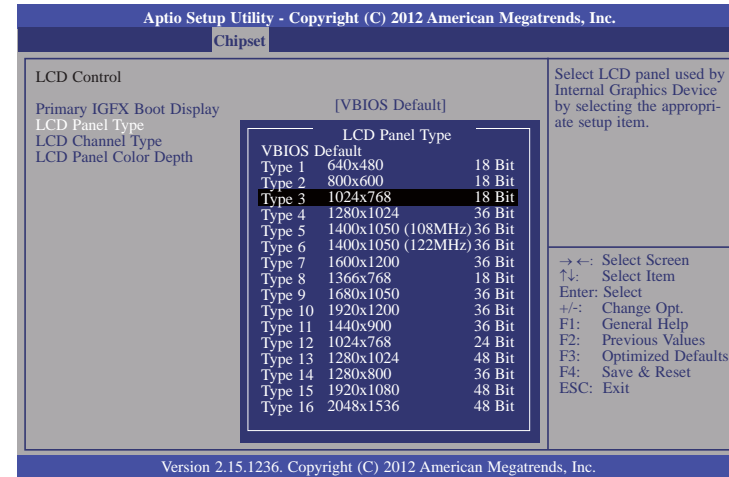

LCD Channel Type

Select the LCD Channel Type. The option is dual or single.

LCD Panel Color Depth

Select the color mode of the LCD display. The option is 24-bit or 18-bit.

NB PCIe Configuration

This field is used to configure the settings of NB PCI Express.

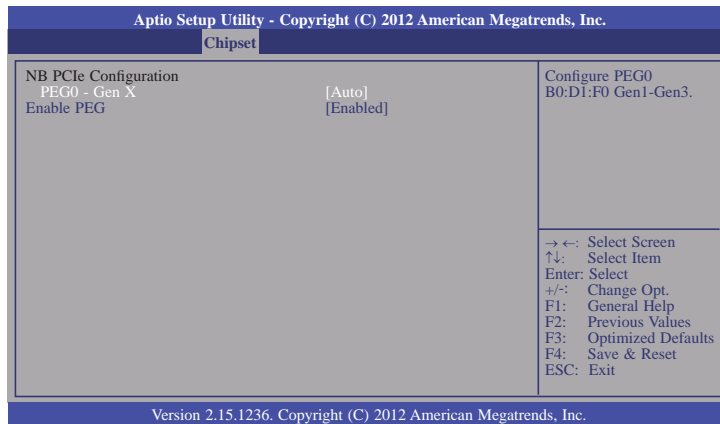

PEG0-Gen X

Configure PEG0 Gen1-Gen3.

Enable PEG

Enable or disable the PEG.

Memory Configuration

This field only displays the memory configuration.

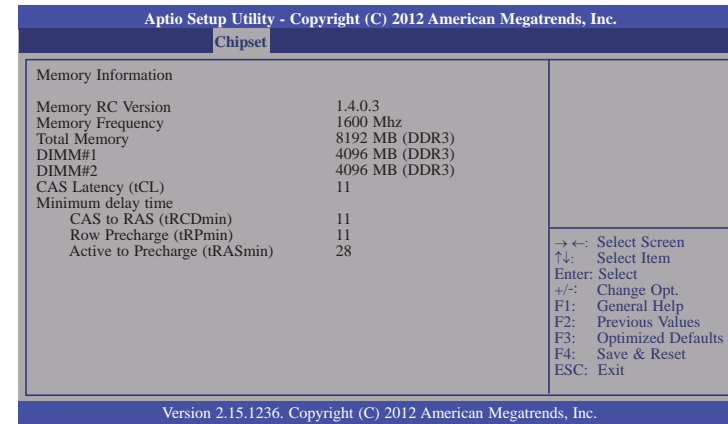

NB PCIe Bifurcation Configuration

This field is used to configure the parameters of CPU PEG Bifurcation.

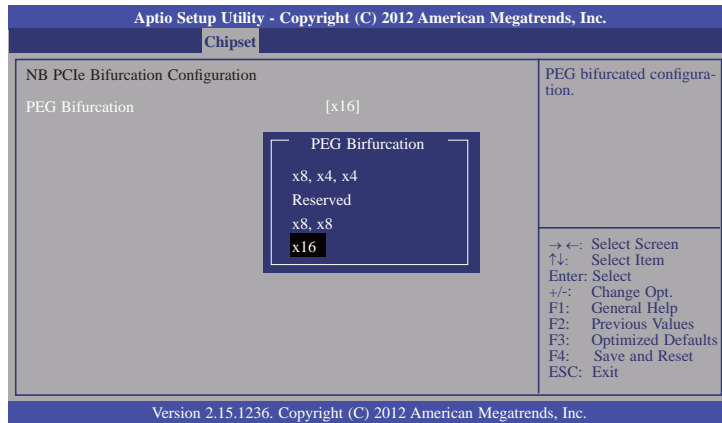

Boot

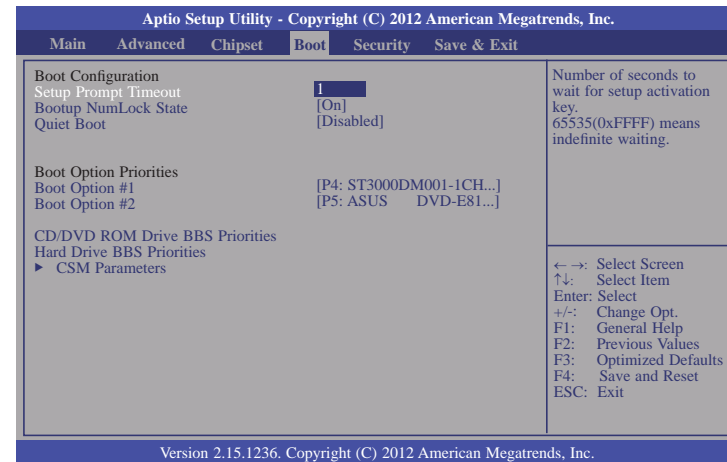

Setup Prompt Timeout

Selects the number of seconds to wait for the setup activation key. 65535(0xFFFF) denotes indefinite waiting.

Bootup NumLock State

This allows you to determine the default state of the numeric keypad. By default, the system boots up with NumLock on wherein the function of the numeric keypad is the number keys. When set to Off, the function of the numeric keypad is the arrow keys.

Quiet Boot

Enables or disables the quiet boot function.

Boot Option #1/#2

Sets the order of the system boot.

CD/DVD ROM Drive BBS Priorities

Sets the order of the legacy devices in this group.

Hard Driver BBS Priorities

Set the order of the legacy devices in this group.

CSM Parameters

Aptio Setup Utility - Copyright (C) 2012 American Megatrends, Inc.					
Main	Advanced	Chipset	Boot	Security	Save & Exit
Launch PXE OpROM policy				[Do not launch]	
Launch Storage OpROM policy				[Legacy only]	
Controls the execution of UEFI and Legacy PXE OpROM.					
→ ←: Select Screen ↑↓: Select Item Enter: Select +/-: Change Opt. F1: General Help F2: Previous Values F3: Optimized Defaults F4: Save & Reset ESC: Exit					
Version 2.15.1236. Copyright (C) 2012 American Megatrends, Inc.					

Launch PXE OpROM policy

Control the execution of UEFI and legacy PXE OpROM.

Launch Storage OpROM policy

Control the execution of UEFI and legacy storage OpROM.

Security

Aptio Setup Utility - Copyright (C) 2012 American Megatrends, Inc.					
Main	Advanced	Chipset	Boot	Security	Save & Exit
Password Description					Set Administrator Password.
If ONLY the Administrator's password is set, then this only limits access to Setup and is only asked for when entering Setup. If ONLY the User's password is set, then this is a power on password and must be entered to boot or enter Setup. In Setup the User will have Administrator rights. The password length must be in the following range: Minimum length 3 Maximum length 20					
Administrator Password					
User Password					
→ ←: Select Screen ↑↓: Select Item Enter: Select +/-: Change Opt. F1: General Help F2: Previous Values F3: Optimized Defaults F4: Save & Reset ESC: Exit					
Version 2.15.1236. Copyright (C) 2012 American Megatrends, Inc.					

Administrator Password

Sets the administrator password.

User Password

Sets the user password.

Save & Exit

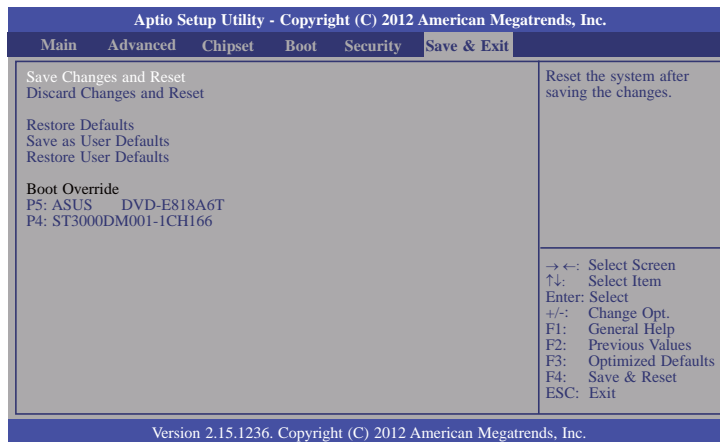

Save Changes and Reset

To save the changes, select this field and then press <Enter>. A dialog box will appear. Select Yes to reset the system after saving all changes made.

Discard Changes and Reset

To discard the changes, select this field and then press <Enter>. A dialog box will appear. Select Yes to reset the system setup without saving any changes.

Restore Defaults

To restore and load the optimized default values, select this field and then press <Enter>. A dialog box will appear. Select Yes to restore the default values of all the setup options.

Save as User Defaults

To save changes done so far as user default, select this field and then press <Enter>. A dialog box will appear. Select Yes to save values as user default.

Restore User Defaults

To restore user default to all the setup options, select this field and then press <Enter>. A dialog box will appear. Select Yes to restore user default.

Updating the BIOS

To update the BIOS, you will need the new BIOS file and a flash utility, AFUDOS.EXE. Please contact technical support or your sales representative for the files.

To execute the utility, type:

```
A:> AFUDOS BIOS_File_Name /b /p /n
```

then press <Enter>.

```
C:\AFU\AFUDOS>afudos filename /B /P /N
AMI Firmware Update Utility(APTIO) v2.25
Copyright (C)2008 American Megatrends Inc. All Rights Reserved.
Reading file ..... done
Erasing flash ..... done
Writing flash ..... done
Verifying flash ..... done
Erasing BootBlock ..... done
Writing BootBlock ..... done
Verifying BootBlock ..... done
C:\AFU\AFUDOS>
```

Notice: BIOS SPI ROM

1. The Intel® Management Engine has already been integrated into this system board. Due to the safety concerns, the BIOS (SPI ROM) chip cannot be removed from this system board and used on another system board of the same model.
2. The BIOS (SPI ROM) on this system board must be the original equipment from the factory and cannot be used to replace one which has been utilized on other system boards.
3. If you do not follow the methods above, the Intel® Management Engine will not be updated and will cease to be effective.

**Note:**

- a. You can take advantage of flash tools to update the default configuration of the BIOS (SPI ROM) to the latest version anytime.
- b. When the BIOS IC needs to be replaced, you have to populate it properly onto the system board after the EEPROM programmer has been burned and follow the technical person's instructions to confirm that the MAC address should be burned or not.

Chapter 4 - Supported Software

Install drivers, utilities and software applications that are required to facilitate and enhance the performance of the system board. You may acquire the software from your sales representatives, from an optional DVD included in the shipment, or from the website download page at <https://www.dfi.com/DownloadCenter>.

For Windows 8

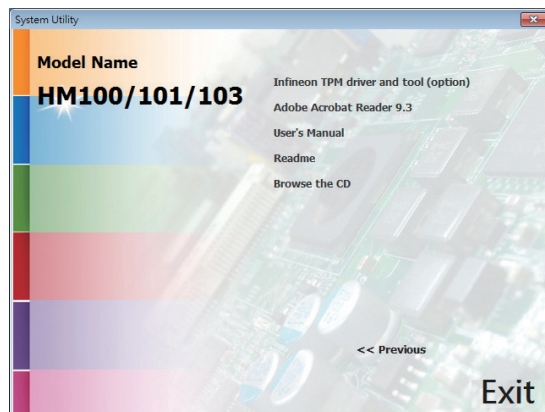
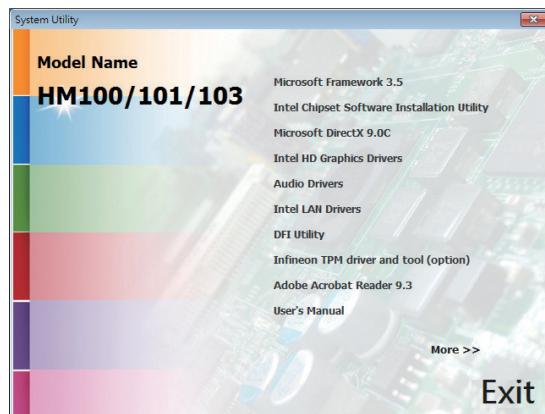

For Windows 7

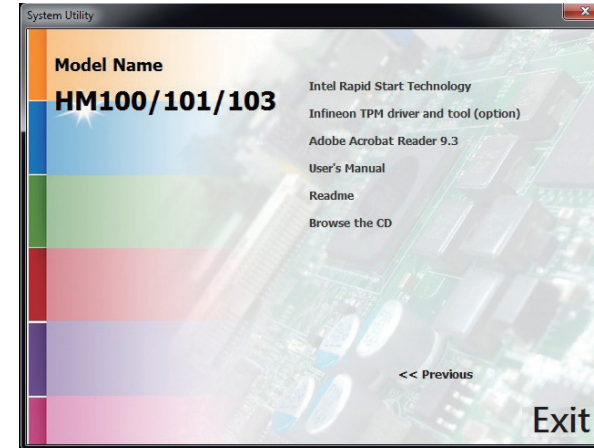

Note:

This step can be ignored if the applications are standalone files.

For Windows XP

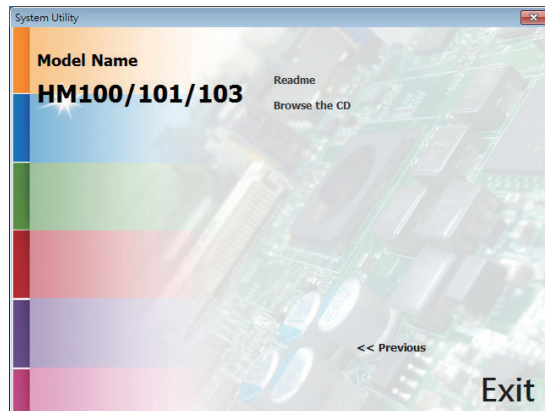
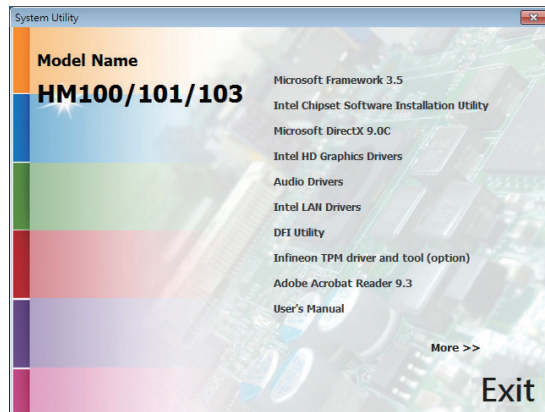

Microsoft .NET Framework 3.5 (For Windows 8 and Windows XP)

**Note:**

Before installing Microsoft .NET Framework 3.5, make sure you have updated your Windows XP operating system to Service Pack 3.

To install the driver, click "Microsoft .NET Framework 3.5" on the main menu.

1. Read the license agreement carefully.

Click "I have read and accept the terms of the License Agreement" then click Install.

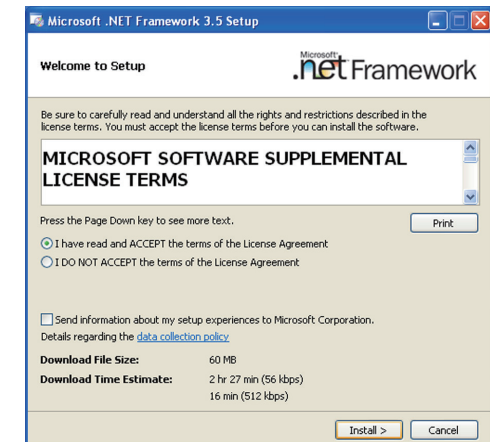

2. Setup is now installing the driver.

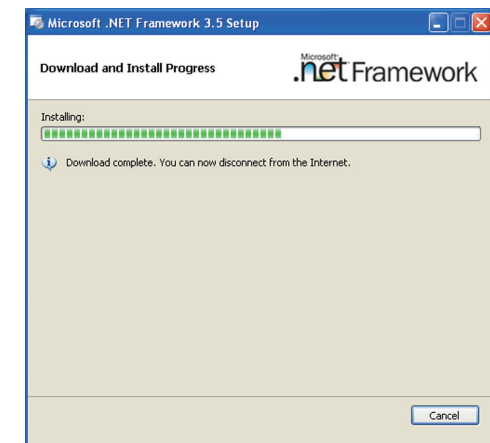

3. Click Exit.

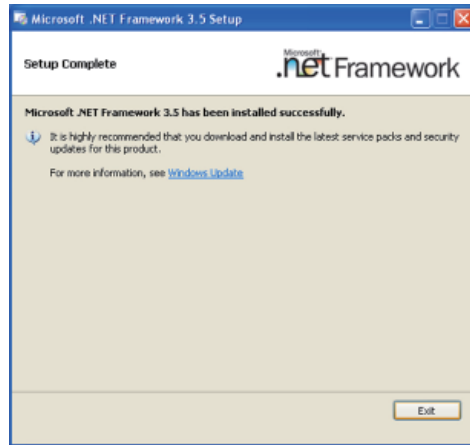

Intel Chipset Software Installation Utility

The Intel Chipset Software Installation Utility is used for updating Windows® INF files so that the Intel chipset can be recognized and configured properly in the system.

To install the utility, click "Intel Chipset Software Installation Utility" on the main menu.

1. Setup is ready to install the utility. Click Next.



2. Read the license agreement then click Yes.



- Go through the readme document for more installation tips then click Next.



- Click Finish to exit setup.



Microsoft DirectX 9.0C (For Windows 8 and Windows XP)

To install the utility, click “Microsoft DirectX 9.0C Driver” on the main menu.

- Click “I accept the agreement” then click Next.

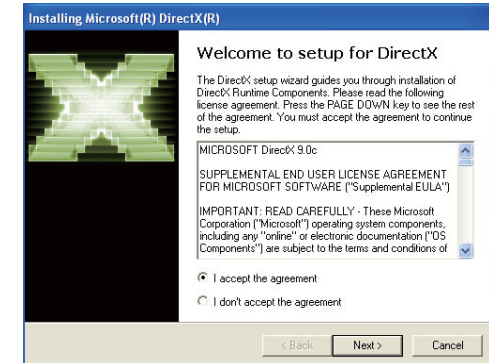

- To start installation, click Next.

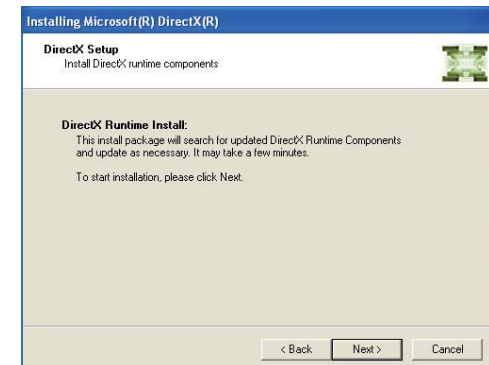

- Click Finish. Reboot the system for DirectX to take effect.

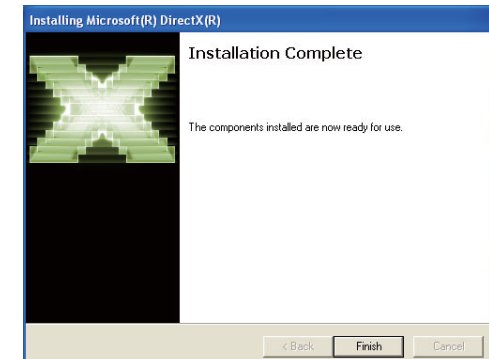

Intel HD Graphics Drivers (For Windows 7 and Windows 8)

To install the driver, click “Intel HD Graphics Drivers” on the main menu.

1. Setup is now ready to install the graphics driver. Click Next.



By default, the “Automatically run WinSAT and enable the Windows Aero desktop theme” is enabled. With this enabled, after installing the graphics driver and the system rebooted, the screen will turn blank for 1 to 2 minutes (while WinSAT is running) before the Windows Vista desktop appears. The “blank screen” period is the time Windows is testing the graphics performance.

2. Read the license agreement then click Yes.

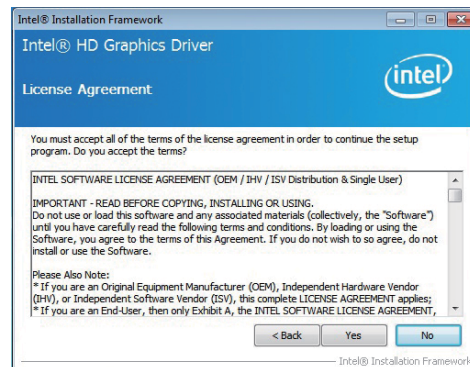

3. Go through the readme document for system requirements and installation tips then click Next.

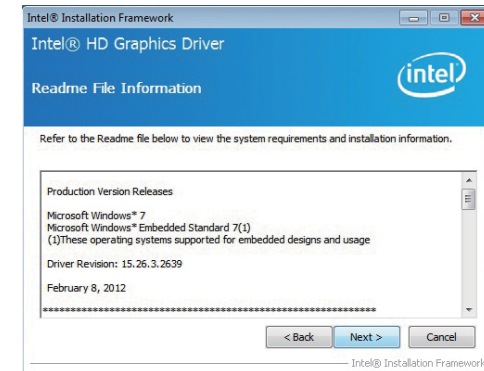

4. Setup is now installing the driver. Click Next to continue.

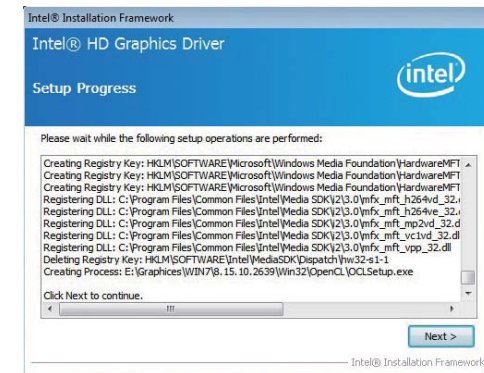

5. Click “Yes, I want to restart this computer now” then click Finish.

Restarting the system will allow the new software installation to take effect.

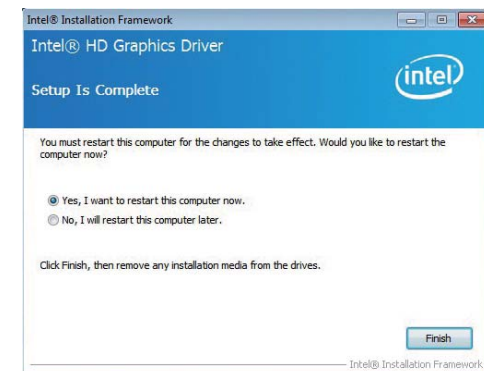

Intel HD Graphics Drivers (For Windows XP)

To install the driver, click “Intel HD Graphics Drivers” on the main menu.

1. To start installation, click Next.



2. Read the license agreement then click Yes.

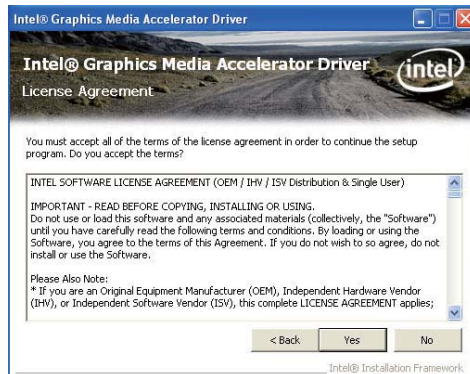

3. Go through the readme document for system requirements and installation tips then click Next.

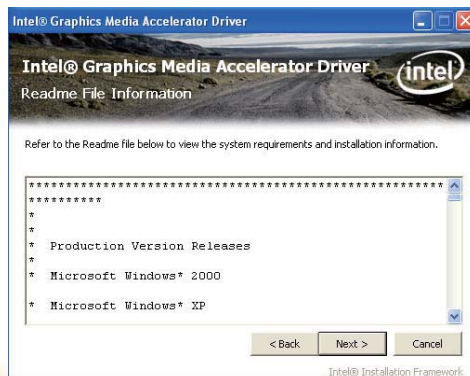

4. Setup is now installing the driver. Click Next to continue.

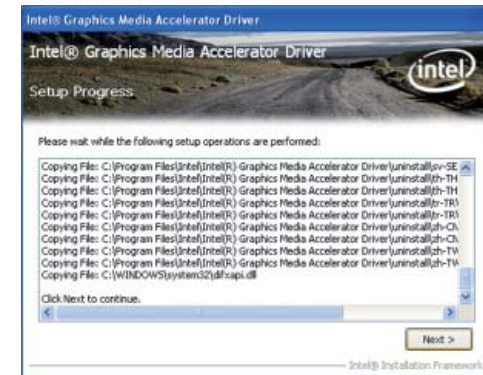

5. Click “Yes, I want to restart this computer now” then click Finish.

Restarting the system will allow the new software installation to take effect.

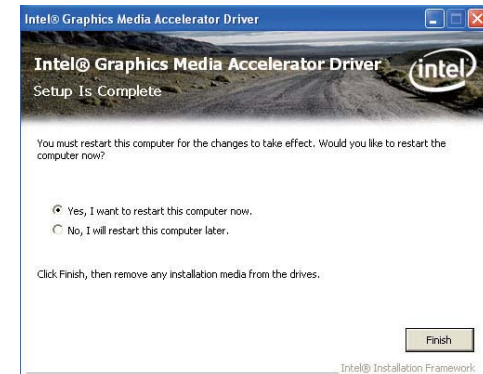

Audio Drivers

To install the driver, click “Audio Drivers” on the main menu.

1. Setup is ready to install the driver. Click Next.

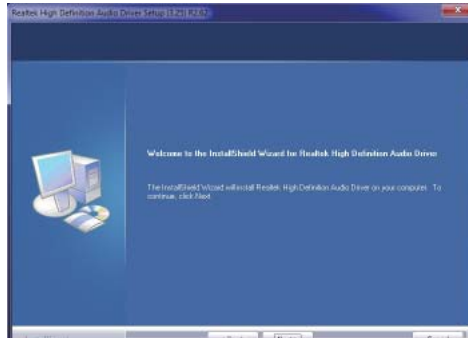

2. Click “Yes, I want to restart my computer now” then click Finish.

Restarting the system will allow the new software installation to take effect.

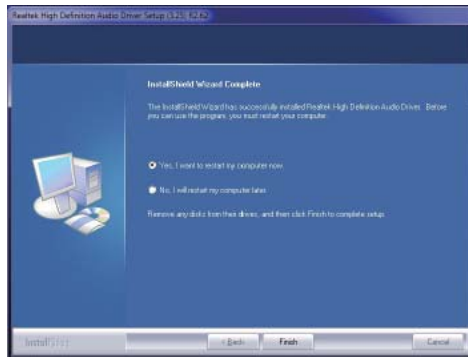

Intel LAN Drivers (For Windows 7 and Windows 8)

To install the driver, click “Intel LAN Drivers” on the main menu.

1. Setup is ready to install the driver. Click Next.

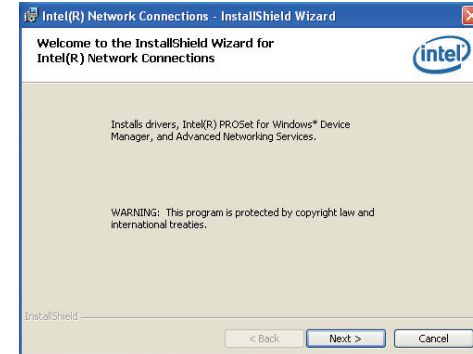

2. Click “I accept the terms in the license agreement” then click “Next”.

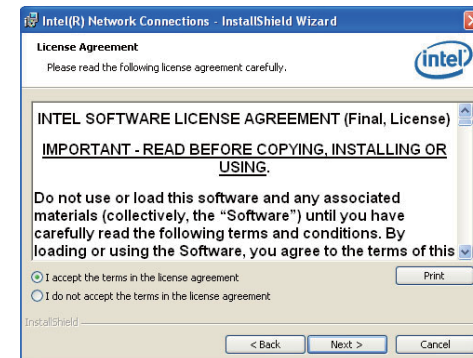

3. Select the program features you want installed then click Next.

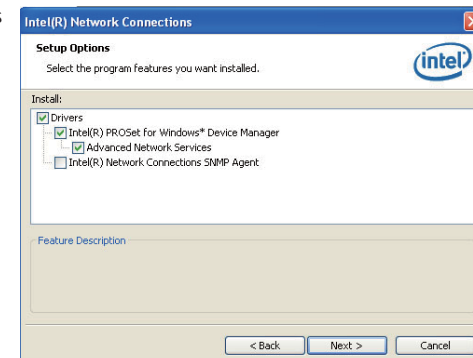

4. Click Install to begin the installation.

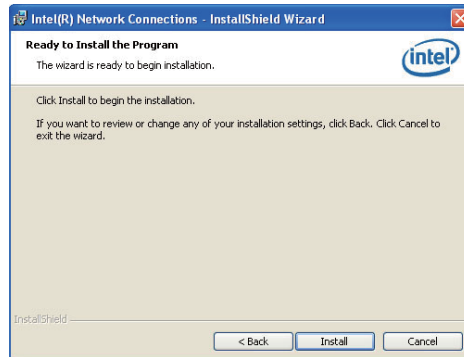

5. After completing installation, click Finish.

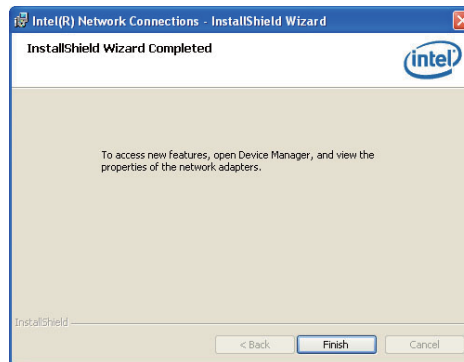

Intel LAN Drivers (For Windows XP)

The LAN drivers for Windows XP supporting on the HM101-QM87/HM86 system board has to be installed manually. When you want to install the LAN driver for Windows XP, please follow the steps below to accomplish the installation.

1. Launch the Hardware Update Wizard for the selected device. Select "Update Driver."

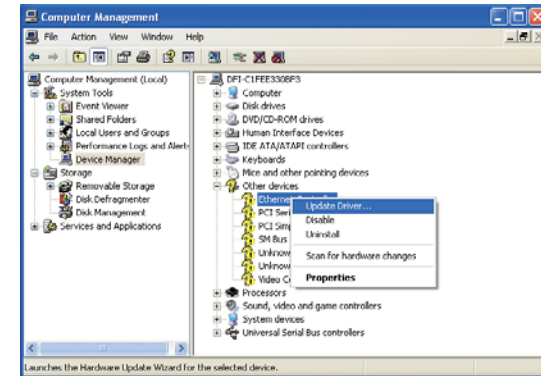

2. Choose "Install from a list or specific location (Advanced)" and click "Next" to continue the installation.

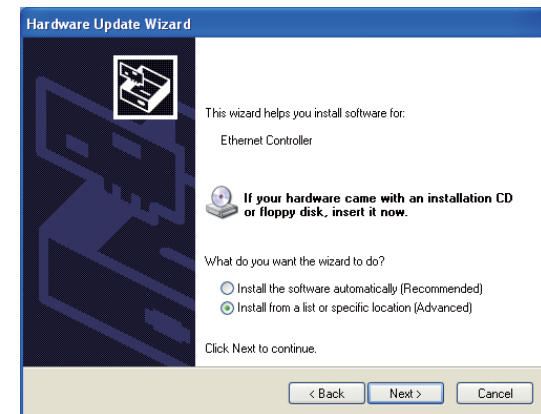

3. Choose the option "Don't search. I will choose the driver to install" in order to select the device driver from a list, and click "Next."

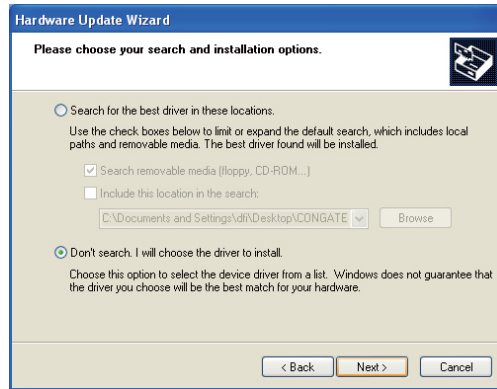

4. Select a hardware type: DVD/CD-ROM drives. Then, click "Next."

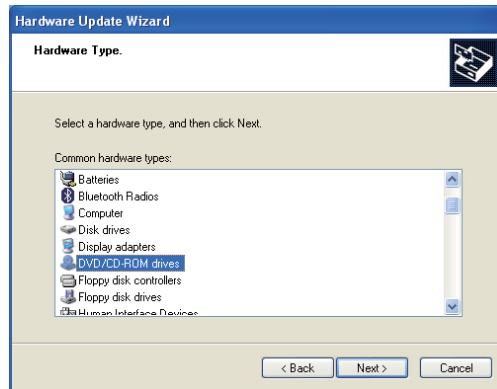

5. Select your hardware disk and then click "Have Disk..."

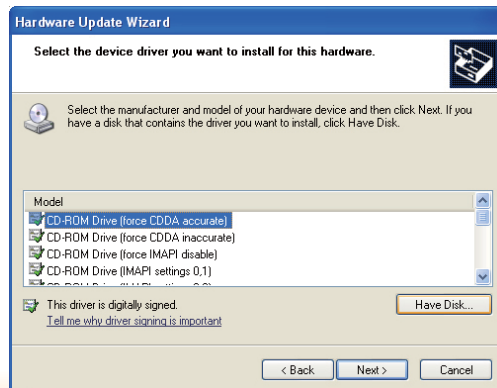

6. Insert the installation disk and make sure the selected drive is correct.



(For 32-bit, the file name is "e1d5132.inf".)

7. Select the device driver you want to install for this hardware and then click "Next."

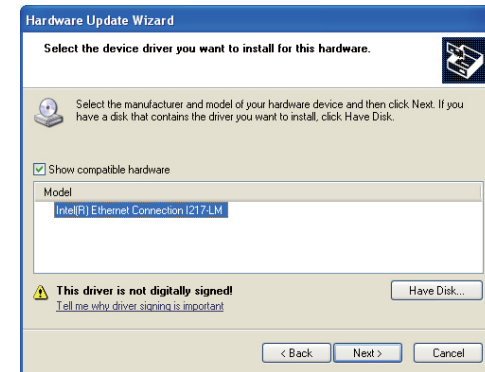

8. Check the software you are installing. Then, click "Continue Anyway" to start the installation.

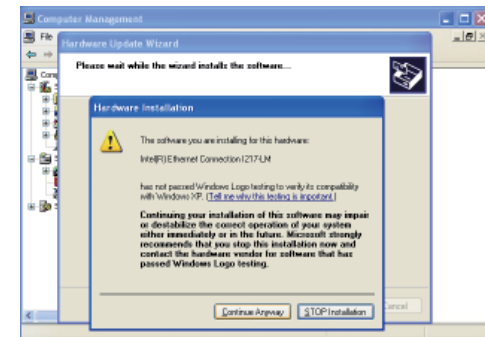

9. Click "Finish" to close the wizard.

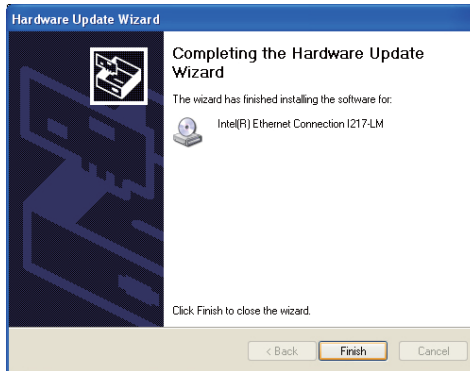

10. After completing the installation, the Network adapters "Intel(R) Ethernet Connection I217LM" will appear on the computer management list.

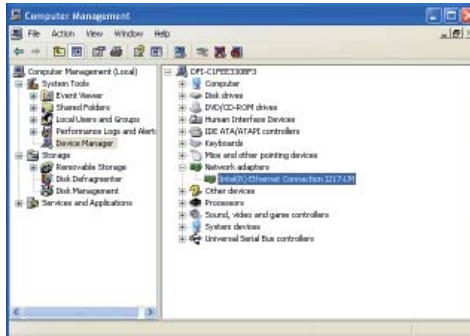

DFI Utility

DFI Utility provides information about the board, Watchdog, and DIO. To access the utility, click "DFI Utility" on the main menu.



Note:

If you are using Windows 7, you need to access the operating system as an administrator to be able to install the utility.

1. Setup is ready to install the DFI Utility driver. Click "Next".

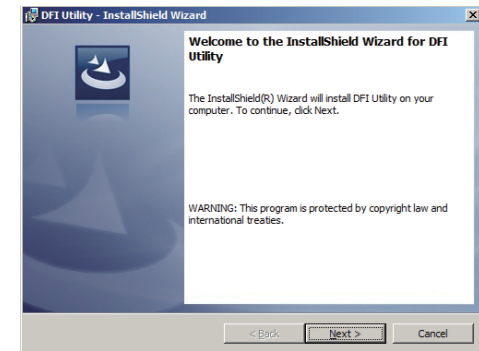

2. Click "I accept the terms in the license agreement" then click "Next".

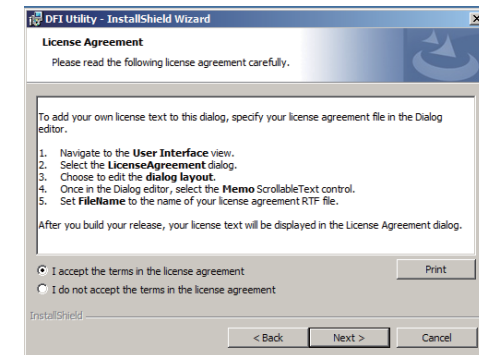

3. Enter "User name" (SB102) and "Organization" information then click "Next".

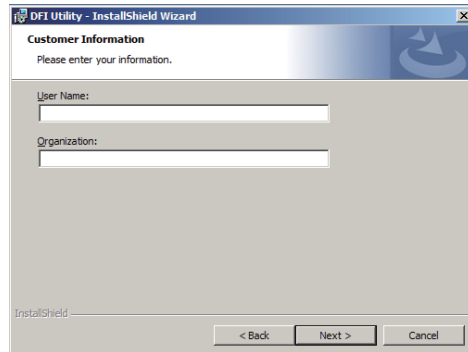

4. Click "Install" to begin the installation.

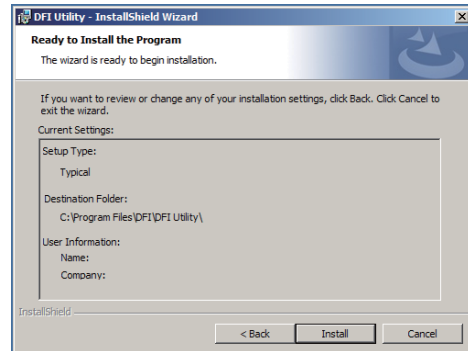

5. After completing installation, click "Finish".

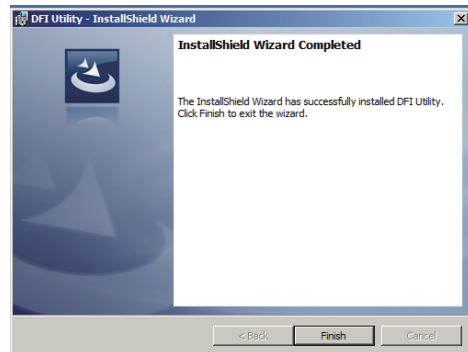

The DFI Utility icon will appear on the desktop. Double-click the icon to open the utility.

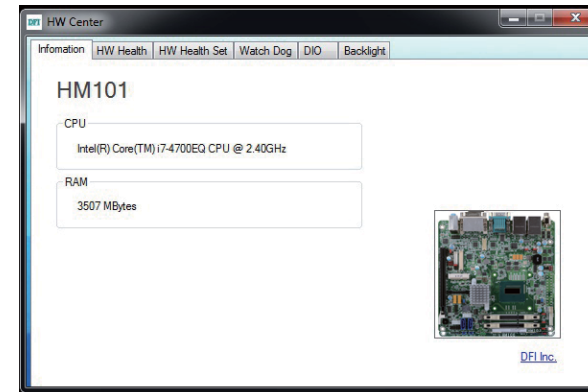

Information

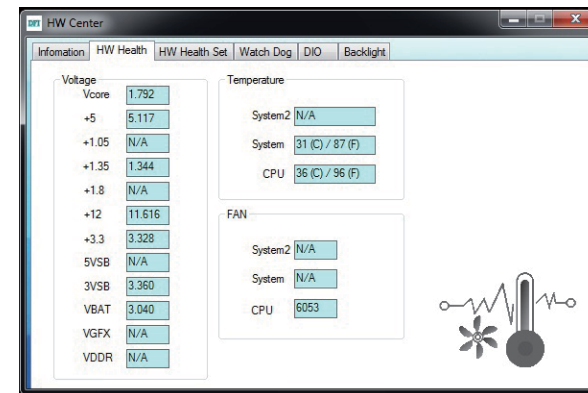

HW Health

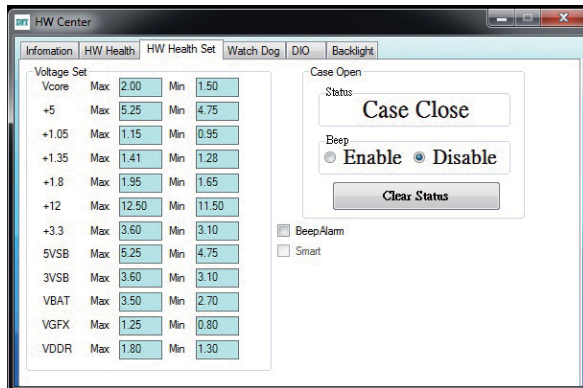

HW Health Set

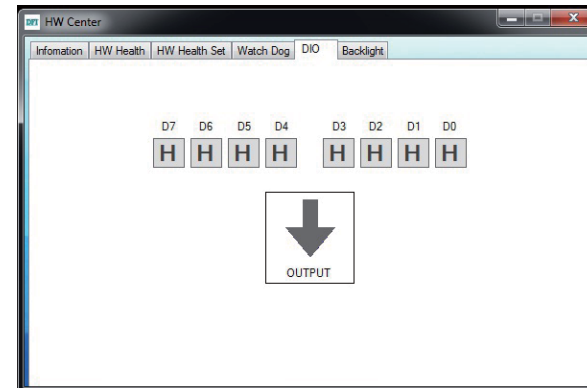

DIO

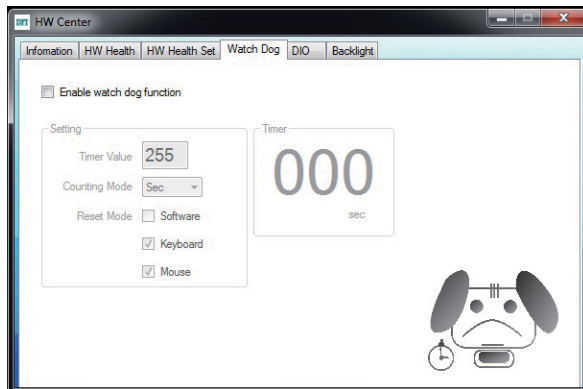

WatchDog

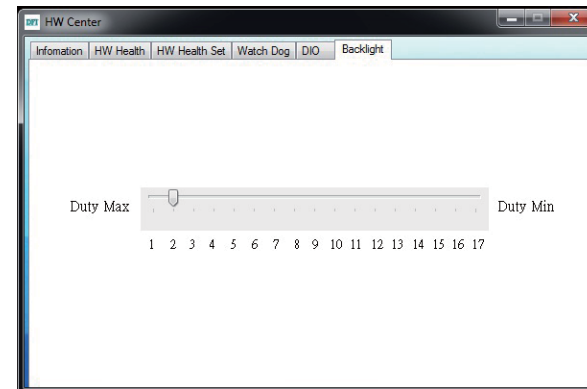

Backlight

Intel USB 3.0 Drivers (For Windows 7 Only)

To install the driver, click "Intel USB 3.0 Driver" on the main menu.

1. Setup is ready to install the driver. Click Next.

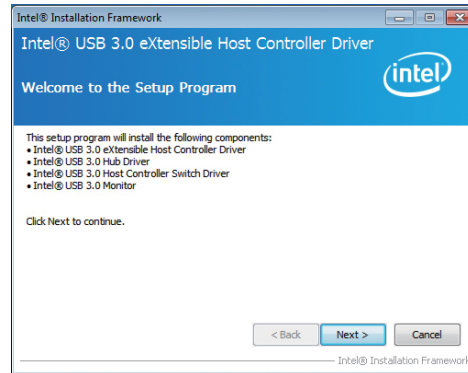

2. Read the license agreement then click Yes.



3. Go through the readme document for more installation tips then click Next.

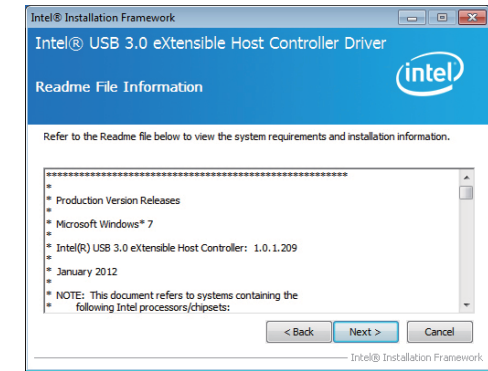

4. Setup is currently installing the driver. After installation has completed, click Next.

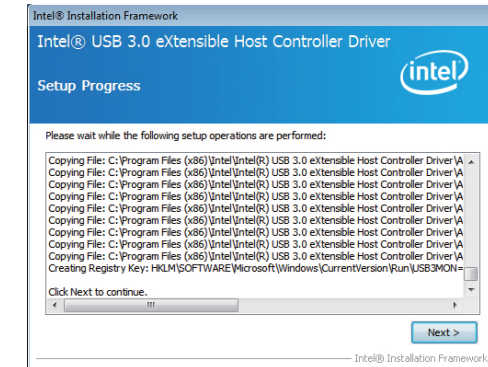

5. After completing installation, click Finish.



Intel Rapid Storage Technology (For Windows 7 Only)

The Intel Rapid Storage Technology is a utility that allows you to monitor the current status of the SATA drives. It enables enhanced performance and power management for the storage subsystem.

To install the driver, click "Intel Rapid Storage Technology" on the main menu.

1. Setup is now ready to install the utility. Click Next.

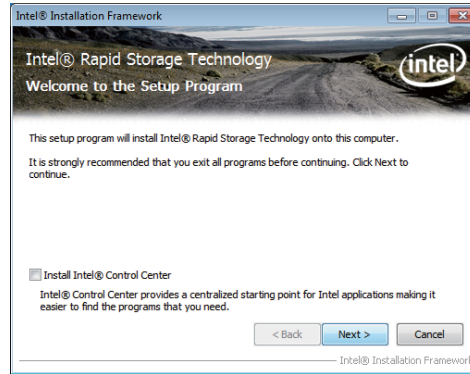

2. Read the warning then click Yes.

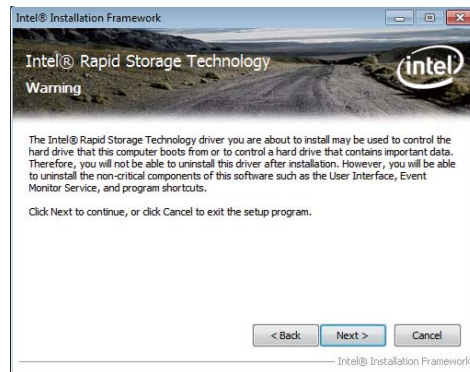

3. Read the license agreement then click Yes.

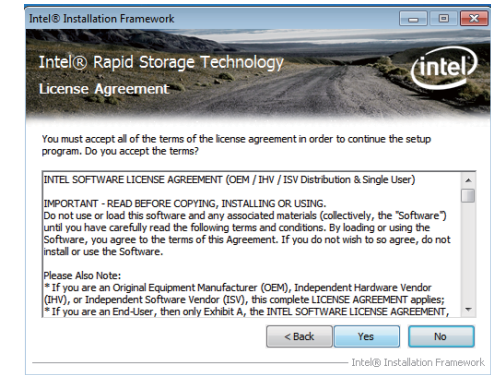

4. Go through the readme document for system requirements and installation tips then click Next.

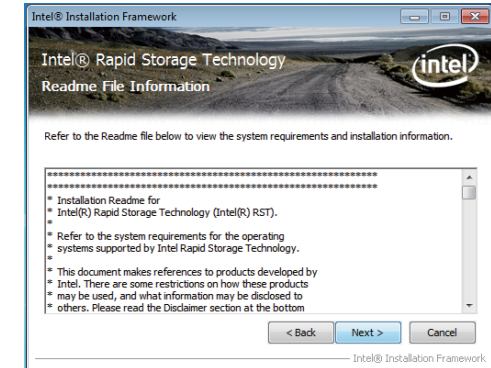

5. Setup is now installing the utility. Click Next to continue.

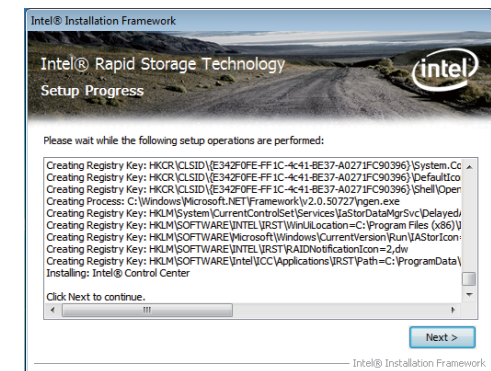

6. Click “Yes, I want to restart my computer now” then click Finish.

Restarting the system will allow the new software installation to take effect.



Intel Turbo Boost Drivers (For Windows 7 Only)

To install the driver, click “Intel Turbo Boost Monitor” on the main menu.

1. The setup program is configuring the new software installation.

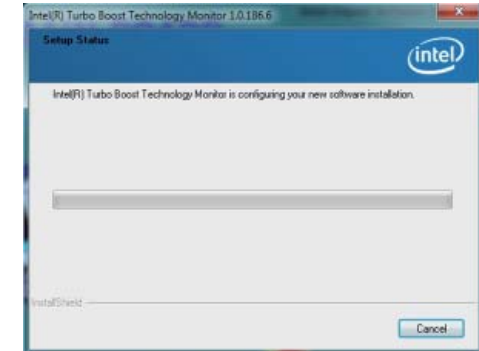

2. Click Next.

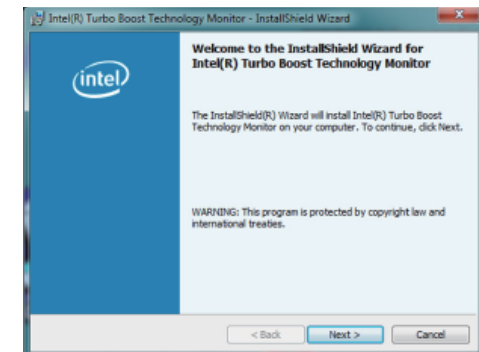

3. Read the license agreement and then click “I accept the terms in the license agreement”. Click Next.



4. Click Install.



5. The setup program is currently installing the software.



6. Click Finish.



Intel Rapid Start Technology (For Windows 7 Only)

The Intel Rapid Start Technology is a utility that allows your system to wake up and run faster. To install the driver, click "Intel Rapid Start Technology" on the main menu.

1. Setup is now ready to install the utility. Click Next.



2. Click ON and select the Advanced Settings to enable the Intel Rapid Start Technology. Then, click Save.

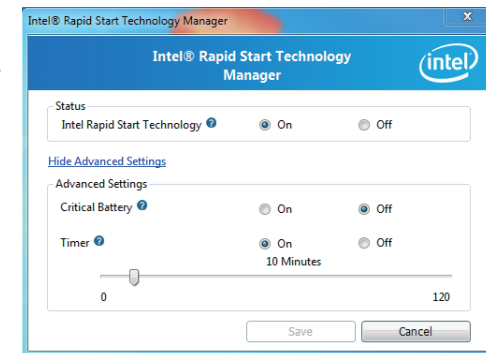

Infineon TPM Driver and Tool (optional)

To install the driver, click “Infineon TPM driver and tool (option)” on the main menu.

1. The setup program is preparing to install the driver.

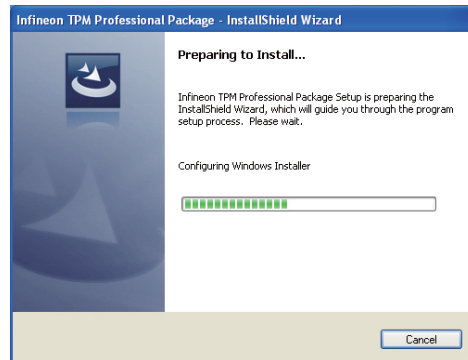

2. The setup program is now ready to install the utility. Click Next.

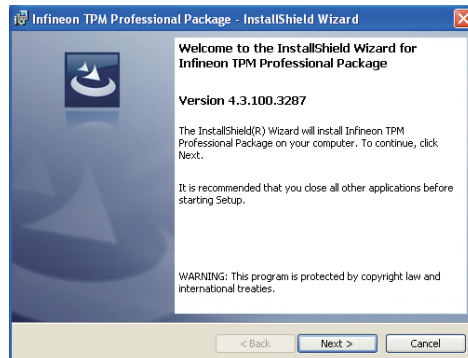

3. Click “I accept the terms in the license agreement” and then click “Next”.

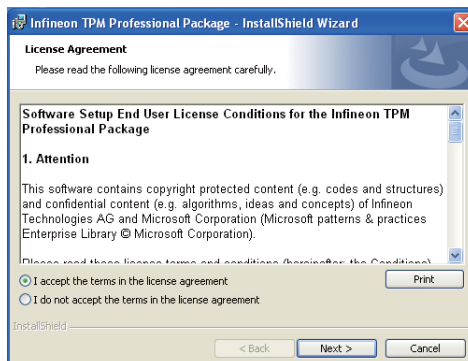

4. Enter the necessary information and then click Next.

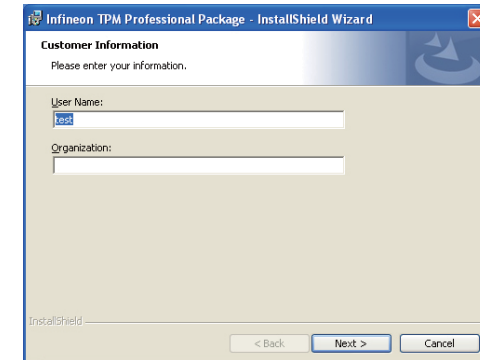

5. Select a setup type and then click Next.

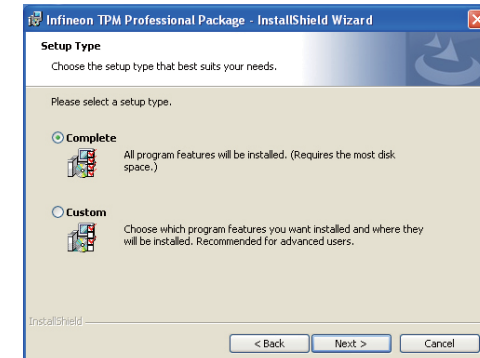

6. Click Install.

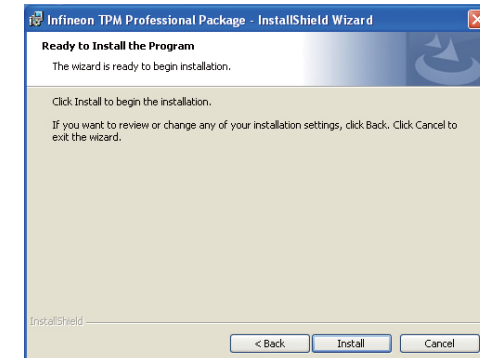

7. TPM requires installing the Microsoft Visual C++ package prior to installing the utility. Click Install.

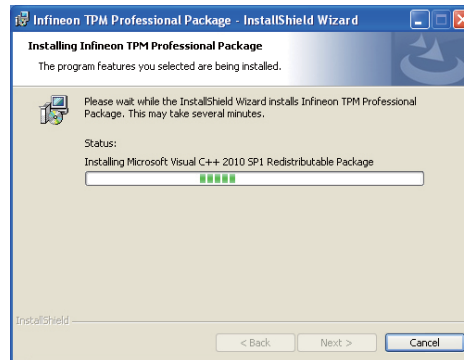

8. The setup program is currently installing the Microsoft Visual C++ package.

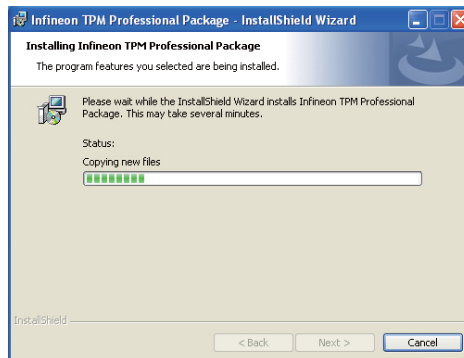

9. Click Finish.



10. Click "Yes" to restart your system.

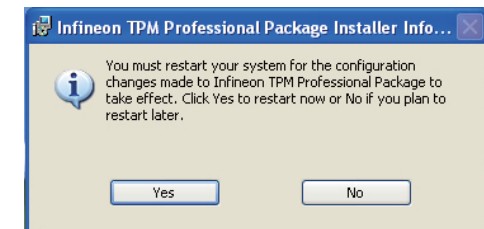

Adobe Acrobat Reader 9.3

To install the reader, click “Adobe Acrobat Reader 9.3” on the main menu.

1. Click Next to install or click Change Destination Folder to select another folder.

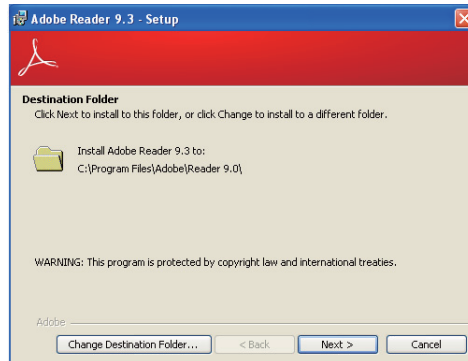

2. Click Install to begin installation.

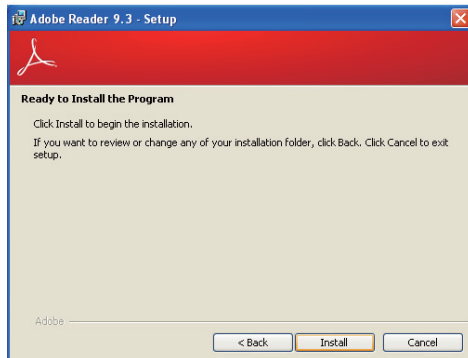

3. Click Finish to exit installation.

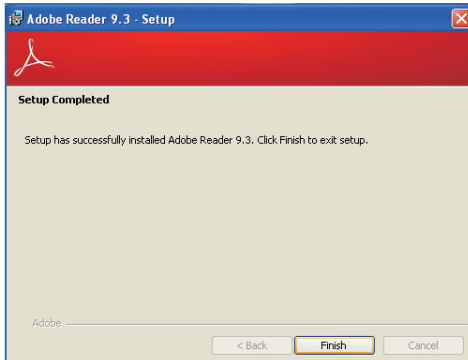

Chapter 5 - Digital I/O Programming Guide

Register Description

The Input Port Register (register 0) reflects the incoming logic levels of the pins, regardless of whether the pin is defined as an input or output by the Configuration Register. They act only on the read operation. Writes to this register have no effect. The default value (X) is determined by the externally applied logic level. Before a read operation, a write transmission is sent with the command byte to indicate to the I²C device that the Input Port Register will be accessed next.

Register 0 (Input Port Register)

BIT	I-7	I-6	I-5	I-4	I-3	I-2	I-1	I-0
DEFAULT	X	X	X	X	X	X	X	X

The Output Port Register (register 1) shows the outgoing logic levels of the pins defined as outputs by the Configuration Register. Bit values in this register have no effect on pins defined as inputs. In turns, reads from this register reflect the value that is in the flip-flop controlling the output selection, not the actual pin value.

Register 1 (Output Port Register)

BIT	O-7	O-6	O-5	O-4	O-3	O-2	O-1	O-0
DEFAULT	1	1	1	1	1	1	1	1

The Polarity Inversion Register (register 2) allows polarity inversion of the pins defined as inputs by the Configuration Register. If a bit in this register is set (written with 1), the corresponding port pin's polarity is inverted. If a bit in this register is clear (written with a 0), the corresponding port pin's original polarity is retained.

Register 2 (Polarity Inversion Register)

BIT	N-7	N-6	N-5	N-4	N-3	N-2	N-1	N-0
DEFAULT	0	0	0	0	0	0	0	0

The Configuration Register (register 3) configures the direction of the I/O pins. If a bit in this register is set to 1, the corresponding port pin is enabled as an input with a high-impedance output driver. If a bit in this register is cleared to 0, the corresponding port is enabled as an input.

Register 3 (Configuration Register)

BIT	C-7	C-6	C-5	C-4	C-3	C-2	C-1	C-0
DEFAULT	1	1	1	1	1	1	1	1

Function Description

I2CWriteByte(SlaveAddr, SubAddr, Data):
Write a Byte data to a specified I2C Device.

I2CReadByte(SlaveAddr, SubAddr, *Data):
Read a Byte data from a specified I2C Device.

SetBit(*Data, Bit) :
Set Data bit n as "1".

ClrBit(*Data, Bit) :
Set Data bit n as "0".

GetBit(Data, Bit) :
Return the value of data bit n.

Sample Code

GPIO Configuration

```
#define SLAVE_ADDR      0x42
#define INPUT_PORT      0x00
#define OUTPUT_PORT     0x01
#define INVERSION_PORT  0x02
#define COMFIG_PORT     0x03

GpioConfig(int PinNum, int Mode)
{
    BYTE Data;
    BYTE TempPinNum = PinNum%8;

    //Pin0-7 Input/Output Configuration
    I2C_ReadByte(SLAVE_ADDR, CONFIG_PORT, &Data);
    if(Mode == 1){SetBit(&Data, TempPinNum);} //Input
    else      {ClrBit(&Data, TempPinNum);} //Output
    I2C_WriteByte(SLAVE_ADDR, CONFIG_PORT, Data);

    return 1;
}
```

GPIO Output Process

```
#define SLAVE_ADDR      0x42
#define INPUT_PORT      0x00
#define OUTPUT_PORT     0x01
#define INVERSION_PORT  0x02
#define COMFIG_PORT     0x03

GpioOut(int PinNum, int Level)
{
    BYTE Data;
    BYTE TempPinNum = PinNum%8;

    //Pin0-7
    I2C_ReadByte(SLAVE_ADDR, OUTPUT_PORT, &Data);
    if(Level == 0){ClrBit(&Data, TempPinNum);}
    else      {SetBit(&Data, TempPinNum);}
    I2C_WriteByte(SLAVE_ADDR, OUTPUT_PORT, Data);

    return 1;
}
```

GPIO Input Process

```
#define SLAVE_ADDR      0x42
#define INPUT_PORT      0x00
#define OUTPUT_PORT     0x01
#define INVERSION_PORT  0x02
#define COMFIG_PORT     0x03

GpioIn(int PinNum, int *Status)
{
    BYTE Data;
    BYTE Group = PinNum/8;
    BYTE TempPinNum = PinNum%8;

    //Pin0-7
    I2C_ReadByte(SLAVE_ADDR, INPUT_PORT, &Data);
    *Status = GetBit(Data, TempPinNum);

    return 1;
}
```

Chapter 6 - RAID (HM101-QM87)

The system board allows configuring RAID on Serial ATA drives. It supports RAID 0, RAID 1, RAID 5 and RAID 10.

RAID Levels

RAID 0 (Striped Disk Array without Fault Tolerance)

RAID 0 uses two new identical hard disk drives to read and write data in parallel, interleaved stacks. Data is divided into stripes and each stripe is written alternately between two disk drives. This improves the I/O performance of the drives at different channel; however it is not fault tolerant. A failed disk will result in data loss in the disk array.

RAID 1 (Mirroring Disk Array with Fault Tolerance)

RAID 1 copies and maintains an identical image of the data from one drive to the other drive. If a drive fails to function, the disk array management software directs all applications to the other drive since it contains a complete copy of the drive's data. This enhances data protection and increases fault tolerance to the entire system. Use two new drives or an existing drive and a new drive but the size of the new drive must be the same or larger than the existing drive.

Settings

To enable the RAID function, the following settings are required.

1. Connect the Serial ATA drives.
2. Configure Serial ATA in the AMI BIOS.
3. Configure RAID in the RAID BIOS.
4. Install the RAID driver during OS installation.
5. Install the Intel Rapid Storage Drivers.

Step 1: Connect the Serial ATA Drives

Refer to chapter 2 for details on connecting the Serial ATA drives.

**Important:**

1. Make sure you have installed the Serial ATA drives and connected the data cables otherwise you won't be able to enter the RAID BIOS utility.
2. Treat the cables with extreme caution especially while creating RAID. A damaged cable will ruin the entire installation process and operating system. The system will not boot and you will lost all data in the hard drives. Please give special attention to this warning because there is no way of recovering back the data.

Step 2: Configure Serial ATA in the AMI BIOS

1. Power-on the system then press to enter the main menu of the AMI BIOS.
2. Configure Serial ATA in the appropriate fields.
3. Save the changes in the Save & Exit menu.
4. Reboot the system.

Step 3: Configure RAID in the RAID BIOS

When the system powers-up and all drives have been detected, the Intel RAID BIOS status message screen will appear. Press the <Ctrl> and <I> keys simultaneously to enter the utility. The utility allows you to build a RAID system on Serial ATA drives.

Step 4: Install the RAID Driver During OS Installation

The RAID driver must be installed during the Windows® XP or Windows® 2000 installation using the F6 installation method. This is required in order to install the operating system onto a hard drive or RAID volume when in RAID mode or onto a hard drive when in AHCI mode.

1. Start Windows Setup by booting from the installation CD.
2. Press <F6> when prompted in the status line with the 'Press F6 if you need to install a third party SCSI or RAID driver' message.
3. Press <S> to "Specify Additional Device".
4. At this point you will be prompted to insert a floppy disk containing the RAID driver. Insert the RAID driver diskette.
5. Locate for the drive where you inserted the diskette then select RAID or AHCI controller that corresponds to your BIOS setup. Press <Enter> to confirm.

You have successfully installed the driver. However you must continue installing the OS. Leave the floppy disk in the floppy drive until the system reboots itself because Windows setup will need to copy the files again from the floppy disk to the Windows installation folders. After Windows setup has copied these files again, remove the floppy diskette so that Windows setup can reboot as needed.

Step 5: Install the Intel Rapid Storage Technology Utility

The Intel Rapid Storage Technology Utility can be installed from within Windows. It allows RAID volume management (create, delete, migrate) from within the operating system. It will also display useful SATA device and RAID volume information. The user interface, tray icon service and monitor service allow you to monitor the current status of the RAID volume and/or SATA drives. It enables enhanced performance and power management for the storage subsystem.

1. Insert the provided CD into an optical drive.
2. Click "Intel Rapid Storage Technology Utility" on the main menu.
3. Setup is ready to install the utility. Click Next.

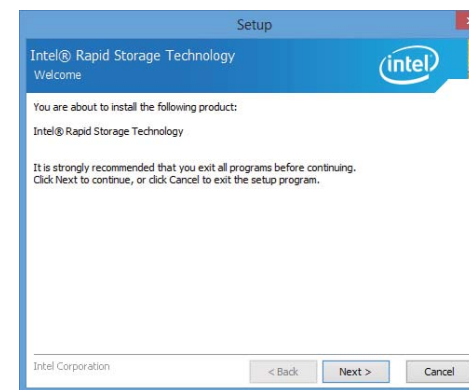

4. Read the license agreement and click "I accept the terms in the License Agreement." Then, click Next.

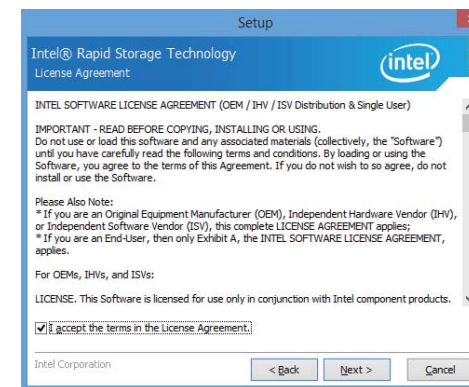

5. Go through the readme document to view system requirements and installation information then click Next.

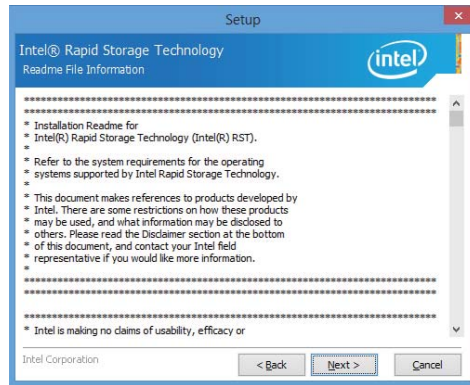

6. Click Next to install to the default folder or click change to choose another destination folder.

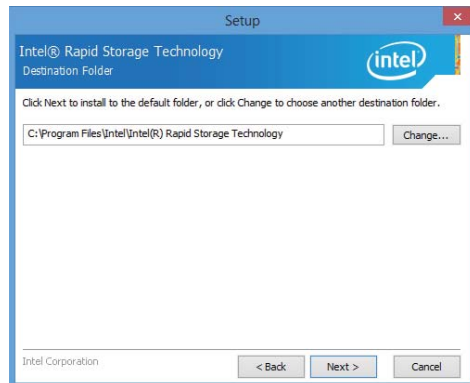

7. Confirm the installation and click Next.

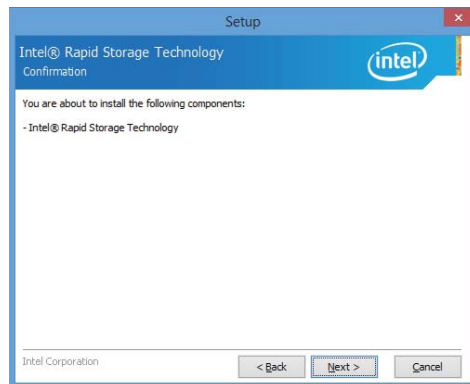

8. Click "Yes, I want to restart this computer now" to complete the installation and then click Finish.



Chapter 7 - Intel AMT Settings (HM101-QM87)

Overview

Intel Active Management Technology (Intel® AMT) combines hardware and software solution to provide maximum system defense and protection to networked systems.

The hardware and software information are stored in non-volatile memory. With its built-in manageability and latest security applications, Intel® AMT provides the following functions.

- **Discover**

Allows remote access and management of networked systems even while PCs are powered off; significantly reducing desk-side visits.

- **Repair**

Remotely repair systems after OS failures. Alerting and event logging help detect problems quickly to reduce downtime.

- **Protect**

Intel AMT's System Defense capability remotely updates all systems with the latest security software. It protects the network from threats at the source by proactively blocking incoming threats, reactively containing infected clients before they impact the network, and proactively alerting when critical software agents are removed.

Enable Intel® AMT in the AMI BIOS

1. Power-on the system then press to enter the main menu of the AMI BIOS.
2. In the **Advanced** menu, select **AMT Configuration**.

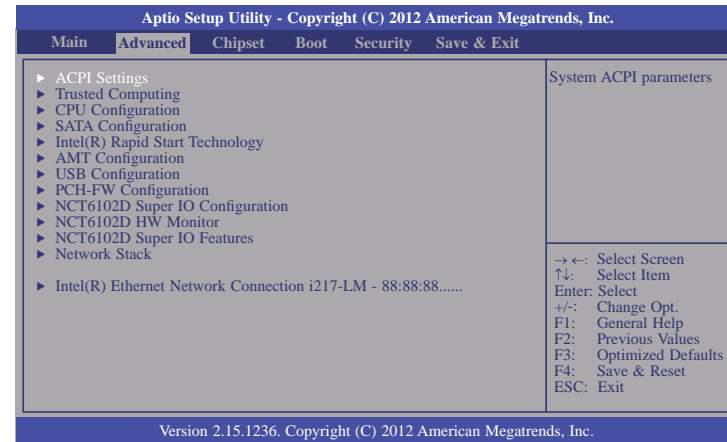

3. In the **Advanced** menu, select **Enable** in the **AMT** field.

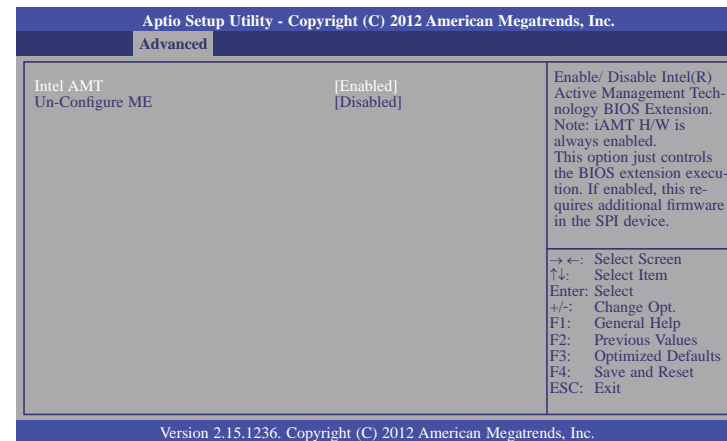

4. In the **Save & Exit** menu, select **Save Changes and Reset** then select **OK**.

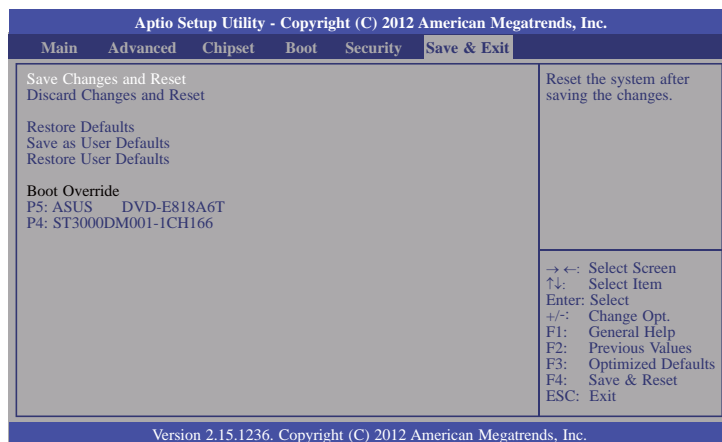

Enable Intel® AMT in the Intel® Management Engine BIOS Extension (MEBX) Screen

1. When the system reboots, the following message will be displayed. Press **<Ctrl-P>** as soon as the message is displayed; as this message will be displayed for only a few seconds.



2. You will be prompted for a password. The default password is "**admin**". Enter the default password in the space provided under Intel(R) ME Password then press Enter.

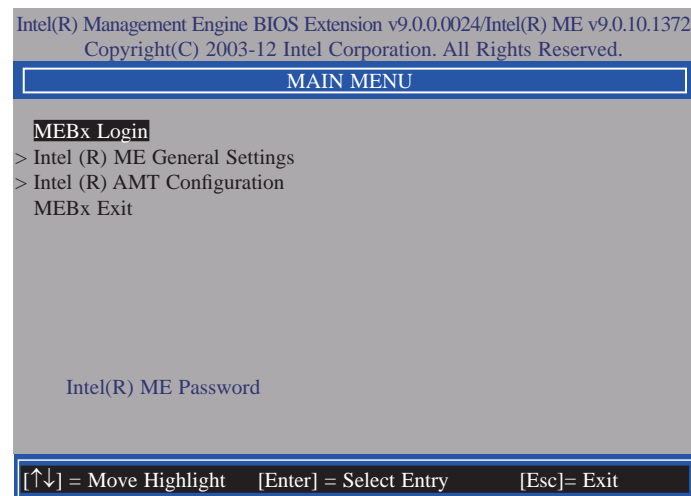

3. Enter a new password in the space provided under Intel(R) ME New Password then press Enter. The password must include:
- 8-32 characters
 - Strong 7-bit ASCII characters excluding : , and " characters
 - At least one digit character (0, 1, ...9)
 - At least one 7-bit ASCII non alpha-numeric character, above 0x20, (e.g. !, \$, ;)
 - Both lower case and upper case characters

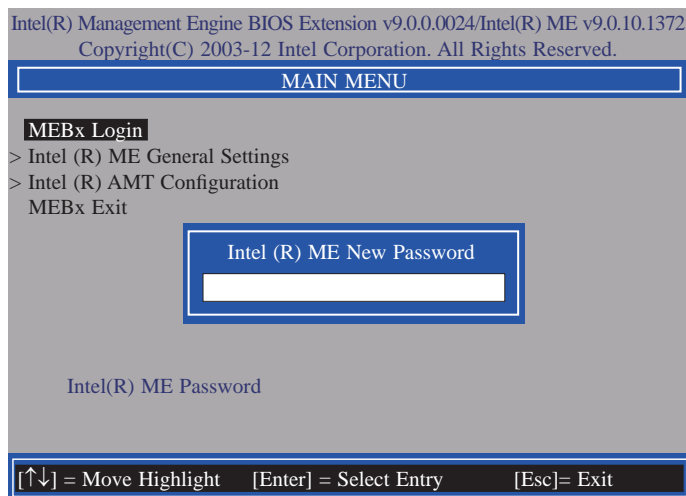

4. You will be asked to verify the password. Enter the same new password in the space provided under Verify Password then press Enter.

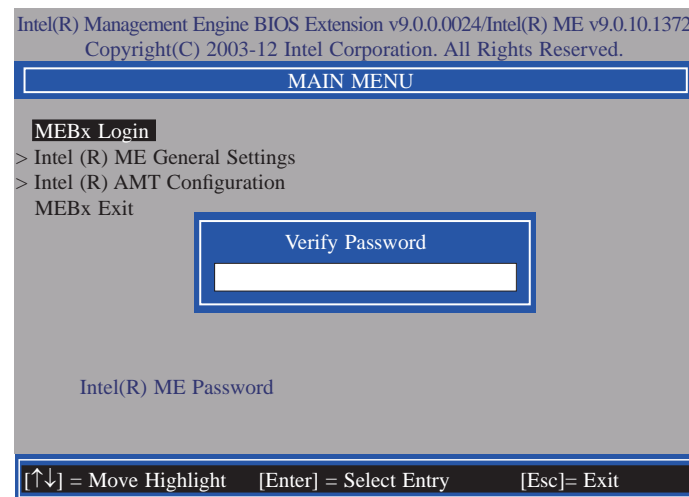

5. Select **Intel(R) ME General Settings** then press Enter.

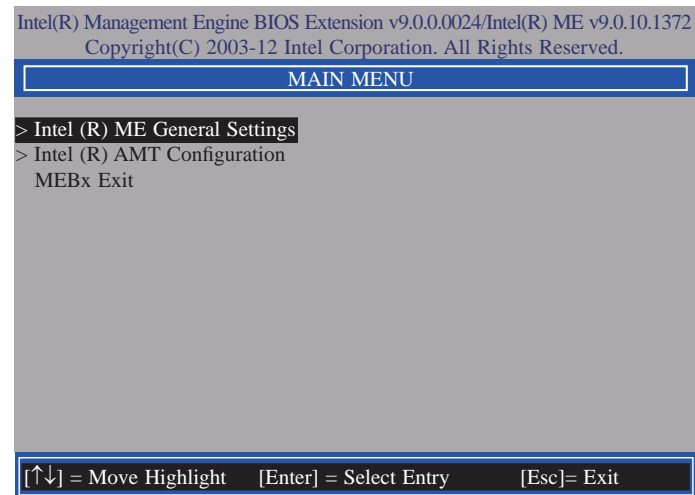

6. Select **Change Intel(R) ME Password** then press Enter.

You will be prompted for a password. The default password is "**admin**". Enter the default password in the space provided under Intel(R) ME New Password then press Enter.

- 8-32 characters
- Strong 7-bit ASCII characters excluding : , and " characters
- At least one digit character (0, 1, ...9)
- At least one 7-bit ASCII non alpha-numeric character, above 0x20, (e.g. !, \$, ;)
- Both lower case and upper case characters

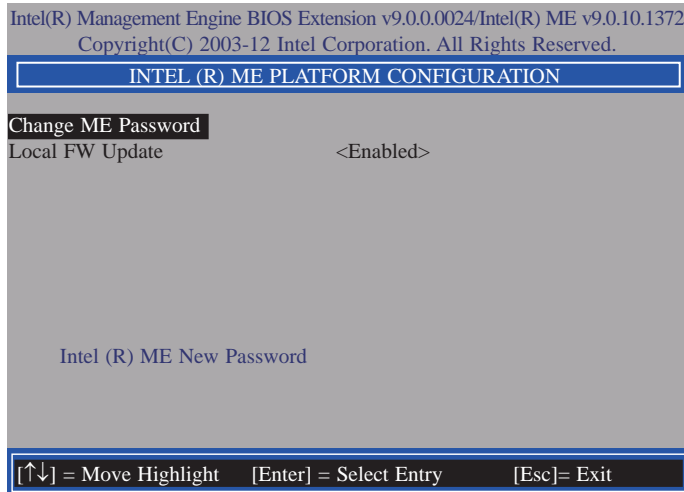

7. Select **Local FW Update** then press Enter. Select **Enabled** then press Enter.

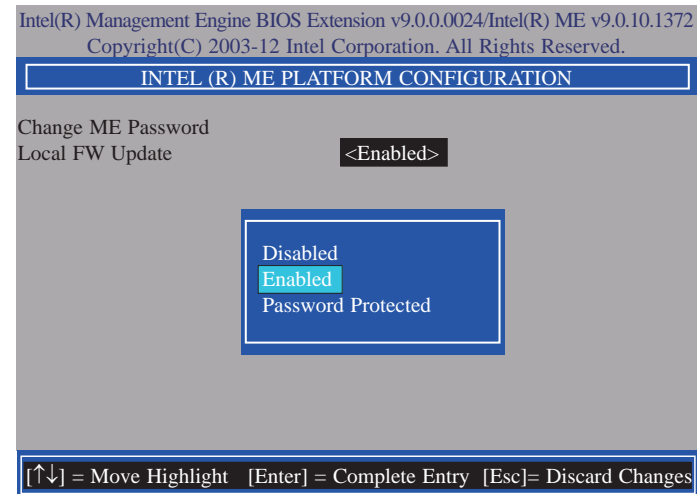

8. Select Previous Menu until you return to the **Main Menu**. Select **Intel(R) AMT Configuration** then press Enter.

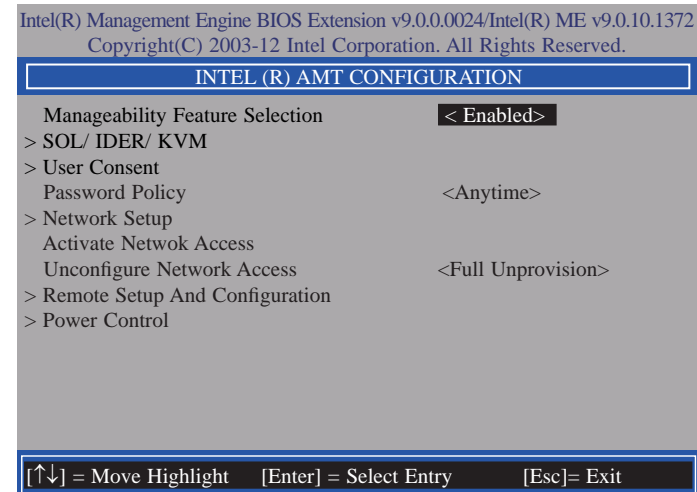

9. In the **Intel(R) AMT Configuration** menu, select **Manageability Feature Selection** then press Enter. Select **Disabled** then press Enter.

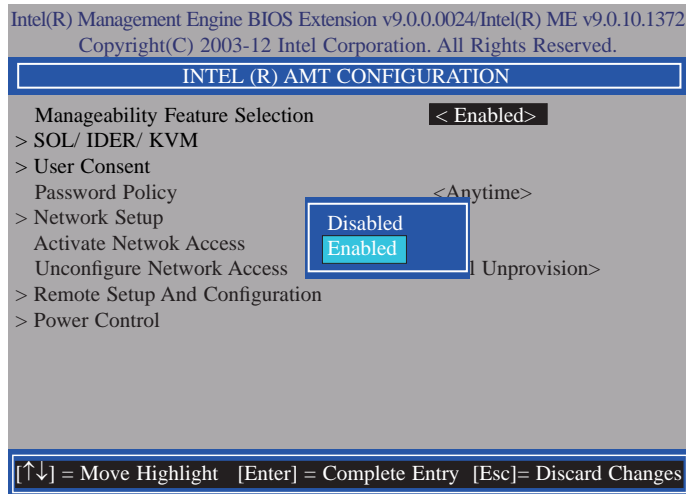

11. In the **SOL/IDER/KVM** menu, select **Username and Password** then press Enter. Select **Disabled** then press Enter.

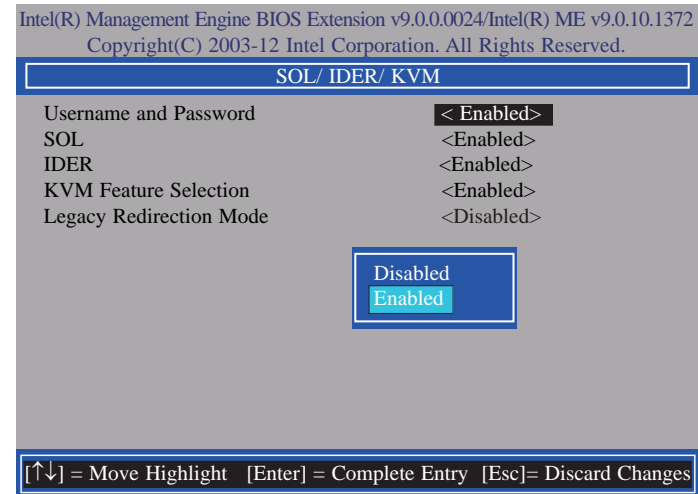

10. In the **Intel(R) AMT Configuration** menu, select **SOL/IDER/KVM** then press Enter.

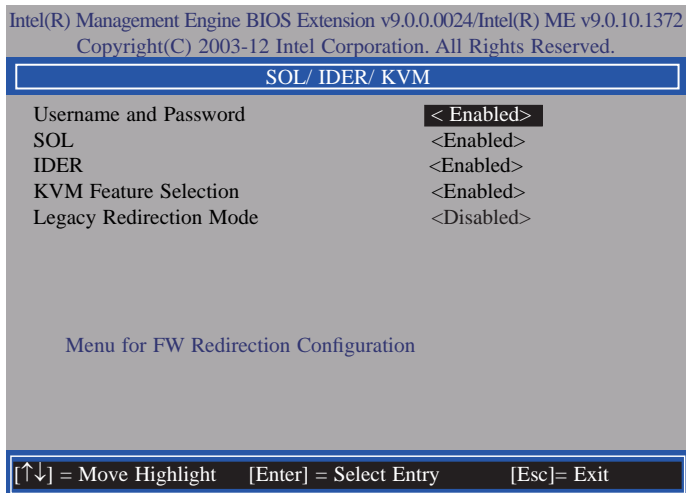

12. In the **SOL/IDER/KVM** menu, select **SOL** then press Enter. Select **Disabled** then press Enter.

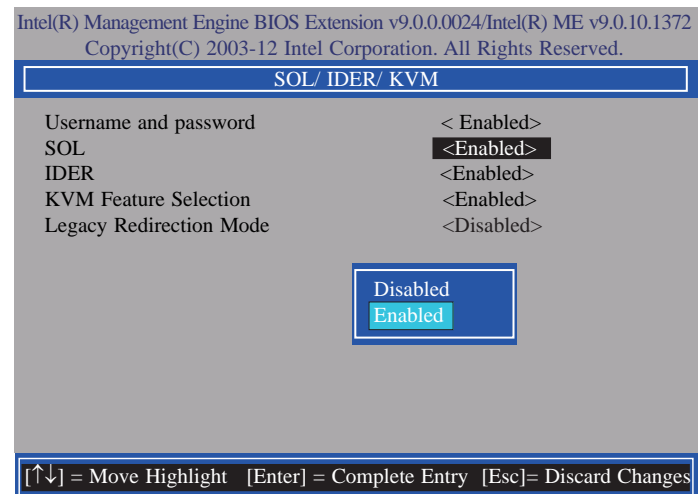

13. In the **SOL/IDER/KVM** menu, select **IDER** then press Enter. Select **Disabled** then press Enter.

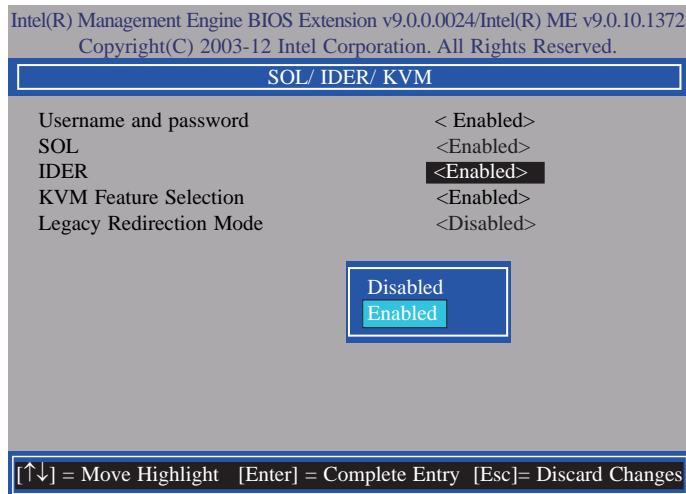

15. In the **SOL/IDER/KVM** menu, select **Legacy Redirection Mode** then press Enter.

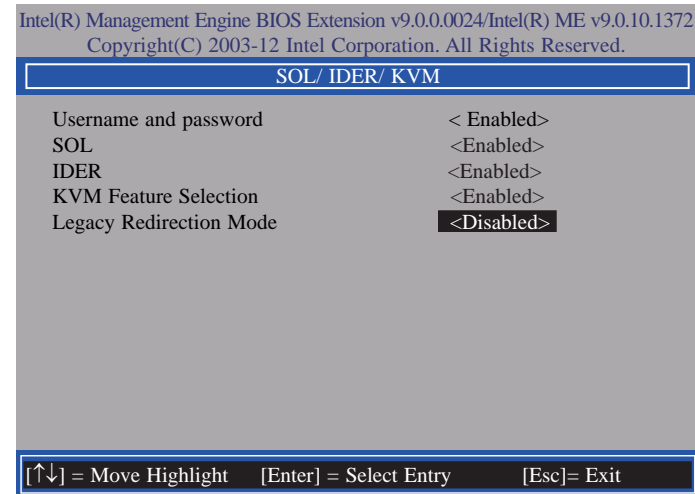

14. In the **SOL/IDER/KVM** menu, select **KVM Feature Selection** then press Enter. Select **Disabled** then press Enter.

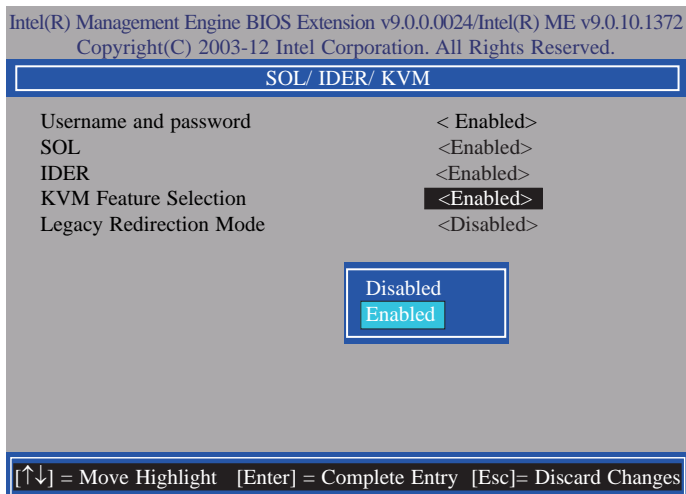

16. Select **Enabled** then press Enter.

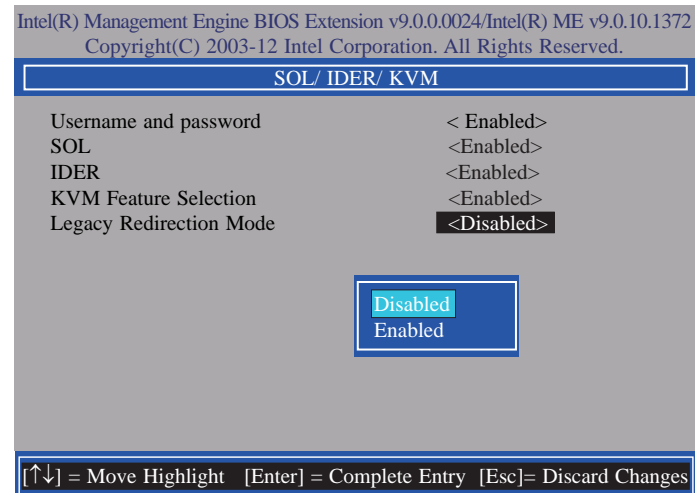

17. Select Previous Menu until you return to the **Intel(R) AMT Configuration** menu. Select **User Consent** then press Enter.

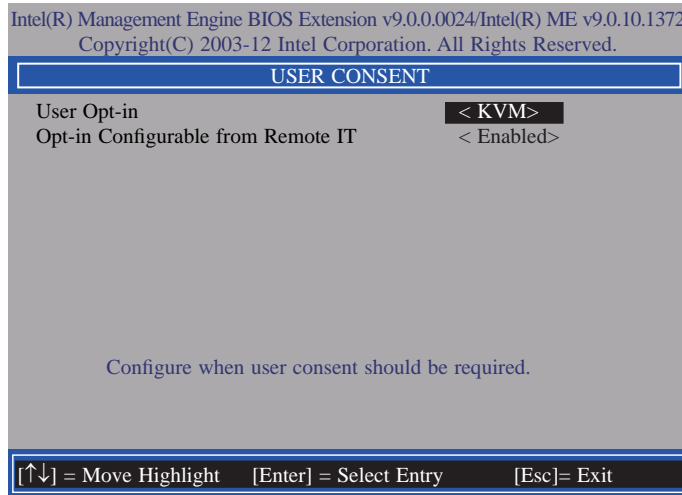

19. In the **User Consent** menu, select **Opt-in Configurable from Remote IT** then press Enter. Select **Disable Remote Control of KVM Opt-in Policy** then press Enter.

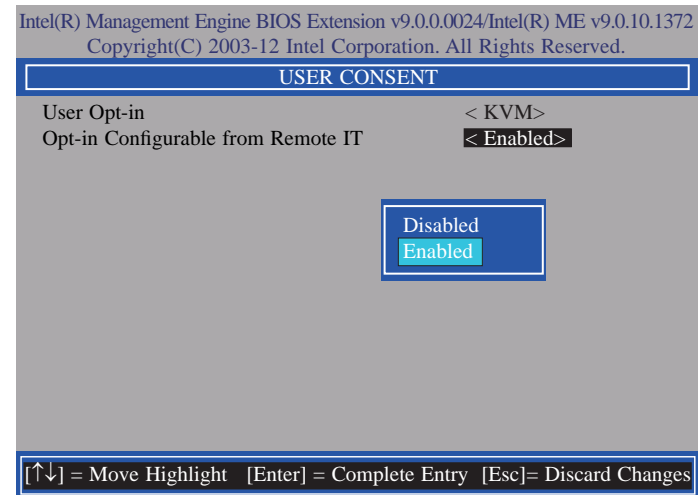

18. In the **User Consent** menu, select **User Opt-in** then press Enter. Select **None** then press Enter.

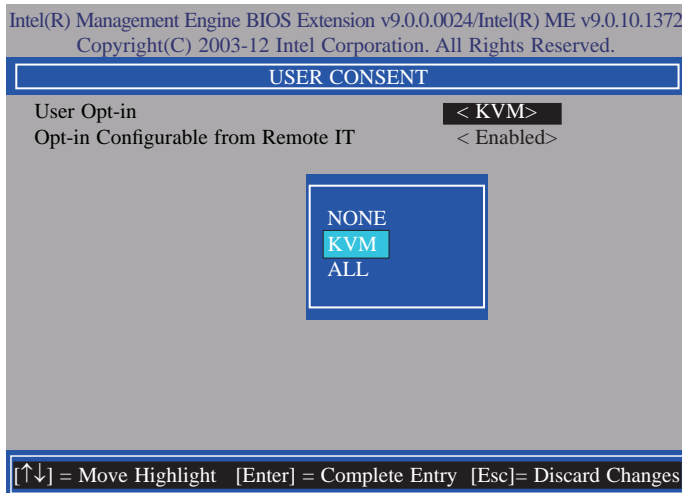

20. Select Previous Menu until you return to the **Intel(R) AMT Configuration** menu. Select **Password Policy** then press Enter.

You may choose to use a password only during setup and configuration or to use a password anytime the system is being accessed.

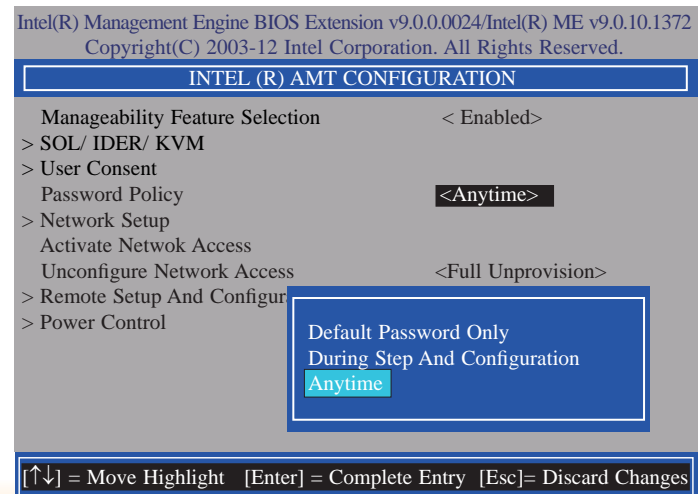

21. In the **Intel(R) AMT Configuration** menu, select **Network Setup** then press Enter.

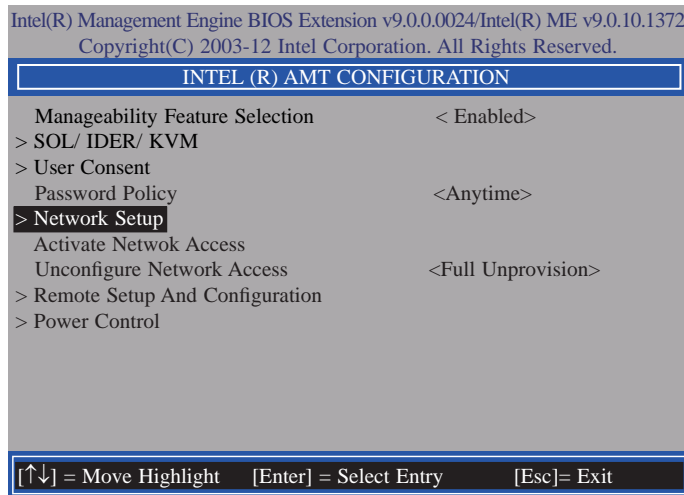

22. In the **Intel(R) ME Network Setup** menu, select **Intel(R) ME Network Name Settings** then press Enter.

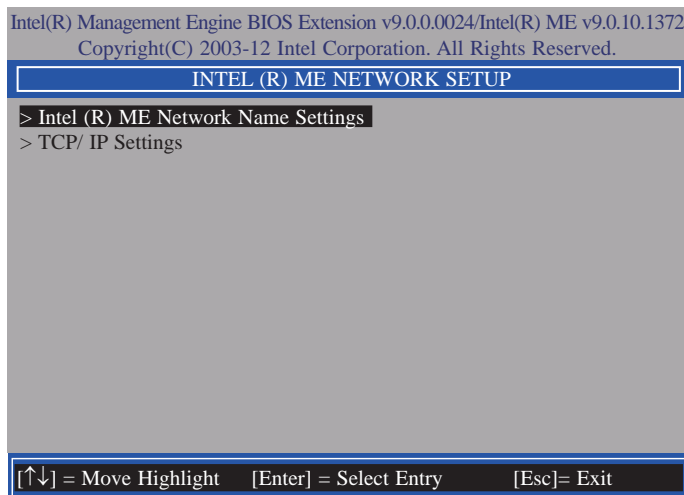

23. In the **Intel(R) ME Network Name Settings** menu, select **Host Name** then press Enter. Enter the computer's host name then press Enter.

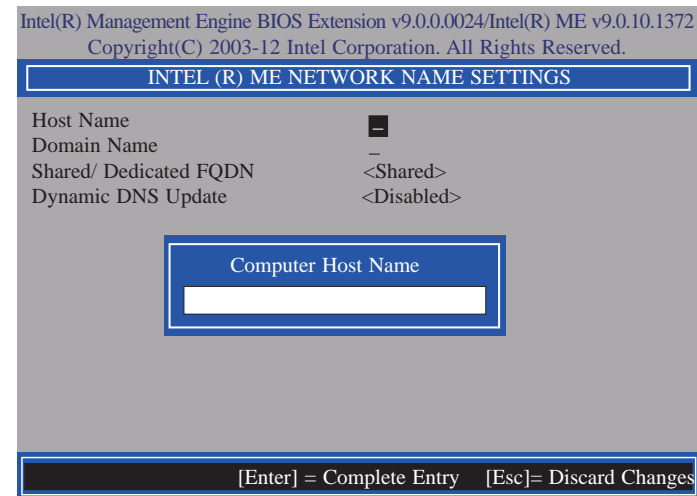

24. Select **Domain Name** then press Enter. Enter the computer's domain name then press Enter.

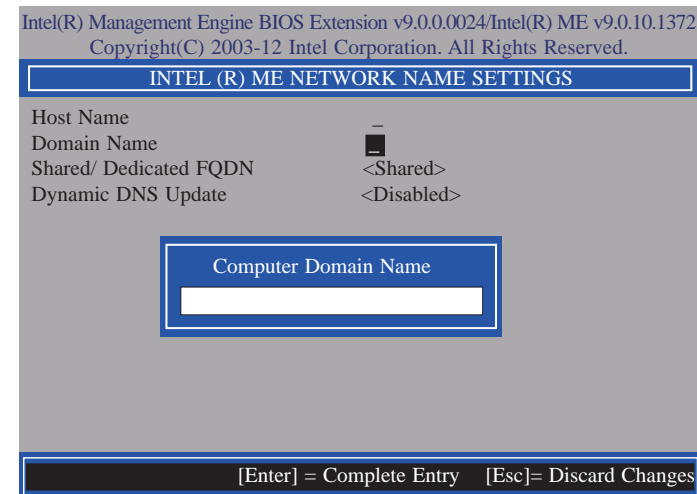

25. Select **Shared/Dedicated FQDN** then press Enter. Select **Shared** or **Dedicated** then press Enter.

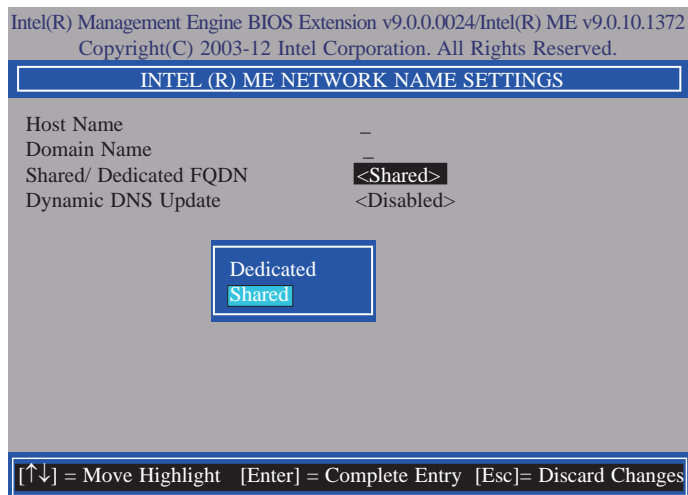

26. Select **Dynamic DNS Update** then press Enter. Select **Enabled** or **Disabled** then press Enter.

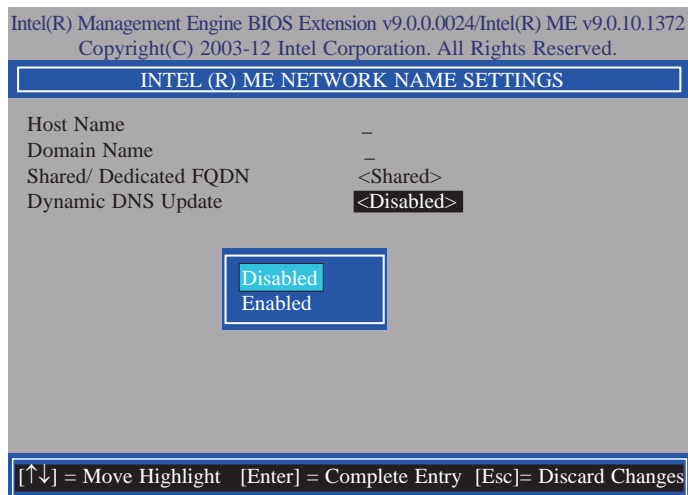

27. Select Previous Menu until you return to the **Intel(R) ME Network Setup** menu. Select **TCP/IP Settings** then press Enter.

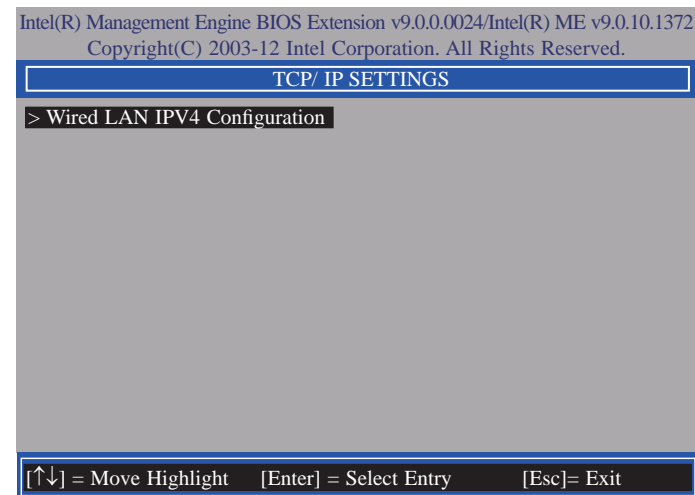

28. In the **TCP/IP Settings** menu, select **Wired LAN IPV4 Configuration** then press Enter.

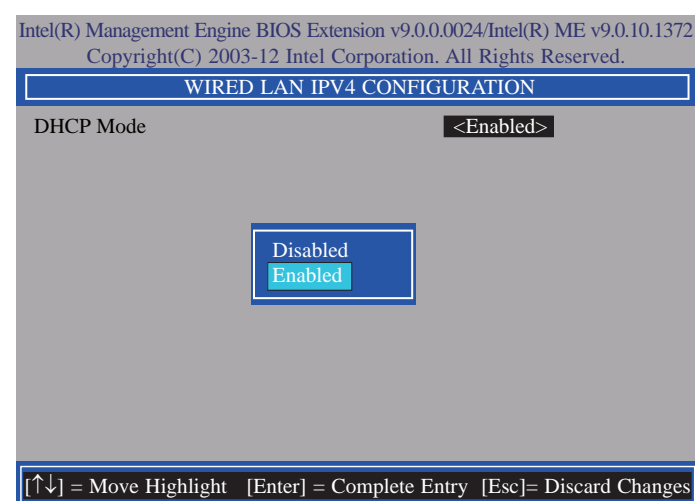

29. Select Previous Menu until you return to the **Intel(R) AMT Configuration** menu. Select **Activate Network Access** then press Enter. Type **Y** then press Enter.

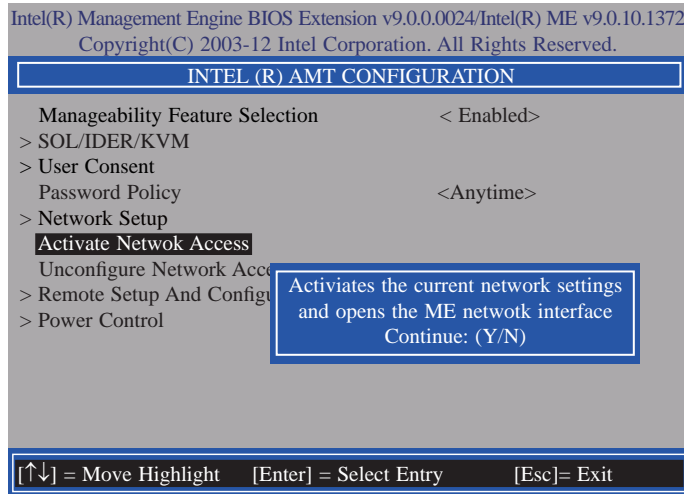

31. In the **Intel(R) AMT Configuration** menu, select **Remote Setup And Configuration** then press Enter.

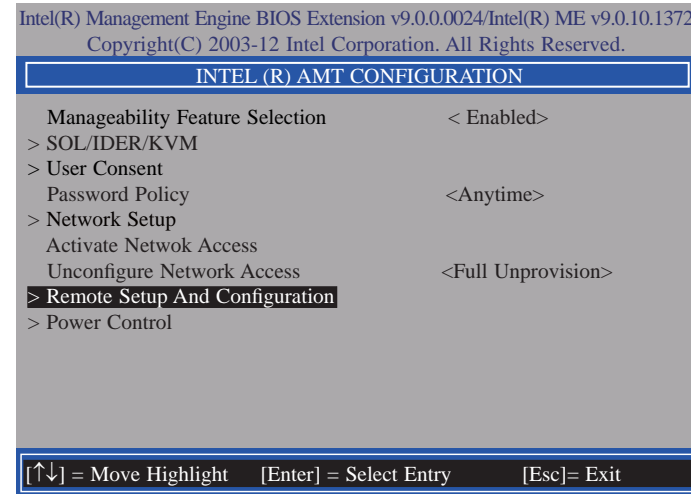

30. In the **Intel(R) AMT Configuration** menu, select **Unconfigure Network Access** then press Enter.



32. In the **Intel(R) Remote Setup And Configuration** menu, select **Current Provisioning Mode** then press Enter.

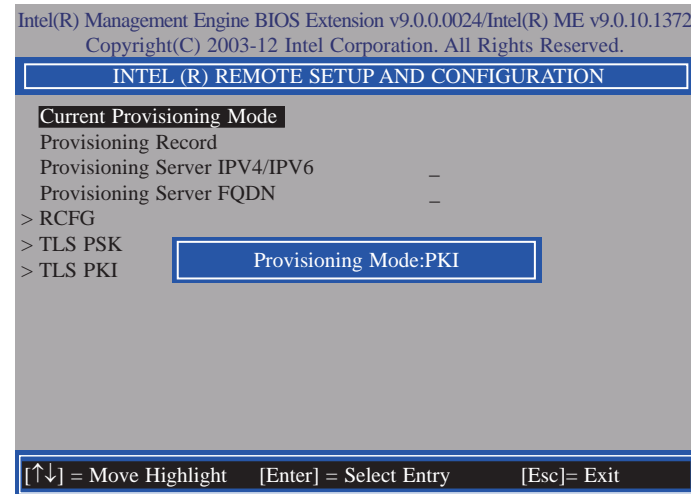

33. In the **Intel(R) Remote Setup And Configuration** menu, select **Provisioning Record** then press Enter.

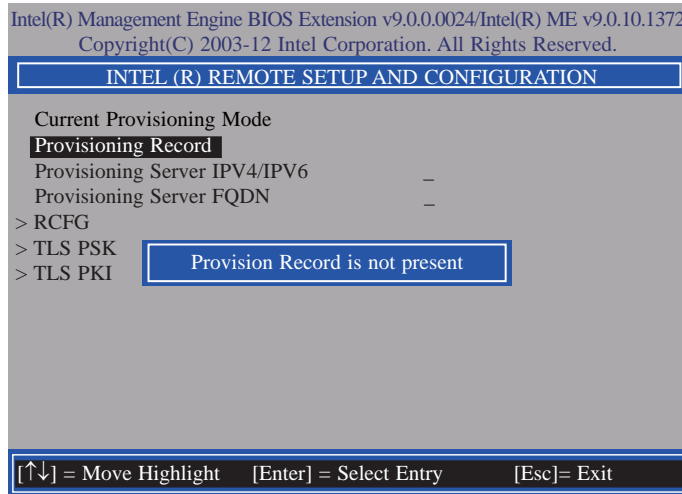

35. In the **Intel(R) Remote Automated Setup And Configuration** menu, select **Provisioning Server FQDN** then press Enter. Type FQDN of provisioning server then press Enter.

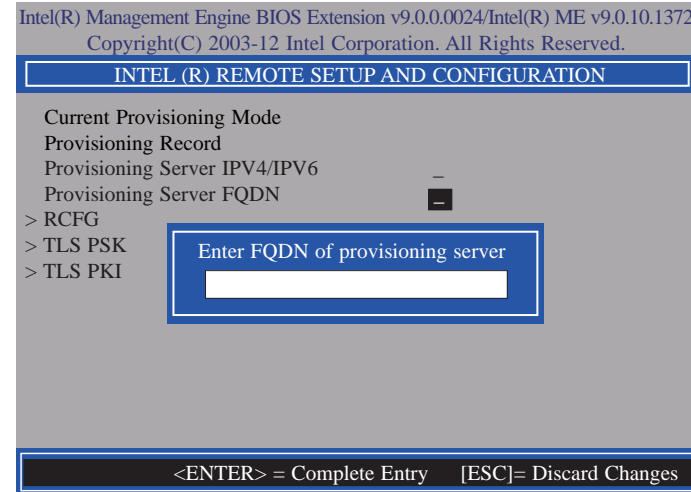

34. Select Previous Menu until you return to the **Intel(R) Remote Setup And Configuration** menu. Select **Provisioning Server IPV4/IPV6** then press Enter. Type server address then press Enter.

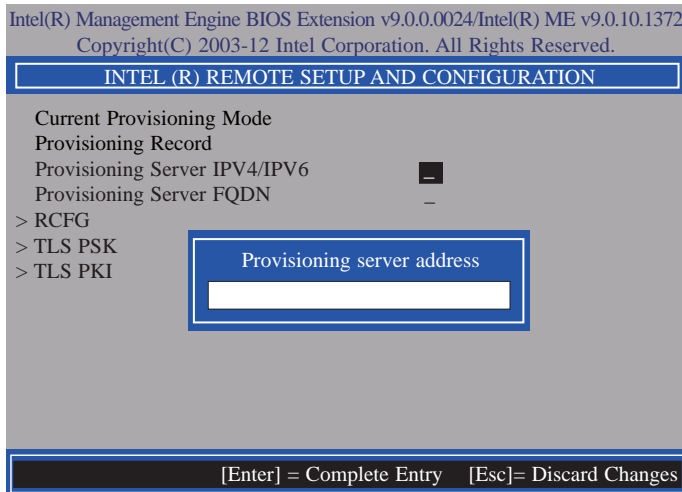

36. In the **Intel(R) Remote Automated Setup And Configuration** menu, select **RCFG** then press Enter. Select **Start Configuration**, and type **Y** then press Enter.

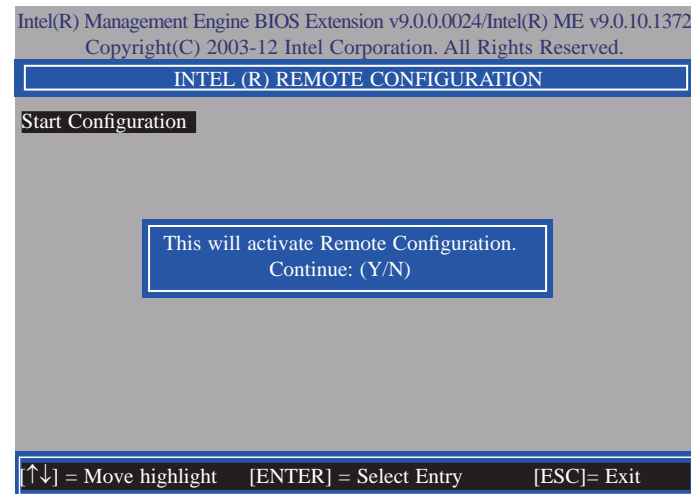

37. In the **Intel(R) Remote Automated Setup And Configuration** menu, select **TLS PSK** then press Enter.

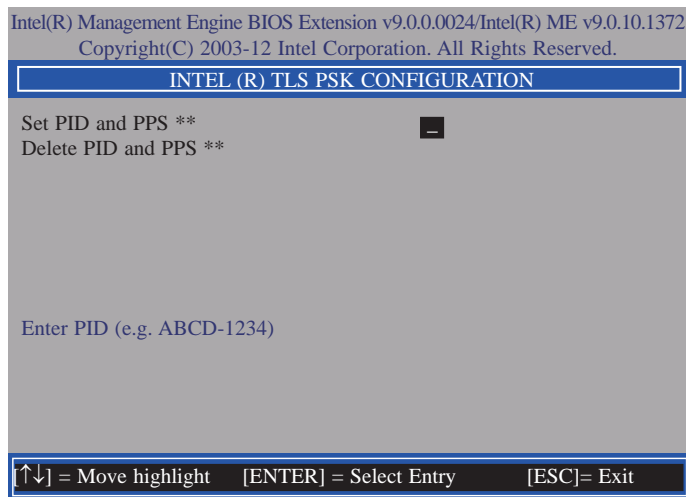

38. In the **Intel(R) TLS PSK Configuration** menu, select **Set PID and PPS **** then press Enter. Type PID code then press Enter.

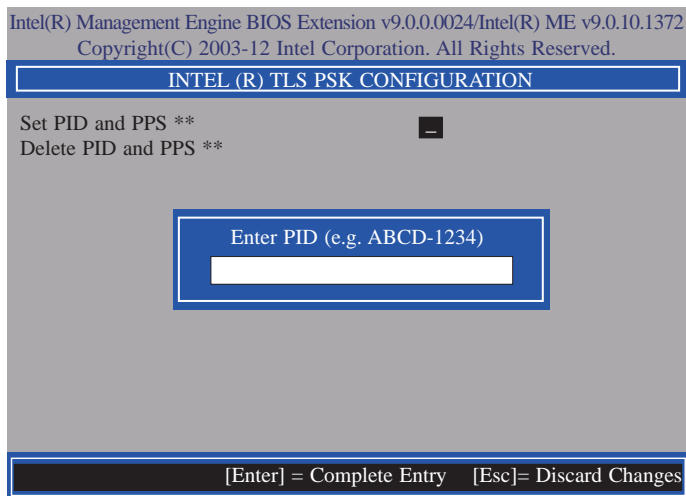

39. In the **Intel(R) TLS PSK Configuration** menu, select **Delete PID and PPS **** then press Enter. Type Y then press Enter.

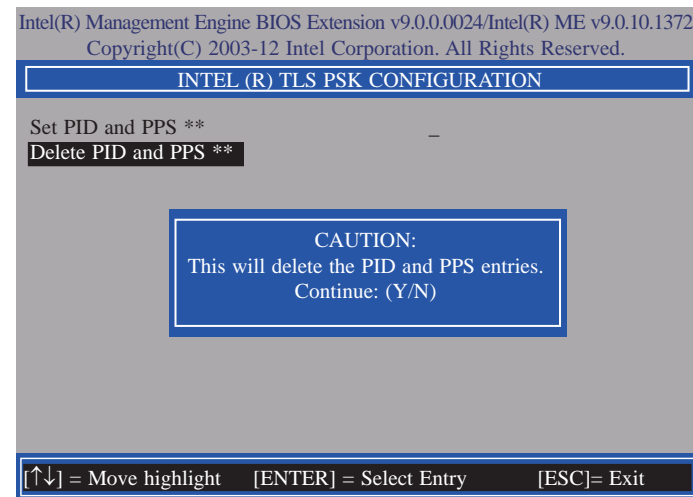

40. Select Previous Menu until you return to the **Intel(R) Remote Setup And Configuration** menu. Select **TLS PKI** then press Enter.

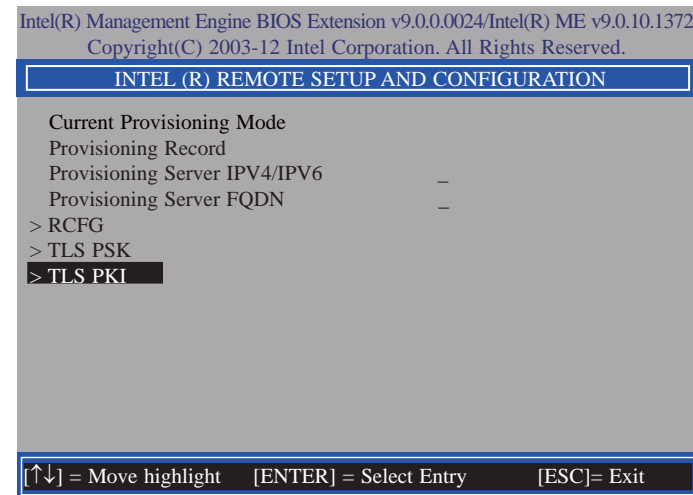

41. In the **Intel(R) Remote Configuration** menu, select **Remote Configuration **** then press Enter. Select **Disabled** then press Enter.

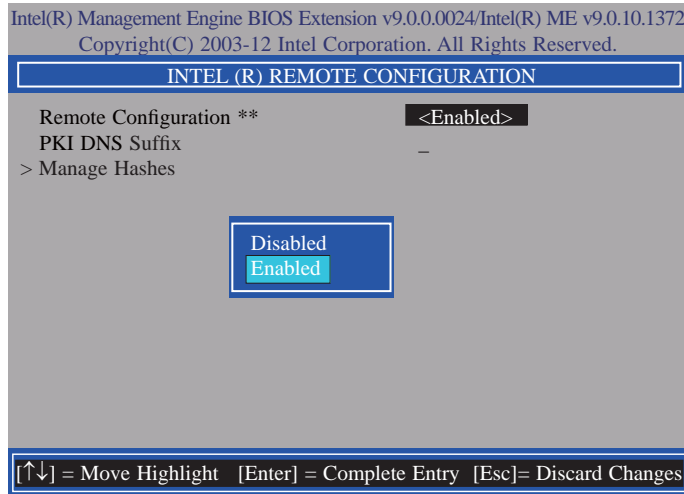

42. In the **Intel(R) Remote Configuration** menu, select **PKI DNS Suffix** then press Enter. Type PKI DNS Suffix then press Enter.

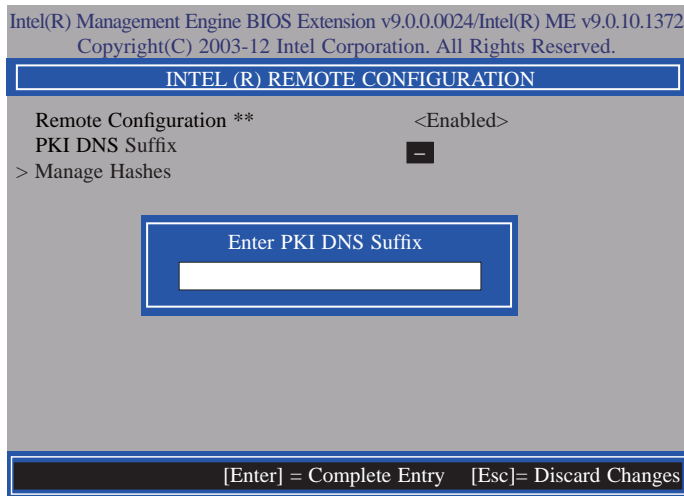

43. In the **Intel(R) Remote Configuration** menu, select **Manage Hashes** then press Enter.

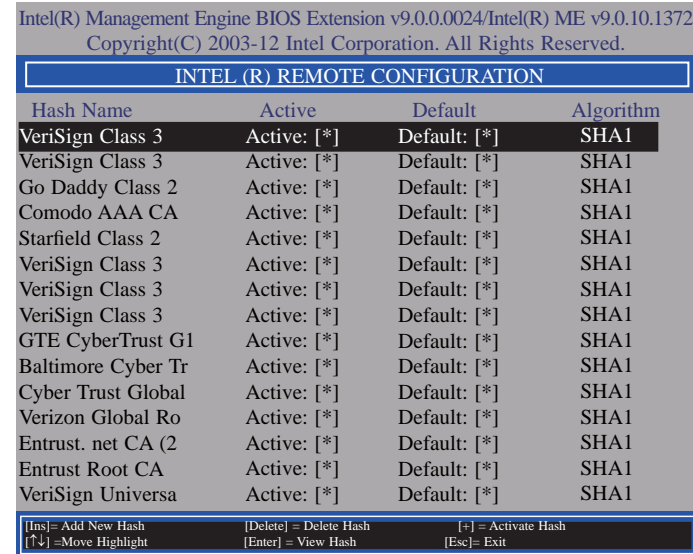

44. In the **Intel(R) AMT Configuration** menu, select **Power Control** then press Enter.

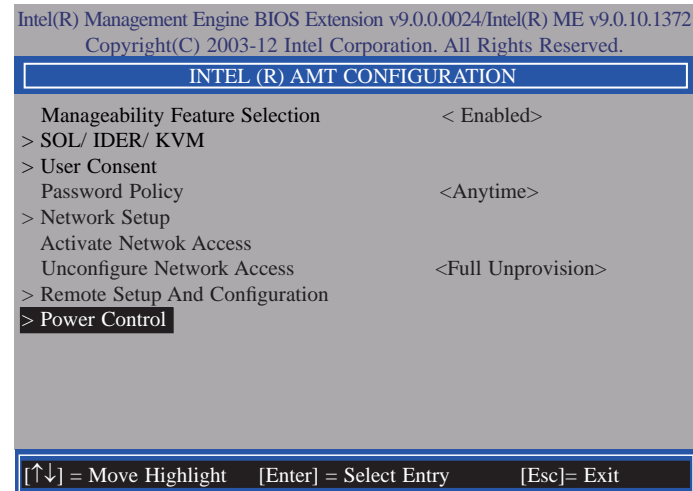

45. In the **Intel(R) AMT Power Control** menu, select **Intel(R) AMT ON in Host Sleep States** then press Enter. Select an option then press Enter.

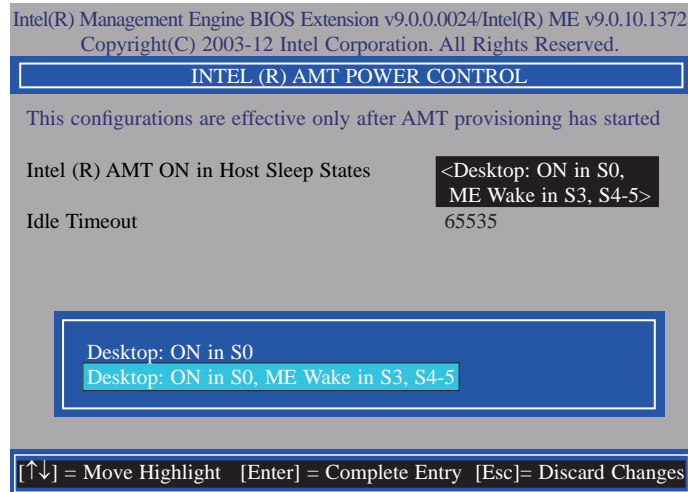

47. Select Previous Menu until you return to the **Main Menu**. Select **Exit** then press Enter. Type **Y** then press Enter.

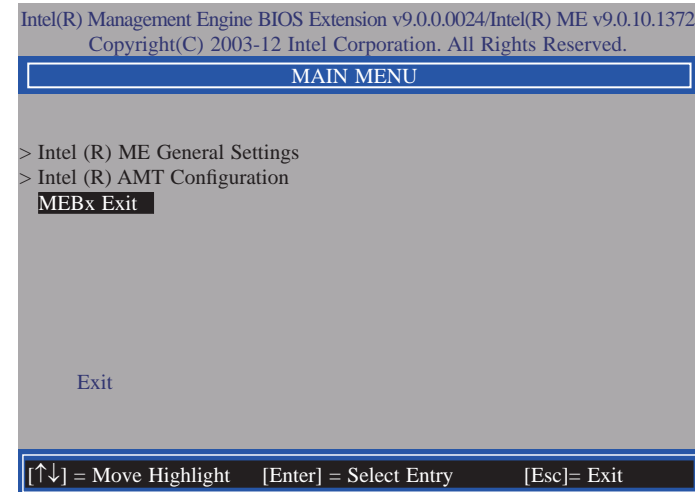

46. In the **Intel(R) AMT Power Control** menu, select **Idle Timeout** then press Enter. Enter the timeout value (1-65535).

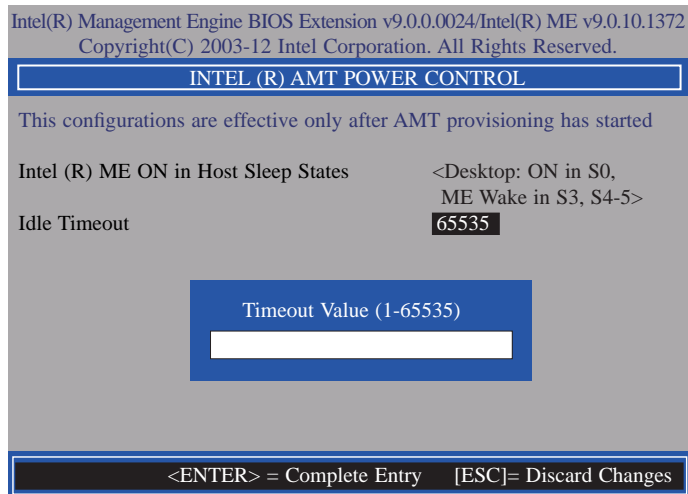

Appendix A - Watchdog Sample Code

;Software programming example:

```

;-----
;(1) Enter Super IO Configuration mode
;-----
MOV     DX,4EH
MOV     AL,87H
OUT     DX,AL
OUT     DX,AL

;-----
;(2) Configuration Logical Device 8, register CRF0/CRF1 (WDT Control/WDT
timer)
;-----
MOV     DX,4EH
MOV     AL,07H           ;Ready to Program Logical Device
OUT     DX,AL

MOV     DX,4FH
MOV     AL,08H           ;Select Logical Device 8
OUT     DX,AL

MOV     DX,4EH
MOV     AL, F1H           ;Select watchdog timer register
OUT     DX,AL

MOV     DX,4FH
MOV     AL,10H           ;Set watchdog timer value
OUT     DX,AL

MOV     DX,4EH
MOV     AL, F0H           ;Select watchdog Control Register
OUT     DX,AL

MOV     DX,4FH
MOV     AL,02H           ;Set Watchdog Control Value
OUT     DX,AL

;-----
;(1) Exit extended function mode
;-----
MOV     DX,4EH
MOV     AL,AAH
OUT     DX,AL

```

Appendix B - System Error Message

When the BIOS encounters an error that requires the user to correct something, either a beep code will sound or a message will be displayed in a box in the middle of the screen and the message, PRESS F1 TO CONTINUE, CTRL-ALT-ESC or DEL TO ENTER SETUP, will be shown in the information box at the bottom. Enter Setup to correct the error.

Error Messages

One or more of the following messages may be displayed if the BIOS detects an error during the POST. This list indicates the error messages for all Awards BIOSes:

CMOS BATTERY HAS FAILED

The CMOS battery is no longer functional. It should be replaced.



Important:

Danger of explosion if battery incorrectly replaced. Replace only with the same or equivalent type recommended by the manufacturer. Dispose of used batteries according to the battery manufacturer's instructions.

CMOS CHECKSUM ERROR

Checksum of CMOS is incorrect. This can indicate that CMOS has become corrupt. This error may have been caused by a weak battery. Check the battery and replace if necessary.

DISPLAY SWITCH IS SET INCORRECTLY

The display switch on the motherboard can be set to either monochrome or color. This indicates the switch is set to a different setting than indicated in Setup. Determine which setting is correct, either turn off the system and change the jumper or enter Setup and change the VIDEO selection.

FLOPPY DISK(S) fail (80)

Unable to reset floppy subsystem.

FLOPPY DISK(S) fail (40)

Floppy type mismatch.

Hard Disk(s) fail (80)

HDD reset failed.

Hard Disk(s) fail (40)

HDD controller diagnostics failed.

Hard Disk(s) fail (20)

HDD initialization error.

Hard Disk(s) fail (10)

Unable to recalibrate fixed disk.

Hard Disk(s) fail (08)

Sector Verify failed.

Keyboard is locked out - Unlock the key

The BIOS detects that the keyboard is locked. Keyboard controller is pulled low.

Keyboard error or no keyboard present

Cannot initialize the keyboard. Make sure the keyboard is attached correctly and no keys are being pressed during the boot.

Manufacturing POST loop

System will repeat POST procedure infinitely while the keyboard controller is pull low. This is also used for the M/B burn in test at the factory.

BIOS ROM checksum error - System halted

The checksum of ROM address F0000H-FFFFFFH is bad.

Memory test fail

The BIOS reports memory test fail if the memory has error(s).

Appendix C - Troubleshooting Checklist

Troubleshooting Checklist

This chapter of the manual is designed to help you with problems that you may encounter with your personal computer. To efficiently troubleshoot your system, treat each problem individually. This is to ensure an accurate diagnosis of the problem in case a problem has multiple causes.

Some of the most common things to check when you encounter problems while using your system are listed below.

1. The power switch of each peripheral device is turned on.
2. All cables and power cords are tightly connected.
3. The electrical outlet to which your peripheral devices are connected is working. Test the outlet by plugging in a lamp or other electrical device.
4. The monitor is turned on.
5. The display's brightness and contrast controls are adjusted properly.
6. All add-in boards in the expansion slots are seated securely.
7. Any add-in board you have installed is designed for your system and is set up correctly.

Monitor/Display

If the display screen remains dark after the system is turned on:

1. Make sure that the monitor's power switch is on.
2. Check that one end of the monitor's power cord is properly attached to the monitor and the other end is plugged into a working AC outlet. If necessary, try another outlet.
3. Check that the video input cable is properly attached to the monitor and the system's display adapter.
4. Adjust the brightness of the display by turning the monitor's brightness control knob.

The picture seems to be constantly moving.

1. The monitor has lost its vertical sync. Adjust the monitor's vertical sync.
2. Move away any objects, such as another monitor or fan, that may be creating a magnetic field around the display.
3. Make sure your video card's output frequencies are supported by this monitor.

The screen seems to be constantly wavering.

1. If the monitor is close to another monitor, the adjacent monitor may need to be turned off. Fluorescent lights adjacent to the monitor may also cause screen wavering.

Power Supply

When the computer is turned on, nothing happens.

1. Check that one end of the AC power cord is plugged into a live outlet and the other end properly plugged into the back of the system.
2. Make sure that the voltage selection switch on the back panel is set for the correct type of voltage you are using.
3. The power cord may have a "short" or "open". Inspect the cord and install a new one if necessary.

Floppy Drive

The computer cannot access the floppy drive.

1. The floppy diskette may not be formatted. Format the diskette and try again.
2. The diskette may be write-protected. Use a diskette that is not write-protected.
3. You may be writing to the wrong drive. Check the path statement to make sure you are writing to the targeted drive.
4. There is not enough space left on the diskette. Use another diskette with adequate storage space.

Hard Drive

Hard disk failure.

1. Make sure the correct drive type for the hard disk drive has been entered in the BIOS.
2. If the system is configured with two hard drives, make sure the bootable (first) hard drive is configured as Master and the second hard drive is configured as Slave. The master hard drive must have an active/bootable partition.

Excessively long formatting period.

If your hard drive takes an excessively long period of time to format, it is likely a cable connection problem. However, if your hard drive has a large capacity, it will take a longer time to format.

Serial Port

The serial device (modem, printer) doesn't output anything or is outputting garbled characters.

1. Make sure that the serial device's power is turned on and that the device is on-line.
2. Verify that the device is plugged into the correct serial port on the rear of the computer.
3. Verify that the attached serial device works by attaching it to a serial port that is working and configured correctly. If the serial device does not work, either the cable or the serial device has a problem. If the serial device works, the problem may be due to the onboard I/O or the address setting.
4. Make sure the COM settings and I/O address are configured correctly.

Keyboard

Nothing happens when a key on the keyboard was pressed.

1. Make sure the keyboard is properly connected.
2. Make sure there are no objects resting on the keyboard and that no keys are pressed during the booting process.

System Board

1. Make sure the add-in card is seated securely in the expansion slot. If the add-in card is loose, power off the system, re-install the card and power up the system.
2. Check the jumper settings to ensure that the jumpers are properly set.
3. Verify that all memory modules are seated securely into the memory sockets.
4. Make sure the memory modules are in the correct locations.
5. If the board fails to function, place the board on a flat surface and seat all socketed components. Gently press each component into the socket.
6. If you made changes to the BIOS settings, re-enter setup and load the BIOS defaults.