

WM343



► Features

- Wallmount Chassis for microATX motherboard
- Designed for ATM application
- Up to 2x 3.5"/2.5" SATA drive bays
- Optional optical drive bay
- Supports up to 4 expansion slots
- Color : no coating or black coating



microATX



► Panel

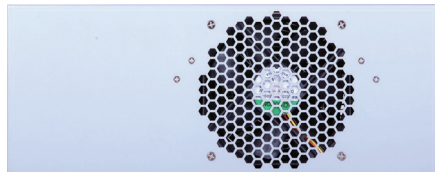

Front View



Rear View

► Dimensions

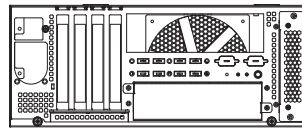

Rear View

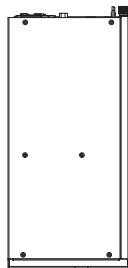

Left View

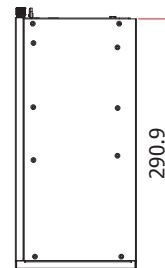
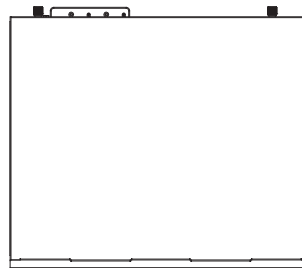

Right View

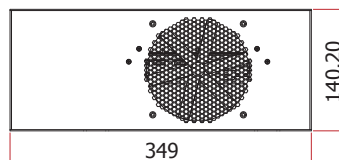

Front View

► Specifications

STORAGE	External	1 or 2 x 3.5"/2.5" SATA Drive Bays (1 x 3.5" SATA drive bay, by default) 1 x 5.25" Optical Drive Bay (available upon request)	
EXPANSION		4 x Expansion Slot	
LED	Indicators	1 x Power LED 1 x HDD LED	
I/O	Rear	2 x DB-9 Cutout 8 x USB 2.0 Cutout	
	Buttons	1 x Power Button	
COOLING	Fan	1 x System Fan	
POWER	Supply	Flex ATX 250W	
MECHANISM	Construction	Sheet Metal	
	Mounting	Wall Mount	
	Dimensions (W x H x D)	349mm x 140.2mm x 290.9mm (13.74" x 5.52" x 11.45")	
	Weight	7kg	
	Color	no coating or black coating	
ENVIRONMENT	Operating Temperature	0 to 50°C	
	Storage Temperature	0 to 60°C	
	Relative Humidity	5 to 95% RH (non-condensing)	
STANDARDS AND CERTIFICATIONS	Shock	Operating: 3G	Non-operating: 5G
	Vibration	Operating: Random 5~500Hz 0.5G	Non-operating: Sine 10~500Hz 1.5G
	Package Drop	ISTA Project 1A	
	Certification	CE, FCC Class A, RoHS	

▶ Wall Mounting

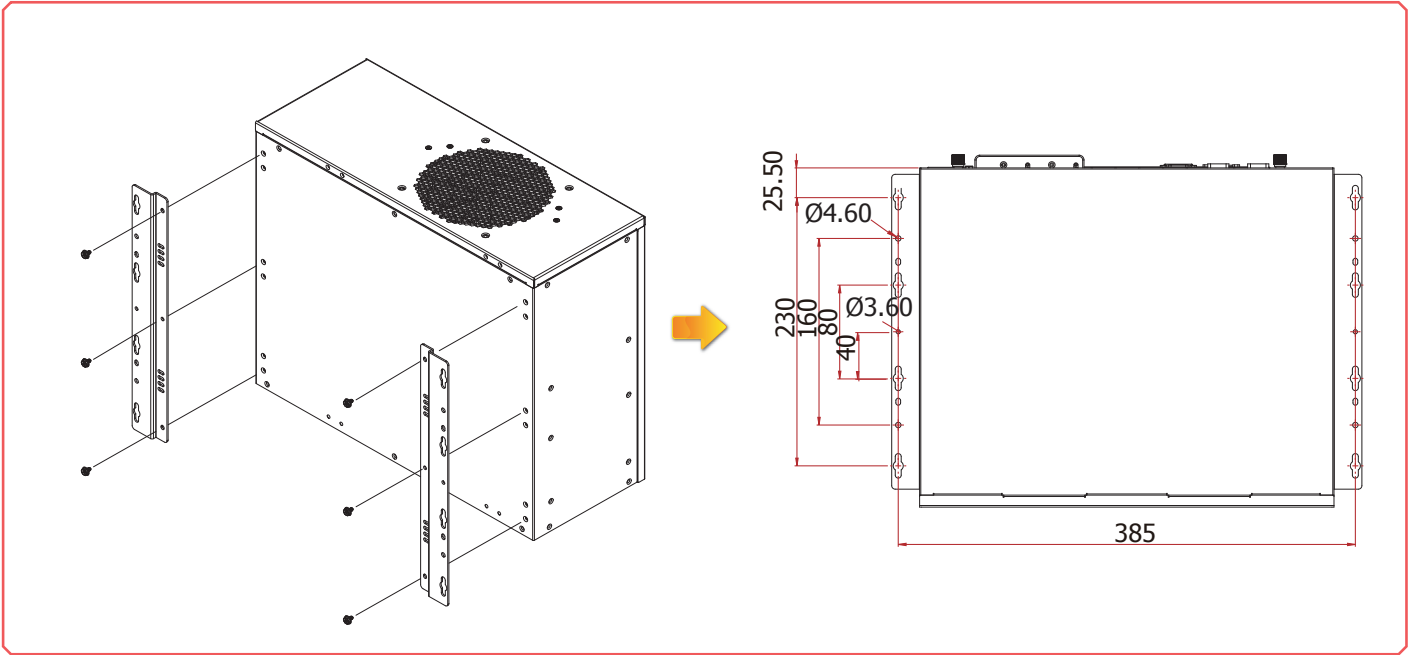

▶ Ordering Information

Model Name	Part Number	Description
WM343	7A0-WM3430-000G	WM343:uATX Chassis, no coating, W/Flex Power 250W F/G RoHS
WM343	7A0-WM3430-001G	WM343:uATX Chassis, no coating, W/O Power F/G RoHS
WM343	7A0-WM3430-100G	WM343:uATX Chassis, no coating, W/Flex Power 250W, 2 x 3.5" HDD bracket F/G RoHS
WM343	7A0-WM3430-200G	WM343:uATX Chassis, Black, W/Flex Power 250W F/G RoHS
WM343	7A0-WM3430-300G	WM343:uATX Chassis, Black, W/O Power F/G RoHS

▶ Optional Items

Optional Items	Part Number	Description
2.5" HDD/SSD Support	531-510360-000G	One F3 x5 Copper Standoff, RoHS (note: one bay needs 4 pcs of standoff)
Power Cord	785-PWRD	Power Cord, Standards (USA/EUR/CH), 1.8m, RoHS
Wall Mount	761-WM3410-000G	WM343/WM341 Wall Mount Kit, RoHS

▶ Packing List

• 1 WM343 Chassis
• 1 SATA Data Cable (Length: 650mm)
• 4 HDD Screws
• 1 250W PSU
• 1 System Fan