

SH960-CM236/QM170/HM170

**COM Express Basic Module
User's Manual**

Copyright

This publication contains information that is protected by copyright. No part of it may be reproduced in any form or by any means or used to make any transformation/adaptation without the prior written permission from the copyright holders.

This publication is provided for informational purposes only. The manufacturer makes no representations or warranties with respect to the contents or use of this manual and specifically disclaims any express or implied warranties of merchantability or fitness for any particular purpose. The user will assume the entire risk of the use or the results of the use of this document. Further, the manufacturer reserves the right to revise this publication and make changes to its contents at any time, without obligation to notify any person or entity of such revisions or changes.

Changes after the publication's first release will be based on the product's revision. The website will always provide the most updated information.

© 2018 All Rights Reserved.

Trademarks

Product names or trademarks appearing in this manual are for identification purpose only and are the properties of the respective owners.

COM Express Specification Reference

PICMG® COM Express Module™ Base Specification.

<http://www.picmg.org/>

FCC and DOC Statement on Class B

This equipment has been tested and found to comply with the limits for a Class B digital device, pursuant to Part 15 of the FCC rules. These limits are designed to provide reasonable protection against harmful interference when the equipment is operated in a residential installation. This equipment generates, uses and can radiate radio frequency energy and, if not installed and used in accordance with the instruction manual, may cause harmful interference to radio communications. However, there is no guarantee that interference will not occur in a particular installation. If this equipment does cause harmful interference to radio or television reception, which can be determined by turning the equipment off and on, the user is encouraged to try to correct the interference by one or more of the following measures:

- Reorient or relocate the receiving antenna.
- Increase the separation between the equipment and the receiver.
- Connect the equipment into an outlet on a circuit different from that to which the receiver is connected.
- Consult the dealer or an experienced radio TV technician for help.

Notice:

1. The changes or modifications not expressly approved by the party responsible for compliance could void the user's authority to operate the equipment.
2. Shielded interface cables must be used in order to comply with the emission limits.

Table of Contents

Trademarks	2	Chapter 5 - Supported Software	49
FCC and DOC Statement on Class B	2	Chapter 6 - RAID	64
About this Manual	4	Chapter 7 - Intel AMT Settings	68
Warranty	4	Appendix A - Troubleshooting.....	82
Static Electricity Precautions.....	4	Appendix B - Insyde BIOS Standard Status POST Code	84
About the Package	5		
Chapter 1 - Introduction	6		
Specifications	6		
Features	7		
Chapter 2 - Concept.....	8		
COM Express Module Standards	8		
Specification Comparison Table.....	9		
Chapter 3 - Hardware Installation.....	10		
Board Layout	10		
Block Diagram	10		
Mechanical Diagram.....	11		
System Memory	12		
Installing the DIMM Module	12		
Connectors.....	13		
CPU Fan Connector.....	13		
COM Express Connectors	14		
COM Express Connectors Signal Description	16		
Standby Power LED	32		
Cooling Option	32		
Installing SH960-CM236/QM170/HM170 onto a Carrier Board	33		
Chapter 4 - BIOS Setup	35		
Overview	35		
Insyde BIOS Setup Utility.....	36		
Main	36		
Advanced	36		
Security	43		
Boot	45		
Exit	47		
Updating the BIOS	48		

About this Manual

This manual can be downloaded from the website, or acquired as an electronic file included in the optional CD/DVD. The manual is subject to change and update without notice, and may be based on editions that do not resemble your actual products. Please visit our website or contact our sales representatives for the latest editions.

Warranty

1. Warranty does not cover damages or failures that arised from misuse of the product, inability to use the product, unauthorized replacement or alteration of components and product specifications.
2. The warranty is void if the product has been subjected to physical abuse, improper installation, modification, accidents or unauthorized repair of the product.
3. Unless otherwise instructed in this user's manual, the user may not, under any circumstances, attempt to perform service, adjustments or repairs on the product, whether in or out of warranty. It must be returned to the purchase point, factory or authorized service agency for all such work.
4. We will not be liable for any indirect, special, incidental or consequential damages to the product that has been modified or altered.

Static Electricity Precautions

It is quite easy to inadvertently damage your PC, system board, components or devices even before installing them in your system unit. Static electrical discharge can damage computer components without causing any signs of physical damage. You must take extra care in handling them to ensure against electrostatic build-up.

1. To prevent electrostatic build-up, leave the system board in its anti-static bag until you are ready to install it.
2. Wear an antistatic wrist strap.
3. Do all preparation work on a static-free surface.
4. Hold the device only by its edges. Be careful not to touch any of the components, contacts or connections.
5. Avoid touching the pins or contacts on all modules and connectors. Hold modules or connectors by their ends.



Important:

Electrostatic discharge (ESD) can damage your processor, disk drive and other components. Perform the upgrade instruction procedures described at an ESD workstation only. If such a station is not available, you can provide some ESD protection by wearing an antistatic wrist strap and attaching it to a metal part of the system chassis. If a wrist strap is unavailable, establish and maintain contact with the system chassis throughout any procedures requiring ESD protection.

Safety Measures

To avoid damage to the system:

- Use the correct AC input voltage range.

To reduce the risk of electric shock:

- Unplug the power cord before removing the system chassis cover for installation or servicing. After installation or servicing, cover the system chassis before plugging the power cord.

About the Package

The package contains the following items. If any of these items are missing or damaged, please contact your dealer or sales representative for assistance.

- One SH960 board
- One Cooler (Height: 36.58mm)

Optional Items

- COM332-B carrier board kit
- Heat spreader (Height: 11mm)

The board and accessories in the package may not come similar to the information listed above. This may differ in accordance with the sales region or models in which it was sold. For more information about the standard package in your region, please contact your dealer or sales representative.

Before Using the System Board

Before using the system board, prepare basic system components.

If you are installing the system board in a new system, you will need at least the following internal components.

- Memory module
- Storage devices such as hard disk drive, CD-ROM, etc.

You will also need external system peripherals you intend to use, which will normally include a keyboard, a mouse and a video display monitor.

Chapter 1 - Introduction

Specifications

System	Processor	6th Generation Intel Processors, BGA 1440 Intel® Xeon® E3-1515M v5 Processor, Quad Core, 8M Cache, 2.8GHz (3.7GHz), 45W (Support ECC) Intel® Core™ i7-6820EQ, Quad Core, 8M Cache, 2.8GHz (3.5GHz), 45W Intel® Core™ i7-6822EQ, Quad Core, 8M Cache, 2.0GHz (2.8GHz), 25W Intel® Core™ i5-6440EQ, Quad Core, 6M Cache, 2.7GHz (3.4GHz), 45W Intel® Core™ i5-6442EQ, Quad Core, 6M Cache, 1.9GHz (2.7GHz), 25W Intel® Core™ i3-6100E, Dual Core, 3M Cache, 2.7GHz, 35W (Support ECC) Intel® Core™ i3-6102E, Dual Core, 3M Cache, 1.9GHz, 25W (Support ECC) Intel® Celeron® Processor G3900E, Dual Core, 2M Cache, 2.4GHz, 35W (Support ECC) Intel® Celeron® Processor G3902E, Dual Core, 2M Cache, 1.6GHz, 25W (Support ECC)
	Chipset	Intel® CM236 (SH960-CM236) (Support ECC) Intel® QM170 (SH960-QM170) Intel® HM170 (SH960-HM170)
	Memory	Two 260-pin SODIMM up to 32GB [†] Dual Channel DDR4 2133MHz
	BIOS	Insyde SPI 128Mbit
	Graphics	Controller Intel® HD Graphics GT Series Feature OpenGL up to 4.4, DirectX 12, OpenCL 2.1 HW Decode: AVC/H.264, MPEG2, VC1/WMV9, JPEG/MJPEG, HEVC/H265, VP8, VP9 HW Encode: AVC/H.264, MPEG2, JPEG, HEVC/H265, VP8, VP9 Display 1 x VGA/DDI (DDI available upon request) 1 x LVDS/eDP (eDP available upon request) 2 x DDI (HDMI/DVI/DP++) VGA: resolution up to 1920x1200@60Hz LVDS: dual channel 24-bit, resolution up to 1920x1200 @ 60Hz HDMI: resolution up to 4096x2160 @ 24Hz or 2560x1600 @ 60Hz DVI: resolution up to 1920x1200 @ 60Hz DP++/eDP: resolution up to 4096x2304 @ 60Hz Triple Displays VGA+LVDS+DDI or VGA+ DDI1+DDI2 eDP + 2 DDI (available upon request)
Expansion	Interface 1 x PCIe x16 or 2 x PCIe x8 (Gen 3) 8 x PCIe x1 or 2 x PCIe x4 or 4 x PCIe x2 (Gen 3) 1 x LPC 1 x I ² C 1 x SMBus 2 x serial (TX/RX)	

Audio	Interface	HD Audio
Ethernet	Controller	1 x Intel® I219LM PHY with iAMT11.0 PCIe (10/100/1000Mbps) [‡]
I/O	USB	4 x USB 3.0 8 x USB 2.0
	SATA	4 x SATA 3.0 (up to 6Gb/s) RAID 0/1/5/10
	DIO	1 x 8-bit DIO (Default 4 input and 4 output)
WatchDog Timer	Output & Interval	System Reset, Programmable via Software from 1 to 255 Seconds
Security	TPM	Available Upon Request
Power	Type	12V, 5VSB, VCC_RTC (ATX mode) 12V, VCC_RTC (AT mode)
	Consumption	Typical: I7-6820EQ: 12V @ 2.39A (28.62Watt) Max.: I7-6820EQ: 12V @ 5.84A (70.10Watt)
OS Support		Windows 8.1 64-bit Windows 7 (WES7) 32/64-bit Windows 10 IoT Enterprise 64-bit Debian 8 (with VESA graphic driver) CentOS 7 (with VESA graphic driver) Ubuntu 15.10 (Intel graphic driver available)
Environment	Temperature	Operating : 0 to 60°C : -45 to 80°C -40 to 85°C (with heat spreader) Storage: -40 to 85°C
	Humidity	Operating: 5 to 90% RH Storage: 5 to 90% RH
	MTBF	663,394hrs @ 25°C; 334,612 hrs @ 45°C; 193,307 hrs @ 60°C excluding accessories Calculation Model: Telcordia Issue 2, Method Case 3 Environment: GB, GC – Ground Benign, Controlled
Mechanical	Dimensions	COM Express® Basic 95mm (3.74") x 125mm (4.9")
	Compliance	PICMG COM Express® R2.1, Type 6

* Intel® Xeon® E3-1515M v5 can only be paired with the Intel® CM236 Chipset.

† The maximum memory speed supported differs by SKU.

‡ Intel Active Management Technology (Intel® AMT) is not available for Core™ i3 and Celeron® processors or HM170 chipset.

Features

• Watchdog Timer

The Watchdog Timer function allows your application to regularly “clear” the system at the set time interval. If the system hangs or fails to function, it will reset at the set time interval so that your system will continue to operate.

• DDR4

DDR4 delivers increased system bandwidth and improves performance. The advantages of DDR4 provide an extended battery life and improve the performance at a lower power than DDR3/DDR2.

• Graphics

The integrated Intel® HD graphics and engine delivers an excellent blend of graphics performance and features. And with the Intel® Iris Pro Graphics which is equipped in the Intel® Xeon® processor, the system can be scaled up to meet the requirements of performance-demanding video applications.

• Serial ATA

The system supports multiple SATA 3.0 (up to 6Gb/s) ports and allows for different configurations of RAID levels to meet various requirements for data redundancy and performance.

• Gigabit LAN

The Intel® I219LM Gigabit LAN PHY controller features up to 1Gbps data transmission with support for Intel® Active Management Technology. It provides remote maintenance and manageability for networked computing assets in an enterprise environment.

• USB

The system board supports the new USB 3.0. It is capable of running at a maximum transmission speed of up to 5 Gbit/s (625 MB/s) and is faster than USB 2.0 (480 Mbit/s, or 60 MB/s) and USB 1.1 (12Mb/s). USB 3.0 reduces the time required for data transmission, reduces power consumption, and is backward compatible with USB 2.0. It is a marked improvement in device transfer speeds between your computer and a wide range of simultaneously accessible external Plug and Play peripherals.

Chapter 2 - Concept

COM Express Module Standards

The figure below shows the dimensions of the different types of COM Express modules.

SH960-CM236/QM170/HM170 is a COM Express Basic module. The dimension is 95mm x 125mm.

- Common for all Form Factors
- Extended only
- Basic only
- Compact only
- Compact and Basic only
- Mini only

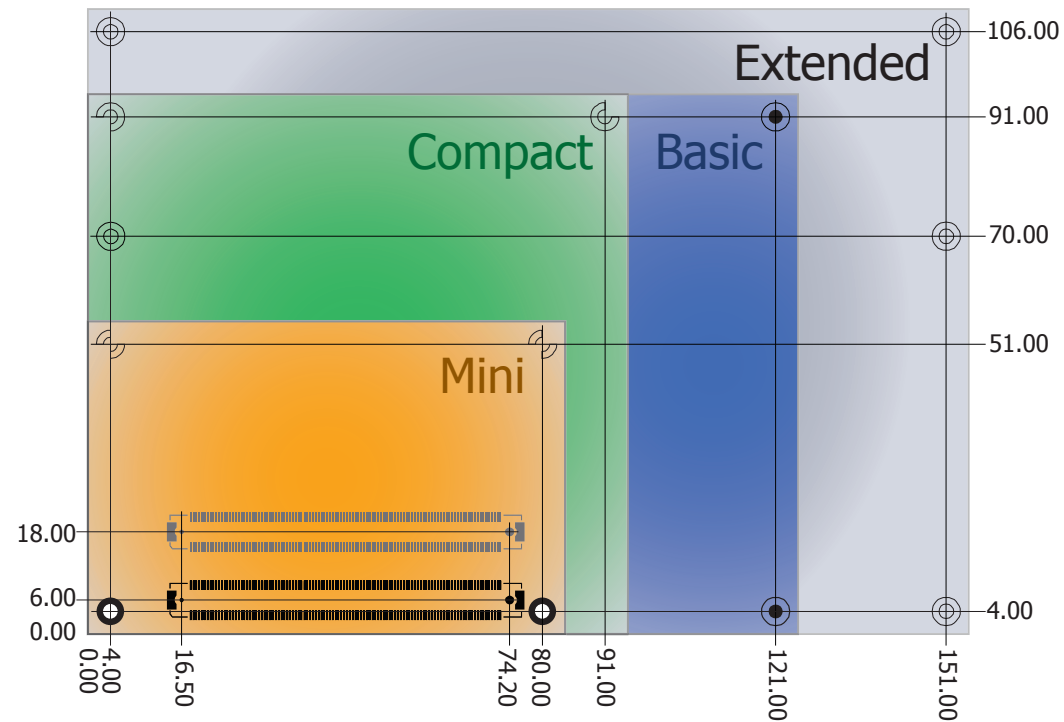

Note:

Throughout this guide the SH960-CM236/QM170/HM170 may be referred to as the SH960 COMe board.

Specification Comparison Table

The table below shows the COM Express standard specifications and the corresponding specifications supported on the SH960-CM236/QM170/HM170 module.

Module Pin-out - Required and Optional Features A-B Connector.

Connector	Feature	COM Express Module Base Specification Type 6 (No IDE or PCI, add DDI+ USB3) Min / Max	DFI SH960 Type 6
A-B	System I/O		
A-B	PCI Express Lanes 0 - 5	1 / 6	6
A-B	LVDS Channel A	0 / 1	1
A-B	LVDS Channel B	0 / 1	1
A-B	eDP on LVDS CH A pins	0 / 1	1
A-B	VGA Port	0 / 1	1
A-B	TV-Out	NA	NA
A-B	DDI 0	NA	NA
A-B ⁵	Serial Ports 1 - 2	0 / 2	2
A-B	CAN interface on SER1	0 / 1	0
A-B	SATA / SAS Ports	1 / 4	4
A-B	AC'97 / HDA Digital Interface	0 / 1	1
A-B	USB 2.0 Ports	4 / 8	8
A-B	USB Client	0 / 1	0
A-B	USB 3.0 Ports	NA	NA
A-B	LAN Port 0	1 / 1	1
A-B	Express Card Support	1 / 2	2
A-B	LPC Bus	1 / 1	1
A-B	SPI	1 / 2	1
A-B	System Management		
A-B ⁶	SDIO (muxed on GPIO)	0 / 1	NA
A-B ⁶	General Purpose I/O	8 / 8	8
A-B	SMBus	1 / 1	1
A-B	I2C	1 / 1	1
A-B	Watchdog Timer	0 / 1	1
A-B	Speaker Out	1 / 1	1
A-B	External BIOS ROM Support	0 / 2	1
A-B	Reset Functions	1 / 1	1

- 5 Indicates 12V-tolerant features on former VCC_12V signals.
- 6 Cells in the connected columns spanning rows provide a rough approximation of features sharing connector pins.

Connector	Feature	COM Express Module Base Specification Type 6 (No IDE or PCI, add DDI+ USB3) Min / Max	DFI SH960 Type 6
A-B	Power Management		
A-B	Thermal Protection	0 / 1	1
A-B	Battery Low Alarm	0 / 1	1
A-B	Suspend/Wake Signals	0 / 3	2
A-B	Power Button Support	1 / 1	1
A-B	Power Good	1 / 1	1
A-B	VCC_5V_SBY Contacts	4 / 4	4
A-B ⁵	Sleep Input	0 / 1	1
A-B ⁵	Lid Input	0 / 1	1
A-B ⁵	Fan Control Signals	0 / 2	1
A-B	Trusted Platform Modules	0 / 1	1 (optional)
A-B	Power		
A-B	VCC_12V Contacts	12 / 12	12

Module Pin-out - Required and Optional Features C-D Connector.

Connector	Feature	COM Express Module Base Specification Type 6 (No IDE or PCI, add DDI+ USB3) Min / Max	DFI SH960 Type 6
C-D	System I/O		
C-D ⁶	PCI Express Lanes 16 - 31	0 / 16	16
	PCI Express Graphics (PEG)	0 / 1	1
	Muxed SDVO Channels 1 - 2	NA	NA
	PCI Express Lanes 6 - 15	0 / 2	2
C-D ⁶	PCI Bus - 32 Bit	NA	NA
	PATA Port	NA	NA
	LAN Ports 1 - 2	NA	NA
	DDIs 1 - 3	0 / 3	3 (DDI3 option)
	USB 3.0 Ports	0 / 4	4
C-D	Power		
C-D	VCC_12V Contacts	12 / 12	12

Chapter 3 - Hardware Installation

Board Layout

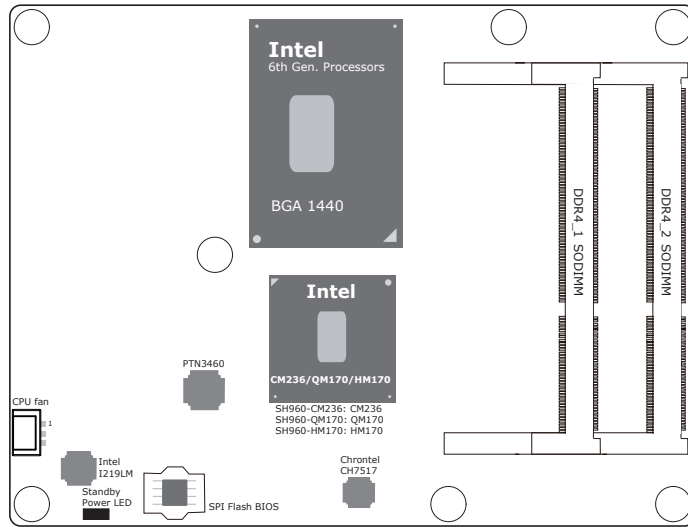

Top View

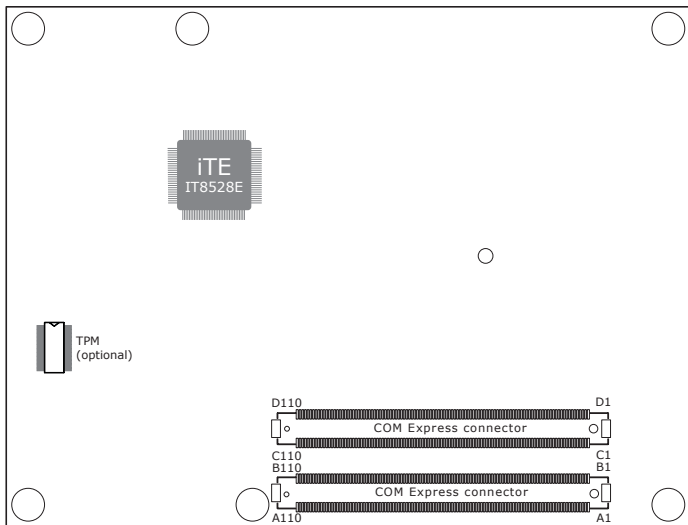

Bottom View

Block Diagram

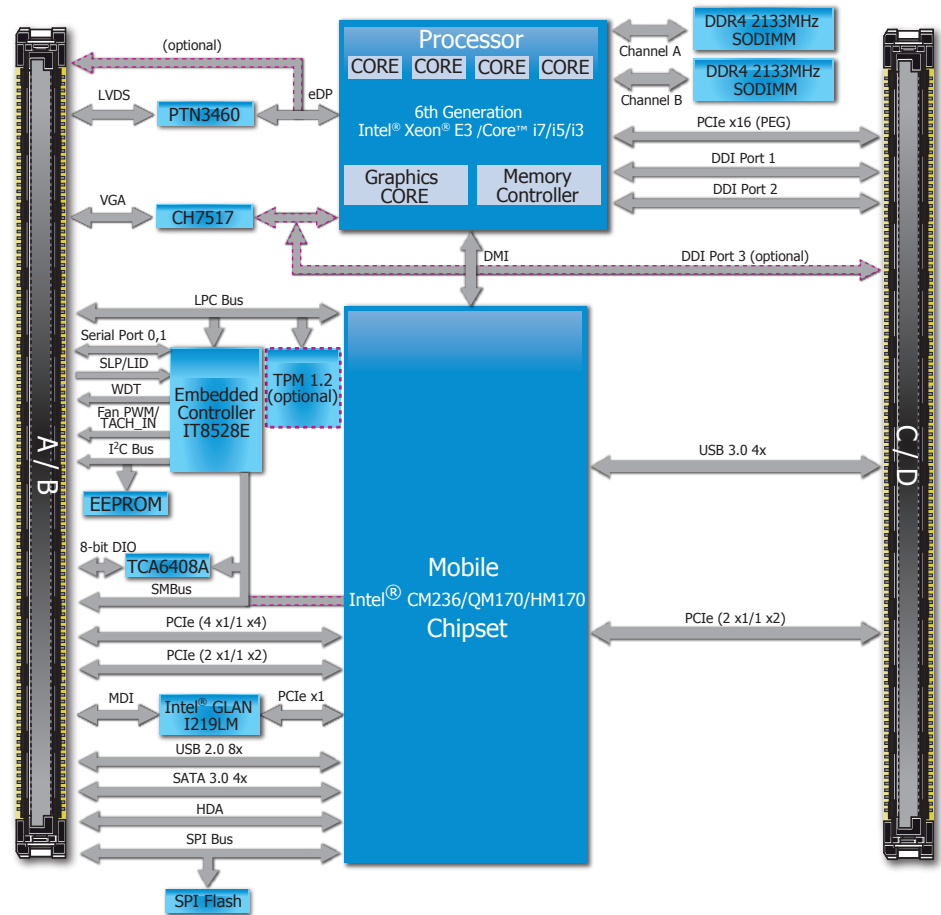

Mechanical Diagram

Heat Sink and Fan

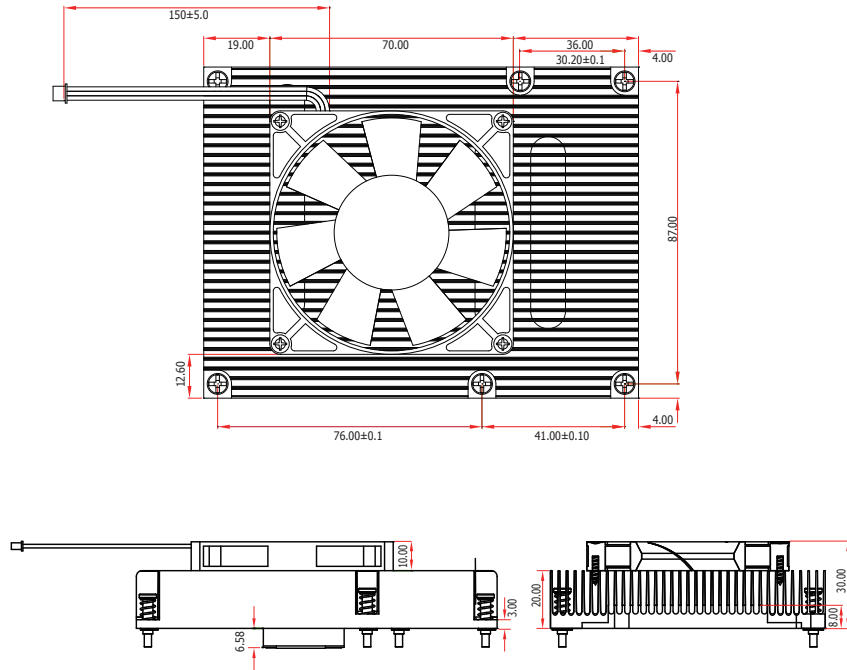

SH960-CM236/QM170/HM170 Module

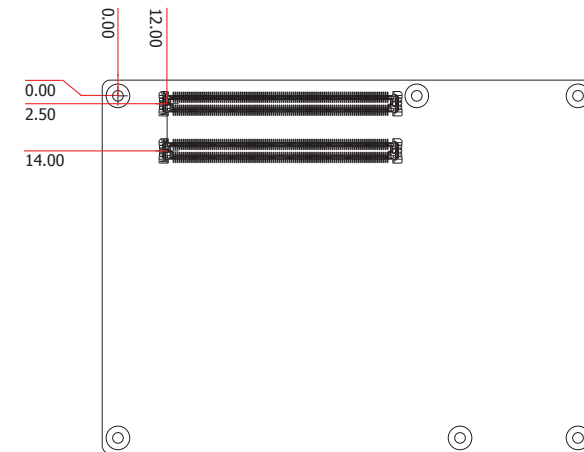
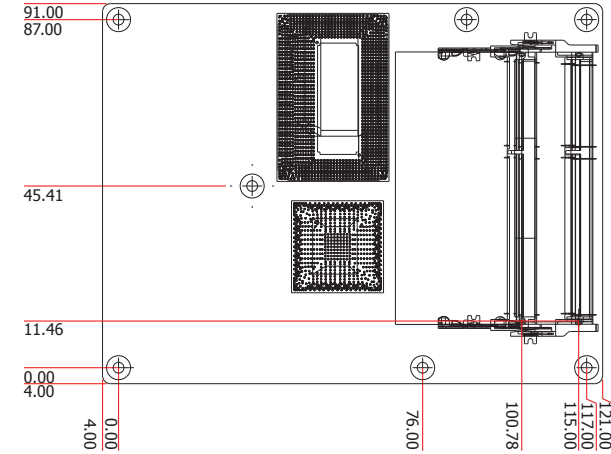

**Important:**

Electrostatic discharge (ESD) can damage your board, processor, disk drives, add-in boards, and other components. Perform installation procedures at an ESD workstation only. If such a station is not available, you can provide some ESD protection by wearing an antistatic wrist strap and attaching it to a metal part of the system chassis. If a wrist strap is unavailable, establish and maintain contact with the system chassis throughout any procedures requiring ESD protection.

System Memory

The system board is equipped with two 260-pin SODIMM sockets that support non-ECC DDR4 (1.2V) memory modules.

**Important:**

When the Standby Power LED lit red, it indicates that there is power on the board. Power-off the PC then unplug the power cord prior to installing any devices. Failure to do so will cause severe damage to the board and components.

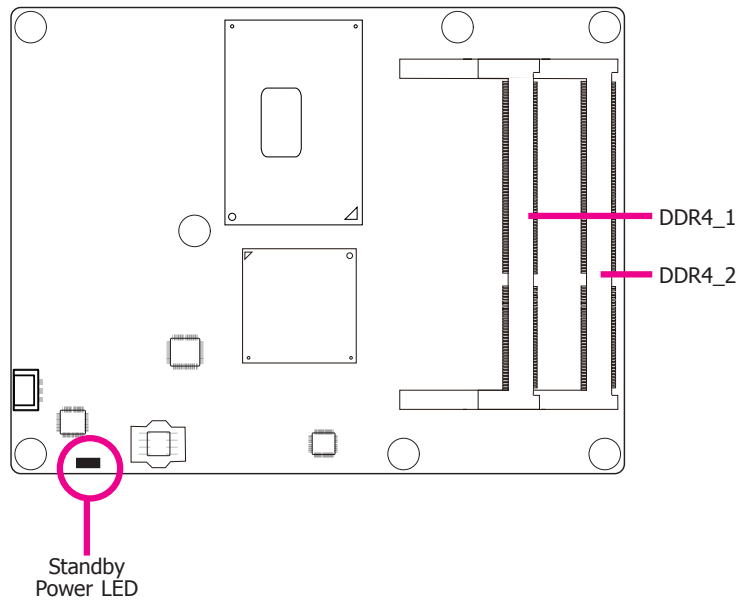

Installing the DIMM Module

**Note:**

The system board used in the following illustrations may not resemble the actual one. These illustrations are for reference only.

1. Check to see if the module is a non-ECC DDR4 SODIMM module.
2. Make sure the PC and all other peripheral devices connected to it has been powered down.
3. Disconnect all power cords and cables.
4. Locate the SODIMM socket on the system board.
5. Note the key on the socket. The key ensures that the module can be plugged into the socket in only one direction.

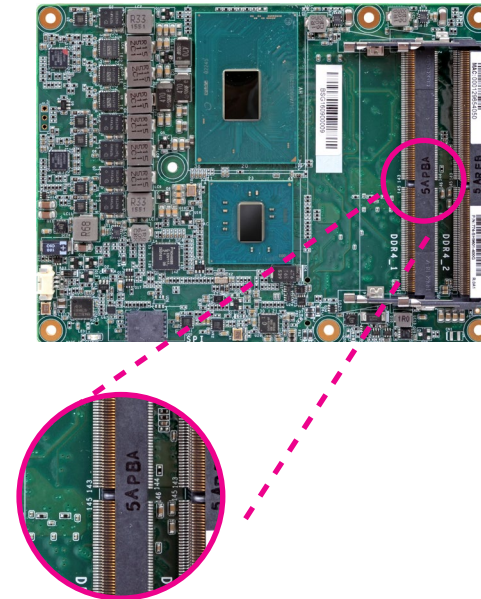

- Grasp the memory module by its edges and align the module key with the memory socket key. Grasp the module by its edges and align the memory's notch with the socket's notch; then insert the memory into the socket at an angle and push it down until you feel a click.

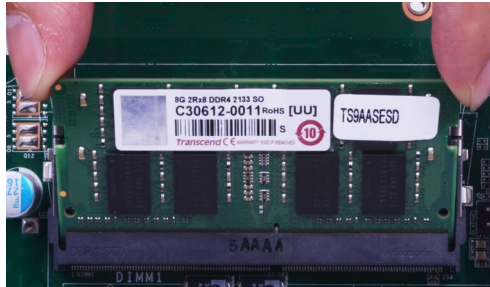

Connectors

CPU Fan Connector

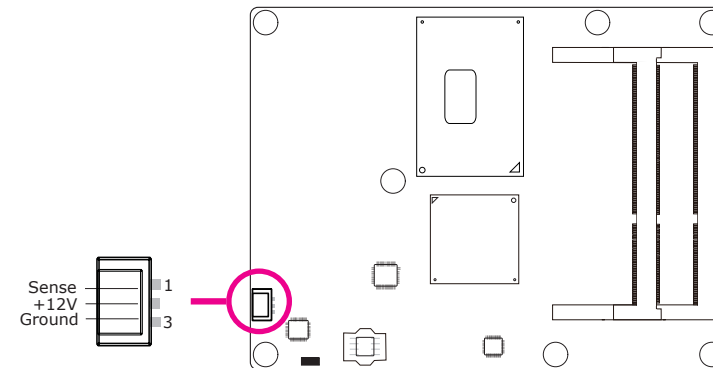

Connect the CPU fan's cable connector to the CPU fan connector on the board. The cooling fan will provide adequate airflow throughout the chassis to prevent overheating the CPU and board components.

BIOS Setting

"PC Health Status" submenu in the Advanced menu of the BIOS will display the current speed of the cooling fan. Refer to Chapter 4 for more information.

COM Express Connectors

The COM Express connectors are used to interface the SH960 COMe board with a carrier board. Connect the COM Express connectors (located on the solder side of the board) to the COM Express connectors on the carrier board.

Refer to the “Installing SH960-CM236/QM170/HM170 onto a Carrier Board” section for more information.

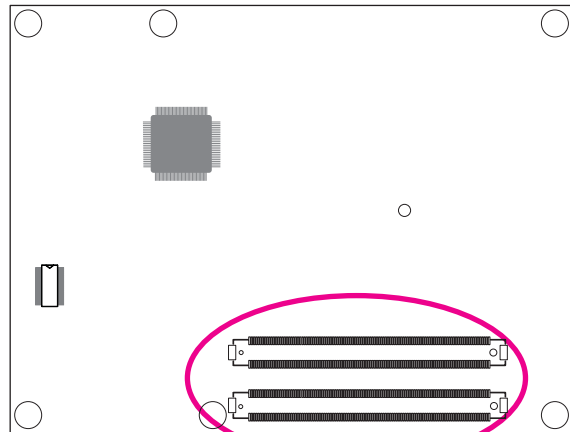

COM Express Connectors

Refer to the following pages for the pin functions of these connectors.

Pin	Row A	Row B	Row C	Row D
1	GND(FIXED)	GND(FIXED)	GND(FIXED)	GND(FIXED)
2	GBE0_MDI3-	GBE0_ACT#	GND	GND
3	GBE0_MDI3+	LPC_FRAME#	USB_SSRX0-	USB_SSTX0-
4	GBE0_LINK100#	LPC_AD0	USB_SSRX0+	USB_SSTX0+
5	GBE0_LINK1000#	LPC_AD1	GND	GND
6	GBE0_MDI2-	LPC_AD2	USB_SSRX1-	USB_SSTX1-
7	GBE0_MDI2+	LPC_AD3	USB_SSRX1+	USB_SSTX1+
8	GBE0_LINK#	LPC_DRQ0#	GND	GND
9	GBE0_MDI1-	LPC_DRQ1#	USB_SSRX2-	USB_SSTX2-
10	GBE0_MDI1+	LPC_CLK	USB_SSRX2+	USB_SSTX2+
11	GND(FIXED)	GND(FIXED)	GND(FIXED)	GND(FIXED)
12	GBE0_MDI0-	PWRBTN#	USB_SSRX3-	USB_SSTX3-
13	GBE0_MDI0+	SMB_CK	USB_SSRX3+	USB_SSTX3+
14	GBE0_CTREF	SMB_DAT	GND	GND
15	SUS_S3#	SMB_ALERT#	DDI1_PAIR6+	DDI1_CTRLCLK_AUX+
16	SATA0_TX+	SATA1_TX+	DDI1_PAIR6-	DDI1_CTRLDATA_AUX-
17	SATA0_TX-	SATA1_TX-	RSVD ¹⁹	RSVD ¹⁹
18	SUS_S4#	SUS_STAT#	RSVD ¹⁹	RSVD ¹⁹
19	SATA0_RX+	SATA1_RX+	PCIE_RX6+	PCIE_TX6+
20	SATA0_RX-	SATA1_RX-	PCIE_RX6-	PCIE_TX6-
21	GND(FIXED)	GND(FIXED)	GND(FIXED)	GND(FIXED)
22	SATA2_TX+	SATA3_TX+	PCIE_RX7+	PCIE_TX7+
23	SATA2_TX-	SATA3_TX-	PCIE_RX7-	PCIE_TX7-
24	SUS_S5#	PWR_OK	DDI1_HPD	RSVD ¹⁹
25	SATA2_RX+	SATA3_RX+	DDI1_PAIR4+	RSVD ¹⁹
26	SATA2_RX-	SATA3_RX-	DDI1_PAIR4-	DDI1_PAIR0+
27	BATLOW#	WDT	RSVD ¹⁹	DDI1_PAIR0-
28	(S)ATA_ACT#	AC/HDA_SDIN2	RSVD ¹⁹	RSVD ¹⁹
29	AC/HDA_SYNC	AC/HDA_SDIN1	DDI1_PAIR5+	DDI1_PAIR1+
30	AC/HDA_RST#	AC/HDA_SDIN0	DDI1_PAIR5-	DDI1_PAIR1-
31	GND(FIXED)	GND(FIXED)	GND(FIXED)	GND(FIXED)
32	AC/HDA_BITCLK	SPKR	DDI2_CTRLCLK_AUX+	DDI1_PAIR2+
33	AC/HDA_SDOOUT	I2C_CK	DDI2_CTRLDATA_AUX-	DDI1_PAIR2-
34	BIOS_DIS0#	I2C_DAT	DDI2_DDC_AUX_SEL	DDI1_DDC_AUX_SEL
35	THRMTRIP#	THRM#	RSVD ¹⁹	RSVD ¹⁹
36	USB6-	USB7-	DDI3_CTRLCLK_AUX+	DDI1_PAIR3+
37	USB6+	USB7+	DDI3_CTRLDATA_AUX-	DDI1_PAIR3-
38	USB_6_7_OC#	USB_4_5_OC#	DDI3_DDC_AUX_SEL	RSVD ¹⁹
39	USB4-	USB5-	DDI3_PAIR0+	DDI2_PAIR0+
40	USB4+	USB5+	DDI3_PAIR0-	DDI2_PAIR0-
41	GND(FIXED)	GND(FIXED)	GND(FIXED)	GND(FIXED)

COM Express Connectors

Pin	Row A	Row B	Row C	Row D
42	USB2-	USB3-	DDI3 PAIR1+	DDI2 PAIR1+
43	USB2+	USB3+	DDI3 PAIR1-	DDI2 PAIR1-
44	USB 2 3 OC#	USB 0 1 OC#	DDI3 HPD	DDI2 HPD
45	USB0-	USB1-	RSVD ¹⁹	RSVD ¹⁹
46	USB0+	USB1+	DDI3 PAIR2+	DDI2 PAIR2+
47	VCC_RTC	EXCD1_PERST#	DDI3 PAIR2-	DDI2 PAIR2-
48	EXCD0_PERST#	EXCD1_CPPE#	RSVD ¹⁹	RSVD ¹⁹
49	EXCD0_CPPE#	SYS RESET#	DDI3 PAIR3+	DDI2 PAIR3+
50	LPC_SERIRQ	CB_RESET#	DDI3 PAIR3-	DDI2 PAIR3-
51	GND(FIXED)	GND(FIXED)	GND(FIXED)	GND(FIXED)
52	PCIE_TX5+	PCIE_RX5+	PEG_RX0+	PEG_TX0+
53	PCIE_TX5-	PCIE_RX5-	PEG_RX0-	PEG_TX0-
54	GPI0	GPO1	TYPE0#	PEG_LANE RV#
55	PCIE_TX4+	PCIE_RX4+	PEG_RX1+	PEG_TX1+
56	PCIE_TX4-	PCIE_RX4-	PEG_RX1-	PEG_TX1-
57	GND	GPO2	TYPE1#	TYPE2#
58	PCIE_TX3+	PCIE_RX3+	PEG_RX2+	PEG_TX2+
59	PCIE_TX3-	PCIE_RX3-	PEG_RX2-	PEG_TX2-
60	GND(FIXED)	GND(FIXED)	GND(FIXED)	GND(FIXED)
61	PCIE_TX2+	PCIE_RX2+	PEG_RX3+	PEG_TX3+
62	PCIE_TX2-	PCIE_RX2-	PEG_RX3-	PEG_TX3-
63	GPI1	GPO3	RSVD ¹⁹	RSVD ¹⁹
64	PCIE_TX1+	PCIE_RX1+	RSVD ¹⁹	RSVD ¹⁹
65	PCIE_TX1-	PCIE_RX1-	PEG_RX4+	PEG_TX4+
66	GND	WAKE0#	PEG_RX4-	PEG_TX4-
67	GPI2	WAKE1#	RSVD ¹⁹	GND
68	PCIE_TX0+	PCIE_RX0+	PEG_RX5+	PEG_TX5+
69	PCIE_TX0-	PCIE_RX0-	PEG_RX5-	PEG_TX5-
70	GND(FIXED)	GND(FIXED)	GND(FIXED)	GND(FIXED)
71	LVDS A0+	LVDS B0+	PEG_RX6+	PEG_TX6+
72	LVDS A0-	LVDS B0-	PEG_RX6-	PEG_TX6-
73	LVDS A1+	LVDS B1+	GND	GND
74	LVDS A1-	LVDS B1-	PEG_RX7+	PEG_TX7+
75	LVDS A2+	LVDS B2+	PEG_RX7-	PEG_TX7-
76	LVDS A2-	LVDS B2-	GND	GND
77	LVDS VDD_EN	LVDS B3+	RSVD ¹⁹	RSVD ¹⁹
78	LVDS A3+	LVDS B3-	PEG_RX8+	PEG_TX8+
79	LVDS A3-	LVDS BKLT_EN	PEG_RX8-	PEG_TX8-
80	GND(FIXED)	GND(FIXED)	GND(FIXED)	GND(FIXED)
81	LVDS A CK+	LVDS B CK+	PEG_RX9+	PEG_TX9+
82	LVDS A CK-	LVDS B CK-	PEG_RX9-	PEG_TX9-
83	LVDS I2C CK	LVDS BKLT_CTRL	RSVD ¹⁹	RSVD ¹⁹
84	LVDS I2C DAT	VCC 5V_SBY	GND	GND
85	GPI3	VCC 5V_SBY	PEG_RX10+	PEG_TX10+
86	RSVD ¹⁹	VCC 5V_SBY	PEG_RX10-	PEG_TX10-
87	eDP HPD	VCC 5V_SBY	GND	GND
88	PCIE_CLK_REF+	BIOS_DIS1#	PEG_RX11+	PEG_TX11+
89	PCIE_CLK_REF-	VGA_RED	PEG_RX11-	PEG_TX11-
90	GND(FIXED)	GND(FIXED)	GND(FIXED)	GND(FIXED)

Pin	Row A	Row B	Row C	Row D
91	SPI POWER	VGA GRN	PEG_RX12+	PEG_TX12+
92	SPI MISO	VGA BLU	PEG_RX12-	PEG_TX12-
93	GPO0	VGA HSYNC	GND	GND
94	SPI_CLK	VGA_VSYNC	PEG_RX13+	PEG_TX13+
95	SPI_MOSI	VGA_I2C_CLK	PEG_RX13-	PEG_TX13-
96	TPM_PP	VGA_I2C_DAT	GND	GND
97	TYPE10#	SPI_CS#	RSVD ¹⁹	RSVD ¹⁹
98	SER0_TX	RSVD ¹⁹	PEG_RX14+	PEG_TX14+
99	SER0_RX	RSVD ¹⁹	PEG_RX14-	PEG_TX14-
100	GND(FIXED)	GND(FIXED)	GND(FIXED)	GND(FIXED)
101	SER1_TX	FAN_PWMOUT	PEG_RX15+	PEG_TX15+
102	SER1_RX	FAN_TACHIN	PEG_RX15-	PEG_TX15-
103	LID#	SLEEP#	GND	GND
104	VCC_12V	VCC_12V	VCC_12V	VCC_12V
105	VCC_12V	VCC_12V	VCC_12V	VCC_12V
106	VCC_12V	VCC_12V	VCC_12V	VCC_12V
107	VCC_12V	VCC_12V	VCC_12V	VCC_12V
108	VCC_12V	VCC_12V	VCC_12V	VCC_12V
109	VCC_12V	VCC_12V	VCC_12V	VCC_12V
110	GND(FIXED)	GND(FIXED)	GND(FIXED)	GND(FIXED)

COM Express Connectors Signal Description

Pin Types I Input to the Module O Output from the Module I/O Bi-directional input / output signal OD Open drain output RSVD pins are reserved for future use and should be no connect. Do not tie the RSVD pins together.
--

AC97/HDA Signals Descriptions						
Signal	Pin#	Pin Type	Pwr Rail /Tolerance	SH960 PU/PD	Module Base Specification R2.1 Description	COM Express Carrier Design Guide R2.0 Description
AC/HDA_RST#	A30	O CMOS	3.3V Suspend/3.3V	series 33 Ω resistor	Reset output to CODEC, active low.	CODEC Reset.
AC/HDA_SYNC	A29	O CMOS	3.3V/3.3V	series 33 Ω resistor	Sample-synchronization signal to the CODEC(s).	Serial Sample Rate Synchronization.
AC/HDA_BITCLK	A32	I/O CMOS	3.3V/3.3V	series 33 Ω resistor	Serial data clock generated by the external CODEC(s).	24 MHz Serial Bit Clock for HDA CODEC.
AC/HDA_SDOUT	A33	O CMOS	3.3V/3.3V	series 33 Ω resistor	Serial TDM data output to the CODEC.	Audio Serial Data Output Stream.
AC/HDA_SDIN0	B30	I/O CMOS	3.3V Suspend/3.3V		Serial TDM data inputs from up to 3 CODECs.	Audio Serial Data Input Stream from CODEC[0:2].
AC/HDA_SDIN1	B29	I/O CMOS	3.3V Suspend/3.3V			
AC/HDA_SDIN2	B28	I/O CMOS	3.3V Suspend/3.3V	NC		

Gigabit Ethernet Signals Descriptions						
Signal	Pin#	Pin Type	Pwr Rail /Tolerance	SH960 PU/PD	Module Base Specification R2.1 Description	COM Express Carrier Design Guide R2.0 Description
GBE0_MDI0+	A13	I/O Analog	3.3V max Suspend		Gigabit Ethernet Controller 0: Media Dependent Interface Differential Pairs 0,1,2,3. The MDI can operate in 1000, 100 and 10 Mbit / sec modes. Some pairs are unused in some modes, per the following: 1000BASE-T 100BASE-TX 10BASE-T MDI[0]+/- B1_DA+/- TX+/- TX+/- MDI[1]+/- B1_DB+/- RX+/- RX+/- MDI[2]+/- B1_DC+/- MDI[3]+/- B1_DD+/-	Media Dependent Interface (MDI) differential pair 0.
GBE0_MDI0-	A12	I/O Analog	3.3V max Suspend			Media Dependent Interface (MDI) differential pair 1.
GBE0_MDI1+	A10	I/O Analog	3.3V max Suspend			Media Dependent Interface (MDI) differential pair 2. Only used for 1000Mbit/sec Gigabit Ethernet mode.
GBE0_MDI1-	A9	I/O Analog	3.3V max Suspend			Media Dependent Interface (MDI) differential pair 3. Only used for 1000Mbit/sec Gigabit Ethernet mode.
GBE0_MDI2+	A7	I/O Analog	3.3V max Suspend			
GBE0_MDI2-	A6	I/O Analog	3.3V max Suspend			
GBE0_MDI3+	A3	I/O Analog	3.3V max Suspend			
GBE0_MDI3-	A2	I/O Analog	3.3V max Suspend			
GBE0_ACT#	B2	OD CMOS	3.3V Suspend/3.3V			Gigabit Ethernet Controller 0 activity indicator, active low.
GBE0_LINK#	A8	OD CMOS	3.3V Suspend/3.3V		Gigabit Ethernet Controller 0 link indicator, active low.	Ethernet controller 0 link indicator, active low.
GBE0_LINK100#	A4	OD CMOS	3.3V Suspend/3.3V		Gigabit Ethernet Controller 0 100 Mbit / sec link indicator, active low.	Ethernet controller 0 100Mbit/sec link indicator, active low.
GBE0_LINK1000#	A5	OD CMOS	3.3V Suspend/3.3V		Gigabit Ethernet Controller 0 1000 Mbit / sec link indicator, active low.	Ethernet controller 0 1000Mbit/sec link indicator, active low.
GBE0_CTREF	A14	REF	GND min 3.3V max	NC	Reference voltage for Carrier Board Ethernet channel 0 magnetics center tap. The reference voltage is determined by the requirements of the Module PHY and may be as low as 0V and as high as 3.3V. The reference voltage output shall be current limited on the Module. In the case in which the reference is shorted to ground, the current shall be limited to 250 mA or less.	Reference voltage for Carrier Board Ethernet channel 0 magnetics center tap.

SATA Signals Descriptions						
Signal	Pin#	Pin Type	Pwr Rail /Tolerance	SH960 PU/PD	Module Base Specification R2.1 Description	COM Express Carrier Design Guide R2.0 Description
SATA0_TX+	A16	O SATA	AC coupled on Module	AC Coupling capacitor	Serial ATA or SAS Channel 0 transmit differential pair.	Serial ATA channel 0 Transmit output differential pair.
SATA0_TX-	A17	O SATA	AC coupled on Module	AC Coupling capacitor		
SATA0_RX+	A19	I SATA	AC coupled on Module	AC Coupling capacitor	Serial ATA or SAS Channel 0 receive differential pair.	Serial ATA channel 0 Receive input differential pair.
SATA0_RX-	A20	I SATA	AC coupled on Module	AC Coupling capacitor		
SATA1_TX+	B16	O SATA	AC coupled on Module	AC Coupling capacitor	Serial ATA or SAS Channel 1 transmit differential pair.	Serial ATA channel 1 Transmit output differential pair.
SATA1_TX-	B17	O SATA	AC coupled on Module	AC Coupling capacitor		
SATA1_RX+	B19	I SATA	AC coupled on Module	AC Coupling capacitor	Serial ATA or SAS Channel 1 receive differential pair.	Serial ATA channel 1 Receive input differential pair.
SATA1_RX-	B20	I SATA	AC coupled on Module	AC Coupling capacitor		
SATA2_TX+	A22	O SATA	AC coupled on Module	AC Coupling capacitor	Serial ATA or SAS Channel 2 transmit differential pair.	Serial ATA channel 2 Transmit output differential pair.
SATA2_TX-	A23	O SATA	AC coupled on Module	AC Coupling capacitor		
SATA2_RX+	A25	I SATA	AC coupled on Module	AC Coupling capacitor	Serial ATA or SAS Channel 2 receive differential pair.	Serial ATA channel 2 Receive input differential pair.
SATA2_RX-	A26	I SATA	AC coupled on Module	AC Coupling capacitor		
SATA3_TX+	B22	O SATA	AC coupled on Module	AC Coupling capacitor	Serial ATA or SAS Channel 3 transmit differential pair.	Serial ATA channel 3 Transmit output differential pair.
SATA3_TX-	B23	O SATA	AC coupled on Module	AC Coupling capacitor		
SATA3_RX+	B25	I SATA	AC coupled on Module	AC Coupling capacitor	Serial ATA or SAS Channel 3 receive differential pair.	Serial ATA channel 3 Receive input differential pair.
SATA3_RX-	B26	I SATA	AC coupled on Module	AC Coupling capacitor		
(S)ATA_ACT#	A28	I/O CMOS	3.3V / 3.3V	PU 10K Ω to 3.3V	ATA (parallel and serial) or SAS activity indicator, active low.	Serial ATA activity LED. Open collector output pin driven during SATA command activity.

PCI Express Lanes Signals Descriptions																																																																																																																																														
Signal	Pin#	Pin Type	Pwr Rail /Tolerance	SH960 PU/PD	Module Base Specification R2.1 Description	COM Express Carrier Design Guide R2.0 Description																																																																																																																																								
PCIE_TX0+	A68	O PCIE	AC coupled on Module	AC Coupling capacitor	PCI Express Differential Transmit Pairs 0	PCIE channel 0. Transmit Output differential pair.																																																																																																																																								
PCIE_TX0-	A69			AC Coupling capacitor			PCIE_RX0+	B68	I PCIE	AC coupled off Module		PCI Express Differential Receive Pairs 0	PCIE channel 0. Receive Input differential pair.	PCIE_RX0-	B69		PCIE_TX1+	A64	O PCIE	AC coupled on Module	AC Coupling capacitor	PCI Express Differential Transmit Pairs 1	PCIE channel 1. Transmit Output differential pair.	PCIE_TX1-	A65	AC Coupling capacitor	PCIE_RX1+	B64	I PCIE	AC coupled off Module		PCI Express Differential Receive Pairs 1	PCIE channel 1. Receive Input differential pair.	PCIE_RX1-	B65		PCIE_TX2+	A61	O PCIE	AC coupled on Module	AC Coupling capacitor	PCI Express Differential Transmit Pairs 2	PCIE channel 2. Transmit Output differential pair.	PCIE_TX2-	A62	AC Coupling capacitor	PCIE_RX2+	B61	I PCIE	AC coupled off Module		PCI Express Differential Receive Pairs 2	PCIE channel 2. Receive Input differential pair.	PCIE_RX2-	B62		PCIE_TX3+	A58	O PCIE	AC coupled on Module	AC Coupling capacitor	PCI Express Differential Transmit Pairs 3	PCIE channel 3. Transmit Output differential pair.	PCIE_TX3-	A59	AC Coupling capacitor	PCIE_RX3+	B58	I PCIE	AC coupled off Module		PCI Express Differential Receive Pairs 3	PCIE channel 3. Receive Input differential pair.	PCIE_RX3-	B59		PCIE_TX4+	A55	O PCIE	AC coupled on Module	AC Coupling capacitor	PCI Express Differential Transmit Pairs 4	PCIE channel 4. Transmit Output differential pair.	PCIE_TX4-	A56	AC Coupling capacitor	PCIE_RX4+	B55	I PCIE	AC coupled off Module		PCI Express Differential Receive Pairs 4	PCIE channel 4. Receive Input differential pair.	PCIE_RX4-	B56		PCIE_TX5+	A52	O PCIE	AC coupled on Module	AC Coupling capacitor	PCI Express Differential Transmit Pairs 5	PCIE channel 5. Transmit Output differential pair.	PCIE_TX5-	A53	AC Coupling capacitor	PCIE_RX5+	B52	I PCIE	AC coupled off Module		PCI Express Differential Receive Pairs 5	PCIE channel 5. Receive Input differential pair.	PCIE_RX5-	B53		PCIE_TX6+	D19	O PCIE	AC coupled on Module	AC Coupling capacitor	PCI Express Differential Transmit Pairs 6	PCIE channel 6. Transmit Output differential pair.	PCIE_TX6-	D20	AC Coupling capacitor	PCIE_RX6+	C19	I PCIE	AC coupled off Module		PCI Express Differential Receive Pairs 6	PCIE channel 6. Receive Input differential pair.	PCIE_RX6-	C20		PCIE_TX7+	D22	O PCIE	AC coupled on Module	AC Coupling capacitor	PCI Express Differential Transmit Pairs 7
PCIE_RX0+	B68	I PCIE	AC coupled off Module		PCI Express Differential Receive Pairs 0	PCIE channel 0. Receive Input differential pair.																																																																																																																																								
PCIE_RX0-	B69						PCIE_TX1+	A64	O PCIE	AC coupled on Module	AC Coupling capacitor	PCI Express Differential Transmit Pairs 1	PCIE channel 1. Transmit Output differential pair.	PCIE_TX1-	A65	AC Coupling capacitor	PCIE_RX1+	B64	I PCIE	AC coupled off Module		PCI Express Differential Receive Pairs 1	PCIE channel 1. Receive Input differential pair.	PCIE_RX1-	B65		PCIE_TX2+	A61	O PCIE	AC coupled on Module	AC Coupling capacitor	PCI Express Differential Transmit Pairs 2	PCIE channel 2. Transmit Output differential pair.	PCIE_TX2-	A62	AC Coupling capacitor	PCIE_RX2+	B61	I PCIE	AC coupled off Module		PCI Express Differential Receive Pairs 2	PCIE channel 2. Receive Input differential pair.	PCIE_RX2-	B62		PCIE_TX3+	A58	O PCIE	AC coupled on Module	AC Coupling capacitor	PCI Express Differential Transmit Pairs 3	PCIE channel 3. Transmit Output differential pair.	PCIE_TX3-	A59	AC Coupling capacitor	PCIE_RX3+	B58	I PCIE	AC coupled off Module		PCI Express Differential Receive Pairs 3	PCIE channel 3. Receive Input differential pair.	PCIE_RX3-	B59		PCIE_TX4+	A55	O PCIE	AC coupled on Module	AC Coupling capacitor	PCI Express Differential Transmit Pairs 4	PCIE channel 4. Transmit Output differential pair.	PCIE_TX4-	A56	AC Coupling capacitor	PCIE_RX4+	B55	I PCIE	AC coupled off Module		PCI Express Differential Receive Pairs 4	PCIE channel 4. Receive Input differential pair.	PCIE_RX4-	B56		PCIE_TX5+	A52	O PCIE	AC coupled on Module	AC Coupling capacitor	PCI Express Differential Transmit Pairs 5	PCIE channel 5. Transmit Output differential pair.	PCIE_TX5-	A53	AC Coupling capacitor	PCIE_RX5+	B52	I PCIE	AC coupled off Module		PCI Express Differential Receive Pairs 5	PCIE channel 5. Receive Input differential pair.	PCIE_RX5-	B53		PCIE_TX6+	D19	O PCIE	AC coupled on Module	AC Coupling capacitor	PCI Express Differential Transmit Pairs 6	PCIE channel 6. Transmit Output differential pair.	PCIE_TX6-	D20	AC Coupling capacitor	PCIE_RX6+	C19	I PCIE	AC coupled off Module		PCI Express Differential Receive Pairs 6	PCIE channel 6. Receive Input differential pair.	PCIE_RX6-	C20		PCIE_TX7+	D22	O PCIE	AC coupled on Module	AC Coupling capacitor	PCI Express Differential Transmit Pairs 7	PCIE channel 7. Transmit Output differential pair.	PCIE_TX7-	D23	AC Coupling capacitor						
PCIE_TX1+	A64	O PCIE	AC coupled on Module	AC Coupling capacitor	PCI Express Differential Transmit Pairs 1	PCIE channel 1. Transmit Output differential pair.																																																																																																																																								
PCIE_TX1-	A65			AC Coupling capacitor			PCIE_RX1+	B64	I PCIE	AC coupled off Module		PCI Express Differential Receive Pairs 1	PCIE channel 1. Receive Input differential pair.	PCIE_RX1-	B65		PCIE_TX2+	A61	O PCIE	AC coupled on Module	AC Coupling capacitor	PCI Express Differential Transmit Pairs 2	PCIE channel 2. Transmit Output differential pair.	PCIE_TX2-	A62	AC Coupling capacitor	PCIE_RX2+	B61	I PCIE	AC coupled off Module		PCI Express Differential Receive Pairs 2	PCIE channel 2. Receive Input differential pair.	PCIE_RX2-	B62		PCIE_TX3+	A58	O PCIE	AC coupled on Module	AC Coupling capacitor	PCI Express Differential Transmit Pairs 3	PCIE channel 3. Transmit Output differential pair.	PCIE_TX3-	A59	AC Coupling capacitor	PCIE_RX3+	B58	I PCIE	AC coupled off Module		PCI Express Differential Receive Pairs 3	PCIE channel 3. Receive Input differential pair.	PCIE_RX3-	B59		PCIE_TX4+	A55	O PCIE	AC coupled on Module	AC Coupling capacitor	PCI Express Differential Transmit Pairs 4	PCIE channel 4. Transmit Output differential pair.	PCIE_TX4-	A56	AC Coupling capacitor	PCIE_RX4+	B55	I PCIE	AC coupled off Module		PCI Express Differential Receive Pairs 4	PCIE channel 4. Receive Input differential pair.	PCIE_RX4-	B56		PCIE_TX5+	A52	O PCIE	AC coupled on Module	AC Coupling capacitor	PCI Express Differential Transmit Pairs 5	PCIE channel 5. Transmit Output differential pair.	PCIE_TX5-	A53	AC Coupling capacitor	PCIE_RX5+	B52	I PCIE	AC coupled off Module		PCI Express Differential Receive Pairs 5	PCIE channel 5. Receive Input differential pair.	PCIE_RX5-	B53		PCIE_TX6+	D19	O PCIE	AC coupled on Module	AC Coupling capacitor	PCI Express Differential Transmit Pairs 6	PCIE channel 6. Transmit Output differential pair.	PCIE_TX6-	D20	AC Coupling capacitor	PCIE_RX6+	C19	I PCIE	AC coupled off Module		PCI Express Differential Receive Pairs 6	PCIE channel 6. Receive Input differential pair.	PCIE_RX6-	C20		PCIE_TX7+	D22	O PCIE	AC coupled on Module	AC Coupling capacitor	PCI Express Differential Transmit Pairs 7	PCIE channel 7. Transmit Output differential pair.	PCIE_TX7-	D23	AC Coupling capacitor																
PCIE_RX1+	B64	I PCIE	AC coupled off Module		PCI Express Differential Receive Pairs 1	PCIE channel 1. Receive Input differential pair.																																																																																																																																								
PCIE_RX1-	B65						PCIE_TX2+	A61	O PCIE	AC coupled on Module	AC Coupling capacitor	PCI Express Differential Transmit Pairs 2	PCIE channel 2. Transmit Output differential pair.	PCIE_TX2-	A62	AC Coupling capacitor	PCIE_RX2+	B61	I PCIE	AC coupled off Module		PCI Express Differential Receive Pairs 2	PCIE channel 2. Receive Input differential pair.	PCIE_RX2-	B62		PCIE_TX3+	A58	O PCIE	AC coupled on Module	AC Coupling capacitor	PCI Express Differential Transmit Pairs 3	PCIE channel 3. Transmit Output differential pair.	PCIE_TX3-	A59	AC Coupling capacitor	PCIE_RX3+	B58	I PCIE	AC coupled off Module		PCI Express Differential Receive Pairs 3	PCIE channel 3. Receive Input differential pair.	PCIE_RX3-	B59		PCIE_TX4+	A55	O PCIE	AC coupled on Module	AC Coupling capacitor	PCI Express Differential Transmit Pairs 4	PCIE channel 4. Transmit Output differential pair.	PCIE_TX4-	A56	AC Coupling capacitor	PCIE_RX4+	B55	I PCIE	AC coupled off Module		PCI Express Differential Receive Pairs 4	PCIE channel 4. Receive Input differential pair.	PCIE_RX4-	B56		PCIE_TX5+	A52	O PCIE	AC coupled on Module	AC Coupling capacitor	PCI Express Differential Transmit Pairs 5	PCIE channel 5. Transmit Output differential pair.	PCIE_TX5-	A53	AC Coupling capacitor	PCIE_RX5+	B52	I PCIE	AC coupled off Module		PCI Express Differential Receive Pairs 5	PCIE channel 5. Receive Input differential pair.	PCIE_RX5-	B53		PCIE_TX6+	D19	O PCIE	AC coupled on Module	AC Coupling capacitor	PCI Express Differential Transmit Pairs 6	PCIE channel 6. Transmit Output differential pair.	PCIE_TX6-	D20	AC Coupling capacitor	PCIE_RX6+	C19	I PCIE	AC coupled off Module		PCI Express Differential Receive Pairs 6	PCIE channel 6. Receive Input differential pair.	PCIE_RX6-	C20		PCIE_TX7+	D22	O PCIE	AC coupled on Module	AC Coupling capacitor	PCI Express Differential Transmit Pairs 7	PCIE channel 7. Transmit Output differential pair.	PCIE_TX7-	D23	AC Coupling capacitor																										
PCIE_TX2+	A61	O PCIE	AC coupled on Module	AC Coupling capacitor	PCI Express Differential Transmit Pairs 2	PCIE channel 2. Transmit Output differential pair.																																																																																																																																								
PCIE_TX2-	A62			AC Coupling capacitor			PCIE_RX2+	B61	I PCIE	AC coupled off Module		PCI Express Differential Receive Pairs 2	PCIE channel 2. Receive Input differential pair.	PCIE_RX2-	B62		PCIE_TX3+	A58	O PCIE	AC coupled on Module	AC Coupling capacitor	PCI Express Differential Transmit Pairs 3	PCIE channel 3. Transmit Output differential pair.	PCIE_TX3-	A59	AC Coupling capacitor	PCIE_RX3+	B58	I PCIE	AC coupled off Module		PCI Express Differential Receive Pairs 3	PCIE channel 3. Receive Input differential pair.	PCIE_RX3-	B59		PCIE_TX4+	A55	O PCIE	AC coupled on Module	AC Coupling capacitor	PCI Express Differential Transmit Pairs 4	PCIE channel 4. Transmit Output differential pair.	PCIE_TX4-	A56	AC Coupling capacitor	PCIE_RX4+	B55	I PCIE	AC coupled off Module		PCI Express Differential Receive Pairs 4	PCIE channel 4. Receive Input differential pair.	PCIE_RX4-	B56		PCIE_TX5+	A52	O PCIE	AC coupled on Module	AC Coupling capacitor	PCI Express Differential Transmit Pairs 5	PCIE channel 5. Transmit Output differential pair.	PCIE_TX5-	A53	AC Coupling capacitor	PCIE_RX5+	B52	I PCIE	AC coupled off Module		PCI Express Differential Receive Pairs 5	PCIE channel 5. Receive Input differential pair.	PCIE_RX5-	B53		PCIE_TX6+	D19	O PCIE	AC coupled on Module	AC Coupling capacitor	PCI Express Differential Transmit Pairs 6	PCIE channel 6. Transmit Output differential pair.	PCIE_TX6-	D20	AC Coupling capacitor	PCIE_RX6+	C19	I PCIE	AC coupled off Module		PCI Express Differential Receive Pairs 6	PCIE channel 6. Receive Input differential pair.	PCIE_RX6-	C20		PCIE_TX7+	D22	O PCIE	AC coupled on Module	AC Coupling capacitor	PCI Express Differential Transmit Pairs 7	PCIE channel 7. Transmit Output differential pair.	PCIE_TX7-	D23	AC Coupling capacitor																																				
PCIE_RX2+	B61	I PCIE	AC coupled off Module		PCI Express Differential Receive Pairs 2	PCIE channel 2. Receive Input differential pair.																																																																																																																																								
PCIE_RX2-	B62						PCIE_TX3+	A58	O PCIE	AC coupled on Module	AC Coupling capacitor	PCI Express Differential Transmit Pairs 3	PCIE channel 3. Transmit Output differential pair.	PCIE_TX3-	A59	AC Coupling capacitor	PCIE_RX3+	B58	I PCIE	AC coupled off Module		PCI Express Differential Receive Pairs 3	PCIE channel 3. Receive Input differential pair.	PCIE_RX3-	B59		PCIE_TX4+	A55	O PCIE	AC coupled on Module	AC Coupling capacitor	PCI Express Differential Transmit Pairs 4	PCIE channel 4. Transmit Output differential pair.	PCIE_TX4-	A56	AC Coupling capacitor	PCIE_RX4+	B55	I PCIE	AC coupled off Module		PCI Express Differential Receive Pairs 4	PCIE channel 4. Receive Input differential pair.	PCIE_RX4-	B56		PCIE_TX5+	A52	O PCIE	AC coupled on Module	AC Coupling capacitor	PCI Express Differential Transmit Pairs 5	PCIE channel 5. Transmit Output differential pair.	PCIE_TX5-	A53	AC Coupling capacitor	PCIE_RX5+	B52	I PCIE	AC coupled off Module		PCI Express Differential Receive Pairs 5	PCIE channel 5. Receive Input differential pair.	PCIE_RX5-	B53		PCIE_TX6+	D19	O PCIE	AC coupled on Module	AC Coupling capacitor	PCI Express Differential Transmit Pairs 6	PCIE channel 6. Transmit Output differential pair.	PCIE_TX6-	D20	AC Coupling capacitor	PCIE_RX6+	C19	I PCIE	AC coupled off Module		PCI Express Differential Receive Pairs 6	PCIE channel 6. Receive Input differential pair.	PCIE_RX6-	C20		PCIE_TX7+	D22	O PCIE	AC coupled on Module	AC Coupling capacitor	PCI Express Differential Transmit Pairs 7	PCIE channel 7. Transmit Output differential pair.	PCIE_TX7-	D23	AC Coupling capacitor																																														
PCIE_TX3+	A58	O PCIE	AC coupled on Module	AC Coupling capacitor	PCI Express Differential Transmit Pairs 3	PCIE channel 3. Transmit Output differential pair.																																																																																																																																								
PCIE_TX3-	A59			AC Coupling capacitor			PCIE_RX3+	B58	I PCIE	AC coupled off Module		PCI Express Differential Receive Pairs 3	PCIE channel 3. Receive Input differential pair.	PCIE_RX3-	B59		PCIE_TX4+	A55	O PCIE	AC coupled on Module	AC Coupling capacitor	PCI Express Differential Transmit Pairs 4	PCIE channel 4. Transmit Output differential pair.	PCIE_TX4-	A56	AC Coupling capacitor	PCIE_RX4+	B55	I PCIE	AC coupled off Module		PCI Express Differential Receive Pairs 4	PCIE channel 4. Receive Input differential pair.	PCIE_RX4-	B56		PCIE_TX5+	A52	O PCIE	AC coupled on Module	AC Coupling capacitor	PCI Express Differential Transmit Pairs 5	PCIE channel 5. Transmit Output differential pair.	PCIE_TX5-	A53	AC Coupling capacitor	PCIE_RX5+	B52	I PCIE	AC coupled off Module		PCI Express Differential Receive Pairs 5	PCIE channel 5. Receive Input differential pair.	PCIE_RX5-	B53		PCIE_TX6+	D19	O PCIE	AC coupled on Module	AC Coupling capacitor	PCI Express Differential Transmit Pairs 6	PCIE channel 6. Transmit Output differential pair.	PCIE_TX6-	D20	AC Coupling capacitor	PCIE_RX6+	C19	I PCIE	AC coupled off Module		PCI Express Differential Receive Pairs 6	PCIE channel 6. Receive Input differential pair.	PCIE_RX6-	C20		PCIE_TX7+	D22	O PCIE	AC coupled on Module	AC Coupling capacitor	PCI Express Differential Transmit Pairs 7	PCIE channel 7. Transmit Output differential pair.	PCIE_TX7-	D23	AC Coupling capacitor																																																								
PCIE_RX3+	B58	I PCIE	AC coupled off Module		PCI Express Differential Receive Pairs 3	PCIE channel 3. Receive Input differential pair.																																																																																																																																								
PCIE_RX3-	B59						PCIE_TX4+	A55	O PCIE	AC coupled on Module	AC Coupling capacitor	PCI Express Differential Transmit Pairs 4	PCIE channel 4. Transmit Output differential pair.	PCIE_TX4-	A56	AC Coupling capacitor	PCIE_RX4+	B55	I PCIE	AC coupled off Module		PCI Express Differential Receive Pairs 4	PCIE channel 4. Receive Input differential pair.	PCIE_RX4-	B56		PCIE_TX5+	A52	O PCIE	AC coupled on Module	AC Coupling capacitor	PCI Express Differential Transmit Pairs 5	PCIE channel 5. Transmit Output differential pair.	PCIE_TX5-	A53	AC Coupling capacitor	PCIE_RX5+	B52	I PCIE	AC coupled off Module		PCI Express Differential Receive Pairs 5	PCIE channel 5. Receive Input differential pair.	PCIE_RX5-	B53		PCIE_TX6+	D19	O PCIE	AC coupled on Module	AC Coupling capacitor	PCI Express Differential Transmit Pairs 6	PCIE channel 6. Transmit Output differential pair.	PCIE_TX6-	D20	AC Coupling capacitor	PCIE_RX6+	C19	I PCIE	AC coupled off Module		PCI Express Differential Receive Pairs 6	PCIE channel 6. Receive Input differential pair.	PCIE_RX6-	C20		PCIE_TX7+	D22	O PCIE	AC coupled on Module	AC Coupling capacitor	PCI Express Differential Transmit Pairs 7	PCIE channel 7. Transmit Output differential pair.	PCIE_TX7-	D23	AC Coupling capacitor																																																																		
PCIE_TX4+	A55	O PCIE	AC coupled on Module	AC Coupling capacitor	PCI Express Differential Transmit Pairs 4	PCIE channel 4. Transmit Output differential pair.																																																																																																																																								
PCIE_TX4-	A56			AC Coupling capacitor			PCIE_RX4+	B55	I PCIE	AC coupled off Module		PCI Express Differential Receive Pairs 4	PCIE channel 4. Receive Input differential pair.	PCIE_RX4-	B56		PCIE_TX5+	A52	O PCIE	AC coupled on Module	AC Coupling capacitor	PCI Express Differential Transmit Pairs 5	PCIE channel 5. Transmit Output differential pair.	PCIE_TX5-	A53	AC Coupling capacitor	PCIE_RX5+	B52	I PCIE	AC coupled off Module		PCI Express Differential Receive Pairs 5	PCIE channel 5. Receive Input differential pair.	PCIE_RX5-	B53		PCIE_TX6+	D19	O PCIE	AC coupled on Module	AC Coupling capacitor	PCI Express Differential Transmit Pairs 6	PCIE channel 6. Transmit Output differential pair.	PCIE_TX6-	D20	AC Coupling capacitor	PCIE_RX6+	C19	I PCIE	AC coupled off Module		PCI Express Differential Receive Pairs 6	PCIE channel 6. Receive Input differential pair.	PCIE_RX6-	C20		PCIE_TX7+	D22	O PCIE	AC coupled on Module	AC Coupling capacitor	PCI Express Differential Transmit Pairs 7	PCIE channel 7. Transmit Output differential pair.	PCIE_TX7-	D23	AC Coupling capacitor																																																																												
PCIE_RX4+	B55	I PCIE	AC coupled off Module		PCI Express Differential Receive Pairs 4	PCIE channel 4. Receive Input differential pair.																																																																																																																																								
PCIE_RX4-	B56						PCIE_TX5+	A52	O PCIE	AC coupled on Module	AC Coupling capacitor	PCI Express Differential Transmit Pairs 5	PCIE channel 5. Transmit Output differential pair.	PCIE_TX5-	A53	AC Coupling capacitor	PCIE_RX5+	B52	I PCIE	AC coupled off Module		PCI Express Differential Receive Pairs 5	PCIE channel 5. Receive Input differential pair.	PCIE_RX5-	B53		PCIE_TX6+	D19	O PCIE	AC coupled on Module	AC Coupling capacitor	PCI Express Differential Transmit Pairs 6	PCIE channel 6. Transmit Output differential pair.	PCIE_TX6-	D20	AC Coupling capacitor	PCIE_RX6+	C19	I PCIE	AC coupled off Module		PCI Express Differential Receive Pairs 6	PCIE channel 6. Receive Input differential pair.	PCIE_RX6-	C20		PCIE_TX7+	D22	O PCIE	AC coupled on Module	AC Coupling capacitor	PCI Express Differential Transmit Pairs 7	PCIE channel 7. Transmit Output differential pair.	PCIE_TX7-	D23	AC Coupling capacitor																																																																																						
PCIE_TX5+	A52	O PCIE	AC coupled on Module	AC Coupling capacitor	PCI Express Differential Transmit Pairs 5	PCIE channel 5. Transmit Output differential pair.																																																																																																																																								
PCIE_TX5-	A53			AC Coupling capacitor			PCIE_RX5+	B52	I PCIE	AC coupled off Module		PCI Express Differential Receive Pairs 5	PCIE channel 5. Receive Input differential pair.	PCIE_RX5-	B53		PCIE_TX6+	D19	O PCIE	AC coupled on Module	AC Coupling capacitor	PCI Express Differential Transmit Pairs 6	PCIE channel 6. Transmit Output differential pair.	PCIE_TX6-	D20	AC Coupling capacitor	PCIE_RX6+	C19	I PCIE	AC coupled off Module		PCI Express Differential Receive Pairs 6	PCIE channel 6. Receive Input differential pair.	PCIE_RX6-	C20		PCIE_TX7+	D22	O PCIE	AC coupled on Module	AC Coupling capacitor	PCI Express Differential Transmit Pairs 7	PCIE channel 7. Transmit Output differential pair.	PCIE_TX7-	D23	AC Coupling capacitor																																																																																																
PCIE_RX5+	B52	I PCIE	AC coupled off Module		PCI Express Differential Receive Pairs 5	PCIE channel 5. Receive Input differential pair.																																																																																																																																								
PCIE_RX5-	B53						PCIE_TX6+	D19	O PCIE	AC coupled on Module	AC Coupling capacitor	PCI Express Differential Transmit Pairs 6	PCIE channel 6. Transmit Output differential pair.	PCIE_TX6-	D20	AC Coupling capacitor	PCIE_RX6+	C19	I PCIE	AC coupled off Module		PCI Express Differential Receive Pairs 6	PCIE channel 6. Receive Input differential pair.	PCIE_RX6-	C20		PCIE_TX7+	D22	O PCIE	AC coupled on Module	AC Coupling capacitor	PCI Express Differential Transmit Pairs 7	PCIE channel 7. Transmit Output differential pair.	PCIE_TX7-	D23	AC Coupling capacitor																																																																																																										
PCIE_TX6+	D19	O PCIE	AC coupled on Module	AC Coupling capacitor	PCI Express Differential Transmit Pairs 6	PCIE channel 6. Transmit Output differential pair.																																																																																																																																								
PCIE_TX6-	D20			AC Coupling capacitor			PCIE_RX6+	C19	I PCIE	AC coupled off Module		PCI Express Differential Receive Pairs 6	PCIE channel 6. Receive Input differential pair.	PCIE_RX6-	C20		PCIE_TX7+	D22	O PCIE	AC coupled on Module	AC Coupling capacitor	PCI Express Differential Transmit Pairs 7	PCIE channel 7. Transmit Output differential pair.	PCIE_TX7-	D23	AC Coupling capacitor																																																																																																																				
PCIE_RX6+	C19	I PCIE	AC coupled off Module		PCI Express Differential Receive Pairs 6	PCIE channel 6. Receive Input differential pair.																																																																																																																																								
PCIE_RX6-	C20						PCIE_TX7+	D22	O PCIE	AC coupled on Module	AC Coupling capacitor	PCI Express Differential Transmit Pairs 7	PCIE channel 7. Transmit Output differential pair.	PCIE_TX7-	D23	AC Coupling capacitor																																																																																																																														
PCIE_TX7+	D22	O PCIE	AC coupled on Module	AC Coupling capacitor	PCI Express Differential Transmit Pairs 7	PCIE channel 7. Transmit Output differential pair.																																																																																																																																								
PCIE_TX7-	D23			AC Coupling capacitor																																																																																																																																										

PCI Express Lanes Signals Descriptions						
Signal	Pin#	Pin Type	Pwr Rail /Tolerance	SH960 PU/PD	Module Base Specification R2.1 Description	COM Express Carrier Design Guide R2.0 Description
PCIE_RX7+	C22	I PCIE	AC coupled off Module		PCI Express Differential Receive Pairs 7	PCIe channel 7. Receive Input differential pair.
PCIE_RX7-	C23					
PCIE_CLK_REF+	A88	O PCIE	PCIE		Reference clock output for all PCI Express and PCI Express Graphics lanes.	PCIe Reference Clock for all COM Express PCIe lanes, and for PEG lanes.
PCIE_CLK_REF-	A89					

PEG Signals Descriptions						
Signal	Pin#	Pin Type	Pwr Rail /Tolerance	SH960 PU/PD	Module Base Specification R2.1 Description	COM Express Carrier Design Guide R2.0 Description
PEG_TX0+	D52	O PCIE	AC coupled on Module	AC Coupling capacitor	PCI Express Graphics transmit differential pairs 0	PEG channel 0, Transmit Output differential pair.
PEG_TX0-	D53			AC Coupling capacitor		
PEG_RX0+	C52	I PCIE	AC coupled off Module		PCI Express Graphics receive differential pairs 0	PEG channel 0, Receive Input differential pair.
PEG_RX0-	C53					
PEG_TX1+	D55	O PCIE	AC coupled on Module	AC Coupling capacitor	PCI Express Graphics transmit differential pairs 1	PEG channel 1, Transmit Output differential pair.
PEG_TX1-	D56			AC Coupling capacitor		
PEG_RX1+	C55	I PCIE	AC coupled off Module		PCI Express Graphics receive differential pairs 1	PEG channel 1, Receive Input differential pair.
PEG_RX1-	C56					
PEG_TX2+	D58	O PCIE	AC coupled on Module	AC Coupling capacitor	PCI Express Graphics transmit differential pairs 2	PEG channel 2, Transmit Output differential pair.
PEG_TX2-	D59			AC Coupling capacitor		
PEG_RX2+	C58	I PCIE	AC coupled off Module		PCI Express Graphics receive differential pairs 2	PEG channel 2, Receive Input differential pair.
PEG_RX2-	C59					
PEG_TX3+	D61	O PCIE	AC coupled on Module	AC Coupling capacitor	PCI Express Graphics transmit differential pairs 3	PEG channel 3, Transmit Output differential pair.
PEG_TX3-	D62			AC Coupling capacitor		
PEG_RX3+	C61	I PCIE	AC coupled off Module		PCI Express Graphics receive differential pairs 3	PEG channel 3, Receive Input differential pair.
PEG_RX3-	C62					
PEG_TX4+	D65	O PCIE	AC coupled on Module	AC Coupling capacitor	PCI Express Graphics transmit differential pairs 4	PEG channel 4, Transmit Output differential pair.
PEG_TX4-	D66			AC Coupling capacitor		
PEG_RX4+	C65	I PCIE	AC coupled off Module		PCI Express Graphics receive differential pairs 4	PEG channel 4, Receive Input differential pair.
PEG_RX4-	C66					
PEG_TX5+	D68	O PCIE	AC coupled on Module	AC Coupling capacitor	PCI Express Graphics transmit differential pairs 5	PEG channel 5, Transmit Output differential pair.
PEG_TX5-	D69			AC Coupling capacitor		
PEG_RX5+	C68	I PCIE	AC coupled off Module		PCI Express Graphics receive differential pairs 5	PEG channel 5, Receive Input differential pair.
PEG_RX5-	C69					

PEG Signals Descriptions						
Signal	Pin#	Pin Type	Pwr Rail /Tolerance	SH960 PU/PD	Module Base Specification R2.1 Description	COM Express Carrier Design Guide R2.0 Description
PEG_TX6+	D71	O PCIE	AC coupled on Module	AC Coupling capacitor	PCI Express Graphics transmit differential pairs 6	PEG channel 6, Transmit Output differential pair.
PEG_TX6-	D72			AC Coupling capacitor		
PEG_RX6+	C71	I PCIE	AC coupled off Module		PCI Express Graphics receive differential pairs 6	PEG channel 6, Receive Input differential pair.
PEG_RX6-	C72					
PEG_TX7+	D74	O PCIE	AC coupled on Module	AC Coupling capacitor	PCI Express Graphics transmit differential pairs 7	PEG channel 7, Transmit Output differential pair.
PEG_TX7-	D75			AC Coupling capacitor		
PEG_RX7+	C74	I PCIE	AC coupled off Module		PCI Express Graphics receive differential pairs 7	PEG channel 7, Receive Input differential pair.
PEG_RX7-	C75					
PEG_TX8+	D78	O PCIE	AC coupled on Module	AC Coupling capacitor	PCI Express Graphics transmit differential pairs 8	PEG channel 8, Transmit Output differential pair.
PEG_TX8-	D79			AC Coupling capacitor		
PEG_RX8+	C78	I PCIE	AC coupled off Module		PCI Express Graphics receive differential pairs 8	PEG channel 8, Receive Input differential pair.
PEG_RX8-	C79					
PEG_TX9+	D81	O PCIE	AC coupled on Module	AC Coupling capacitor	PCI Express Graphics transmit differential pairs 9	PEG channel 9, Transmit Output differential pair.
PEG_TX9-	D82			AC Coupling capacitor		
PEG_RX9+	C81	I PCIE	AC coupled off Module		PCI Express Graphics receive differential pairs 9	PEG channel 9, Receive Input differential pair.
PEG_RX9-	C82					
PEG_TX10+	D85	O PCIE	AC coupled on Module	AC Coupling capacitor	PCI Express Graphics transmit differential pairs 10	PEG channel 10, Transmit Output differential pair.
PEG_TX10-	D86			AC Coupling capacitor		
PEG_RX10+	C85	I PCIE	AC coupled off Module		PCI Express Graphics receive differential pairs 10	PEG channel 10, Receive Input differential pair.
PEG_RX10-	C86					
PEG_TX11+	D88	O PCIE	AC coupled on Module	AC Coupling capacitor	PCI Express Graphics transmit differential pairs 11	PEG channel 11, Transmit Output differential pair.
PEG_TX11-	D89			AC Coupling capacitor		
PEG_RX11+	C88	I PCIE	AC coupled off Module		PCI Express Graphics receive differential pairs 11	PEG channel 11, Receive Input differential pair.
PEG_RX11-	C89					
PEG_TX12+	D91	O PCIE	AC coupled on Module	AC Coupling capacitor	PCI Express Graphics transmit differential pairs 12	PEG channel 12, Transmit Output differential pair.
PEG_TX12-	D92			AC Coupling capacitor		
PEG_RX12+	C91	I PCIE	AC coupled off Module		PCI Express Graphics receive differential pairs 12	PEG channel 12, Receive Input differential pair.
PEG_RX12-	C92					

PEG Signals Descriptions						
Signal	Pin#	Pin Type	Pwr Rail /Tolerance	SH960 PU/PD	Module Base Specification R2.1 Description	COM Express Carrier Design Guide R2.0 Description
PEG_TX13+	D94	O PCIE	AC coupled on Module	AC Coupling capacitor	PCI Express Graphics transmit differential pairs 13	PEG channel 13 Transmit Output differential pair.
PEG_TX13-	D95			AC Coupling capacitor		
PEG_RX13+	C94	I PCIE	AC coupled off Module		PCI Express Graphics receive differential pairs 13	PEG channel 13, Receive Input differential pair.
PEG_RX13-	C95					
PEG_TX14+	D98	O PCIE	AC coupled on Module	AC Coupling capacitor	PCI Express Graphics transmit differential pairs 14	PEG channel 14, Transmit Output differential pair.
PEG_TX14-	D99			AC Coupling capacitor		
PEG_RX14+	C98	I PCIE	AC coupled off Module		PCI Express Graphics receive differential pairs 14	PEG channel 14, Receive Input differential pair.
PEG_RX14-	C99					
PEG_TX15+	D101	O PCIE	AC coupled on Module	AC Coupling capacitor	PCI Express Graphics transmit differential pairs 15	PEG channel 15, Transmit Output differential pair.
PEG_TX15-	D102			AC Coupling capacitor		
PEG_RX15+	C101	I PCIE	AC coupled off Module		PCI Express Graphics receive differential pairs 15	PEG channel 15, Receive Input differential pair.
PEG_RX15-	C102					
PEG_LANE_RV#	D54	I CMOS	3.3V / 3.3V	PU 10K Ω to 3V3	PCI Express Graphics lane reversal input strap. Pull low on the Carrier board to reverse lane order.	PCI Express Graphics lane reversal input strap. Pull low on the carrier board to reverse lane order.

ExpressCard Signals Descriptions						
Signal	Pin#	Pin Type	Pwr Rail /Tolerance	SH960 PU/PD	Module Base Specification R2.1 Description	COM Express Carrier Design Guide R2.0 Description
EXCD0_CPPE#	A49	I CMOS	3.3V /3.3V	PU 10k to 3.3V	PCI ExpressCard: PCI Express capable card request, active low, one per card	PCI ExpressCard0: PCI Express capable card request, active low, one per card
EXCD0_PERST#	A48	O CMOS	3.3V /3.3V		PCI ExpressCard: reset, active low, one per card	PCI ExpressCard0: reset, active low, one per card
EXCD1_CPPE#	B48	I CMOS	3.3V /3.3V	PU 10k to 3.3V	PCI ExpressCard: PCI Express capable card request, active low, one per card	PCI ExpressCard1: PCI Express capable card request, active low, one per card
EXCD1_PERST#	B47	O CMOS	3.3V /3.3V		PCI ExpressCard: reset, active low, one per card	PCI ExpressCard1: reset, active low, one per card

USB Signals Descriptions						
Signal	Pin#	Pin Type	Pwr Rail /Tolerance	SH960 PU/PD	Module Base Specification R2.1 Description	COM Express Carrier Design Guide R2.0 Description
USB0+	A46	I/O USB	3.3V Suspend/3.3V		USB differential pairs, channel 0	USB Port 0, data + or D+
USB0-	A45					USB Port 0, data - or D-
USB1+	B46	I/O USB	3.3V Suspend/3.3V		USB differential pairs, channel 1	USB Port 1, data + or D+
USB1-	B45					USB Port 1, data - or D-
USB2+	A43	I/O USB	3.3V Suspend/3.3V		USB differential pairs, channel 2	USB Port 2, data + or D+
USB2-	A42					USB Port 2, data - or D-
USB3+	B43	I/O USB	3.3V Suspend/3.3V		USB differential pairs, channel 3	USB Port 3, data + or D+
USB3-	B42					USB Port 3, data - or D-

USB Signals Descriptions						
Signal	Pin#	Pin Type	Pwr Rail /Tolerance	SH960 PU/PD	Module Base Specification R2.1 Description	COM Express Carrier Design Guide R2.0 Description
USB4+	A40	I/O USB	3.3V Suspend/3.3V		USB differential pairs, channel 4	USB Port 4, data + or D+
USB4-	A39					USB Port 4, data - or D-
USB5+	B40	I/O USB	3.3V Suspend/3.3V		USB differential pairs, channel 5	USB Port 5, data + or D+
USB5-	B39					USB Port 5, data - or D-
USB6+	A37	I/O USB	3.3V Suspend/3.3V		USB differential pairs, channel 6	USB Port 6, data + or D+
USB6-	A36					USB Port 6, data - or D-
USB7+	B37	I/O USB	3.3V Suspend/3.3V		USB differential pairs, channel 7. USB7 may be configured as a USB client or as a host, or both, at the Module designer's discretion. (SH960 default set as a host)	USB Port 7, data + or D+
USB7-	B36					USB Port 7, data - or D-
USB_0_1_OC#	B44	I CMOS	3.3V Suspend/3.3V	PU 10K Ω to 3.3V Suspend	USB over-current sense, USB channels 0 and 1. A pull-up for this line shall be present on the Module. An open drain driver from a USB current monitor on the Carrier Board may drive this line low. Do not pull this line high on the Carrier Board.	USB over-current sense, USB ports 0 and 1.
USB_2_3_OC#	A44	I CMOS	3.3V Suspend/3.3V	PU 10K Ω to 3.3V Suspend	USB over-current sense, USB channels 2 and 3. A pull-up for this line shall be present on the Module. An open drain driver from a USB current monitor on the Carrier Board may drive this line low. Do not pull this line high on the Carrier Board.	USB over-current sense, USB ports 2 and 3.
USB_4_5_OC#	B38	I CMOS	3.3V Suspend/3.3V	PU 10K Ω to 3.3V Suspend	USB over-current sense, USB channels 4 and 5. A pull-up for this line shall be present on the Module. An open drain driver from a USB current monitor on the Carrier Board may drive this line low. Do not pull this line high on the Carrier Board.	USB over-current sense, USB ports 4 and 5.
USB_6_7_OC#	A38	I CMOS	3.3V Suspend/3.3V	PU 10K Ω to 3.3V Suspend	USB over-current sense, USB channels 6 and 7. A pull-up for this line shall be present on the Module. An open drain driver from a USB current monitor on the Carrier Board may drive this line low. Do not pull this line high on the Carrier Board.	USB over-current sense, USB ports 6 and 7.
USB_SSTX0+	D4	O PCIE	AC coupled on Module	AC Coupling capacitor	Additional transmit signal differential pairs for the SuperSpeed USB data path.	USB Port 0, SuperSpeed TX +
USB_SSTX0-	D3			AC Coupling capacitor		USB Port 0, SuperSpeed TX -
USB_SSRX0+	C4	I PCIE	AC coupled off Module		Additional receive signal differential pairs for the SuperSpeed USB data path.	USB Port 0, SuperSpeed RX +
USB_SSRX0-	C3					USB Port 0, SuperSpeed RX -
USB_SSTX1+	D7	O PCIE	AC coupled on Module	AC Coupling capacitor	Additional transmit signal differential pairs for the SuperSpeed USB data path.	USB Port 1, SuperSpeed TX +
USB_SSTX1-	D6			AC Coupling capacitor		USB Port 1, SuperSpeed TX -
USB_SSRX1+	C7	I PCIE	AC coupled off Module		Additional receive signal differential pairs for the SuperSpeed USB data path.	USB Port 1, SuperSpeed RX +
USB_SSRX1-	C6					USB Port 1, SuperSpeed RX -
USB_SSTX2+	D10	O PCIE	AC coupled on Module	AC Coupling capacitor	Additional transmit signal differential pairs for the SuperSpeed USB data path.	USB Port 2, SuperSpeed TX +
USB_SSTX2-	D9			AC Coupling capacitor		USB Port 2, SuperSpeed TX -
USB_SSRX2+	C10	I PCIE	AC coupled off Module		Additional receive signal differential pairs for the SuperSpeed USB data path.	USB Port 2, SuperSpeed RX +
USB_SSRX2-	C9					USB Port 2, SuperSpeed RX -
USB_SSTX3+	D13	O PCIE	AC coupled on Module	AC Coupling capacitor	Additional transmit signal differential pairs for the SuperSpeed USB data path.	USB Port 3, SuperSpeed TX +
USB_SSTX3-	D12			AC Coupling capacitor		USB Port 3, SuperSpeed TX -

USB Signals Descriptions						
Signal	Pin#	Pin Type	Pwr Rail /Tolerance	SH960 PU/PD	Module Base Specification R2.1 Description	COM Express Carrier Design Guide R2.0 Description
USB_SSRX3+	C13	I PCIE	AC coupled off Module		Additional receive signal differential pairs for the SuperSpeed USB data path.	USB Port 3, SuperSpeed RX +
USB_SSRX3-	C12					USB Port 3, SuperSpeed RX -

LVDS Signals Descriptions						
Signal	Pin#	Pin Type	Pwr Rail /Tolerance	SH960 PU/PD	Module Base Specification R2.1 Description	COM Express Carrier Design Guide R2.0 Description
LVDS_A0+/eDP_TX2+	A71	O LVDS	LVDS EDP: AC coupled off Module			LVDS channel A differential signal pair 0 eDP lane 2, TX± differential signal pair
LVDS_A0-/eDP_TX2-	A72					
LVDS_A1+/eDP_TX1+	A73	O LVDS	LVDS EDP: AC coupled off Module		LVDS Channel A differential pairs The LVDS flat panel differential pairs (LVDS_A[0:3]+/-, LVDS_B[0:3]+/-, LVDS_A_CK+/-, LVDS_B_CK+/-) shall have 100Ω terminations across the pairs at the destination. These terminations may be on the Carrier Board if the Carrier Board implements a LVDS deserializer on-board.	LVDS channel A differential signal pair 1 eDP lane 1, TX± differential signal pair
LVDS_A1-/eDP_TX1-	A74					
LVDS_A2+/eDP_TX0+	A75	O LVDS	LVDS EDP: AC coupled off Module		eDP: eDP differential pairs	LVDS channel A differential signal pair 2 eDP lane 0, TX ± differential signal pair
LVDS_A2-/eDP_TX0-	A76					
LVDS_A3+	A78	O LVDS	LVDS EDP: AC coupled off Module			LVDS channel A differential signal pair 3
LVDS_A3-	A79					
LVDS_A_CK+/eDP_TX3+	A81	O LVDS	LVDS		LVDS Channel A differential clock	LVDS channel A differential clock pair eDP lane 3, TX± differential pair
LVDS_A_CK-/eDP_TX3-	A82					
LVDS_B0+	B71	O LVDS	LVDS			LVDS channel B differential signal pair 0
LVDS_B0-	B72					
LVDS_B1+	B73	O LVDS	LVDS		LVDS Channel B differential pairs The LVDS flat panel differential pairs (LVDS_A[0:3]+/-, LVDS_B[0:3]+/-, LVDS_A_CK+/-, LVDS_B_CK+/-) shall have 100Ω terminations across the pairs at the destination. These terminations may be on the Carrier Board if the Carrier Board implements a LVDS deserializer on-board.	LVDS channel B differential signal pair 1
LVDS_B1-	B74					
LVDS_B2+	B75	O LVDS	LVDS			LVDS channel B differential signal pair 2
LVDS_B2-	B76					
LVDS_B3+	B77	O LVDS	LVDS			LVDS channel B differential signal pair 3
LVDS_B3-	B78					
LVDS_B_CK+	B81	O LVDS	LVDS		LVDS Channel B differential clock	LVDS channel B differential clock pair
LVDS_B_CK-	B82					
LVDS_VDD_EN/eDP_VDD_EN	A77	O CMOS	3.3V / 3.3V		LVDS panel / eDP power enable	LVDS flat panel power enable. eDP power enable
LVDS_BKLT_EN/eDP_BKLT_EN	B79	O CMOS	3.3V / 3.3V		LVDS panel / eDP backlight enable	LVDS flat panel backlight enable high active signal eDP backlight enable
LVDS_BKLT_CTRL/eDP_BKLT_CTRL	B83	O CMOS	3.3V / 3.3V	PD 100KΩ to GND	LVDS panel / eDP backlight brightness control	LVDS flat panel backlight brightness control eDP backlight brightness control
LVDS_I2C_CK/eDP_AUX+	A83	I/O OD CMOS	3.3V / 3.3V	PU 2.2KΩ to 3.3V	I2C clock output for LVDS display use / eDP AUX+	DDC I2C clock signal used for flat panel detection and control. eDP auxiliary lane +
LVDS_I2C_DAT/eDP_AUX-	A84	I/O OD CMOS	3.3V / 3.3V	PU 2.2KΩ to 3.3V	I2C data line for LVDS display use / eDP AUX-	DDC I2C data signal used for flat panel detection and control. eDP auxiliary lane -

LVDS Signals Descriptions						
Signal	Pin#	Pin Type	Pwr Rail /Tolerance	SH960 PU/PD	Module Base Specification R2.1 Description	COM Express Carrier Design Guide R2.0 Description
RSVD/eDP_HPD	A87	I CMOS	3.3V / 3.3V	RSV PD 100K Ω to GND	eDP_HPD:Detection of Hot Plug / Unplug and notification of the link layer	eDP_HPD: Detection of Hot Plug / Unplug and notification of the link layer

LPC Signals Descriptions						
Signal	Pin#	Pin Type	Pwr Rail /Tolerance	SH960 PU/PD	Module Base Specification R2.1 Description	COM Express Carrier Design Guide R2.0 Description
LPC_AD0	B4	I/O CMOS	3.3V / 3.3V		LPC multiplexed address, command and data bus.	LPC multiplexed command, address and data.
LPC_AD1	B5					
LPC_AD2	B6					
LPC_AD3	B7					
LPC_FRAME#	B3	O CMOS	3.3V / 3.3V		LPC frame indicates the start of an LPC cycle	LPC frame indicates start of a new cycle or termination of a broken cycle.
LPC_DRQ0#	B8	I CMOS	3.3V / 3.3V	PU 10K to 3.3V, not support.	LPC serial DMA request	LPC encoded DMA/Bus master request.
LPC_DRQ1#	B9			PU 10K to 3.3V, not support.		
LPC_SERIRQ	A50	I/O CMOS	3.3V / 3.3V	PU 10K to 3.3V	LPC serial interrupt	LPC serialized IRQ.
LPC_CLK	B10	O CMOS	3.3V / 3.3V	series 22 Ω resistor	LPC clock output - 33MHz nominal	LPC clock output 33MHz.

SPI Signals Descriptions						
Signal	Pin#	Pin Type	Pwr Rail /Tolerance	SH960 PU/PD	Module Base Specification R2.1 Description	COM Express Carrier Design Guide R2.0 Description
SPI_CS#	B97	O CMOS	3.3V Suspend/3.3V		Chip select for Carrier Board SPI - may be sourced from chipset SPI0 or SPI1	Chip select for Carrier Board SPI – may be sourced from chipset SPI0 or SPI1
SPI_MISO	A92	I CMOS	3.3V Suspend/3.3V		Data in to Module from Carrier SPI	Data in to Module from Carrier SPI
SPI_MOSI	A95	O CMOS	3.3V Suspend/3.3V		Data out from Module to Carrier SPI	Data out from Module to Carrier SPI
SPI_CLK	A94	O CMOS	3.3V Suspend/3.3V		Clock from Module to Carrier SPI	Clock from Module to Carrier SPI
SPI_POWER	A91	O	3.3V Suspend/3.3V		Power supply for Carrier Board SPI – sourced from Module – nominally 3.3V. The Module shall provide a minimum of 100mA on SPI_POWER. Carriers shall use less than 100mA of SPI_POWER. SPI_POWER shall only be used to power SPI devices on the Carrier Board.	Power supply for Carrier Board SPI – sourced from Module – nominally 3.3V. The Module shall provide a minimum of 100mA on SPI_POWER. Carriers shall use less than 100mA of SPI_POWER. SPI_POWER shall only be used to power SPI devices on the Carrier.
BIOS_DIS0#	A34	I CMOS	NA	PU 10K Ω to 3V3 Suspend.	Selection straps to determine the BIOS boot device. The Carrier should only float these or pull them low, please refer to COM Express Module Base Specification Revision 2.1 for strapping options of BIOS disable signals.	Selection strap to determine the BIOS boot device. The Carrier should only float these or pull them low, please refer to for strapping options of BIOS disable signals.
BIOS_DIS1#	B88			PU 10K Ω to 3V3 Suspend.		

VGA Signals Descriptions

Signal	Pin#	Pin Type	Pwr Rail /Tolerance	SH960 PU/PD	Module Base Specification R2.1 Description	COM Express Carrier Design Guide R2.0 Description
VGA_RED	B89	O Analog	Analog	PD 150 Ω to GND	Red for monitor. Analog DAC output, designed to drive a 37.5 Ω equivalent load.	Red component of analog DAC monitor output, designed to drive a 37.5 Ω equivalent load.
VGA_GRN	B91	O Analog	Analog	PD 150 Ω to GND	Green for monitor. Analog DAC output, designed to drive a 37.5 Ω equivalent load.	Green component of analog DAC monitor output, designed to drive a 37.5 Ω equivalent load.
VGA_BLU	B92	O Analog	Analog	PD 150 Ω to GND	Blue for monitor. Analog DAC output, designed to drive a 37.5 Ω equivalent load.	Blue component of analog DAC monitor output, designed to drive a 37.5 Ω equivalent load.
VGA_HSYNC	B93	O CMOS	3.3V / 3.3V		Horizontal sync output to VGA monitor	Horizontal sync output to VGA monitor.
VGA_VSYNC	B94	O CMOS	3.3V / 3.3V		Vertical sync output to VGA monitor	Vertical sync output to VGA monitor.
VGA_I2C_CK	B95	I/O OD CMOS	3.3V / 3.3V	PU 2.2K Ω to 3.3V	DDC clock line (I2C port dedicated to identify VGA monitor capabilities)	DDC clock line (I2C port dedicated to identify VGA monitor capabilities).
VGA_I2C_DAT	B96	I/O OD CMOS	3.3V / 3.3V	PU 2.2K Ω to 3.3V	DDC data line.	DDC data line.

DDI Signals Descriptions

Signal	Pin#	Pin Type	Pwr Rail /Tolerance	SH960 PU/PD	Module Base Specification R2.1 Description	COM Express Carrier Design Guide R2.0 Description
DDI1_PAIR0+	D26	O PCIE	AC coupled off Module		DDI for Display Port: DP1_LANE 0 differential pairs	DP1_LANE0+ for DP / TMDS1_DATA2+ for HDMI or DVI
DDI1_PAIR0-	D27				DDI for SDVO: SDVO1_RED \pm differential pair (Serial Digital Video red output)	DP1_LANE0- for DP / TMDS1_DATA2- for HDMI or DVI
DDI1_PAIR1+	D29	O PCIE	AC coupled off Module		DDI for Display Port: DP1_LANE 1 differential pairs	DP1_LANE1+ for DP / TMDS1_DATA1+ for HDMI or DVI
DDI1_PAIR1-	D30				DDI for SDVO: SDVO1_GRN \pm differential pair (Serial Digital Video green output)	DP1_LANE1- for DP / TMDS1_DATA1- for HDMI or DVI
DDI1_PAIR2+	D32	O PCIE	AC coupled off Module		DDI for Display Port: DP1_LANE 2 differential pairs	DP1_LANE2+ for DP / TMDS1_DATA0+ for HDMI or DVI
DDI1_PAIR2-	D33				DDI for SDVO: SDVO1_BLU \pm differential pair (Serial Digital Video blue output)	DP1_LANE2- for DP / TMDS1_DATA0- for HDMI or DVI
DDI1_PAIR3+	D36	O PCIE	AC coupled off Module		DDI for Display Port: DP1_LANE 3 differential pairs	DP1_LANE3+ for DP / TMDS1_CLK+
DDI1_PAIR3-	D37				DDI for SDVO: SDVO1_CK \pm differential pair (Serial Digital Video clock output)	DP1_LANE3- for DP / TMDS1_CLK-
DDI1_PAIR4+	C25	I PCIE	AC coupled off Module	NC	DDI for SDVO: SDVO1_INT \pm differential pair	NA
DDI1_PAIR4-	C26				DDI for SDVO: SDVO1_INT \pm differential pair (Serial Digital Video B interrupt input differential pair)	NA
DDI1_PAIR5+	C29	I PCIE	AC coupled off Module	NC	DDI for SDVO: SDVO1_TVCLKIN \pm differential pair	NA
DDI1_PAIR5-	C30				DDI for SDVO: SDVO1_TVCLKIN \pm differential pair (Serial Digital Video TVOUT synchronization clock input differential pair.)	NA
DDI1_PAIR6+	C15	I PCIE	AC coupled off Module	NC	DDI for SDVO: SDVO1_FLDSTALL \pm differential pair	NA
DDI1_PAIR6-	C16				DDI for SDVO: SDVO1_FLDSTALL \pm differential pair (Serial Digital Video Field Stall input differential pair.)	NA
DDI1_CTRLCLK_AUX+	D15	I/O PCIE	AC coupled on Module	PD 100K to GND (S/W IC between Rpu/PCH)	DDI for Display Port: DP1_AUX+ Differential pairs (DP AUX+ function if DDI1_DDC_AUX_SEL is no connect) Half-duplex bi-directional AUX channel for services such as link configuration or maintenance and EDID access	DP1_AUX+ for DP
		I/O OD CMOS	3.3V / 3.3V	PU 2.2K to 3.3V, PD 100K to GND (S/W IC between Rpu/Rpd resistor)	DDI for SDVO: SDVO1_CTRLCLK (SDVO I2C clock line - to set up SDVO peripherals.) DDI for HDMI/DVI: HDMI1_CTRLCLK (HDMI/DVI I2C CTRLCLK if DDI1_DDC_AUX_SEL is pulled high)	HDMI1_CTRLCLK for HDMI or DVI

DDI Signals Descriptions						
Signal	Pin#	Pin Type	Pwr Rail /Tolerance	SH960 PU/PD	Module Base Specification R2.1 Description	COM Express Carrier Design Guide R2.0 Description
DDI1_CTRLCLK_AUX-	D16	I/O PCIE	AC coupled on Module	PU 100K to 3.3V (S/W IC between Rpu/PCH)	DDI for Display Port: DP1_AUX- Differential pairs (DP AUX- function if DDI1_DDC_AUX_SEL is no connect) Half-duplex bi-directional AUX channel for services such as link configuration or maintenance and EDID access	DP1_AUX- for DP
		I/O OD CMOS	3.3V / 3.3V	PU 2.2K to 3.3V/PU 100K to 3.3V (S/W IC between 2.2K/100K resistor)	DDI for SDVO: SDVO1_CTRLDATA (SDVO I2C data line - to set up SDVO peripherals.) DDI for HDMI/DVI: HDMI1_CTRLDATA (HDMI/DVI I2C CTRLDATA if DDI1_DDC_AUX_SEL is pulled high)	HDMI1_CTRLDATA for HDMI or DVI
DDI1_HPD	C24	ICMOS	3.3V / 3.3V	PD 1M to GND	DDI for Display Port: DP1_HPD (DP Hot-Plug Detect) DDI for HDMI/DVI: HDMI1_HPD (HDMI Hot-Plug Detect)	DP1_HPD for DP / HDMI1_HPD for HDMI or DVI
DDI1_DDC_AUX_SEL	D34	ICMOS	3.3V / 3.3V	PD 1M to GND	Selects the function of DDI1_CTRLCLK_AUX+ and DDI1_CTRLDATA_AUX-. This pin shall have a 1M pull-down to logic ground on the Module. If this input is floating the AUX pair is used for the DP AUX+/- signals. If pulled-high the AUX pair contains the CTRLCLK and CTRLDATA signals.	Selects the function of DP1_AUX±(Low) or HDMI1 DDC CLK/DATA(High) The DDC_AUX_SEL pin should be routed to pin 13 of the DisplayPort connector, to enable Dual-Mode. When HDMI/DVI is directly done on the Carrier Board, this pin shall be pulled to 3.3V with a 100k Ohm resistor to configure the AUX pairs as DDC channels.
DDI2_PAIR0+	D39	O PCIE	AC coupled off Module		DDI for Display Port: DP2_LANE 0 differential pairs	DP2_LANE0+ for DP / TMDS2_DATA2+ for HDMI or DVI
DDI2_PAIR0-	D40				DDI for HDMI/DVI: TMDS2_DATA lanes 2 differential pairs	DP2_LANE0- for DP / TMDS2_DATA2- for HDMI or DVI
DDI2_PAIR1+	D42	O PCIE	AC coupled off Module		DDI for Display Port: DP2_LANE 1 differential pairs	DP2_LANE1+ for DP / TMDS2_DATA1+ for HDMI or DVI
DDI2_PAIR1-	D43				DDI for HDMI/DVI: TMDS2_DATA lanes 1 differential pairs	DP2_LANE1- for DP / TMDS2_DATA1- for HDMI or DVI
DDI2_PAIR2+	D46	O PCIE	AC coupled off Module		DDI for Display Port: DP2_LANE 2 differential pairs	DP2_LANE2+ for DP / TMDS2_DATA0+ for HDMI or DVI
DDI2_PAIR2-	D47				DDI for HDMI/DVI: TMDS2_DATA lanes 0 differential pairs	DP2_LANE2- for DP / TMDS2_DATA0- for HDMI or DVI
DDI2_PAIR3+	D49	O PCIE	AC coupled off Module		DDI for Display Port: DP2_LANE 3 differential pairs	DP2_LANE3+ for DP / TMDS2_CLK+
DDI2_PAIR3-	D50				DDI for HDMI/DVI: TMDS2_CLK differential pairs	DP2_LANE3- for DP / TMDS2_CLK-
DDI2_CTRLCLK_AUX+	C32	I/O PCIE	AC coupled on Module	PD 100K to GND (S/W IC between Rpu/PCH)	DDI for Display Port: DP2_AUX+ Differential pairs (DP AUX+ function if DDI2_DDC_AUX_SEL is no connect) Half-duplex bi-directional AUX channel for services such as link configuration or maintenance and EDID access	DP2_AUX+ for DP
		I/O OD CMOS	3.3V / 3.3V	PU 2.2K to 3.3V, PD 100K to GND (S/W IC between Rpu/Rpd resistor)	DDI for HDMI/DVI: HDMI2_CTRLCLK (HDMI/DVI I2C CTRLCLK if DDI2_DDC_AUX_SEL is pulled high)	HDMI2_CTRLCLK for HDMI or DVI
DDI2_CTRLCLK_AUX-	C33	I/O PCIE	AC coupled on Module	PU 100K to 3.3V (S/W IC between Rpu/PCH)	DDI for Display Port: DP2_AUX- Differential pairs (DP AUX- function if DDI2_DDC_AUX_SEL is no connect) Half-duplex bi-directional AUX channel for services such as link configuration or maintenance and EDID access	DP2_AUX- for DP
		I/O OD CMOS	3.3V / 3.3V	PU 2.2K to 3.3V/PU 100K to 3.3V (S/W IC between 2.2K/100K resistor)	DDI for HDMI/DVI: HDMI2_CTRLDATA (HDMI/DVI I2C CTRLDATA if DDI2_DDC_AUX_SEL is pulled high)	HDMI2_CTRLDATA for HDMI or DVI
DDI2_HPD	D44	ICMOS	3.3V / 3.3V	PD 1M to GND	DDI for Display Port: DP2_HPD (DP Hot-Plug Detect) DDI for HDMI/DVI: HDMI2_HPD (HDMI Hot-Plug Detect)	DP2_HPD for DP / HDMI1_HPD for HDMI or DVI

DDI Signals Descriptions

Signal	Pin#	Pin Type	Pwr Rail /Tolerance	SH960 PU/PD	Module Base Specification R2.1 Description	COM Express Carrier Design Guide R2.0 Description
DDI2_DDC_AUX_SEL	C34	I CMOS	3.3V / 3.3V	PD 1M to GND	Selects the function of DDI2_CTRLCLK_AUX+ and DDI2_CTRLDATA_AUX-. This pin shall have a 1M pull-down to logic ground on the Module. If this input is floating the AUX pair is used for the DP AUX+/- signals. If pulled-high the AUX pair contains the CTRLCLK and CTRLDATA signals.	Selects the function of DP2 AUX±(Low) or HDMI2 DDC CLK/DATA(High) The DDC_AUX_SEL pin should be routed to pin 13 of the DisplayPort connector, to enable Dual-Mode. When HDMI/DVI is directly done on the Carrier Board, this pin shall be pulled to 3.3V with a 100k Ohm resistor to configure the AUX pairs as DDC channels.
DDIB_PAIR0+	C39	O PCIE	AC coupled off Module		DDI for Display Port: DP3_LANE 0 differential pairs	DP3_LANE0+ for DP / TMDS3_DATA2+ for HDMI or DVI
DDIB_PAIR0-	C40				DDI for HDMI/DVI: TMDS3_DATA lanes 2 differential pairs	DP3_LANE0- for DP / TMDS3_DATA2- for HDMI or DVI
DDIB_PAIR1+	C42	O PCIE	AC coupled off Module		DDI for Display Port: DP3_LANE 1 differential pairs	DP3_LANE1+ for DP / TMDS3_DATA1+ for HDMI or DVI
DDIB_PAIR1-	C43				DDI for HDMI/DVI: TMDS3_DATA lanes 1 differential pairs	DP3_LANE1- for DP / TMDS3_DATA1- for HDMI or DVI
DDIB_PAIR2+	C46	O PCIE	AC coupled off Module		DDI for Display Port: DP3_LANE 2 differential pairs	DP3_LANE2+ for DP / TMDS3_DATA0+ for HDMI or DVI
DDIB_PAIR2-	C47				DDI for HDMI/DVI: TMDS3_DATA lanes 0 differential pairs	DP3_LANE2- for DP / TMDS3_DATA0- for HDMI or DVI
DDIB_PAIR3+	C49	O PCIE	AC coupled off Module		DDI for Display Port: DP3_LANE 3 differential pairs	DP3_LANE3+ for DP / TMDS3_CLK+
DDIB_PAIR3-	C50				DDI for HDMI/DVI: TMDS3_CLK differential pairs	DP3_LANE3- for DP / TMDS3_CLK-
DDIB_CTRLCLK_AUX+	C36	I/O PCIE	AC coupled on Module	PD 100K to GND (S/W IC between Rpu/PCH)	DDI for Display Port: DP3_AUX+ Differential pairs (DP AUX+ function if DDIB_DDC_AUX_SEL is no connect) Half-duplex bi-directional AUX channel for services such as link configuration or maintenance and EDID access	DP3_AUX+ for DP
		I/O OD CMOS	3.3V / 3.3V	PU 2.2K to 3.3V, PD 100K to GND (S/W IC between Rpu/Rpd resistor)	DDI for HDMI/DVI: HDMI3_CTRLCLK (HDMI/DVI I2C CTRLCLK if DDIB_DDC_AUX_SEL is pulled high)	HDMI3_CTRLCLK for HDMI or DVI
DDIB_CTRLCLK_AUX-	C37	I/O PCIE	AC coupled on Module	PU 100K to 3.3V (S/W IC between Rpu/PCH)	DDI for Display Port: DP3_AUX- Differential pairs (DP AUX- function if DDIB_DDC_AUX_SEL is no connect)	DP3_AUX- for DP
		I/O OD CMOS	3.3V / 3.3V	PU 2.2K to 3.3V/PU 100K to 3.3V (S/W IC between 2.2K/100K resistor)	DDI for HDMI/DVI: HDMI3_CTRLDATA (HDMI/DVI I2C CTRLDATA if DDIB_DDC_AUX_SEL is pulled high)	HDMI3_CTRLDATA for HDMI or DVI
DDIB_HPD	C44	I CMOS	3.3V / 3.3V	PD 1MΩ to GND	DDI for Display Port: DP3_HPD (DP Hot-Plug Detect) DDI for HDMI/DVI: HDMI3_HPD (HDMI Hot-Plug Detect)	DP3_HPD for DP / HDMI1_HPD for HDMI or DVI
DDIB_DDC_AUX_SEL	C38	I CMOS	3.3V / 3.3V	PD 1MΩ to GND	Selects the function of DDIB_CTRLCLK_AUX+ and DDIB_CTRLDATA_AUX-. This pin shall have a 1M pull-down to logic ground on the Module. If this input is floating the AUX pair is used for the DP AUX+/- signals. If pulled-high the AUX pair contains the CTRLCLK and CTRLDATA signals.	Selects the function of DP3 AUX±(Low) or HDMI3 DDC CLK/DATA(High) The DDC_AUX_SEL pin should be routed to pin 13 of the DisplayPort connector, to enable Dual-Mode. When HDMI/DVI is directly done on the Carrier Board, this pin shall be pulled to 3.3V with a 100k Ohm resistor to configure the AUX pairs as DDC channels.

Serial Interface Signals Descriptions

Signal	Pin#	Pin Type	Pwr Rail /Tolerance	SH960 PU/PD	Module Base Specification R2.1 Description	COM Express Carrier Design Guide R2.0 Description
SER0_TX	A98	O CMOS	5V/12V		General purpose serial port 0 transmitter	Transmit Line for Serial Port 0 ; PD 4.7K Ω
SER0_RX	A99	I CMOS	5V/12V	PU 10K Ω to 3.3V	General purpose serial port 0 receiver	Receive Line for Serial Port 0
SER1_TX	A101	O CMOS	5V/12V		General purpose serial port 1 transmitter	Transmit Line for Serial Port 1 ; PD 4.7K Ω
SER1_RX	A102	I CMOS	5V/12V	PU 10K Ω to 3.3V	General purpose serial port 1 receiver	Receive Line for Serial Port 1

I2C Signal Descriptions

Signal	Pin#	Pin Type	Pwr Rail /Tolerance	SH960 PU/PD	Module Base Specification R2.1 Description	COM Express Carrier Design Guide R2.0 Description
I2C_CLK	B33	I/O OD CMOS	3.3V Suspend/3.3V	PU 2.2K to 3.3V Suspend	General purpose I2C port clock output	General Purpose I2C Clock output
I2C_DAT	B34	I/O OD CMOS	3.3V Suspend/3.3V	PU 2.2K to 3.3V Suspend	General purpose I2C port data I/O line	General Purpose I2C data I/O line.

Miscellaneous Signal Descriptions

Signal	Pin#	Pin Type	Pwr Rail /Tolerance	SH960 PU/PD	Module Base Specification R2.1 Description	COM Express Carrier Design Guide R2.0 Description
SPKR	B32	O CMOS	3.3V / 3.3V		Output for audio enunciator - the "speaker" in PC-AT systems. This port provides the PC beep signal and is mostly intended for debugging purposes.	Output used to control an external FET or a logic gate to drive an external PC speaker.
WDT	B27	O CMOS	3.3V / 3.3V		Output indicating that a watchdog time-out event has occurred.	Output indicating that a watchdog time-out event has occurred.
FAN_PWMOUT	B101	O CMOS	3.3V / 12V	RSV PD 100K Ω to GND	Fan speed control. Uses the Pulse Width Modulation (PWM) technique to control the fan's RPM.	Fan speed control. Uses the Pulse Width Modulation (PWM) technique to control the fan's RPM.
FAN_TACHIN	B102	I OD CMOS	3.3V / 12V	PU 47K Ω to 3.3V	Fan tachometer input for a fan with a two pulse output.	Fan tachometer input for a fan with a two pulse output.
TPM_PP	A96	I CMOS	3.3V / 3.3V	PD 100K Ω to GND.	Trusted Platform Module (TPM) Physical Presence pin. Active high. TPM chip has an internal pull down. This signal is used to indicate Physical Presence to the TPM.	Trusted Platform Module (TPM) Physical Presence pin. Active high. TPM chip has an internal pull down. This signal is used to indicate Physical Presence to the TPM.

Power and System Management Signals Descriptions

Signal	Pin#	Pin Type	Pwr Rail /Tolerance	SH960 PU/PD	Module Base Specification R2.1 Description	COM Express Carrier Design Guide R2.0 Description
PWRBTN#	B12	I CMOS	3.3V Suspend/3.3V	PU 10K Ω to 3.3V Suspend	A falling edge creates a power button event. Power button events can be used to bring a system out of S5 soft off and other suspend states, as well as powering the system down.	Power button low active signal used to wake up the system from S5 state (soft off). This signal is triggered on the falling edge.
SYS_RESET#	B49	I CMOS	3.3V Suspend/3.3V	PU 10K Ω to 3.3V Suspend	Reset button input. Active low request for Module to reset and reboot. May be falling edge sensitive. For situations when SYS_RESET# is not able to reestablish control of the system, PWR_OK or a power cycle may be used.	Reset button input. Active low request for Module to reset and reboot. May be falling edge sensitive. For situations when SYS_RESET# is not able to reestablish control of the system, PWR_OK or a power cycle may be used.
CB_RESET#	B50	O CMOS	3.3V Suspend/3.3V	PD 100K Ω to GND	Reset output from Module to Carrier Board. Active low. Issued by Module chipset and may result from a low SYS_RESET# input, a low PWR_OK input, a VCC_12V power input that falls below the minimum specification, a watchdog timeout, or may be initiated by the Module software.	Reset output signal from Module to Carrier Board. This signal may be driven low by the Module to reset external components located on the Carrier Board.
PWR_OK	B24	I CMOS	3.3V / 3.3V	PU 10K Ω to 3.3V	Power OK from main power supply. A high value indicates that the power is good. This signal can be used to hold off Module startup to allow Carrier based FPGAs or other configurable devices time to be programmed.	Power OK status signal generated by the ATX power supply to notify the Module that the DC operating voltages are within the ranges required for proper operation.

Signal	Pin#	Pin Type	Pwr Rail /Tolerance	SH960 PU/PD	Module Base Specification R2.1 Description	COM Express Carrier Design Guide R2.0 Description
SUS_STAT#	B18	O CMOS	3.3V Suspend/3.3V		Indicates imminent suspend operation; used to notify LPC devices.	Suspend status signal to indicate that the system will be entering a low power state soon. It can be used by other peripherals on the Carrier Board as an indication that they should go into power-down mode.
SUS_S3#	A15	O CMOS	3.3V Suspend/3.3V	PD 100KΩ to GND	Indicates system is in Suspend to RAM state. Active low output. An inverted copy of SUS_S3# on the Carrier Board may be used to enable the non-standby power on a typical ATX supply.	S3 Sleep control signal indicating that the system resides in S3 state (Suspend to RAM).
SUS_S4#	A18	O CMOS	3.3V Suspend/3.3V	PD 100KΩ to GND	Indicates system is in Suspend to Disk state. Active low output.	S4 Sleep control signal indicating that the system resides in S4 state (Suspend to Disk).
SUS_S5#	A24	O CMOS	3.3V Suspend/3.3V	PD 100KΩ to GND	Indicates system is in Soft Off state.	S5 Sleep Control signal indicating that the system resides in S5 State (Soft Off).
WAKE0#	B66	I CMOS	3.3V Suspend/3.3V	PU 10KΩ to 3.3V Suspend	PCI Express wake up signal.	PCI Express wake-up event signal.
WAKE1#	B67	I CMOS	3.3V Suspend/3.3V	Integrate PU @PCH	General purpose wake up signal. May be used to implement wake-up on PS2 keyboard or mouse activity.	General purpose wake-up signal.
BATLOW #	A27	I CMOS	3.3V Suspend/ 3.3V	PU 10KΩ to 3.3V Suspend	Indicates that external battery is low. This port provides a battery-low signal to the Module for orderly transitioning to power saving or power cut-off ACPI modes.	Battery low input. This signal may be driven low by external circuitry to signal that the system battery is low. It also can be used to signal some other external power management event.
LID#	A103	I OD CMOS	3.3V Suspend/12V	PU 47KΩ to 3.3V Suspend	LID switch. Low active signal used by the ACPI operating system for a LID switch.	LID switch. Low active signal used by the ACPI operating system for a LID switch.
SLEEP#	B103	I OD CMOS	3.3V Suspend/12V	PU 47KΩ to 3.3V Suspend	Sleep button. Low active signal used by the ACPI operating system to bring the system to sleep state or to wake it up again.	Sleep button. Low active signal used by the ACPI operating system to bring the system to sleep state or to wake it up again.

Thermal Protection Signals Descriptions

Signal	Pin#	Pin Type	Pwr Rail /Tolerance	SH960 PU/PD	Module Base Specification R2.1 Description	COM Express Carrier Design Guide R2.0 Description
THRM#	B35	I CMOS	3.3V / 3.3V	PU 10KΩ to 3.3V	Input from off-Module temp sensor indicating an over-temp situation.	Thermal Alarm active low signal generated by the external hardware to indicate an over temperature situation. This signal can be used to initiate thermal throttling.
THRMTRIP#	A35	O CMOS	3.3V / 3.3V	PU 10KΩ to 3.3V	Active low output indicating that the CPU has entered thermal shutdown.	Thermal Trip indicates an overheating condition of the processor. If 'THRMTRIP#' goes active the system immediately transitions to the S5 State (Soft Off).

SMBUS Signals Descriptions

Signal	Pin#	Pin Type	Pwr Rail /Tolerance	SH960 PU/PD	Module Base Specification R2.1 Description	COM Express Carrier Design Guide R2.0 Description
SMB_CK	B13	I/O OD CMOS	3.3V Suspend/3.3V	PU 2.2KΩ to 3.3V Suspend	System Management Bus bidirectional clock line.	System Management Bus bidirectional clock line
SMB_DAT	B14	I/O OD CMOS	3.3V Suspend/3.3V	PU 2.2KΩ to 3.3V Suspend	System Management Bus bidirectional data line.	System Management bidirectional data line.
SMB_ALERT#	B15	I CMOS	3.3V Suspend/3.3V	PU 2.2KΩ to 3.3V Suspend	System Management Bus Alert – active low input can be used to generate an SMI# (System Management Interrupt) or to wake the system.	System Management Bus Alert

GPIO Signals Descriptions

Signal	Pin#	Pin Type	Pwr Rail /Tolerance	SH960 PU/PD	Module Base Specification R2.1 Description	COM Express Carrier Design Guide R2.0 Description
GPO0	A93	O CMOS	3.3V / 3.3V		General purpose output pins. Upon a hardware reset, these outputs should be low.	General Purpose Outputs for system specific usage.
GPO1	B54					
GPO2	B57					
GPO3	B63					
GPI0	A54	I CMOS	3.3V / 3.3V	PU 47K Ω to 3.3V	General purpose input pins. Pulled high internally on the Module.	General Purpose Input for system specific usage. The signals are pulled up by the Module.
GPI1	A63			PU 47K Ω to 3.3V		
GPI2	A67			PU 47K Ω to 3.3V		
GPI3	A85			PU 47K Ω to 3.3V		

Power and GND Signal Descriptions

Signal	Pin#	Pin Type	Pwr Rail /Tolerance	SH960 PU/PD	Module Base Specification R2.1 Description	COM Express Carrier Design Guide R2.0 Description
VCC_12V	A104~A109 B104~B109 C104~C109 D104~D109	Power			Primary power input: +12V nominal. All available VCC_12V pins on the connector(s) shall be used.	
VCC_5V_SBY	B84~B87	Power			Standby power input: +5.0V nominal. If VCC5_SBY is used, all available VCC_5V_SBY pins on the connector(s) shall be used. Only used for standby and suspend functions. May be left unconnected if these functions are not used in the system design.	
VCC_RTC	A47	Power			Real-time clock circuit-power input. Nominally +3.0V.	
GND	A1, A11, A21, A31, A41, A51, A57, A60, A66, A70, A80, A90, A100, A110, B1, B11, B21, B31, B41, B51, B60, B70, B80, B90, B100, B110, C1, C2, C5, C8, C11, C14, C21, C31, C41, C51, C60, C70, C73, C76, C80, C84, C87, C90, C93, C96, C100, C103, C110, D1, D2, D5, D8, D11, D14, D21, D31, D41, D51, D60, D67, D70, D73, D76, D80, D84, D87, D90, D93, D96, D100, D103, D110	Power			Ground - DC power and signal and AC signal return path. All available GND connector pins shall be used and tied to Carrier Board GND plane.	

Module type Signal Descriptions

Signal	Pin#	Pin Type	Pwr Rail /Tolerance	SH960 PU/PD	Module Base Specification R2.1 Description	COM Express Carrier Design Guide R2.0 Description																												
TYPE0#	C54	PDS		N.C.	<table border="0"> <tr> <td>TYPE2#</td> <td>TYPE1#</td> <td>TYPE0#</td> <td></td> </tr> <tr> <td>X</td> <td>X</td> <td>X</td> <td>pin out Type 1</td> </tr> <tr> <td>NC</td> <td>NC</td> <td>NC</td> <td>pin out Type 2</td> </tr> <tr> <td>NC</td> <td>NC</td> <td>GND</td> <td>pin out Type 3 (no IDE)</td> </tr> <tr> <td>NC</td> <td>GND</td> <td>NC</td> <td>pin out Type 4 (no PCI)</td> </tr> <tr> <td>NC</td> <td>GND</td> <td>GND</td> <td>pin out Type 5 (no IDE, no PCI)</td> </tr> <tr> <td>GND</td> <td>NC</td> <td>NC</td> <td>pin out Type 6 (no IDE, no PCI)</td> </tr> </table>	TYPE2#	TYPE1#	TYPE0#		X	X	X	pin out Type 1	NC	NC	NC	pin out Type 2	NC	NC	GND	pin out Type 3 (no IDE)	NC	GND	NC	pin out Type 4 (no PCI)	NC	GND	GND	pin out Type 5 (no IDE, no PCI)	GND	NC	NC	pin out Type 6 (no IDE, no PCI)	<p>The Type pins indicate the COM Express pin-out type of the Module. To indicate the Module's pin-out type, the pins are either not connected or strapped to ground on the Module. The Carrier Board has to implement additional logic, which prevents the system to switch power on, if a Module with an incompatible pin-out type is detected.</p>
TYPE2#	TYPE1#	TYPE0#																																
X	X	X	pin out Type 1																															
NC	NC	NC	pin out Type 2																															
NC	NC	GND	pin out Type 3 (no IDE)																															
NC	GND	NC	pin out Type 4 (no PCI)																															
NC	GND	GND	pin out Type 5 (no IDE, no PCI)																															
GND	NC	NC	pin out Type 6 (no IDE, no PCI)																															
TYPE1#	C57	PDS	N.C.																															
TYPE2#	D57	PDS	PD 0Ω to GND																															
TYPE10#	A97	PDS		N.C.	<p>Dual use pin. Indicates to the Carrier Board that a Type 10 Module is installed. Indicates to the Carrier that a Rev 1.0/2.0 Module is installed</p> <p>TYPE10#</p> <p>NC Pin-out R2.0 PD Pin-out Type 10 pull down to ground with 47K resistor 12V Pin-out R1.0</p> <p>This pin is reclaimed from the VCC_12V pool. In R1.0 Modules this pin will connect to other VCC_12V pins. In R2.0 this pin is defined as a no connect for types 1-6. A Carrier can detect a R1.0 Module by the presence of 12V on this pin. R2.0 Module types 1-6 will no connect this pin. Type 10 Modules shall pull this pin to ground through a 47K resistor.</p>	<p>Indicates to the Carrier Board that a Type 10 Module is installed. Indicates to the Carrier Board, that a Rev 1.0/2.0 Module is installed.</p> <p>TYPE10#</p> <p>NC Pin-out R2.0 PD Pin-out Type 10 pull down to ground with 47k 12V Pin-out R1.0</p>																												

Standby Power LED

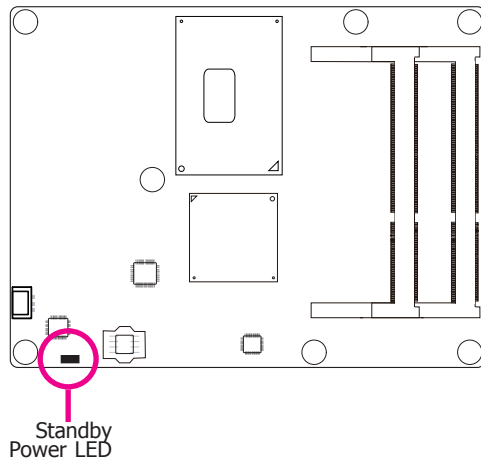

This LED will light up when the system is in the standby mode.

Cooling Option

Heat Spreader with Heat Sink and Fan



Note:

The system board used in the following illustrations may not resemble the actual board. These illustrations are for reference only.



Top View of the Heat Sink

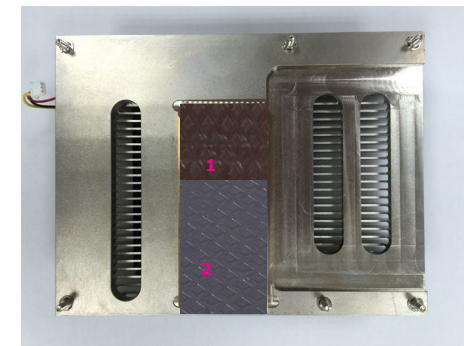

Bottom View of the Heat Sink

- "1" and "2" denote the locations of the thermal pads designed to contact the corresponding components that are on the SH960 COMe board.



Important:

Remove the plastic covering from the thermal pads prior to mounting the heat sink onto the SH960 COMe board.

Installing SH960-CM236/QM170/HM170 onto a Carrier Board



Important:

The carrier board used in this section is for reference purposes only and may not resemble your actual carrier board. These illustrations are mainly to guide you on how to install SH960-CM236/QM170/HM170 onto the carrier board of your choice.

1. Grasp the SH960 COMe board by its edges and position it on top of the carrier board with its mounting holes aligned with the bolts on the carrier board. This helps align the COM Express connectors of the two boards with each other.

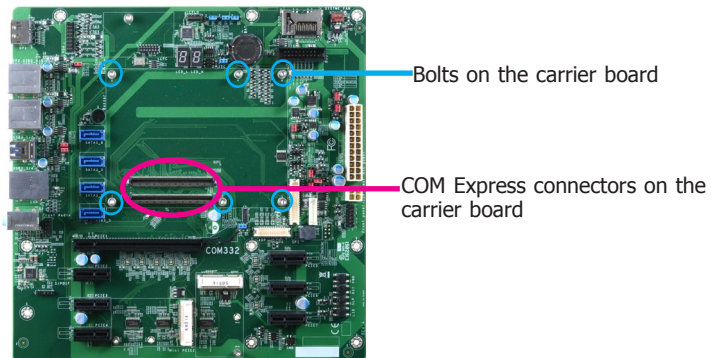
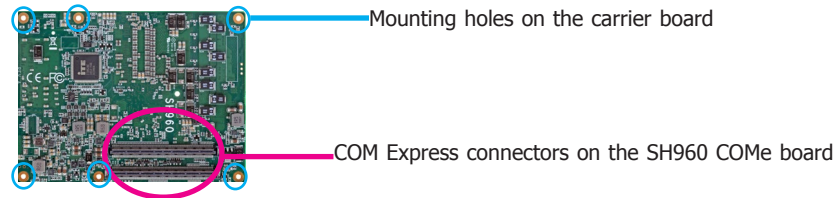

2. Install the SH960 COMe board by applying even pressure to the lower end of the module first, and then push down the upper end of the module. You will feel a distinctive click that indicates the module is securely locked into position.

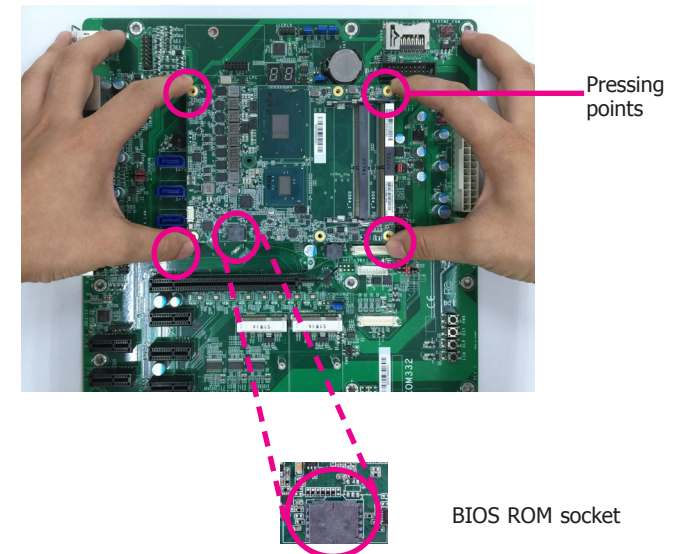
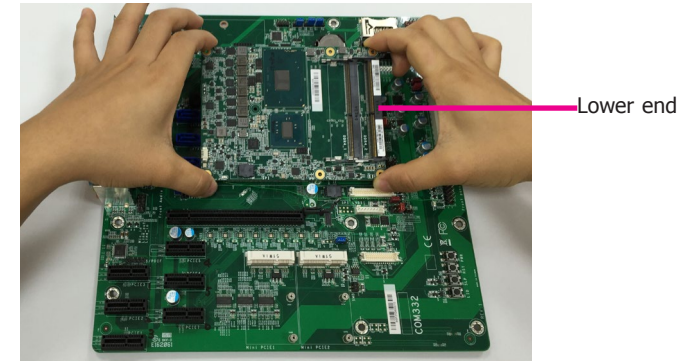

Note:

The illustrations above show the pressing points of the COMe board onto the carrier board. Be careful when pressing the module, it may damage the socket.

- Use the provided spring screws to install the heat sink onto the module. Align the mounting holes of the heat sink with the mounting holes of the module and screw on the heat sink in sequence as indicated in the following image. This will avoid damaging the CPU.

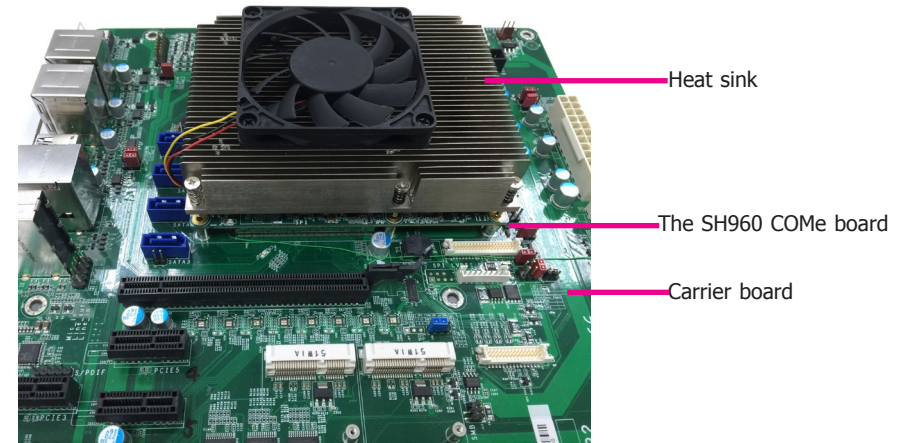
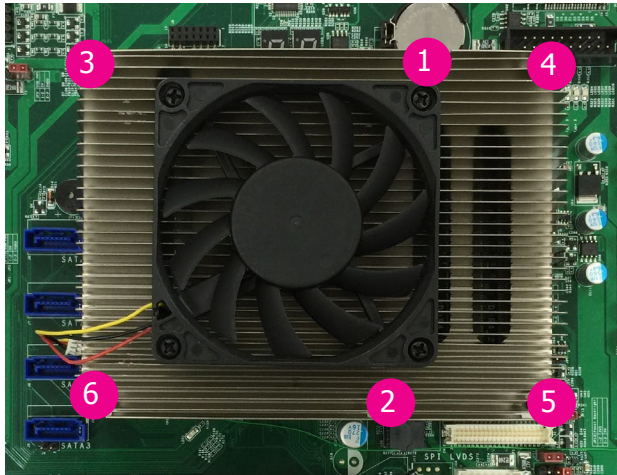

Side View of the Installed Heat sink, Module, and Carrier Board

- Connect the heat sink and fan's cable to the fan connector on the SH960 COMe board.

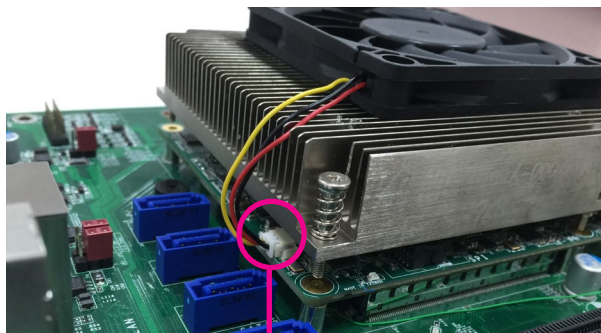

Fan connector

Chapter 4 - BIOS Setup

Overview

The BIOS is a program that takes care of the basic level of communication between the CPU and peripherals. It contains codes for various advanced features found in this system board. The BIOS allows you to configure the system and save the configuration in a battery-backed CMOS so that the data retains even when the power is off. In general, the information stored in the CMOS RAM of the EEPROM will stay unchanged unless a configuration change has been made such as a hard drive replaced or a device added. It is possible that the CMOS battery will fail causing CMOS data loss. If this happens, you need to install a new CMOS battery and reconfigure the BIOS settings.

Note:

The BIOS is constantly updated to improve the performance of the system board; therefore the BIOS screens in this chapter may not appear the same as the actual one. These screens are for reference purpose only.

Default Configuration

Most of the configuration settings are either predefined according to the Load Optimal Defaults settings which are stored in the BIOS or are automatically detected and configured without requiring any actions. There are a few settings that you may need to change depending on your system configuration.

Entering the BIOS Setup Utility

The BIOS Setup Utility can only be operated from the keyboard and all commands are keyboard commands. The commands are available at the right side of each setup screen.

The BIOS Setup Utility does not require an operating system to run. After you power up the system, the BIOS message appears on the screen and the memory count begins. After the memory test, the message "Press DEL to run setup" will appear on the screen. If the message disappears before you respond, restart the system or press the "Reset" button. You may also restart the system by pressing the <Ctrl> <Alt> and keys simultaneously.

Legends

KEYs	Function
F1	Help
<Esc>	Exit
Up and Down Arrows	Select Item
Right and Left Arrows	Select Item
<F5>/<F6>	Change Values
<Enter>	Select ► Submenu
<F9>	Setup Defaults
<F10>	Save and Exit

Scroll Bar

When a scroll bar appears to the right of the setup screen, it indicates that there are more available fields not shown on the screen. Use the up and down arrow keys to scroll through all the available fields.

Submenu

When "►" appears on the left of a particular field, it indicates that a submenu which contains additional options are available for that field. To display the submenu, move the highlight to that field and press <Enter>.

Insyde BIOS Setup Utility

Main

The Main menu is the first screen that you will see when you enter the BIOS Setup Utility.

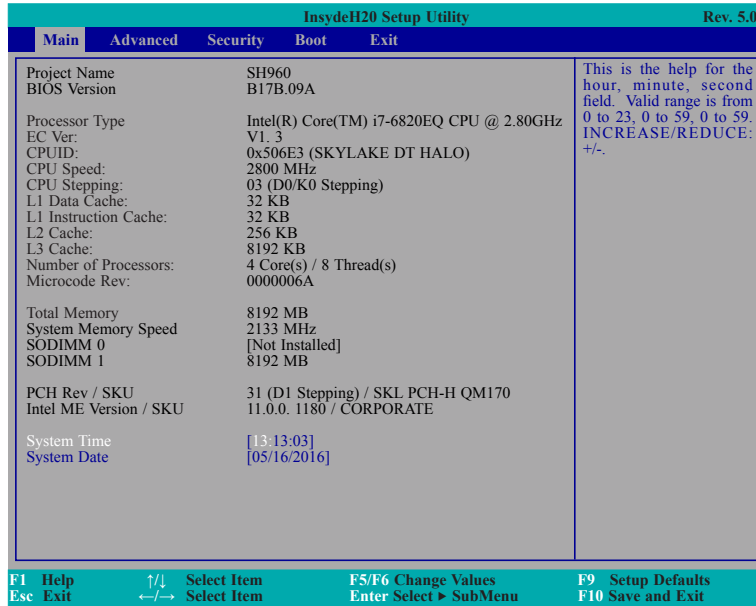

System Date

The date format is <month>, <date>, <year>. Day displays a day, from Sunday to Saturday. Month displays the month, from January to December. Date displays the date, from 1 to 31. Year displays the year, from 1980 to 2099.

System Time

The time format is <hour>, <minute>, <second>. The time is based on the 24-hour military-time clock. For example, 1 p.m. is 13:00:00. Hour displays hours from 00 to 23. Minute displays minutes from 00 to 59. Second displays seconds from 00 to 59.

Advanced

The Advanced menu allows you to configure your system for basic operation. Some entries are defaults required by the system board, while others, if enabled, will improve the performance of your system or let you set some features according to your preference.



Important:

Setting incorrect field values may cause the system to malfunction.

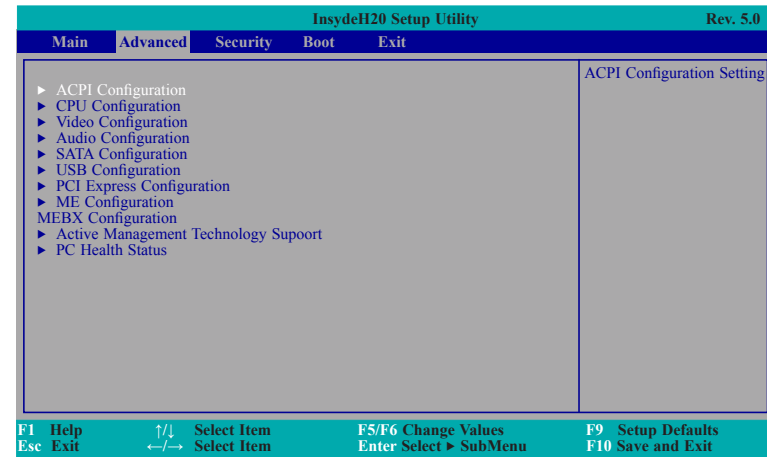

ACPI Settings

This section configures the ACPI settings.

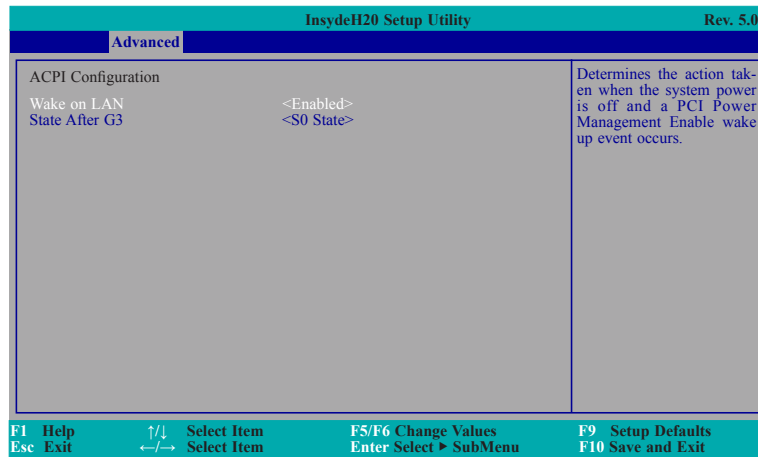

Wake on LAN

Set this field to enable the automatic wake-up of the system via the onboard LAN or via a LAN card that supports the remote wake up function.

State After G3

Specify what state the system should be in when power is re-applied after a power failure (G3, the mechanical-off, state).

S0 State The system is in working state.

S5 State The system is in soft-off state.

CPU Configuration

This section configures the CPU.

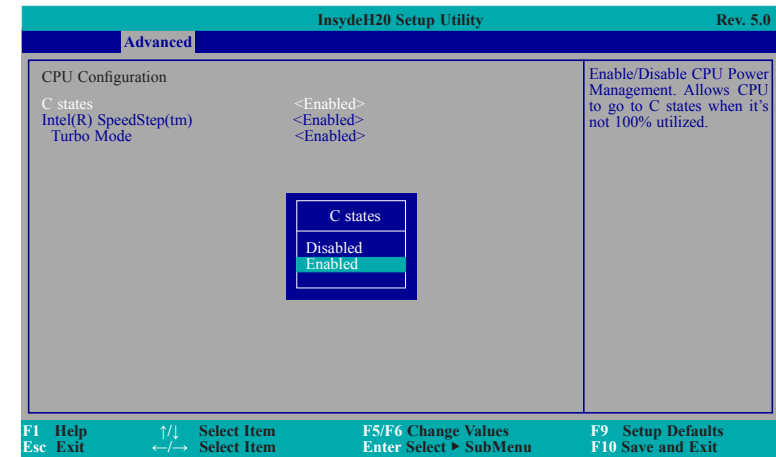

C States

Enable or disable CPU Power Management. It allows the CPU to go to C states when it's not 100% utilized.



Note:

With some linux kernel OS such as Debian, CentOS, Ubuntu, this field needs to be set to "disabled" before installation.

Intel® SpeedStep™

Enable or disable the Enhanced Intel SpeedStep® Technology, which allows more than two frequency ranges to be supported.

Turbo Mode

Enable or disable processor turbo mode (requires that EMTTM is enabled too), which allows the processor core to automatically run faster than the base frequency when the processor's power, temperature, and specification are within the limits of TDP.

Video Configuration

This section configures the video settings.

Primary Display

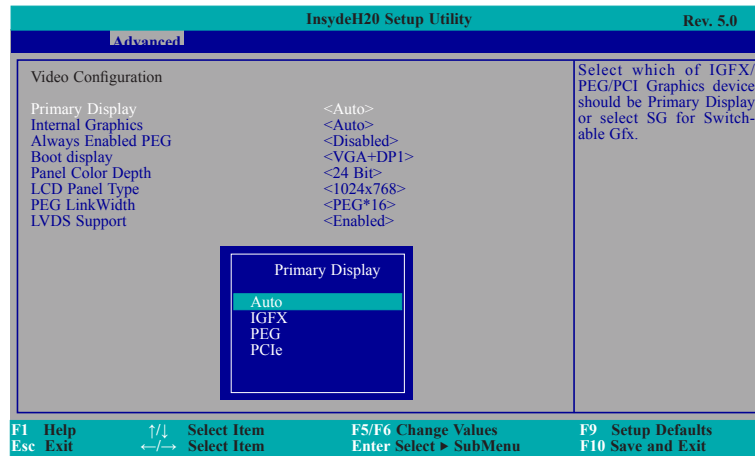

Primary Display

Select either integrated graphics function (IGFX) or PCIe graphics device (PEG) to be the primary display. Note that this option is only available if the boot type is set to "Dual" or "UEFI".

Internal Graphics Device

Enable or disable the integrated graphics function (IGFX).

Always Enabled PEG

Always enable the PCIe graphics device function.

Boot display

Set the display device combination during boot. Note this option is only available when the boot type is set to "Dual" or "Legacy".

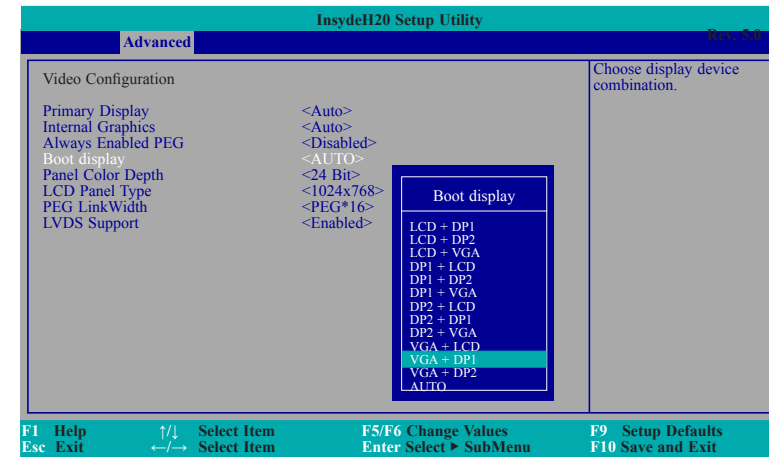

Note:

VGA is transferred from DDI3 port interface.

Panel Color Depth

Select the LFP panel color depth: 18 bit, 24 bit, 36 bit, and 48 bit.

LCD Panel Type

Select the LCD panel type.

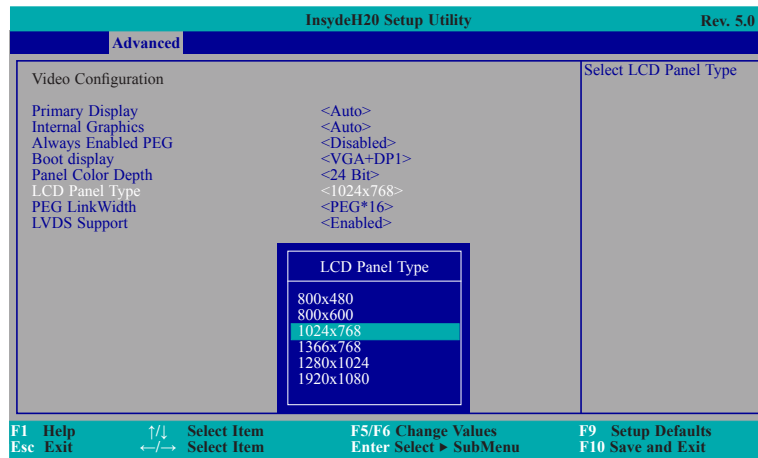

PEG LinkWidth

Select the PEG Port LinkWidth: PEG 2*8 or PEG*16.

LVDS Support

Turn on or off LVDS.

Audio Configuration

This section configures the audio settings.

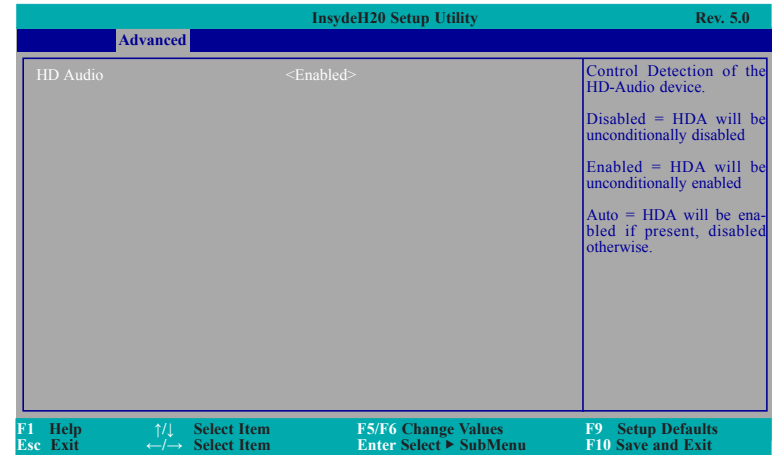

HD Audio

Control the detection of the High-Definition audio device.

Disabled

HDA will be unconditionally disabled.

Enabled

HDA will be unconditionally enabled.

Auto

HDA will be enabled if present, disabled otherwise.

SATA Configuration

This section configures the SATA controllers.

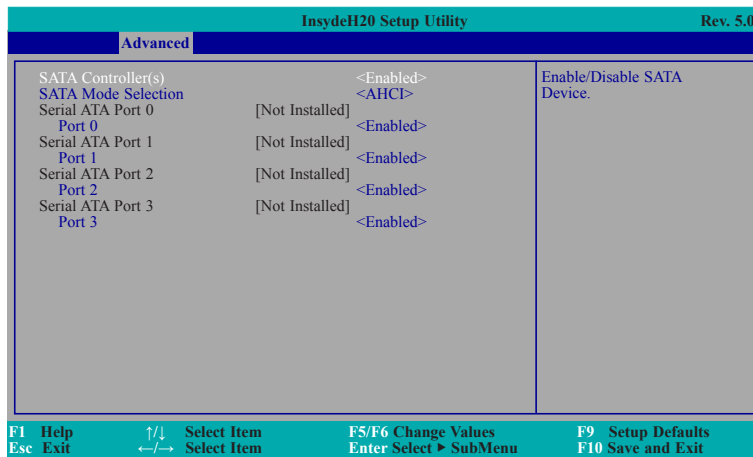

SATA Controller(s)

Enable or disable Serial ATA devices.

SATA Mode Selection

The mode selection determines how the SATA controller(s) operates.

AHCI Mode

This option allows the Serial ATA devices to use AHCI (Advanced Host Controller Interface).

RAID Mode

This option allows you to create RAID using Intel® Rapid Storage Technology on the Serial ATA devices. Please refer to Chapter 6 for more information.

Serial ATA Port 0, 1, 2, and 3

Enable or disable each serial ATA port.

USB Configuration

This section configures parameters for USB devices.

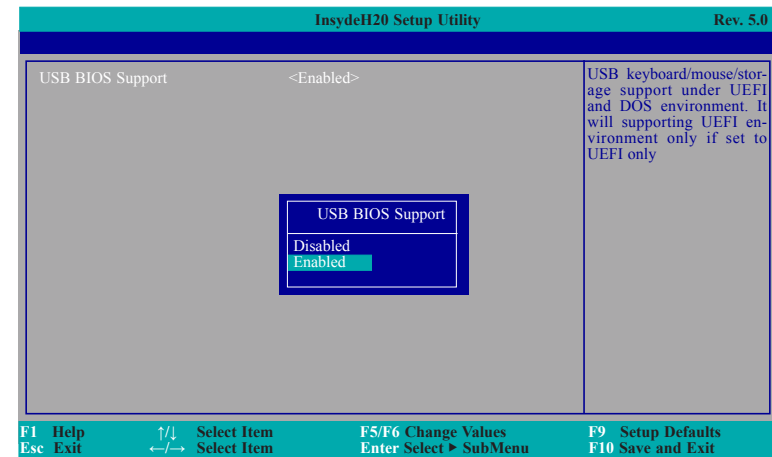

USB BIOS Support

Disabled

Disable USB keyboard/mouse/storage support.

Enabled

Enable USB keyboard/mouse/storage support under UEFI and DOS environment.

PCI Express Configuration

This section configures settings of the PCIe root ports.

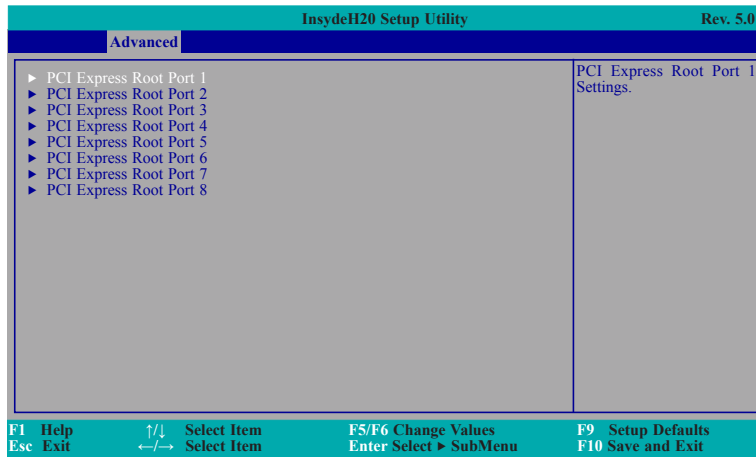

PCI Express Root Port 1 to PCI Express Root Port 8

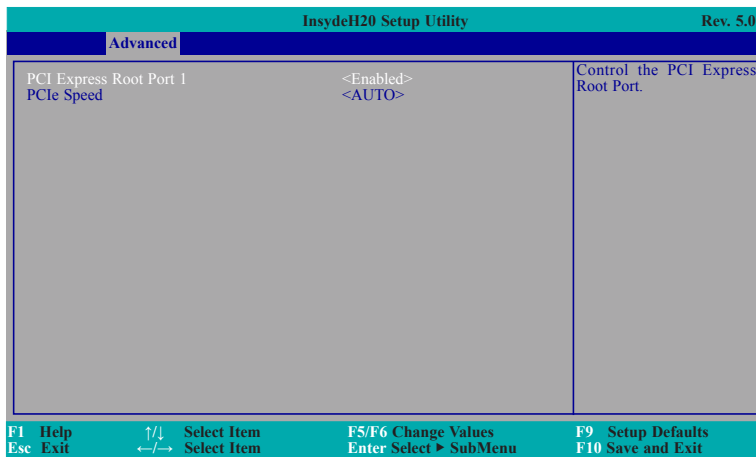

PCI Express Root Port

Enable or disable each PCI Express Root Port.

PCIe Speed

Select the speed of the PCI Express Root Port: Auto, Gen1 (2.5 GT/s), Gen2 (5 GT/s) or Gen3 (8 GT/s).

ME Configuration

This section configures settings of flashing the Intel® Management Engine (ME).

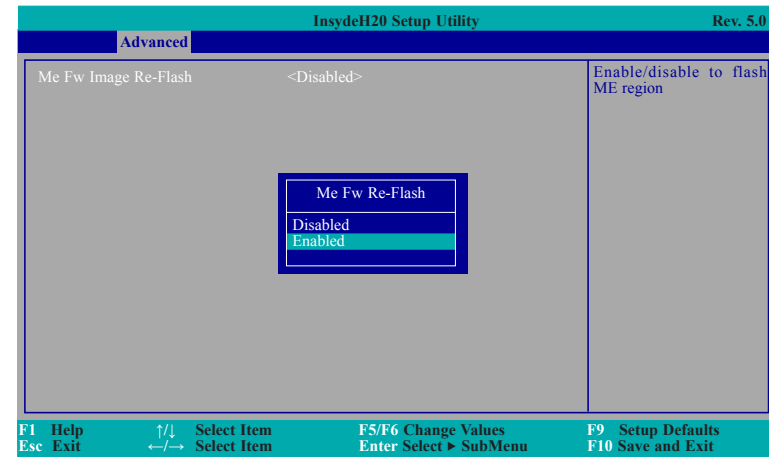

Me Fw Image Re-Flash

Enable or disable flashing of the Intel® Management Engine (ME) region of the BIOS.

Active Management Technology Support

The section allows you to enable or disable the Intel® Active Management Technology (Intel® AMT) BIOS extension. Refer to chapter 7 for more information. Note that SKUs with the Intel® HM170 chipset or Intel® Core™ i3 and Celeron® processors do not support AMT.

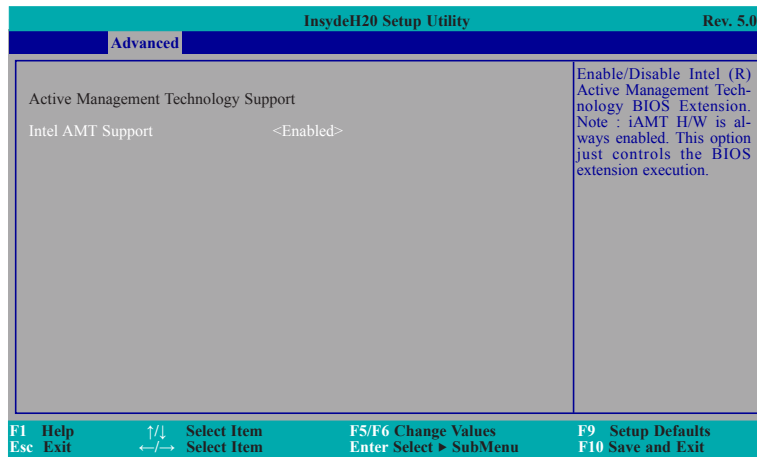

Intel AMT Support

Enable or disable the Intel® Active Management Technology (AMT).

PC Health Status

This section configures the Embedded Controller (EC) settings.

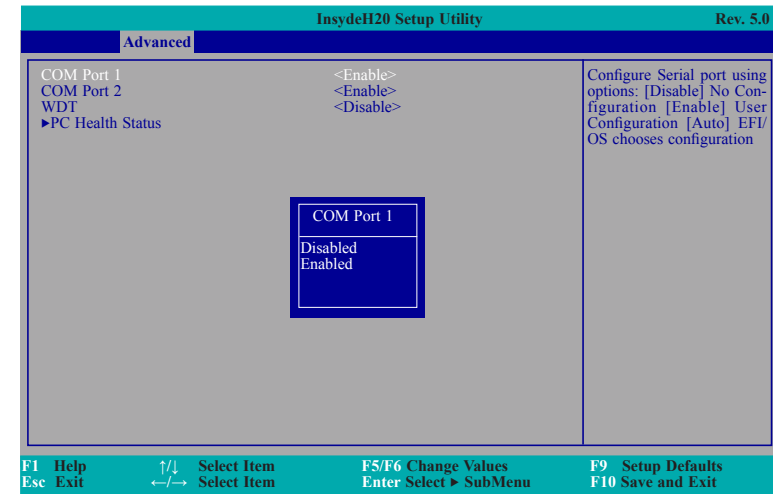

Serial Port 1 to Serial Port 2

Configure the settings of the serial ports.

Disable Disable this serial port

Enable Enable this serial port

WDT

Enable or disable the watchdog function. A counter will appear if you select to enable WDT. Input any value between 1 to 255 seconds.

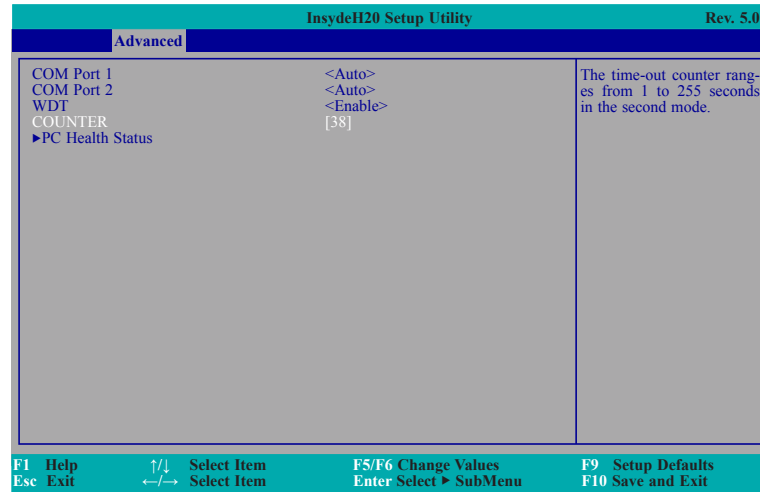
**PC Health Status**

This screen displays PC health status such as the CPU temperature and fan speeds.

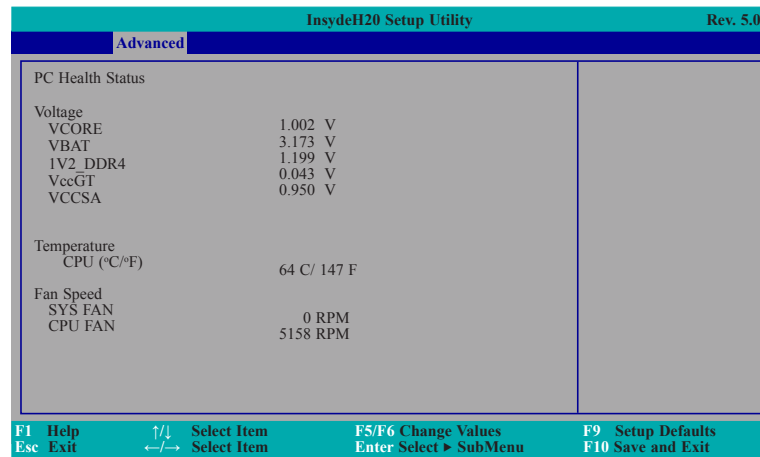
**Security**

This section configures security-related settings.

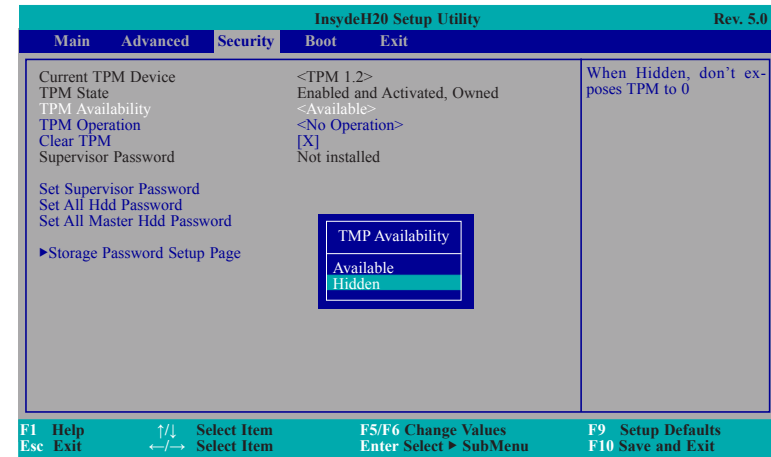
**TPM Availability**

Show or hide the TPM availability and its configurations.

TPM Operation

Enable or disable the TPM function. It displays the following options:

- No Operation: No changes to the current state.
- Disable: Disable and deactivate TPM.
- Enable: Enable and activate TPM.

Clear TPM

Remove all TPM context associated with a specific owner.

Set Supervisor Password

Set the administrative password for entering the BIOS utility or upon entering the power-on self-test (POST) process. The length of the password must be greater than 1 character and less than or equal to 10 characters.

Power on Password

If you select to set the supervisor password, this option will be shown. Enable or disable the prompt for password at boot.

Set Supervisor Password

Set the supervisor's password and the length of the password must be greater than one character.

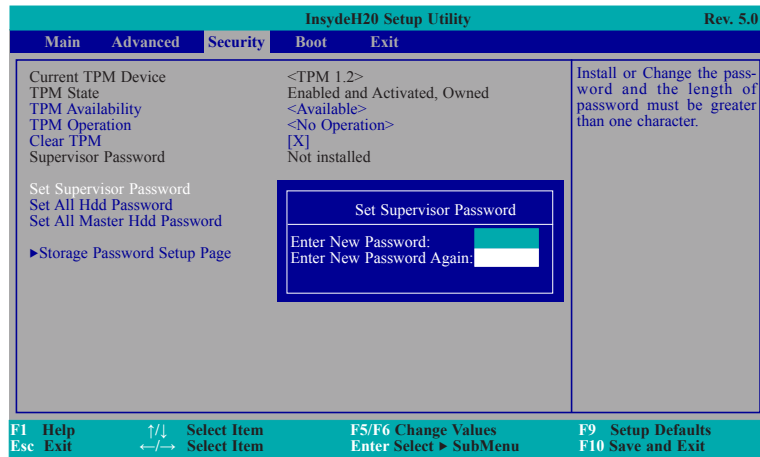

Set All Master HDD Password

Set a master password for all HDDs and the length of the password must be greater than one character.

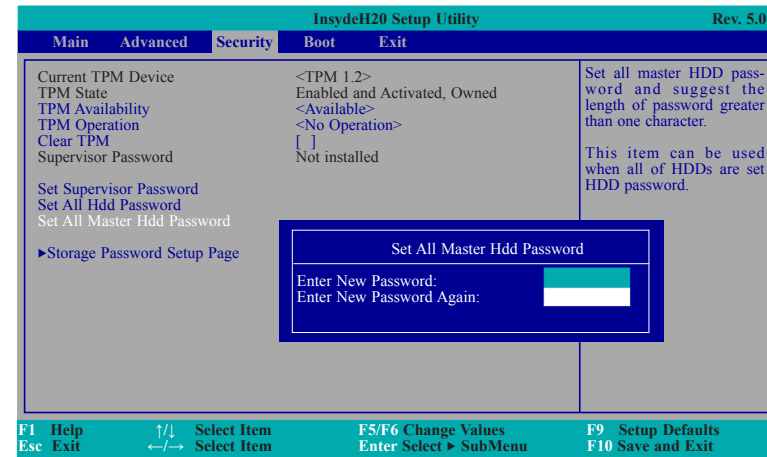

Set All HDD Password

Set a password for all HDDs and the length of the password must be greater than one character.

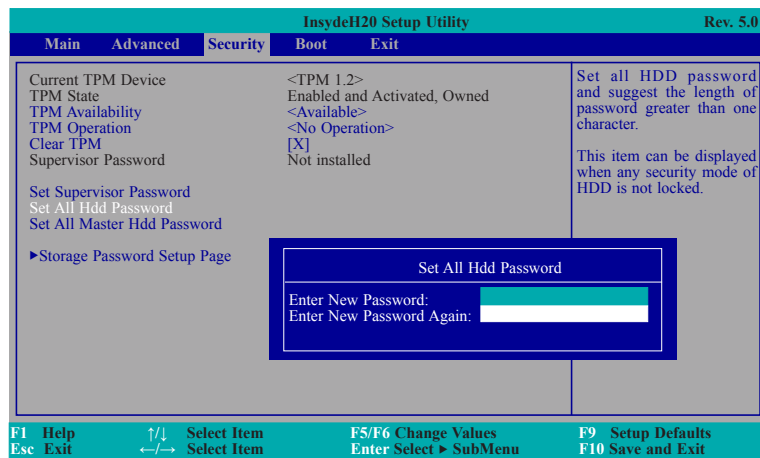

Storage Password Setup Page

Select an HDD and set a password for this hard disk drive.

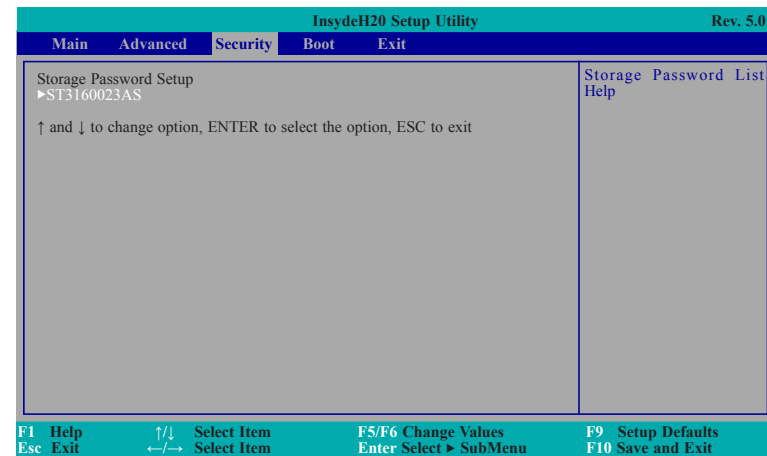

Device Name: Displays the name of the device.

Security Mode is described as follows:

Lock: The HDD security mode is enabled and this HDD is locked.

Unlock: The HDD security mode is enabled and this HDD is unlocked.

Change: The HDD security mode is unlock and the user can change its password.

Disable: Remove the HDD password from the device.

No Accessed: HDD security mode is not enabled.

Set Storage Password

Enter to set a password for this device and the length of password must be greater than one character.

Set Master Hdd Password

Enter to set a master HDD password. The length of password must be greater than one character. When the security mode is set to Lock, input the master HDD password to unlock the HDD.

To clear the HDD password, pressing "Enter" to set HDD security to be disabled.

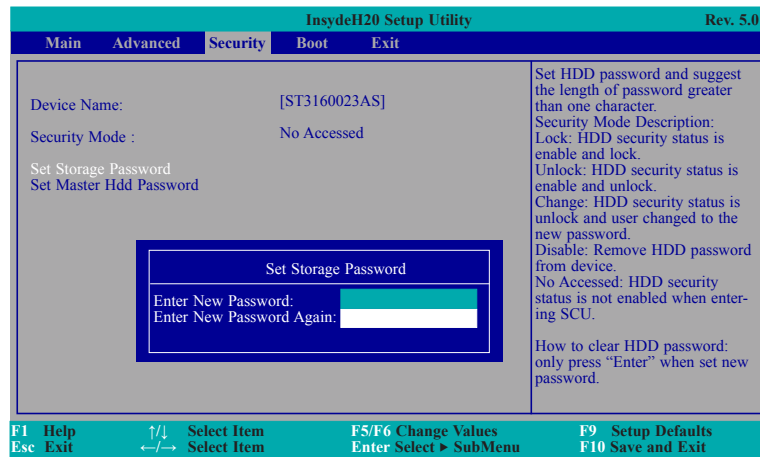

Boot

This section configures boot options.

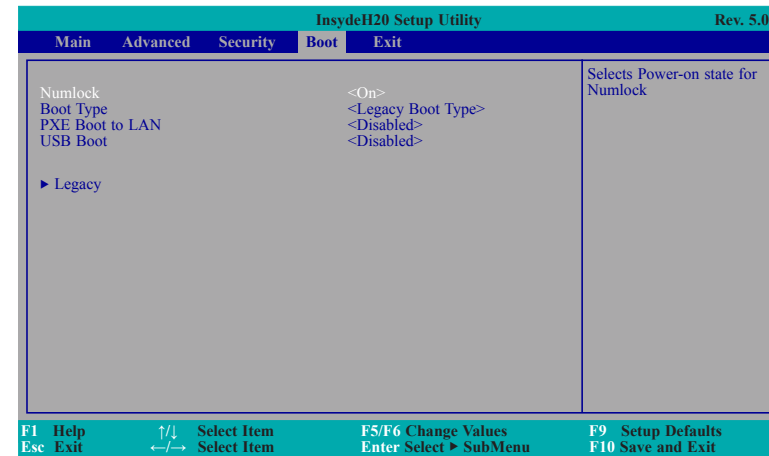

Numlock

Turn on or off the number lock key at boot.

Boot Type

Select the boot mode. The options are Dual Boot Type, Legacy Boot Type, and UEFI Boot Type.

PXE Boot to LAN

Disable or enable Preboot eXecution Environment (PXE) through LAN.

USB Boot

Enable or disable boot from USB devices.

Legacy

This section configures legacy boot order.

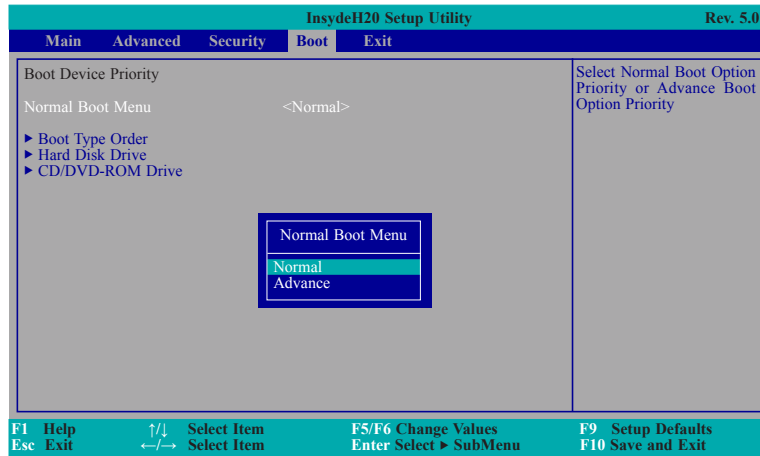

Normal Boot Menu

Normal

For this option, determine the boot order for the devices within each category. Use the + and - key to arrange the priority of the boot devices in the list. The first device in the list has the highest boot priority.

Advance

For this option, determine the boot order for all the detected devices. Use the + and - key to arrange the priority of the boot devices in the list. The first device in the list has the highest boot priority.

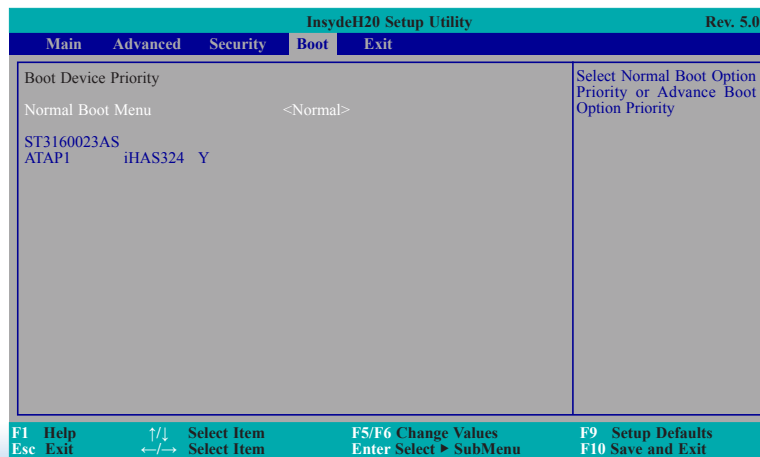

Boot Type Order

Use + and - keys to arrange the sequence of storage devices that the system's hardware checks for the operating system's boot files. The first device in the order list has the highest boot priority. For example, to boot from a floppy drive instead of a hard drive, place the floppy drive ahead of the hard drive in priority.

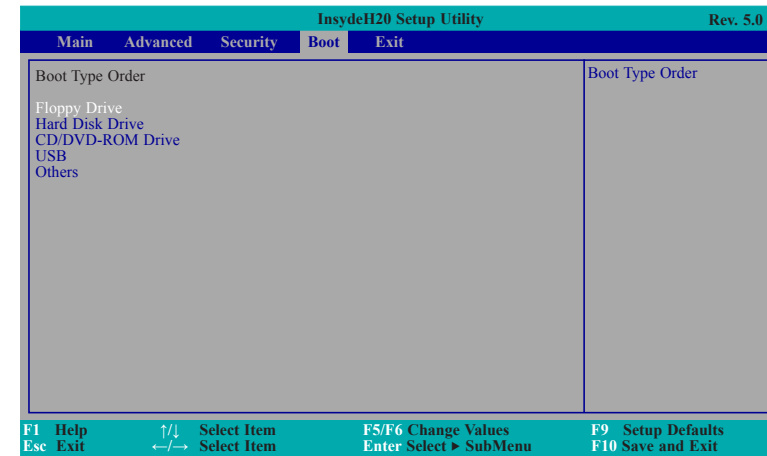

Hard Disk Drive

All installed hard disk drives will be displayed in this field. Use + and - keys to arrange the sequence of hard disk drives that the system's hardware checks for the operating system's boot files.

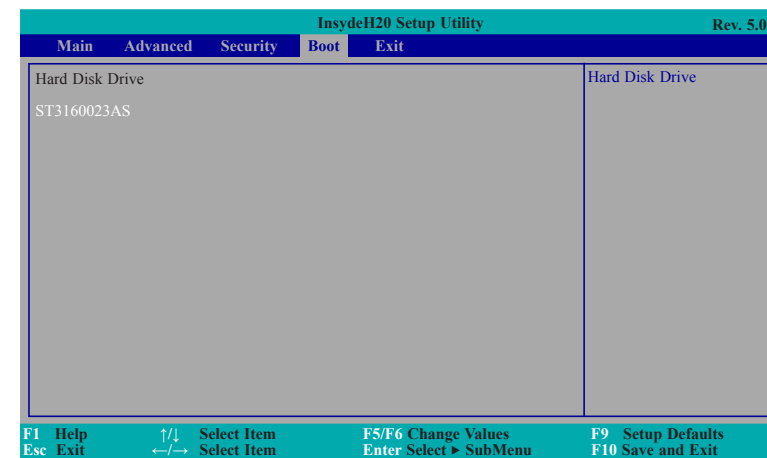

CD/DVD-ROM Drive

All installed CD/DVD-ROM drives will be displayed in this field. Use + and - keys to arrange the sequence of CD/DVD-ROM drives that the system's hardware checks for the operating system's boot files.

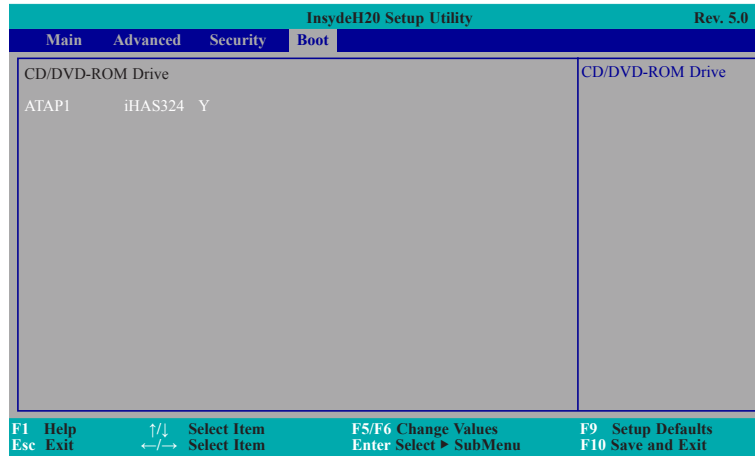

Exit

This section configures options for exiting the BIOS setup utility.

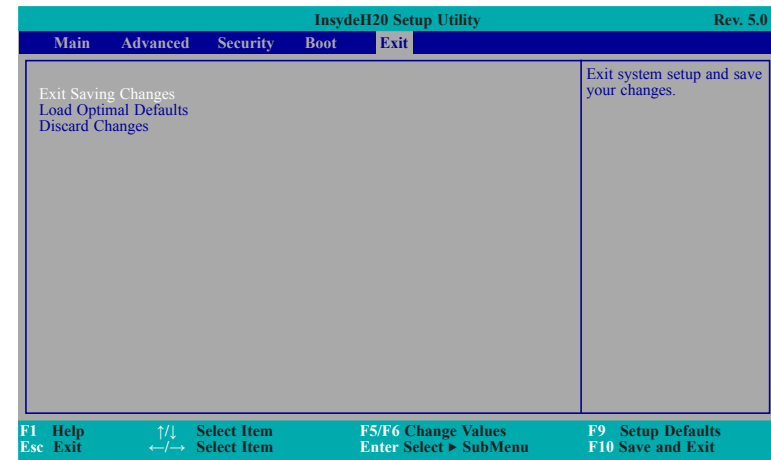

Exit Saving Changes

Select this field and then press <Enter> to exit the system setup and save your changes.

Load Optimal Defaults

Select this field and then press <Enter> to load optimal defaults.

Discard Changes

Select this field and then press <Enter> to exit the system setup without saving your changes.

Updating the BIOS

To update the BIOS, you will need the new BIOS file and a flash utility. Please contact technical support or your sales representative for the latest BIOS file and the firmware update utility. For instructions on how to update BIOS with the flash utility, please see <https://www.dfi.com/Knowledge/Video/31> from the Knowledge Base of the DFI website.

```

Read file successfully. (path= "platform.ini")

Information
Please do not remove the AC power

Insyde H20FFT (Flash Firmware Tool) Version (SEG) 100.00.08.10
Copyright(c) 2012 - 2016, Insyde Software Corp. All Rights Reserved.

Initializing
Current BIOS Model name: SH960
New BIOS Model name: SH960

Current BIOS version: 65.05A
New BIOS version: 65.05A

Updating Block at FFFFF000h
0%      25%      50%      75%      100%
C:\SH960>_

```

Notice: BIOS SPI ROM

1. The Intel® Management Engine has already been integrated into this system board. Due to the safety concerns, the BIOS (SPI ROM) chip cannot be removed from this system board and used on another system board of the same model.
2. The BIOS (SPI ROM) on this system board must be the original equipment from the factory and cannot be used to replace one which has been utilized on other system boards.
3. If you do not follow the methods above, the Intel® Management Engine will not be updated and will cease to be effective.

Note:



- a. You can take advantage of flash tools to update the default configuration of the BIOS (SPI ROM) to the latest version anytime.
- b. When the BIOS IC needs to be replaced, you have to populate it properly onto the system board after the EEPROM programmer has been burned and follow the technical person's instructions to confirm that the MAC address should be burned or not.

Chapter 5 - Supported Software

Install drivers, utilities and software applications that are required to facilitate and enhance the performance of the system board. You may acquire the software from your sales representatives, from an optional DVD included in the shipment, or from the website download page at <https://www.dfi.com/DownloadCenter>.

Auto Run Page (For Windows 10)

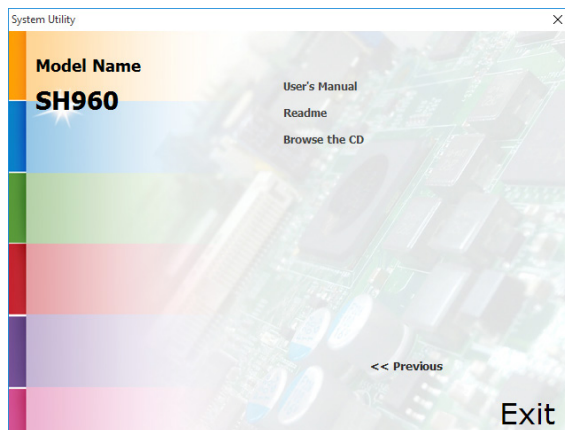
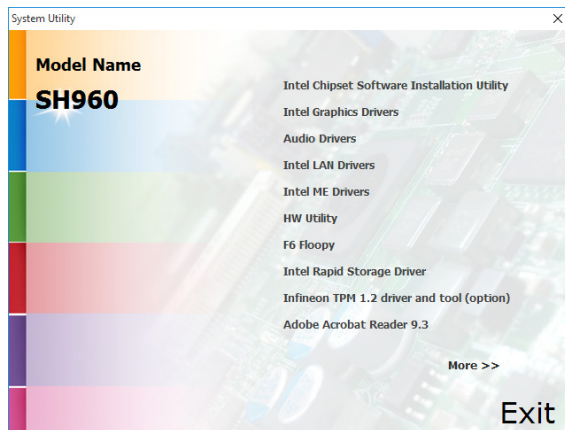

Auto Run Page (For Windows 8.1)

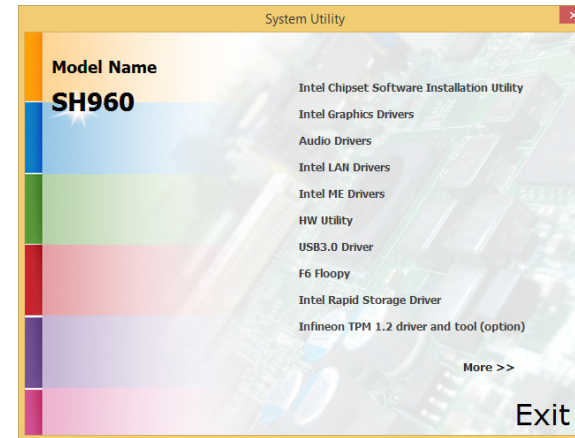

Auto Run Page (For Windows 7)

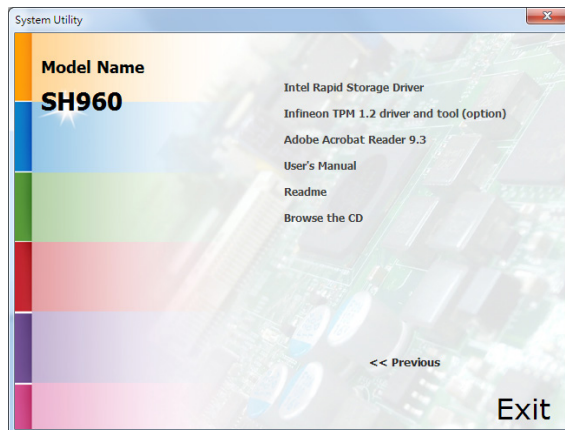
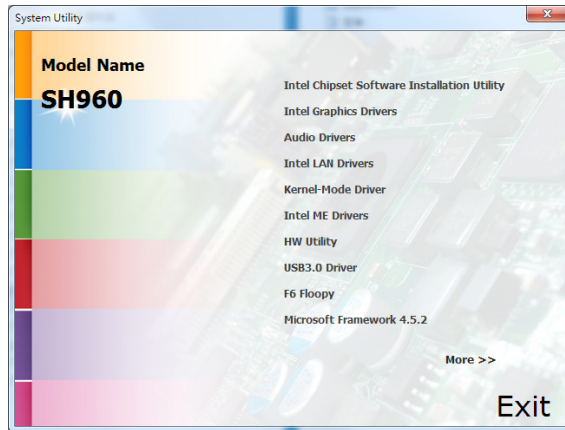

Note:

This step can be ignored if the applications are standalone files.

Intel Chipset Software Installation Utility

The Intel Chipset Software Installation Utility is used for updating Windows® INF files so that the Intel chipset can be recognized and configured properly in the system.

To install the utility, click "Intel Chipset Software Installation Utility" on the main menu.

1. Setup is ready to install the utility. Click "Next".



2. Read the license agreement then click "Yes".



- Go through the readme document for more installation tips then click "Next".



- After completing installation, click "Finish" to exit setup.



Intel Graphics Drivers

To install the driver, click "Intel Graphics Drivers" on the main menu.

- Setup is now ready to install the graphics driver. Click "Next".



By default, the "Automatically run WinSAT and enable the Windows Aero desktop theme" is enabled. With this enabled, after installing the graphics driver and the system rebooted, the screen will turn blank for 1 to 2 minutes (while WinSAT is running) before the Windows 7/ Windows 8.1/ Windows 10 desktop appears. The "blank screen" period is the time Windows is testing the graphics performance.

We recommend that you skip this process by disabling this function then click "Next".

- Read the license agreement then click "Yes".

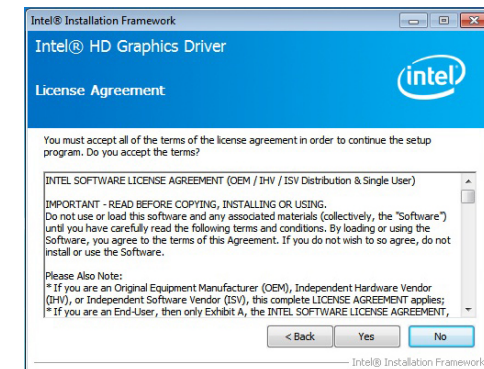

- Go through the readme document for system requirements and installation tips then click "Next".

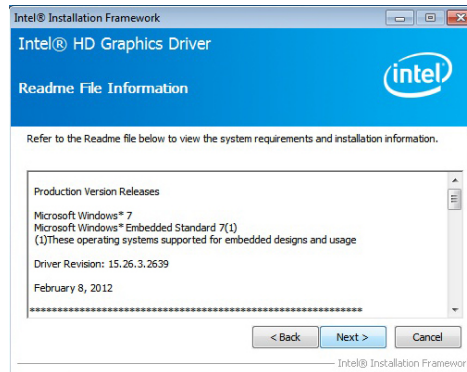

- Setup is now installing the driver. Click "Next" to continue.

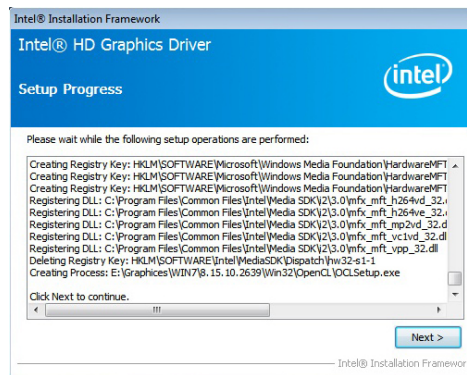

- Click "Yes, I want to restart this computer now" then click "Finish".

Restarting the system will allow the new software installation to take effect.



Audio Drivers (For COM332-B Carrier Board)

To install the driver, click "Audio Drivers (for COM332-B Carrier Board)" on the main menu.

- Setup is now ready to install the audio driver. Click "Next".
- Follow the remainder of the steps on the screen; clicking "Next" each time you finish a step.

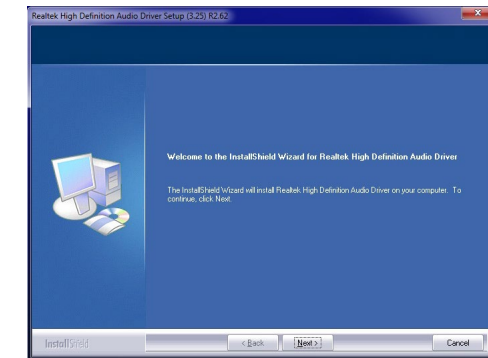

- Click "Yes, I want to restart my computer now" then click "Finish".

Restarting the system will allow the new software installation to take effect.

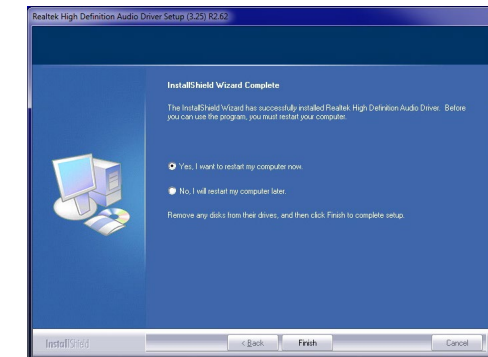

Intel LAN Drivers

To install the driver, click "Intel LAN Drivers" on the main menu.

1. Setup is ready to install the driver. Click "Next".



2. Click "I accept the terms in the license agreement" then click "Next".

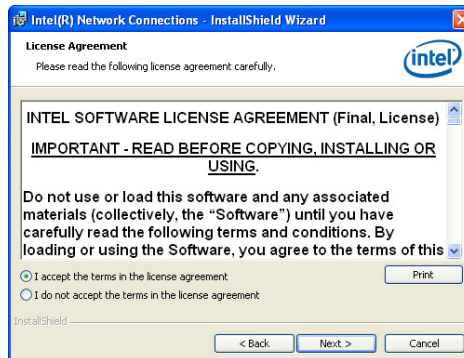

3. Select the program features you want installed then click "Next".

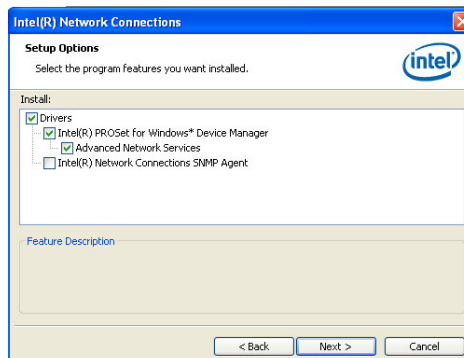

4. Click "Install" to begin the installation.

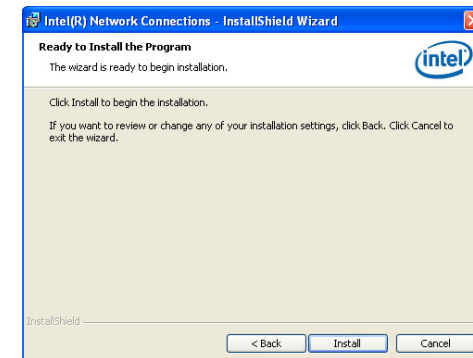

5. After completing installation, click "Finish".

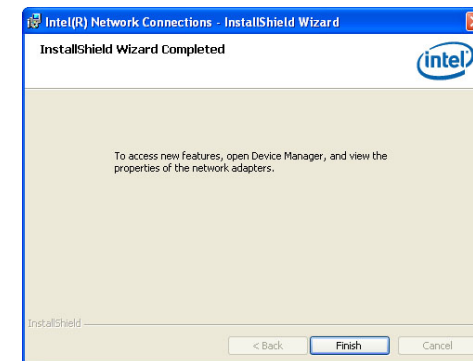

Kernel Mode Driver (For Windows 7 only)

To install the driver, click "Kernel Mode Driver Framework" on the main menu.

1. Click "Yes" to install the update.

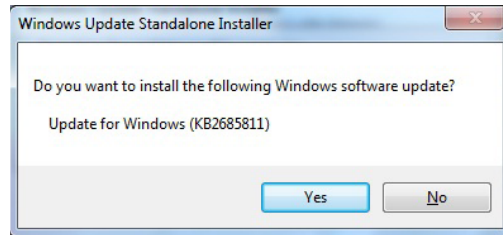

2. The update is installed now.

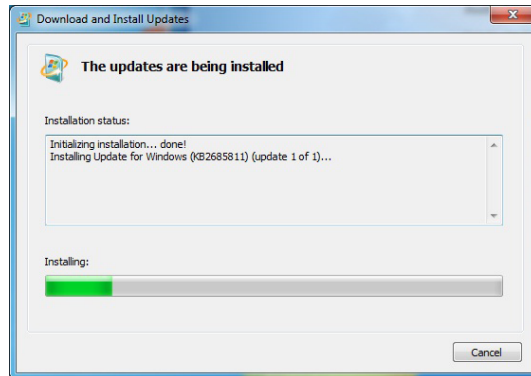

3. Click "Restart Now" to restart your computer when the installation is complete.

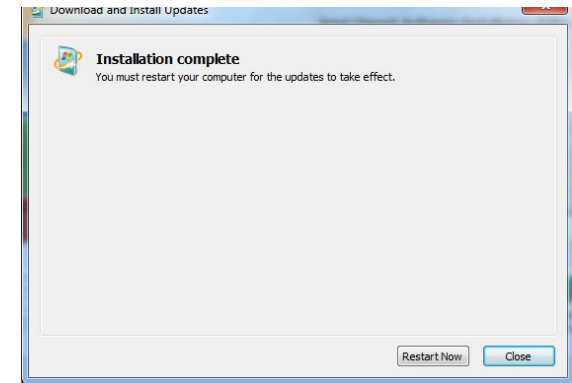

Intel Management Engine Drivers

To install the driver, click "Intel Management Engine Drivers" on the main menu.

1. Setup is ready to install the driver. Click "Next".

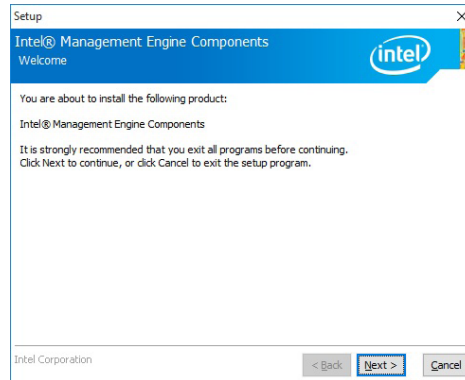

2. Read the license agreement then click "Next".

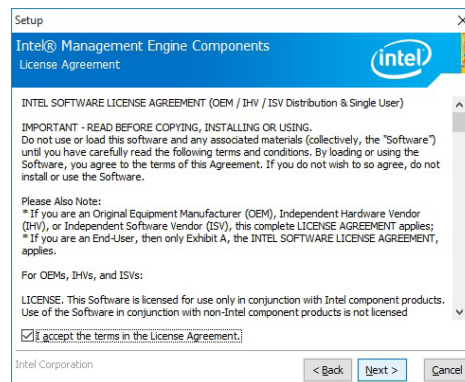

3. Setup is currently installing the driver. After installation has completed, click "Next".

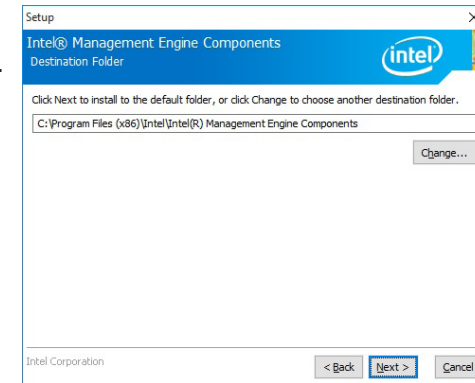

4. Please wait while the product is being installed.

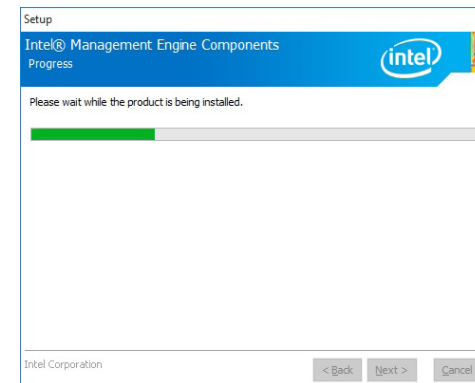

5. After completing installation, click "Finish".

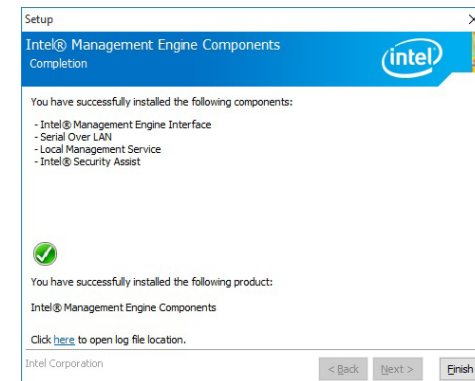

HW Utility

HW Utility provides information about the board, Watchdog, and DIO. To access the utility, click "HW Utility" on the main menu.



Note:

If you are using Windows 7, you need to access the operating system as an administrator to be able to install the utility.

1. Setup is ready to install the driver.

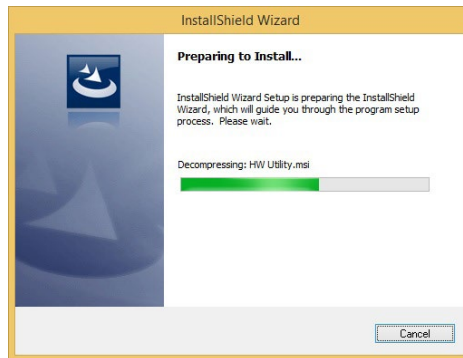

2. Click "Next" to continue.



3. Read the license agreement then click "I accept the terms in the license agreement". Click "Next".

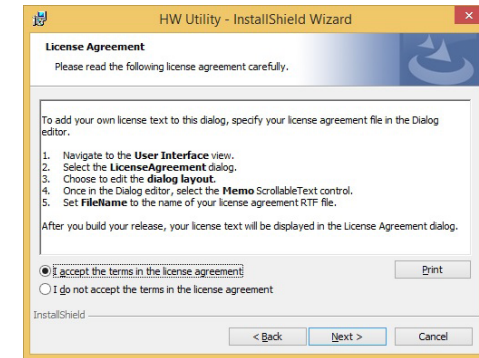

4. The wizard is ready to begin installation. Click "Install".

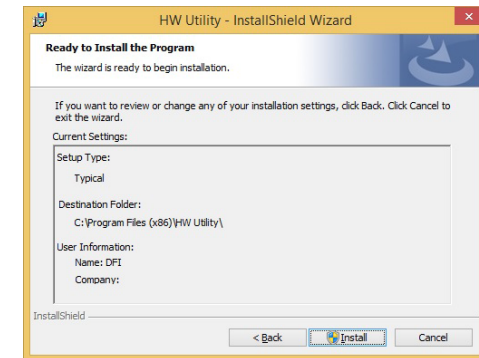

5. Please wait while the program features are being installed.

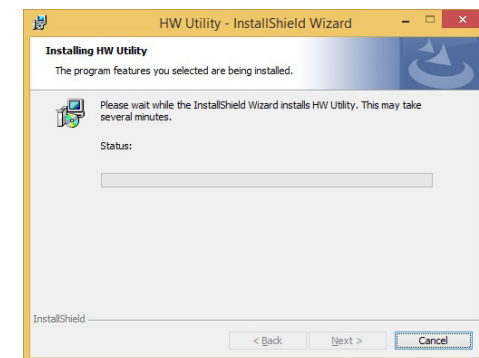

6. After completing installation, click "Finish".



The HW Utility icon will appear on the desktop. Double-click the icon to open the utility.



Information



HW Health

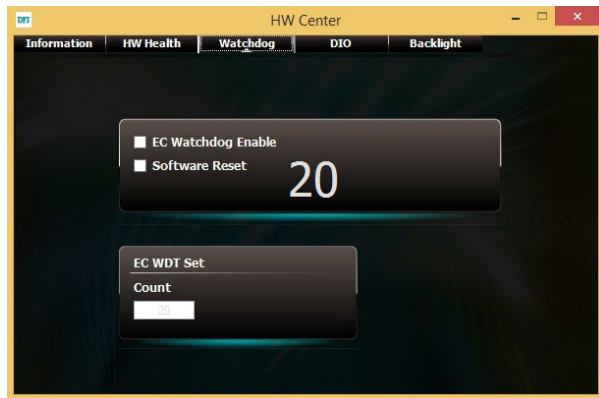

Watchdog

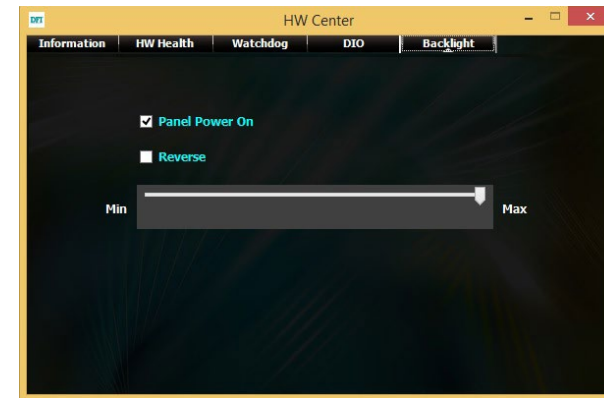

Backlight



DIO

Intel USB 3.0 Drivers (For Windows 7 and Windows 8.1)

To install the driver, click "Intel USB 3.0 Driver" on the main menu.

1. Setup is ready to install the driver. Click "Next".

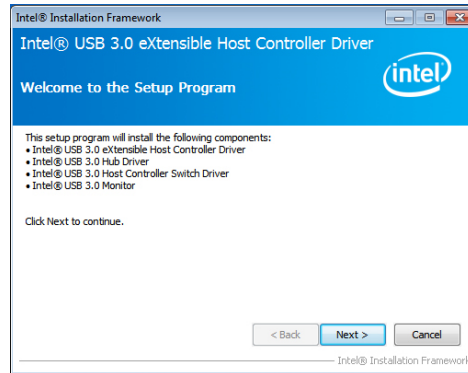

2. Read the license agreement then click "Yes".

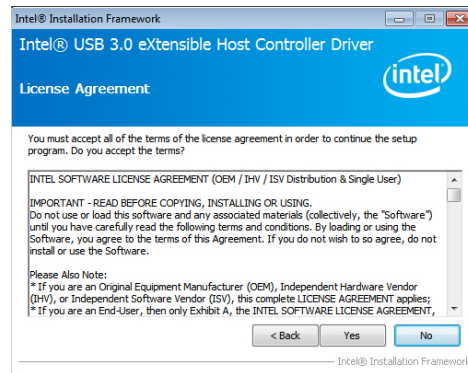

3. Go through the readme document for more installation tips then click "Next".

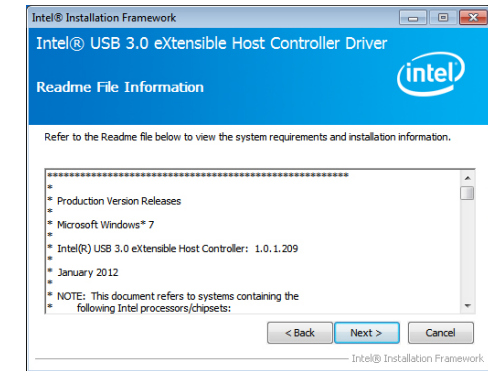

4. Setup is currently installing the driver. After installation has completed, click "Next".

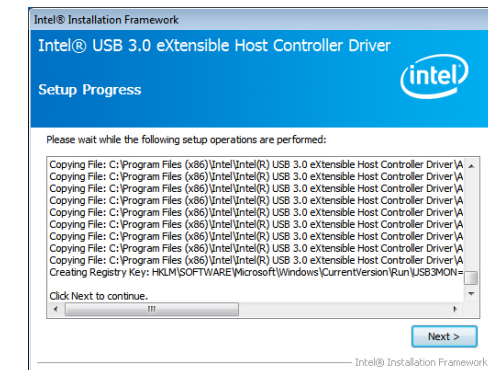

5. After completing installation, click "Finish".

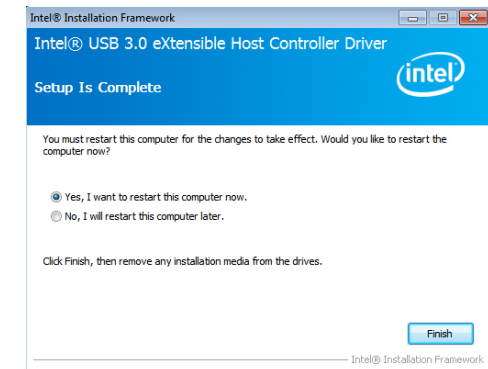

Microsoft Framework 4.5.2 (For Windows 7)

Note:

Before installing Microsoft Framework 4.5.2, make sure you have updated your Windows 7 operating system to Service Pack 1.

To install the driver, click "Microsoft Framework 4.5.2" on the main menu.

1. Setup is now extracting files.

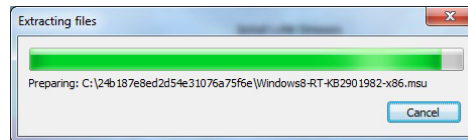

2. Read the license agreement carefully.

Click "I have read and accept the terms of the License Agreement" then click "Install".

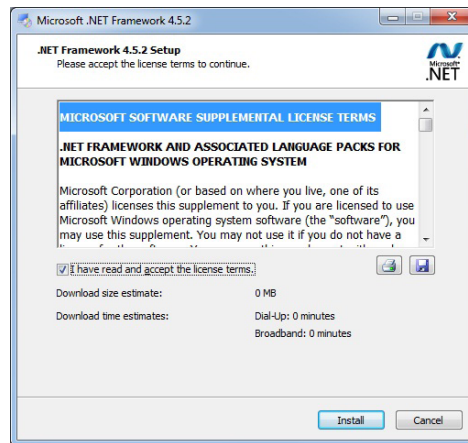

3. Setup is now installing the driver.

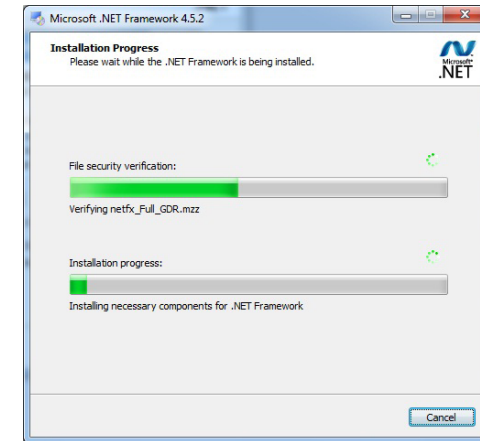

4. Click "Finish".

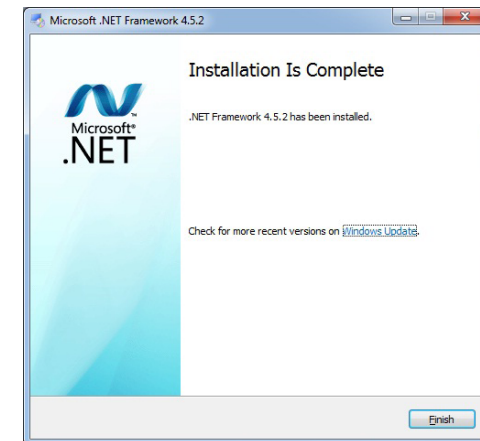

Intel Rapid Storage Technology

The Intel Rapid Storage Technology is a utility that allows you to monitor the current status of the SATA drives. It enables enhanced performance and power management for the storage subsystem.

To install the driver, click "Intel Rapid Storage Technology" on the main menu. Please refer to **Chapter 6** for more information.

Infinion TPM 1.2 Driver and Tool (Optional)

To install the driver, click "Infinion TPM driver and tool (option)" on the main menu.

1. The setup program is preparing to install the driver.

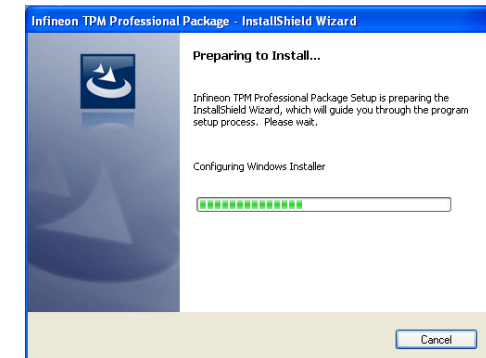

2. The setup program is now ready to install the utility. Click "Next".

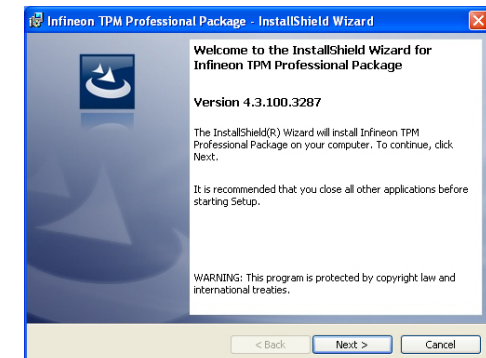

3. Click "I accept the terms in the license agreement" and then click "Next".

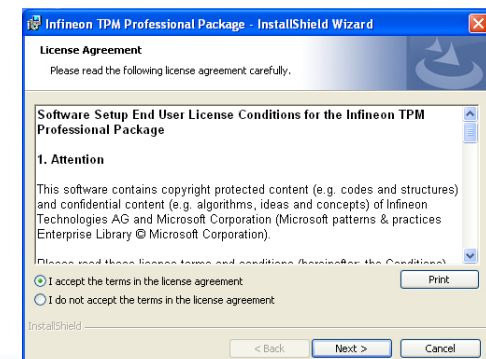

4. Enter the necessary information and then click "Next".

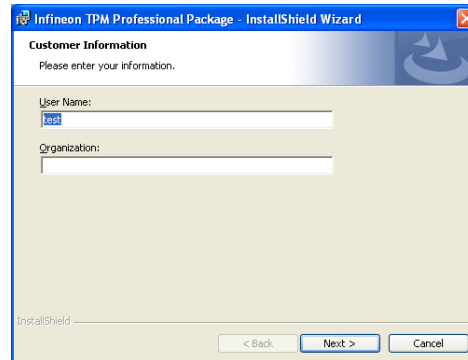

5. Select a setup type and then click "Next".

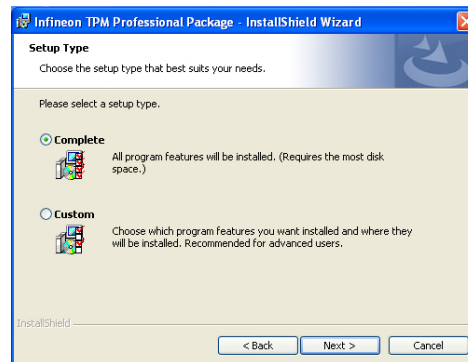

6. Click "Install".

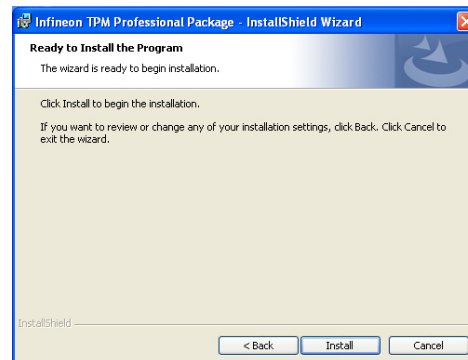

7. TPM requires installing the Microsoft Visual C++ package prior to installing the utility. Click "Install".

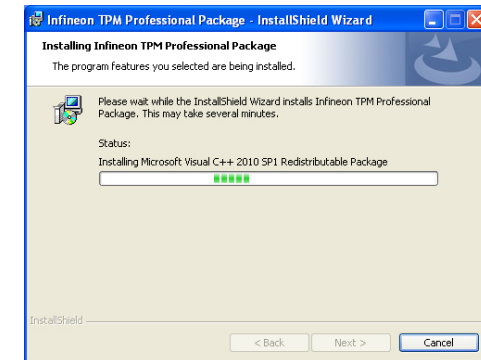

8. The setup program is currently installing the Microsoft Visual C++ package.

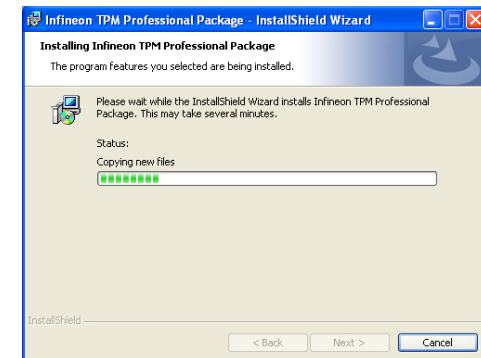

9. Click "Finish".

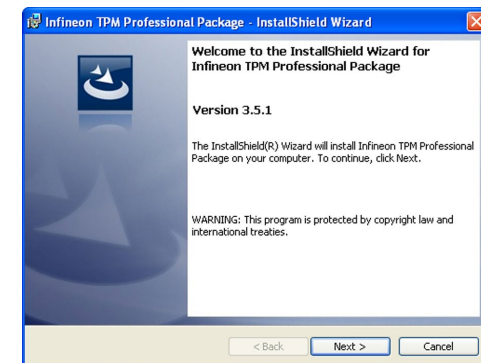

10. Click "Yes" to restart your system.

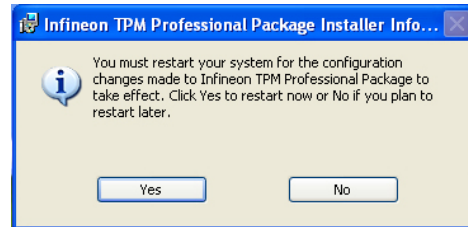

Adobe Acrobat Reader 9.3

To install the reader, click "Adobe Acrobat Reader 9.3" on the main menu.

1. Click Next to install or click Change Destination Folder to select another folder.

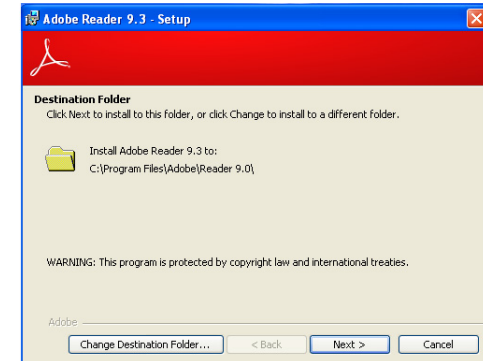

2. Click "Install" to begin installation.

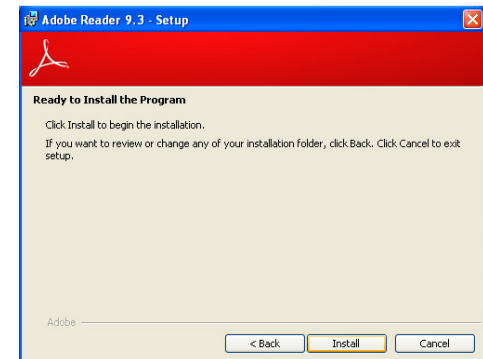

3. Click "Finish" to exit installation.

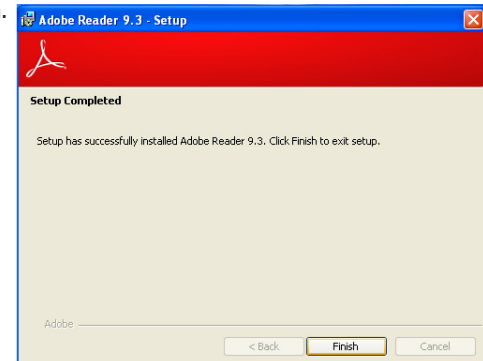

Chapter 6 - RAID

The system board allows the configuration of RAID on Serial ATA drives. It supports RAID 0, RAID 1, RAID 5 and RAID 10.

RAID Levels

RAID 0 (Striped Disk Array without Fault Tolerance)

RAID 0 uses two new identical hard disk drives to read and write data in parallel, interleaved stacks. Data is divided into stripes and each stripe is written alternately between two disk drives. This improves the I/O performance of the drives at different channel; however it is not fault tolerant. A failed disk will result in data loss in the disk array.

RAID 1 (Mirrored Disk Array with Fault Tolerance)

RAID 1 copies and maintains an identical image of the data from one drive to the other drive. If a drive fails to function, the disk array management software directs all applications to the other drive since it contains a complete copy of the drive's data. This enhances data protection and increases fault tolerance to the entire system. Use two new drives or an existing drive and a new drive but the size of the new drive must be the same or larger than the existing drive.

RAID 5 (Striped Disk Array with Distributed Parity)

RAID 5 stripes data and parity information across hard drives. It is fault tolerant and provides better hard drive performance and higher disk utilization than RAID 1.

RAID 10 (Mirrored and Striped Disk Array)

RAID 10 is a combination of data striping and data mirroring providing the benefits of both RAID 0 and RAID 1.

RAID Level	Min. Drives	Protection	Description
RAID 0	2	None	Data striping without redundancy
RAID 1	2	Single Drive Failure	Disk mirroring
RAID 5	3	Single Drive Failure	Block-level data striping with distributed parity
RAID 10	4	1 Disk Per Mirrored Stripe (not same mirror)	Combination of RAID 0 (data striping) and RAID 1 (mirroring)

Settings

To enable the RAID function, the following settings are required.

1. Connect the Serial ATA drives.
2. Enable Serial ATA in the Insyde BIOS.
3. Create a RAID volume.
4. Install the Intel Rapid Storage Technology Utility.

Step 1: Connect the Serial ATA Drives

Refer to Chapter 2 for details on connecting the Serial ATA drives.



Important:

1. Make sure you have installed the Serial ATA drives and connected the data cables otherwise you won't be able to enter the RAID BIOS utility.
2. Treat the cables with extreme caution especially while creating RAID. A damaged cable will ruin the entire installation process and operating system. The system will not boot and you will lost all data in the hard drives. Please give special attention to this warning because there is no way of recovering back the data.

Step 2: Enable RAID in the Insyde BIOS

1. Power-on the system then press to enter the main menu of the Insyde BIOS.
2. Go to "Advanced" menu, and select the "SATA Configuration" menu.
3. Change the "SATA Mode Selection" to "RAID" mode.
4. Save the changes in the "Save & Exit" menu.
5. Reboot the system.

Step 3: Create a RAID Volume

1. When the Intel® RST option ROM status screen displays during POST, press <Ctrl> and <I> simultaneously to enter the option ROM user interface.
2. Select 1: Create RAID Volume and press <Enter>.
3. Use the up or down arrow keys to select the RAID level and press <Enter>.
4. Use the up or down arrow keys to select the strip size and press <Enter>.
5. Press <Enter> to select the physical disks.
6. Use the up or down arrow keys to scroll through the list of hard drives and press <Space> to select the drive.
7. Press <Enter>.
8. Select the volume size and press <Enter>. You must select less than one hundred percent of the available volume space to leave space for the second volume.
9. Press <Enter> to create the volume.
10. At the prompt, press <Y> to confirm volume creation.
11. Select 4: Exit and press <Enter>.
12. Press <Y> to confirm exit.



Note:

These steps are cited from the Intel® Support site, "Set Up a System with Intel® Matrix RAID Technology" (Article ID: 000005789).

Step 3-1: Create a RAID Volume if the Boot Type is UEFI

If the boot type is set to UEFI, RAID volume creation will be different. Please use the following steps to create RAID volumes. To set the boot type, enter the Insyde BIOS and go to "Boot" > "Boot type".

1. Go to the "Advanced" menu of the Insyde BIOS.
2. The "Intel® Rapid Storage Technology" menu appears. Enter this menu.

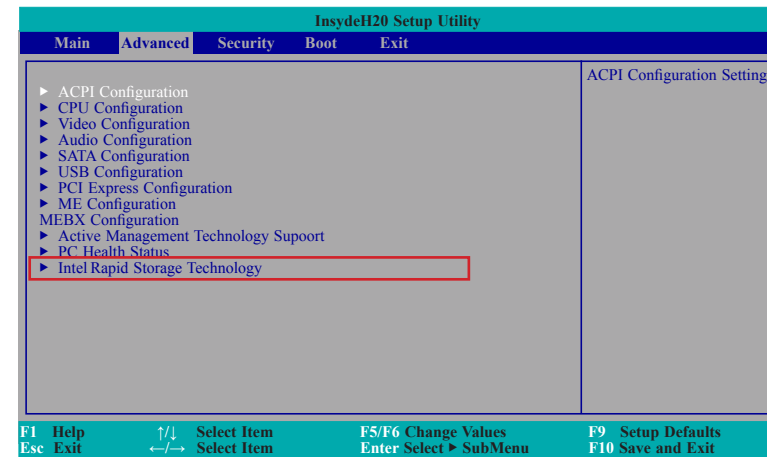

- The screen displays all available drives. Select "Create RAID volume" to create a RAID volume".
- Use the up or down arrow keys to select the RAID level and press <Enter>.
- Use the up or down arrow keys to scroll through the list of hard drives and press <Enter> and select "x" to select the drive for the RAID group.
- Use the up or down arrow keys to select the strip size and press <Enter>.
- Enter the capacity for the volume and press <Enter>.
- Select "Create Volume" to start creating the volume.



Step 4: Install the Intel Rapid Storage Technology Utility

The Intel Rapid Storage Technology Utility can be installed from within Windows. It allows RAID volume management (create, delete, migrate) from within the operating system. It will also display useful SATA device and RAID volume information. The user interface, tray icon service and monitor service allow you to monitor the current status of the RAID volume and/or SATA drives. It enables enhanced performance and power management for the storage subsystem.

- Insert the provided DVD into an optical drive.
- Click "Intel Rapid Storage Technology Utility" on the main menu.
- Setup is ready to install the utility. Click "Next".

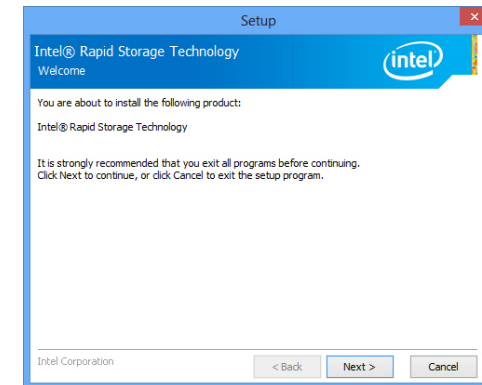

- Read the license agreement and click "I accept the terms in the License Agreement." Then, click "Next".

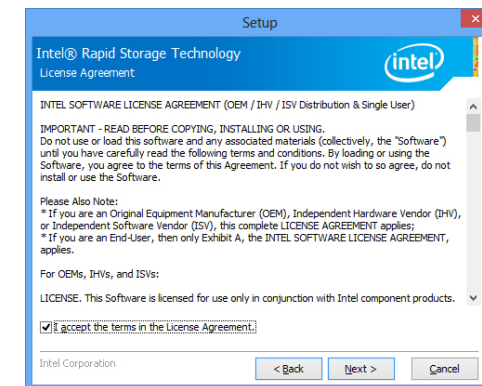

5. Go through the readme document to view system requirements and installation information then click "Next".

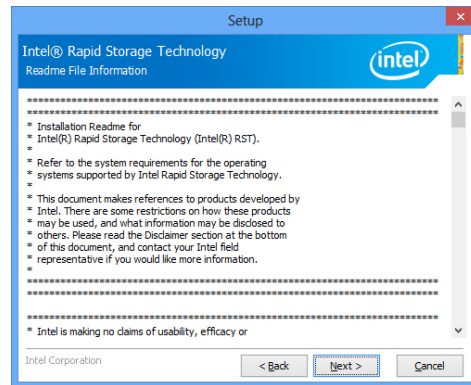

6. Click "Next" to install to the default folder or click change to choose another destination folder.

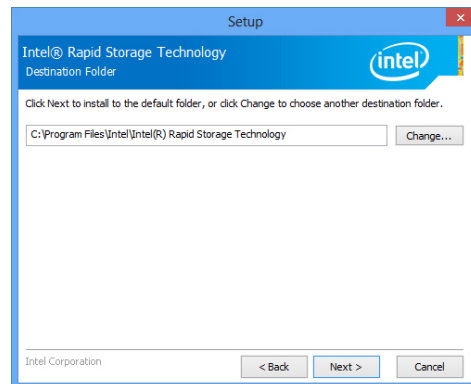

7. Confirm the installation and click "Next".

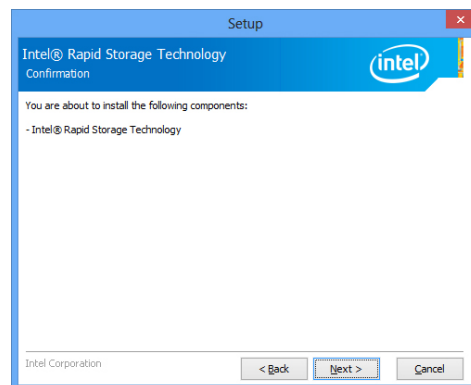

8. Click "Yes, I want to restart this computer now" to complete the installation and then click "Finish".

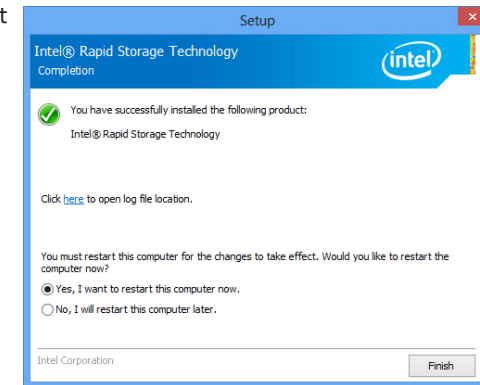

Enable Intel Smart Response Technology

Intel® Rapid Storage Technology (Intel® RST) comes with a caching feature, Intel® Smart Response Technology, to improve system performance with an SSD used as cache memory.

To use this features, the following requirements have to be met:

- *Intel RST software 10.5 version release or later
- *Single hard disk drive or multiple drives in one RAID volume
- *Solid state drive (SSD) with a minimum capacity of 18.6 GB
- *Operating system: Windows 7 (32-bit and 64-bit editions) or later versions

Before using this function, setup your system with the following methods:

1. Configure SATA mode in BIOS setup. Please refer to the previous section on Intel Rapid Storage Technology for detailed instructions.
2. Install the operating system and all required device drivers.
3. Install the Intel RST software version 10.5 or later.
4. Enable Intel Smart Response Technology, which is denoted as accelerate in the Intel RST software.



Note:

The above information is cited from the Intel® Support site, "Intel® Smart Response Technology User Guide" (Article ID: 000005501).

Chapter 7 - Intel AMT Settings

Overview

Intel Active Management Technology (Intel® AMT) combines hardware and software solution to provide maximum system defense and protection to networked systems.

The hardware and software information are stored in non-volatile memory. With its built-in manageability and latest security applications, Intel® AMT provides the following functions.

- **Discover**

Allows remote access and management of networked systems even while PCs are powered off; significantly reducing desk-side visits.

- **Repair**

Remotely repair systems after OS failures. Alerting and event logging help detect problems quickly to reduce downtime.

- **Protect**

Intel AMT's System Defense capability remotely updates all systems with the latest security software. It protects the network from threats at the source by proactively blocking incoming threats, reactively containing infected clients before they impact the network, and proactively alerting when critical software agents are removed.

Enable Intel® AMT in the Insyde BIOS

1. Power-on the system then press to enter the main menu of the Insyde BIOS.
2. In the **Advanced** menu, select **AMT Configuration**.

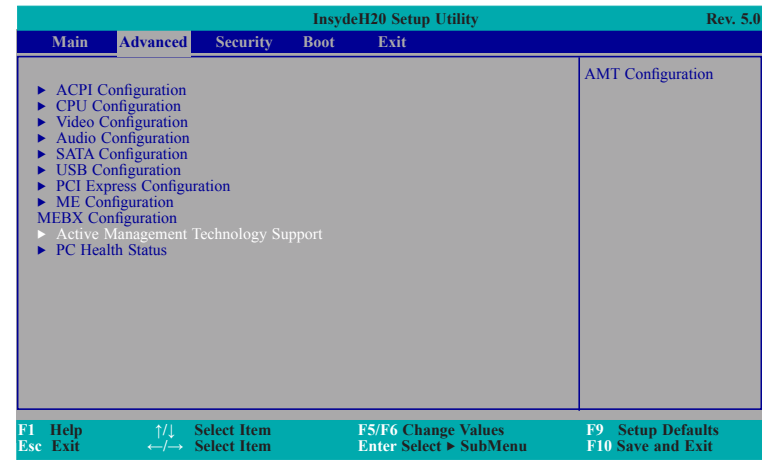

3. In the **Advanced** menu, select **Enable** in the **AMT** field.

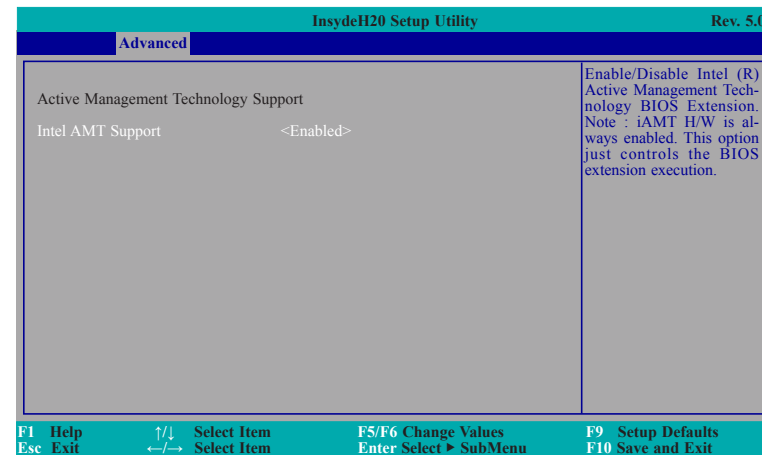

4. In the **Exit** menu, select **Save Changes and Reset** then select **OK**.

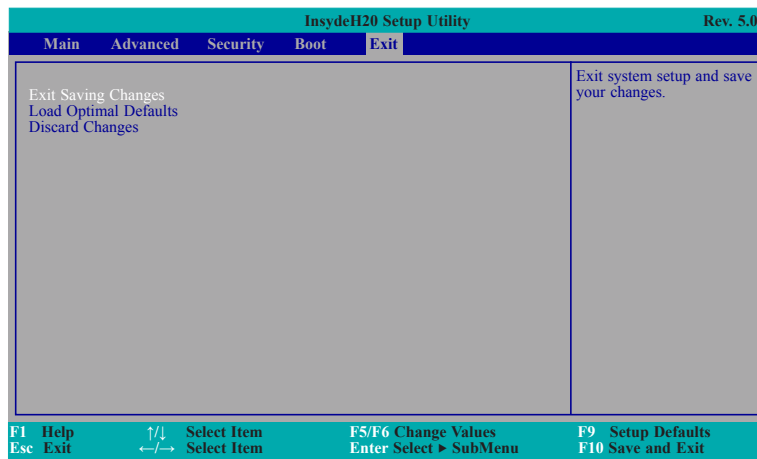

Set up Intel® AMT using the Intel® Management Engine BIOS Extension (MEBX)

1. When the system reboots, you will be prompted for a password. The default password is "**admin**". Enter the default password in the space provided under Intel(R) ME Password then press Enter.

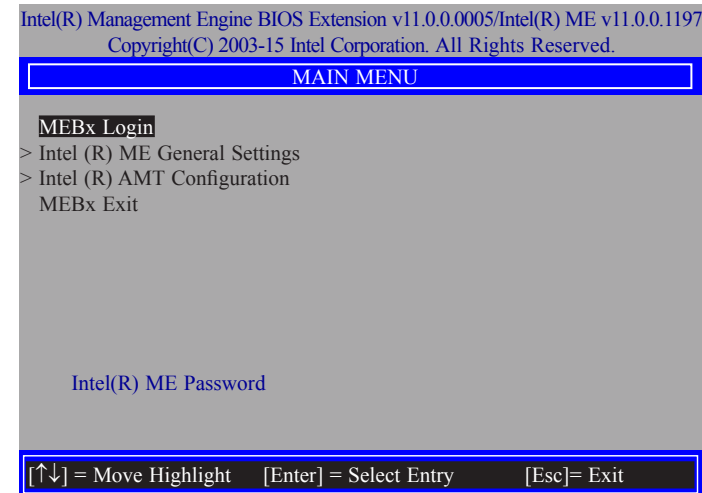

2. Enter a new password in the space provided under Intel(R) ME New Password then press Enter. The password must include:
- 8-32 characters
 - Strong 7-bit ASCII characters excluding : , and " characters
 - At least one digit character (0, 1, ...9)
 - At least one 7-bit ASCII non alpha-numeric character, above 0x20, (e.g. !, \$, ;)
 - Both lower case and upper case characters

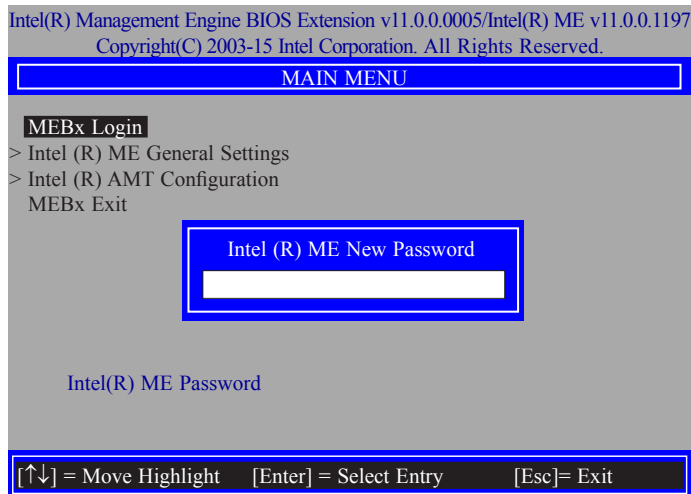

3. You will be asked to verify the password. Enter the same new password in the space provided under Verify Password then press Enter.

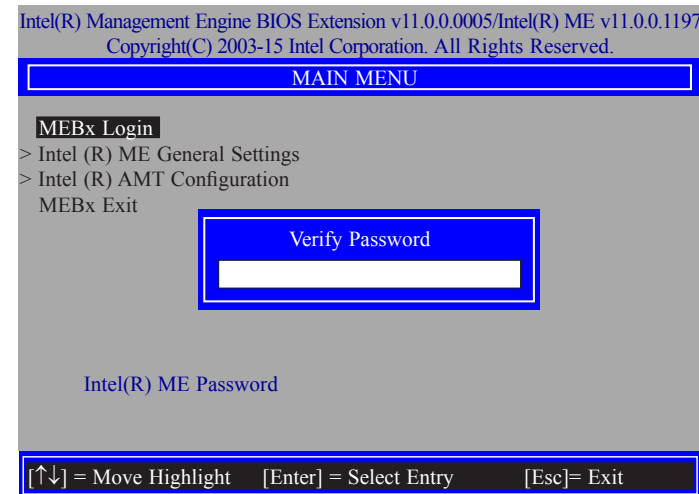

4. Select **Intel(R) ME General Settings** then press Enter.

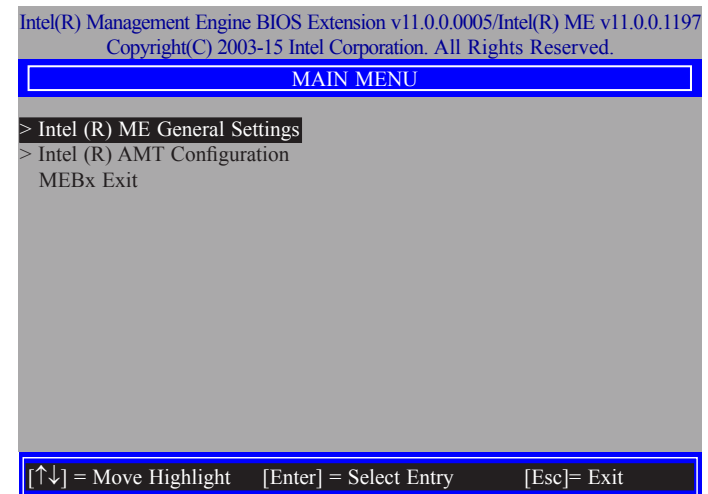

5. Select **Change Intel(R) ME Password** then press Enter.

You will be prompted for a password. The default password is "admin". Enter the default password in the space provided under Intel(R) ME New Password then press Enter.

- 8-32 characters
- Strong 7-bit ASCII characters excluding : , and " characters
- At least one digit character (0, 1, ...9)
- At least one 7-bit ASCII non alpha-numeric character, above 0x20, (e.g. !, \$, ;)
- Both lower case and upper case characters

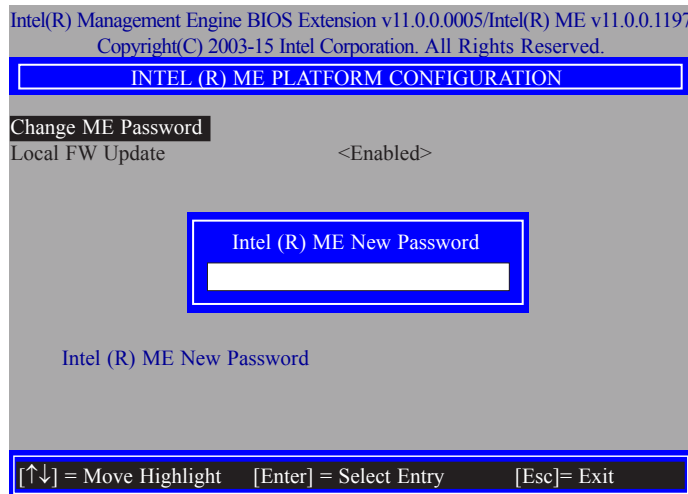

6. Select **Local FW Update** then press Enter. Select **Enabled** then press Enter.

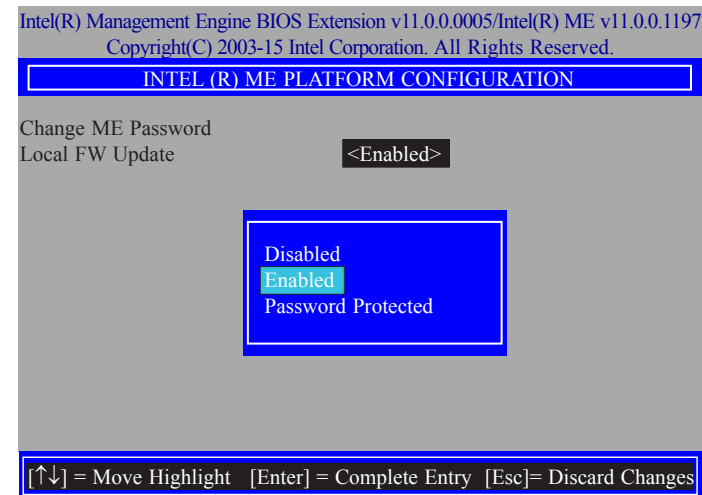

7. Select Previous Menu until you return to the **Main Menu**. Select **Intel(R) AMT Configuration** then press Enter.

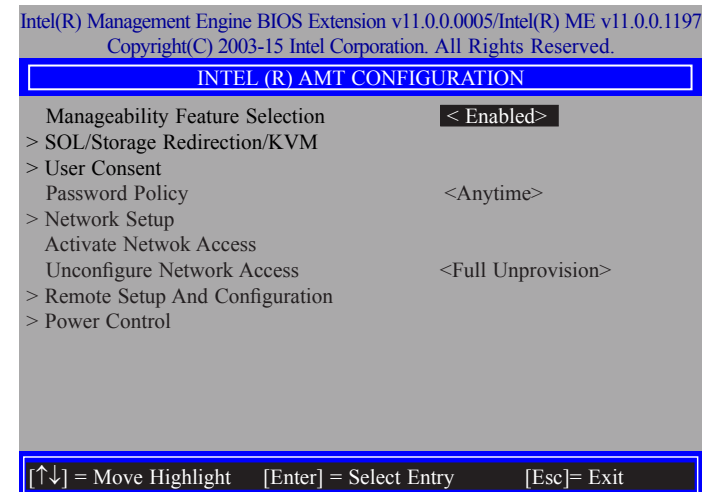

8. In the **Intel(R) AMT Configuration** menu, select **Manageability Feature Selection** then press Enter. Select **Enabled** or **Disabled** then press Enter.

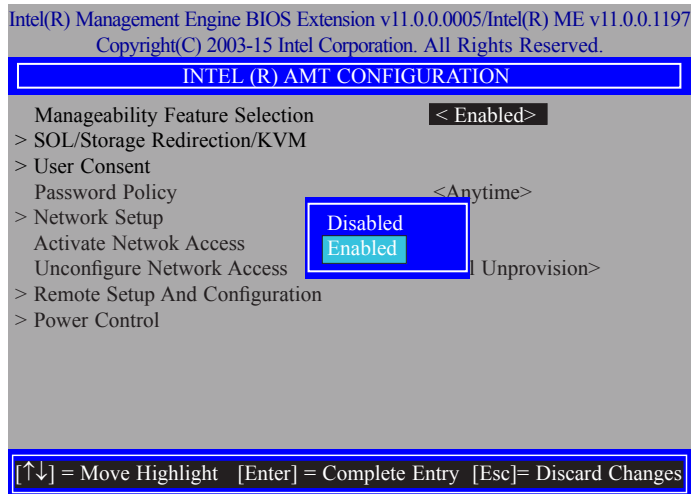

10. In the **SOL/Storage Redirection/KVM** menu, select **Username and Password** then press Enter. Select **Enabled** or **Disabled** then press Enter.

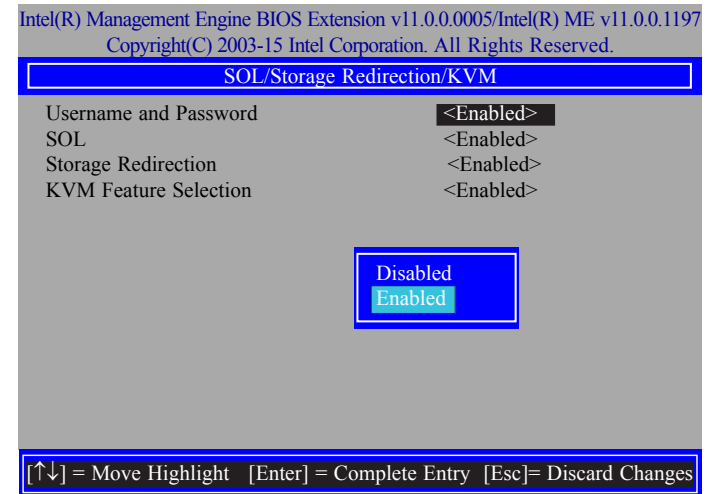

9. In the **Intel(R) AMT Configuration** menu, select **SOL/Storage Redirection/KVM** then press Enter.

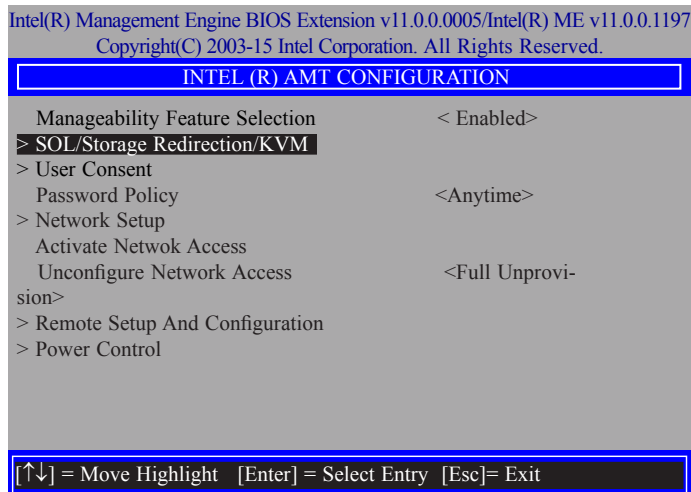

11. In the **SOL/Storage Redirection/KVM** menu, select **SOL** then press Enter. Select **Enabled** or **Disabled** then press Enter.

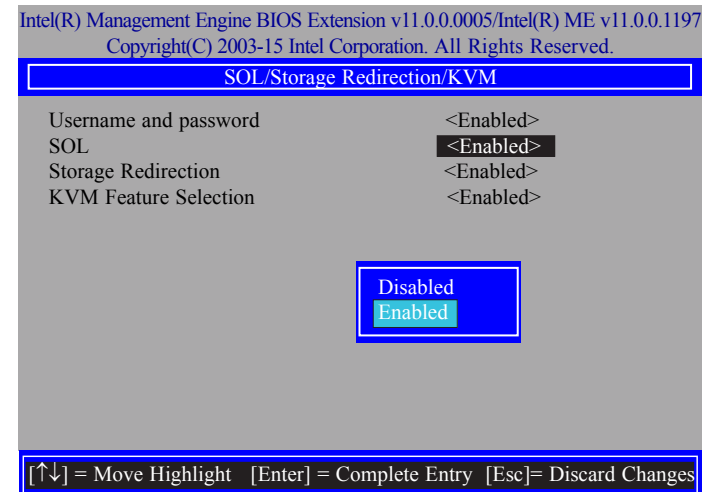

12. In the **SOL/Storage Redirection/KVM** menu, select **Storage Redirection** then press Enter. Select **Enabled** or **Disabled** then press Enter.

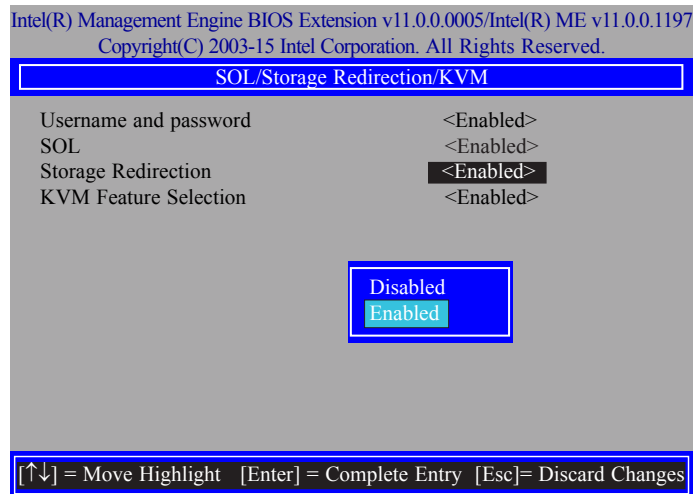

14. Select Previous Menu until you return to the **Intel(R) AMT Configuration** menu. Select **User Consent** then press Enter.

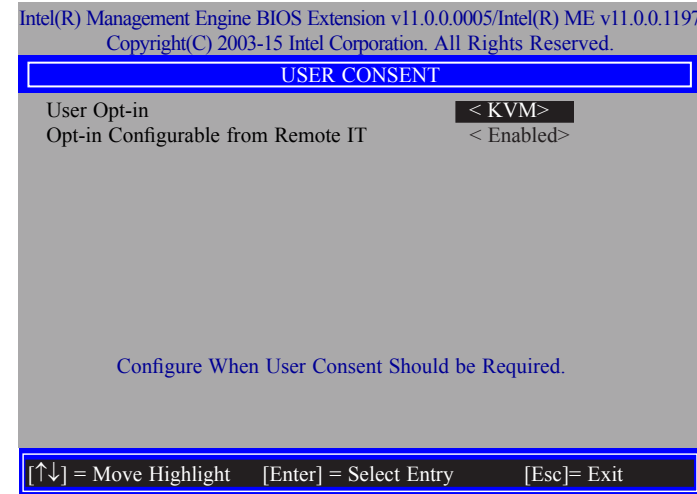

13. In the **SOL/Storage Redirection/KVM** menu, select **KVM Feature Selection** then press Enter. Select **Enabled** or **Disabled** then press Enter.

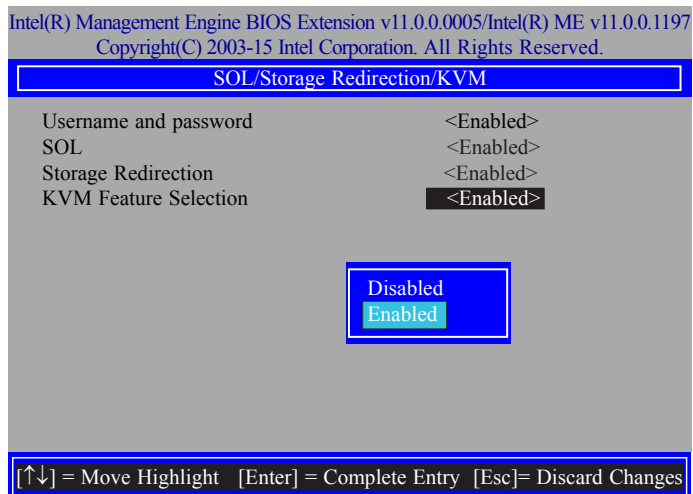

15. In the **User Consent** menu, select **User Opt-in** then press Enter. Select **None** or **KVM** or **ALL** then press Enter.

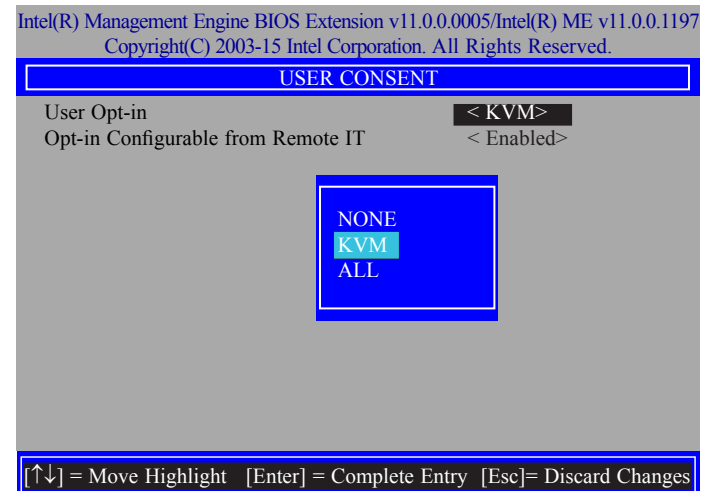

16. In the **User Consent** menu, select **Opt-in Configurable from Remote IT** then press Enter. Select **Enabled** or **Disable Remote Control of KVM Opt-in Policy** then press Enter.

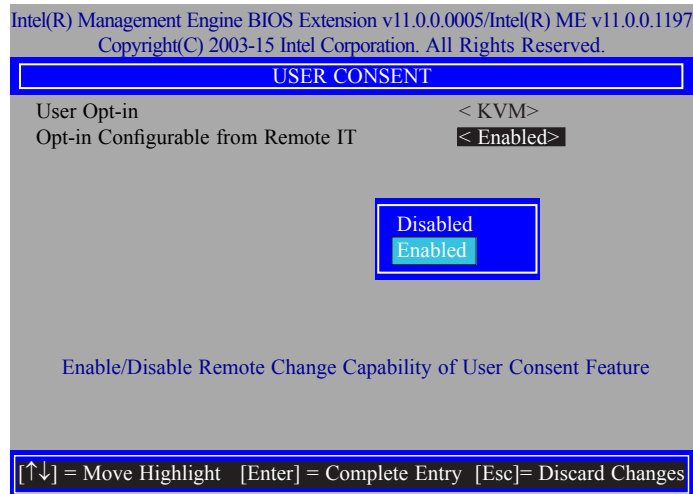

17. Select Previous Menu until you return to the **Intel(R) AMT Configuration** menu. Select **Password Policy** then press Enter.

You may choose to use a password only during setup and configuration or to use a password anytime the system is being accessed.

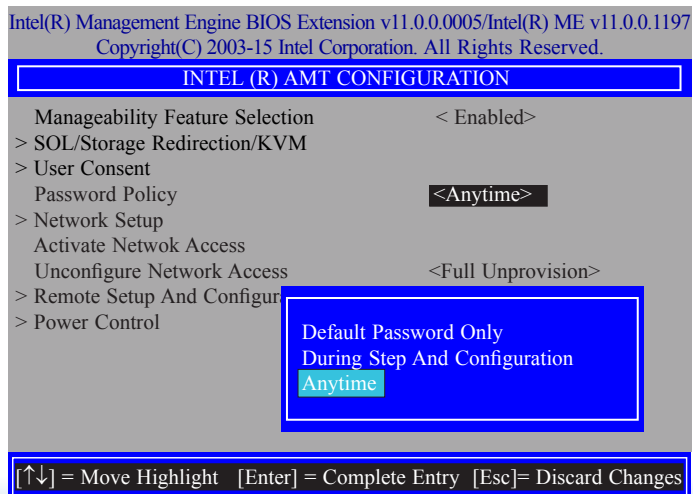

18. In the **Intel(R) AMT Configuration** menu, select **Network Setup** then press Enter.

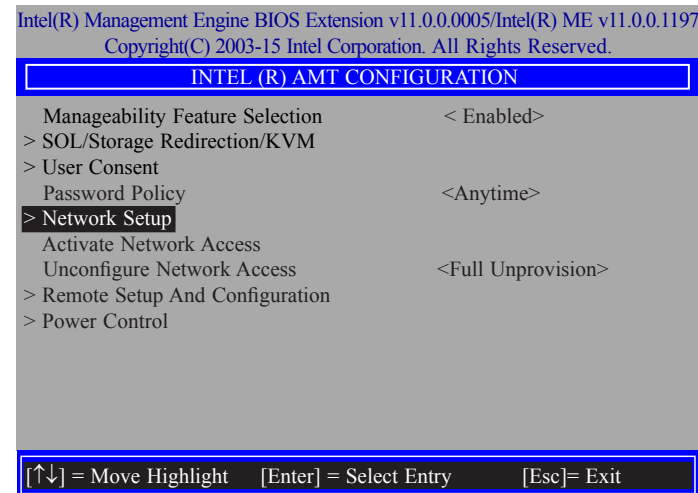

19. In the **Intel(R) ME Network Setup** menu, select **Intel(R) ME Network Name Settings** then press Enter.

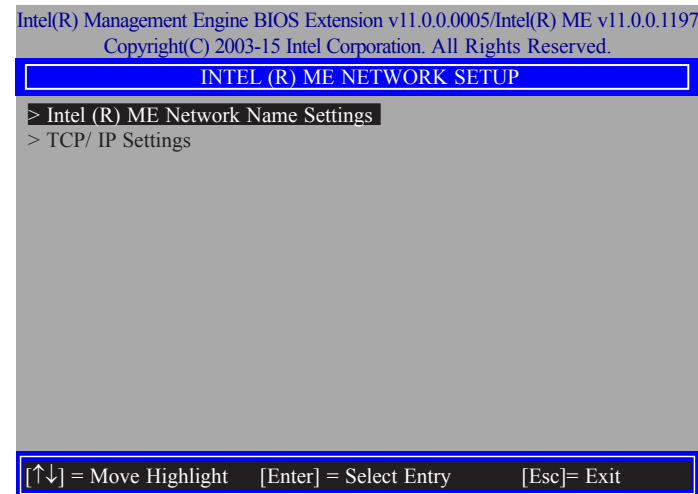

20. In the **Intel(R) ME Network Name Settings** menu, select **Host Name** then press Enter. Enter the computer's host name then press Enter.

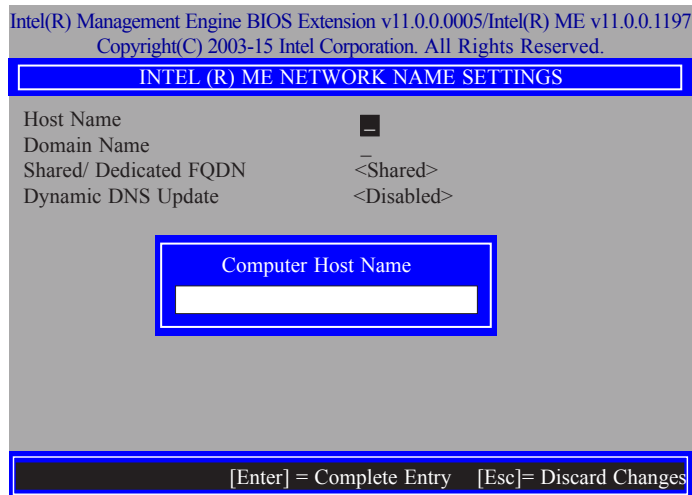

22. Select **Shared/Dedicated FQDN** then press Enter. Select **Shared** or **Dedicated** then press Enter.

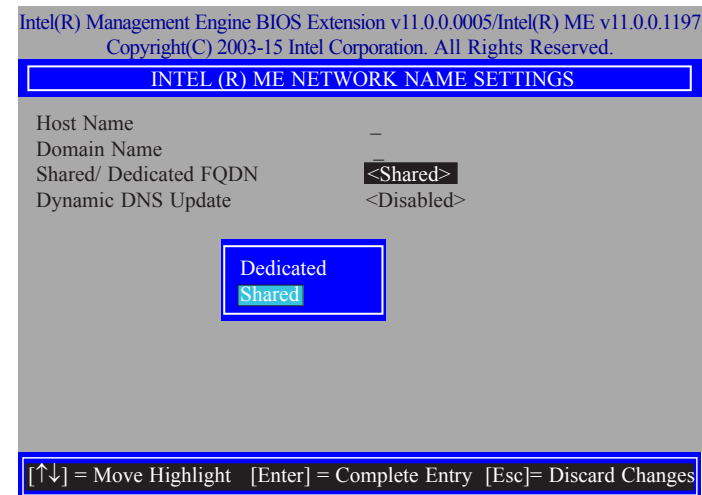

21. Select **Domain Name** then press Enter. Enter the computer's domain name then press Enter.

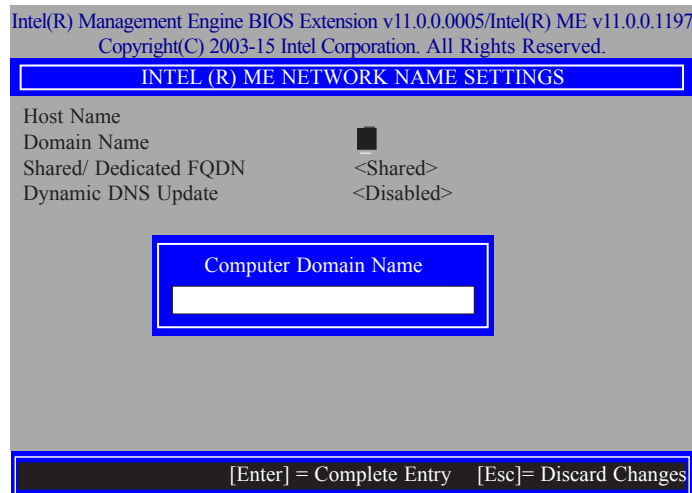

23. Select **Dynamic DNS Update** then press Enter. Select **Enabled** or **Disabled** then press Enter.

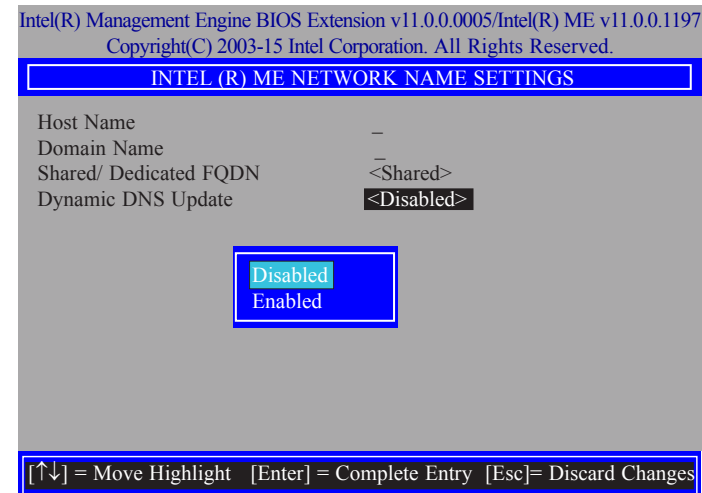

24. Select Previous Menu until you return to the **Intel(R) ME Network Setup** menu. Select **TCP/IP Settings** then press Enter.

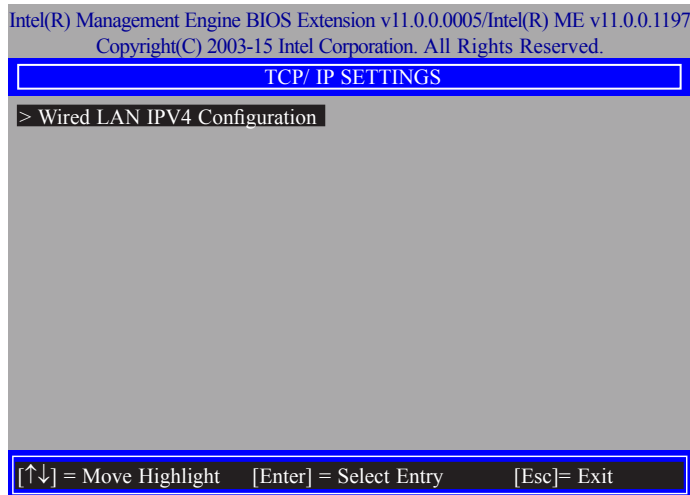

If DHCP mode is disabled, the following items will appear.

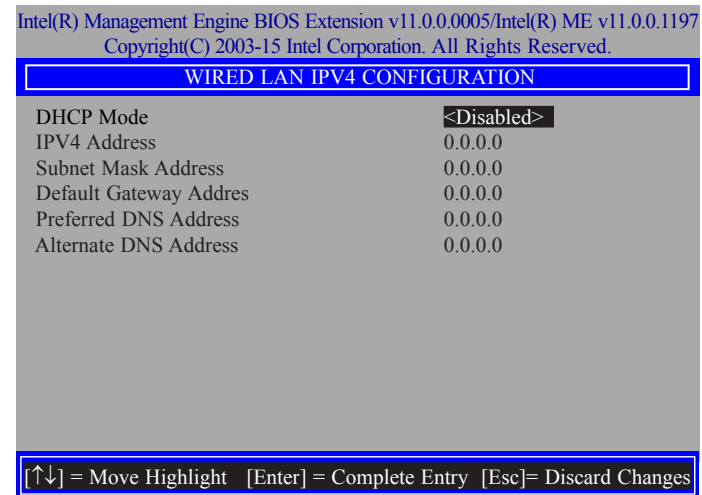

25. In the **TCP/IP Settings** menu, select **Wired LAN IPV4 Configuration** then press Enter. Select **Enabled** or **Disable IPV4 DHCP Mode** then press Enter.

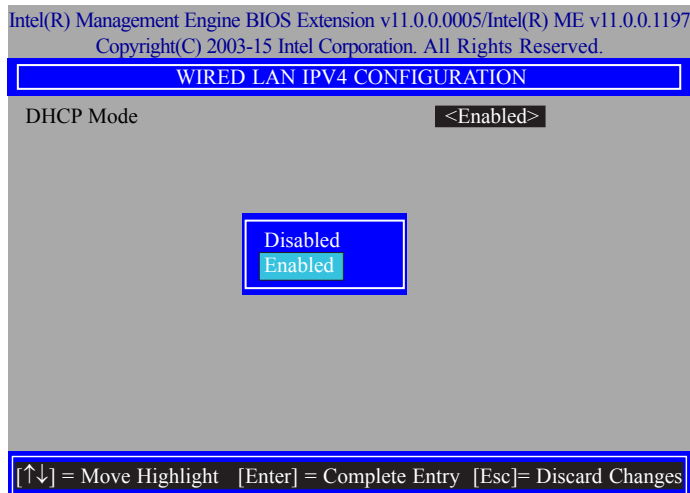

26. In the **Intel(R) AMT Configuration** menu, select **Activate Network Access** then press Enter. Press **Y** then press Enter.

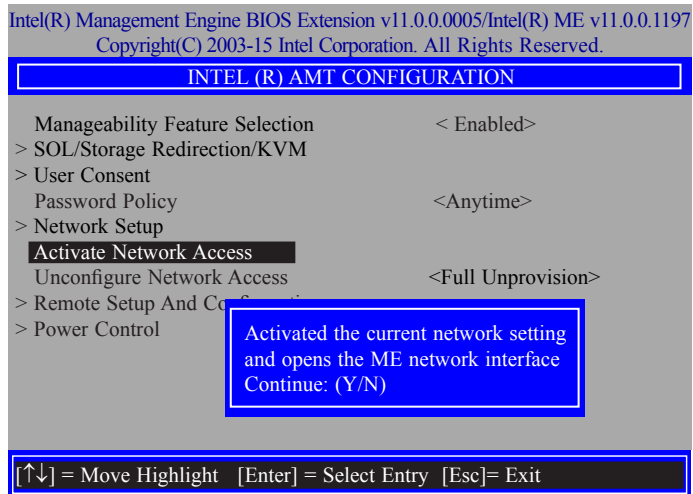

27. In the **Intel(R) AMT Configuration** menu, select **Unconfigure Network Access** then press Enter.

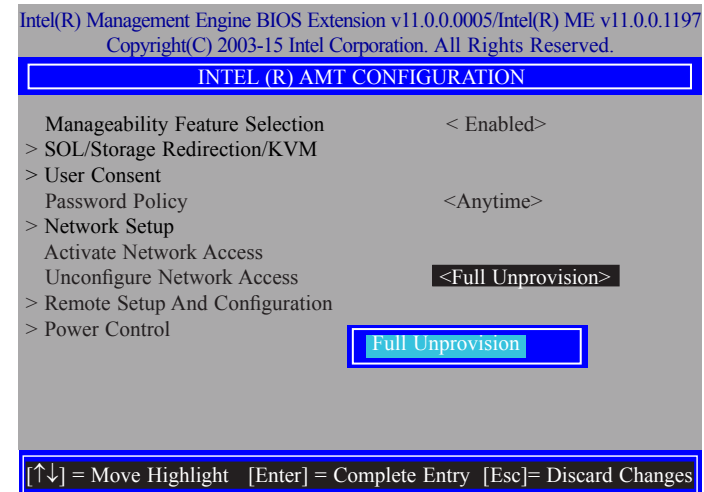

28. In the **Intel(R) AMT Configuration** menu, select **Remote Setup And Configuration** then press Enter.

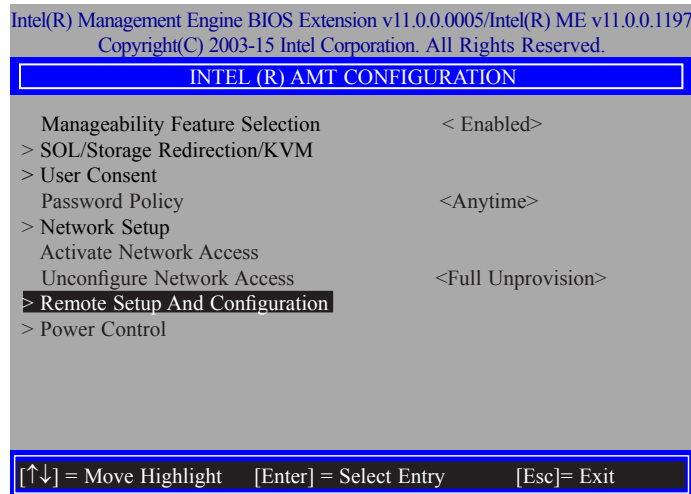

30. In the **Intel(R) Remote Setup And Configuration** menu, select **Provisioning Record** then press Enter.

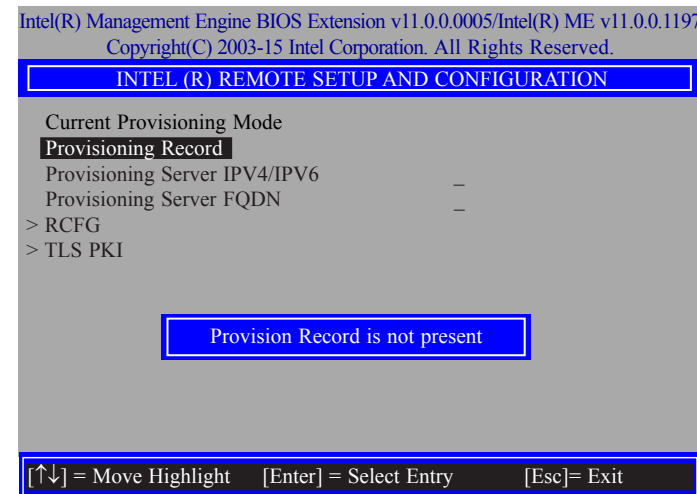

29. In the **Intel(R) Remote Setup And Configuration** menu, select **Current Provisioning Mode** then press Enter.



31. In the **Intel(R) Remote Setup And Configuration** menu, select **Provisioning server IPV4/IPV6**, enter the Provisioning server address then press Enter.

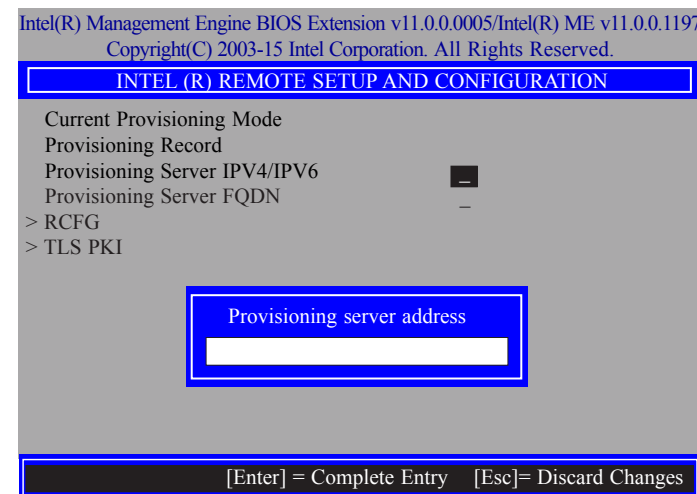

32. In the **Intel(R) Remote Setup And Configuration** menu, select **Provisioning server FQDN**, enter the FQDN of Provisioning server then press Enter.

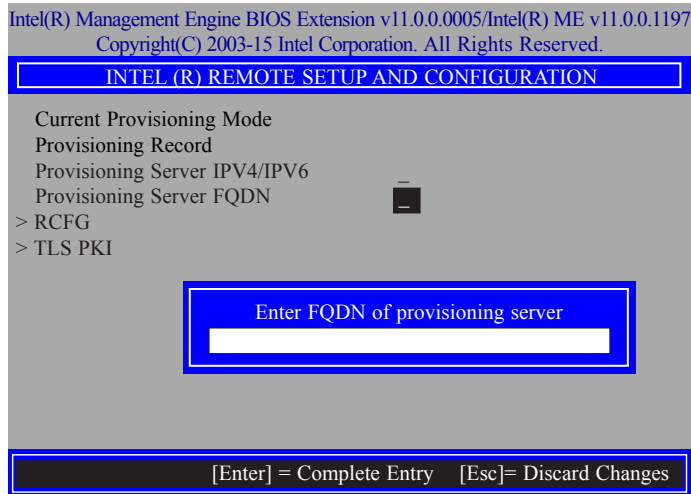

34. In the **Intel(R) Remote Setup And Configuration** menu, select **TLS PKI** then press Enter.

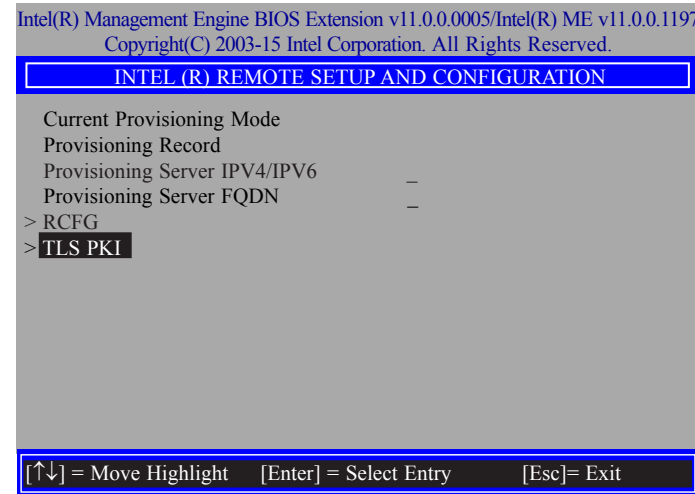

33. In the **Intel(R) Remote Setup And Configuration** menu, select **RCFG** then press Enter, and select **Start Configuration** then press enter. Type **Y** then press enter.

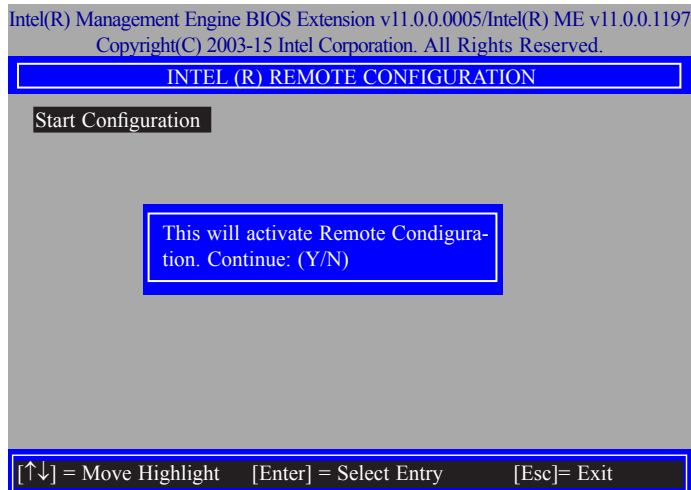

35. In the **Intel(R) Remote Configuration** menu, select **Remote Configuration**** then press Enter, select **Enabled** or **Disabled** then press Enter.

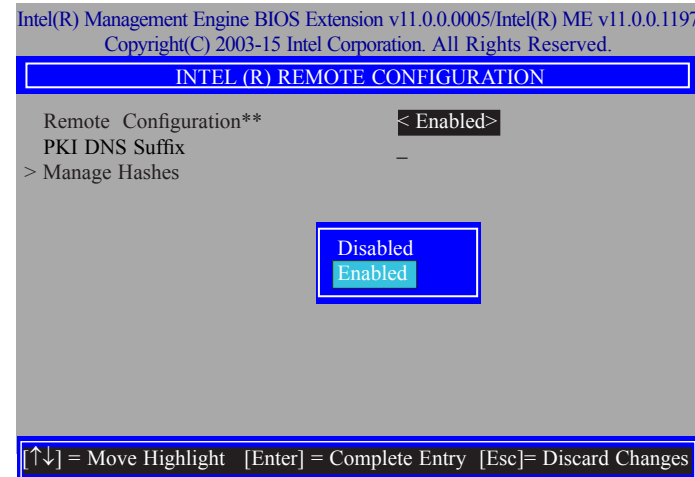

36. In the **Intel(R) Remote Configuration** menu, select **PKI DNS Suffix** then press Enter. Type PKI DNS Suffix then press Enter.

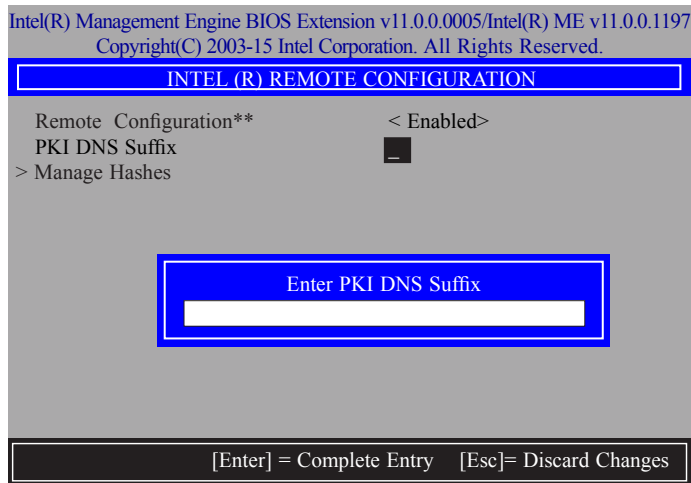

37. Select **Manage Hashes** then press Enter, and select one of hash name.

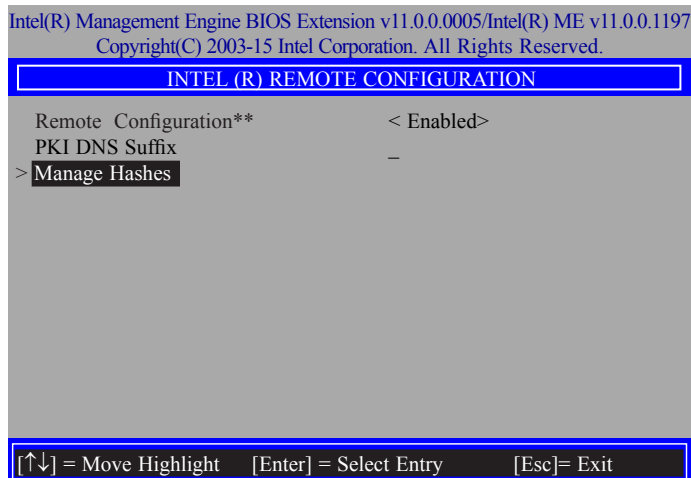

38. In the **Intel(R) Remote Configuration** menu, select **Manage Hashes** then press Enter.

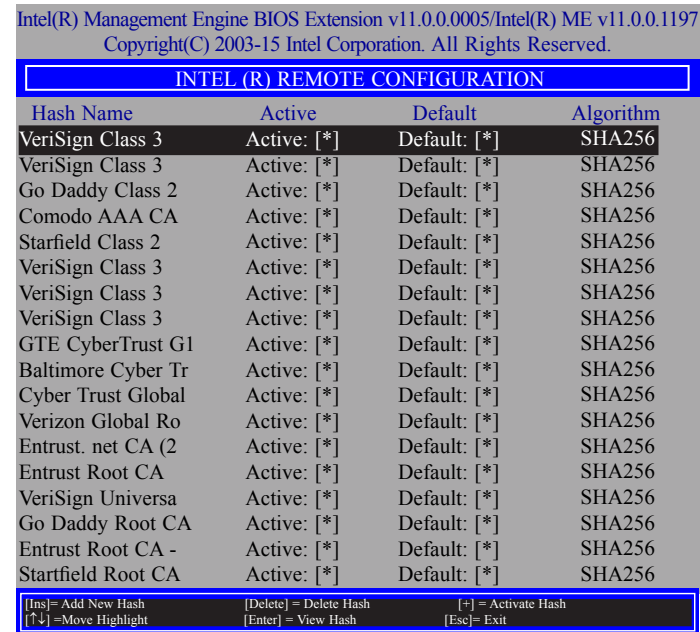

39. In the **Intel(R) AMT Configuration** menu, select **Power Control** then press Enter.

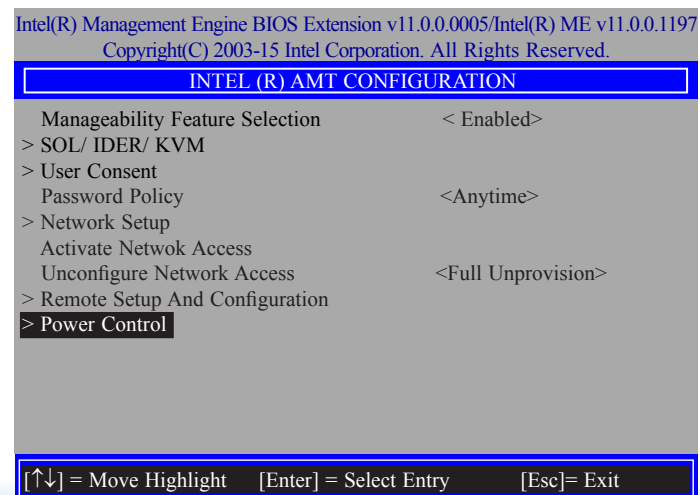

40. In the **Intel(R) AMT Power Control** menu, select **Intel(R) AMT ON in Host Sleep States** then press Enter. Select an option then press Enter.

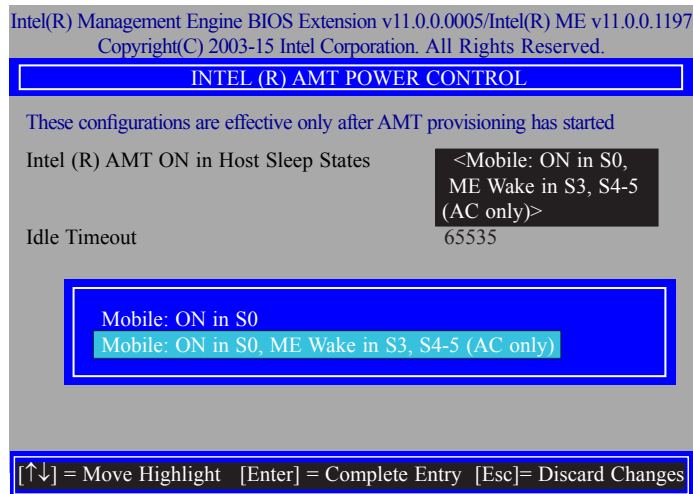

42. Select Previous Menu until you return to the **Main Menu**. Select **Exit** then press Enter. Type **Y** then press Enter.

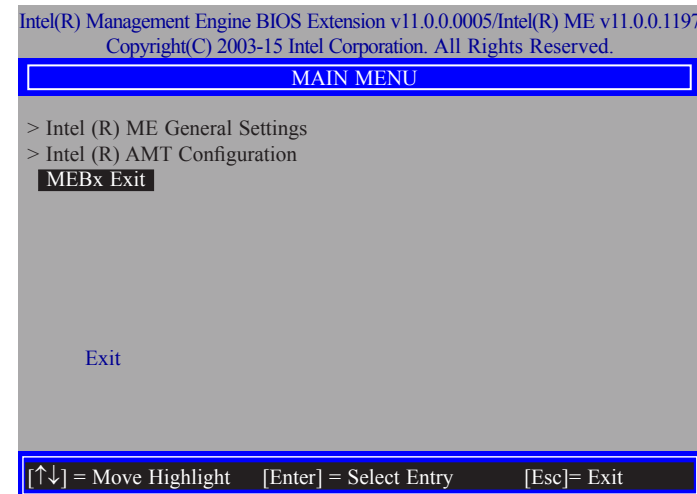

41. In the **Intel(R) AMT Power Control** menu, select **Idle Timeout** then press Enter. Enter the timeout value (1-65535).

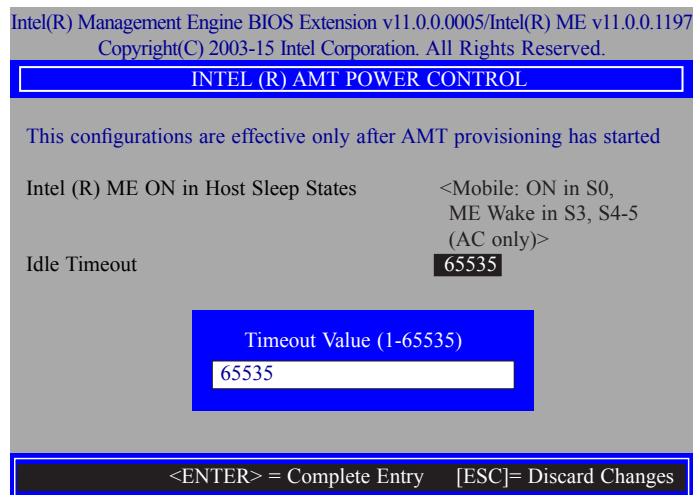

Appendix A - Troubleshooting

Troubleshooting Checklist

This chapter of the manual is designed to help you with problems that you may encounter with your personal computer. To efficiently troubleshoot your system, treat each problem individually. This is to ensure an accurate diagnosis of the problem in case a problem has multiple causes.

Some of the most common things to check when you encounter problems while using your system are listed below.

1. The power switch of each peripheral device is turned on.
2. All cables and power cords are tightly connected.
3. The electrical outlet to which your peripheral devices are connected is working. Test the outlet by plugging in a lamp or other electrical device.
4. The monitor is turned on.
5. The display's brightness and contrast controls are adjusted properly.
6. All add-in boards in the expansion slots are seated securely.
7. Any add-in board you have installed is designed for your system and is set up correctly.

Monitor/Display

If the display screen remains dark after the system is turned on:

1. Make sure that the monitor's power switch is on.
2. Check that one end of the monitor's power cord is properly attached to the monitor and the other end is plugged into a working AC outlet. If necessary, try another outlet.
3. Check that the video input cable is properly attached to the monitor and the system's display adapter.
4. Adjust the brightness of the display by turning the monitor's brightness control knob.

The picture seems to be constantly moving.

1. The monitor has lost its vertical sync. Adjust the monitor's vertical sync.
2. Move away any objects, such as another monitor or fan, that may be creating a magnetic field around the display.
3. Make sure your video card's output frequencies are supported by this monitor.

The screen seems to be constantly wavering.

1. If the monitor is close to another monitor, the adjacent monitor may need to be turned off. Fluorescent lights adjacent to the monitor may also cause screen wavering.

Power Supply

When the computer is turned on, nothing happens.

1. Check that one end of the AC power cord is plugged into a live outlet and the other end properly plugged into the back of the system.
2. Make sure that the voltage selection switch on the back panel is set for the correct type of voltage you are using.
3. The power cord may have a "short" or "open". Inspect the cord and install a new one if necessary.

Hard Drive

Hard disk failure.

1. Make sure the correct drive type for the hard disk drive has been entered in the BIOS.
2. If the system is configured with two hard drives, make sure the bootable (first) hard drive is configured as Master and the second hard drive is configured as Slave. The master hard drive must have an active/bootable partition.

Excessively long formatting period.

If your hard drive takes an excessively long period of time to format, it is likely a cable connection problem. However, if your hard drive has a large capacity, it will take a longer time to format.

Serial Port

The serial device (modem, printer) doesn't output anything or is outputting garbled characters.

1. Make sure that the serial device's power is turned on and that the device is on-line.
2. Verify that the device is plugged into the correct serial port on the rear of the computer.
3. Verify that the attached serial device works by attaching it to a serial port that is working and configured correctly. If the serial device does not work, either the cable or the serial device has a problem. If the serial device works, the problem may be due to the onboard I/O or the address setting.
4. Make sure the COM settings and I/O address are configured correctly.

Keyboard

Nothing happens when a key on the keyboard was pressed.

1. Make sure the keyboard is properly connected.
2. Make sure there are no objects resting on the keyboard and that no keys are pressed during the booting process.

System Board

1. Make sure the add-in card is seated securely in the expansion slot. If the add-in card is loose, power off the system, re-install the card and power up the system.
2. Check the jumper settings to ensure that the jumpers are properly set.
3. Verify that all memory modules are seated securely into the memory sockets.
4. Make sure the memory modules are in the correct locations.
5. If the board fails to function, place the board on a flat surface and seat all socketed components. Gently press each component into the socket.
6. If you made changes to the BIOS settings, re-enter setup and load the BIOS defaults.

Appendix B - Insyde BIOS Standard Status POST Code

SEC Phase 8-Bit POST Code Values

Functionality Name	POST Code Value	Description
SEC_SYSTEM_POWER_ON	01	CPU power on and switch to Protected mode
SEC_AFTER_MICROCODE_PATCH	03	Setup Cache as RAM
SEC_ACCESS_CSR	04	PCIE MMIO Base Address initial
SEC_GENERIC_MSRRINIT	05	CPU Generic MSR initialization
SEC_CPU_SPEEDCFG	06	Setup CPU speed
SEC_SETUP_CAR_OK	07	Cache as RAM test
SEC_FORCE_MAX_RATIO	08	Tune CPU frequency ratio to maximum level
SEC_GO_TO_SECSTARTUP	09	Setup BIOS ROM cache
SEC_GO_TO_PEICORE	0A	Enter Boot Firmware Volume

PEI Phase 8-Bit POST Code Values

Functionality Name	POST Code Value	Description
PEI_SIO_INIT	70	Super I/O initialization
PEI_CPU_REG_INIT	71	CPU Early Initialization
PEI_CPU_AP_INIT	72	Multi-processor Early initialization
PEI_CPU_HT_RESET	73	HyperTransport initialization
PEI_PCIE_MMIO_INIT	74	PCIE MMIO BAR Initialization
PEI_NB_REG_INIT	75	North Bridge Early Initialization
PEI_SB_REG_INIT	76	South Bridge Early Initialization
PEI_PCIE_TRAINING	77	PCIE Training
PEI_TPM_INIT	78	TPM Initialization
PEI_MEMORY_INSTALL	80	Simple Memory test
PEI_TXTPEI	81	TXT function early initialization
PEI_MEMORY_CALLBACK	83	Set cache for physical memory

DXE Phase 8-Bit POST Code Values

Functionality Name	Post Code Values	Description
DXE_SB_SPI_INIT	41	South bridge SPI initialization
DXE_VARIABLE_RECLAIM	61	Variable store garbage collection and reclaim operation
DXE_FLASH_PART_NONSUPPORT	62	Flash part not supported.

BDS Phase 8-Bit POST Code Values

Functionality Name	POST Code Value	Description
BDS_ENTER_BDS	10	Enter BDS entry
BDS_INSTALL_HOTKEY	11	Install Hotkey service
BDS_ASF_INIT	12	ASF Initialization
BDS_PCI_ENUMERATION_START	13	PCI enumeration
BDS_BEFORE_PCIIO_INSTALL	14	PCI resource assign complete
BDS_PCI_ENUMERATION_END	15	PCI enumeration complete
BDS_CONNECT_CONSOLE_IN	16	Keyboard Controller, Keyboard and Mouse initializatio
BDS_CONNECT_CONSOLE_OUT	17	Video device initialization
BDS_CONNECT_STD_ERR	18	Error report device initialization
BDS_CONNECT_USB_HC	19	USB host controller initialization
BDS_CONNECT_USB_BUS	1A	USB BUS driver initialization
BDS_CONNECT_USB_DEVICE	1B	USB device driver initialization
BDS_NO_CONSOLE_ACTION	1C	Console device initialization fail
BDS_ENUMERATE_ALL_BOOT_OPTIO	27	Get boot device information
BDS_ENTER_SETUP	29	Enter Setup Menu
BDS_ENTER_BOOT_MANAGER	2A	Enter Boot manager
BDS_READY_TO_BOOT_EVENT	2E	Last Chipset initialization before boot to OS
BDS_GO_LEGACY_BOOT	2F	Start to boot Legacy OS
BDS_GO_UEFI_BOOT	30	Start to boot UEFI OS
BDS_LEGACY16_PREPARE_TO_BOOT	31	Prepare to Boot to Legacy OS
BDS_EXIT_BOOT_SERVICES	32	Send END of POST Message to ME via HECI

PostBDS Phase 8-Bit POST Code Values

Functionality Name	POST Code Value	Description
POST_BDS_NO_BOOT_DEVICE	F9	No Boot Device
POST_BDS_JUMP_BOOT_SECTOR	FE	Try to Boot with INT 19

ACPI 8-Bit POST Code Values

Functionality Name	POST Code Value	Description
ASL_ENTER_S1	51	Prepare to enter S1
ASL_ENTER_S3	53	Prepare to enter S3
ASL_ENTER_S4	54	Prepare to enter S4
ASL_ENTER_S5	55	Prepare to enter S5
ASL_WAKEUP_S1	E1	System wakeup from S1
ASL_WAKEUP_S3	E3	System wakeup from S3
ASL_WAKEUP_S4	E4	System wakeup from S4
ASL_WAKEUP_S5	E5	System wakeup from S5

SMM 8-Bit POST Code Values

Functionality Name	POST Code Value	Description
SMM_ACPI_ENABLE_END	A7	ACPI enable function complete
SMM_S1_SLEEP_CALLBACK	A1	Enter S1
SMM_S3_SLEEP_CALLBACK	A3	Enter S3
SMM_S4_SLEEP_CALLBACK	A4	Enter S4
SMM_S5_SLEEP_CALLBACK	A5	Enter S5