



# **GM341-GHF**

## **Gaming Computing System**

### **User's Manual**

## Copyright

This publication contains information that is protected by copyright. No part of it may be reproduced in any form or by any means or used to make any transformation/adaptation without the prior written permission from the copyright holders.

This publication is provided for informational purposes only. The manufacturer makes no representations or warranties with respect to the contents or use of this manual and specifically disclaims any express or implied warranties of merchantability or fitness for any particular purpose. The user will assume the entire risk of the use or the results of the use of this document. Further, the manufacturer reserves the right to revise this publication and make changes to its contents at any time, without obligation to notify any person or entity of such revisions or changes.

Changes after the publication's first release will be based on the product's revision. The website will always provide the most updated information.

© 2019. All Rights Reserved.

## Trademarks

Product names or trademarks appearing in this manual are for identification purpose only and are the properties of the respective owners.

## FCC and DOC Statement on Class B

This equipment has been tested and found to comply with the limits for a Class B digital device, pursuant to Part 15 of the FCC rules. These limits are designed to provide reasonable protection against harmful interference when the equipment is operated in a residential installation. This equipment generates, uses and can radiate radio frequency energy and, if not installed and used in accordance with the instruction manual, may cause harmful interference to radio communications. However, there is no guarantee that interference will not occur in a particular installation. If this equipment does cause harmful interference to radio or television reception, which can be determined by turning the equipment off and on, the user is encouraged to try to correct the interference by one or more of the following measures:

- Reorient or relocate the receiving antenna.
- Increase the separation between the equipment and the receiver.
- Connect the equipment into an outlet on a circuit different from that to which the receiver is connected.
- Consult the dealer or an experienced radio TV technician for help.

### Notice:

1. The changes or modifications not expressly approved by the party responsible for compliance could void the user's authority to operate the equipment.
2. Shielded interface cables must be used in order to comply with the emission limits.

# Table of Contents

About this Manual .....	4	Chapter 4 - Jumper Settings.....	14
Warranty .....	4	Clear CMOS Data .....	14
Static Electricity Precautions .....	4	FPGA Programming Mode Select.....	14
Safety Measures.....	4	MCU Programming Mode.....	15
Safety Precautions .....	5	Chapter 5 - Ports and Connectors .....	16
About the Package.....	5	Audio Ports.....	16
Before Using the System .....	5	USB Ports.....	17
Chapter 1 - Introduction.....	6	DC-in.....	17
Overview.....	6	COM Ports .....	18
Key Features .....	6	RJ45 LAN Ports .....	19
Specifications.....	7	Intrusion Doors.....	19
Getting to Know the GM341-GHF.....	8	Display Outputs .....	20
Mechanical Dimensions .....	9	Digital Inputs/Outputs .....	20
Chassis Dimension .....	9	Expansion Connectors.....	22
Chapter 3 - Installing Devices.....	11	CPU/System Fan Connector .....	22
Connecting the I/O Board .....	11	LEDs.....	23
Powering on the System and Connecting the Display.....	11	Battery .....	23
Removing the Chassis Cover.....	12	SATA (Serial ATA) Connectors.....	24
Installing the SODIMM .....	12	LPC Connector .....	24
Installing an M.2 card .....	13	5V DC-out.....	25
Installing a SATA DOM .....	13	Chapter 6 - Mounting.....	26
		Chapter 7 - BIOS Setup .....	27
		Chapter 8 - Supported Software .....	42

## About this Manual

An electronic file of this manual can be obtained from the DFI website at [www.dfi.com](http://www.dfi.com). To download the user's manual from our website, please go to Support > Download Center. On the Download Center page, select your product or type the model name and click "Search" to find all technical documents including the user's manual for a specific product.

## Warranty

1. Warranty does not cover damages or failures that arised from misuse of the product, inability to use the product, unauthorized replacement or alteration of components and product specifications.
2. The warranty is void if the product has been subjected to physical abuse, improper installation, modification, accidents or unauthorized repair of the product.
3. Unless otherwise instructed in this user's manual, the user may not, under any circumstances, attempt to perform service, adjustments or repairs on the product, whether in or out of warranty. It must be returned to the purchase point, factory or authorized service agency for all such work.
4. We will not be liable for any indirect, special, incidental or consequential damages to the product that has been modified or altered.

## Static Electricity Precautions

It is easy to inadvertently damage your PC, system board, components or devices even before installing them in your system unit. Static electrical discharge can damage computer components without causing any signs of physical damage. You must take extra care in handling them to ensure against electrostatic build-up.

1. To prevent electrostatic build-up, leave the system board in its anti-static bag until you are ready to install it.
2. Wear an antistatic wrist strap.
3. Do all preparation work on a static-free surface.
4. Hold the device only by its edges. Be careful not to touch any of the components, contacts or connections.
5. Avoid touching the pins or contacts on all modules and connectors. Hold modules or connectors by their ends.



### Important:

Electrostatic discharge (ESD) can damage your processor, disk drive and other components. Perform the upgrade instruction procedures described at an ESD workstation only. If such a station is not available, you can provide some ESD protection by wearing an antistatic wrist strap and attaching it to a metal part of the system chassis. If a wrist strap is unavailable, establish and maintain contact with the system chassis throughout any procedures requiring ESD protection.

## Safety Measures

To avoid damage to the system:

- Use the correct AC input voltage range.

To reduce the risk of electric shock:

- Unplug the power cord before removing the system chassis cover for installation or servicing. After installation or servicing, cover the system chassis before plugging the power cord.

Battery:

- Danger of explosion if battery incorrectly replaced.
- Replace only with the same or equivalent type recommend by the manufacturer.
- Dispose of used batteries according to local ordinance.

## Safety Precautions

- Use the correct DC input voltage range.
- Unplug the power cord before removing the system chassis cover for installation or servicing. After installation or servicing, cover the system chassis before plugging the power cord.
- Danger of explosion if battery incorrectly replaced.
- Replace only with the same or equivalent type recommend by the manufacturer.
- Dispose of used batteries according to local ordinance.
- Keep this system away from humidity.
- Place the system on a stable surface. Dropping it or letting it fall may cause damage.
- The openings on the system are for air ventilation to protect the system from overheating. **DO NOT COVER THE OPENINGS.**
- Place the power cord in such a way that it will not be stepped on. Do not place anything on top of the power cord. Use a power cord that has been approved for use with the system and that it matches the voltage and current marked on the system's electrical range label.
- If the system will not be used for a long time, disconnect it from the power source to avoid damage by transient overvoltage.
- If one of the following occurs, consult a service personnel:
  - The power cord or plug is damaged.
  - Liquid has penetrated the system.
  - The system has been exposed to moisture.
  - The system is not working properly.
  - The system dropped or is damaged.
  - The system has obvious signs of breakage.
- The unit uses a three-wire ground cable which is equipped with a third pin to ground the unit and prevent electric shock. Do not defeat the purpose of this pin. If your outlet does not support this kind of plug, contact your electrician to replace the outlet.
- Disconnect the system from the DC outlet before cleaning. Use a damp cloth. Do not use liquid or spray detergents for cleaning.

## About the Package

The package contains the following items. If any of these items are missing or damaged, please contact your dealer or sales representative for assistance.

- GM341-GHF system unit
- Mounting screws for M.2 modules
- CD disk includes
  - Manual
  - Drivers
- Quick Installation Guide

The board and accessories in the package may not come similar to the information listed above. This may differ in accordance to the sales region or models in which it was sold. For more information about the standard package in your region, please contact your dealer or sales representative.

## Before Using the System

Before powering-on the system, prepare the basic system components.

If you are installing the system for the first time, you will need at least one of the following internal components.

- Storage devices such as SATA DOMs and M.2 modules.

You will also need external system peripherals, which will normally include at least a keyboard, a mouse and a video display.

## Chapter 1 - Introduction

### Overview

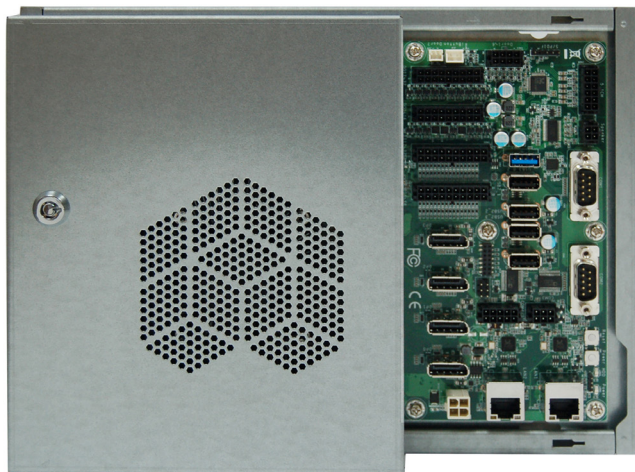

### Key Features

<b>Model Name</b>	<b>GM341-GHF</b>
<b>Processor</b>	AMD® Ryzen™ Embedded V1000/R1000/R2000 processors
<b>Audio</b>	Speaker and 5.1 Channel Audio Output S/PDIF Digital Output
<b>LAN</b>	Two LAN ports
<b>COM</b>	One RS-232 (DB-9 connector) One RS-232/422/485 (DB-9 connector) One RS-232 (Tx, Rx)/ccTalk (pin headers) Two RS-232 (Tx, Rx)/SAS/BACTA (pin headers)
<b>Display</b>	Four DP
<b>USB</b>	Two USB 3.0 and four USB 2.0 Type A ports

<b>Processor System</b>	<p>AMD® Ryzen™ Embedded V1807, Quad Core, 2MB Cache, 11 CU, 3.35GHz (3.8GHz), 35-54W                  AMD® Ryzen™ Embedded V1756, Quad Core, 2MB Cache, 8 CU, 3.25GHz (3.6GHz), 35-54W                  AMD® Ryzen™ Embedded V1605, Quad Core, 2MB Cache, 8 CU, 2.0GHz (3.6GHz), 12-25W                  AMD® Ryzen™ Embedded V1202, Dual Core, 1MB Cache, 3 CU, 2.3GHz (3.2GHz), 12-25W                  AMD® Ryzen™ Embedded R1606G, 2C/4T, 3 CU, 2.6GHz (3.5GHz), 15W                  AMD® Ryzen™ Embedded R1505G, 2C/4T, 3 CU, 2.4GHz(3.3GHz),15W                  AMD® Ryzen™ Embedded R2312, 3C/4T, 2MB Cache, 3CU, 2.7GHz (3.5GHz), 12~25W                  AMD® Ryzen™ Embedded R2314, 6C/12T, 4MB Cache, 6 CU, 2.1GHz (3.5GHz), 12~35W                  AMD® Ryzen™ Embedded R2514, 6C/12T, 4MB Cache, 8 CU, 2.1GHz (3.7GHz), 12~35W                  AMD® Ryzen™ Embedded R2544, 4C/8T, 4MB Cache, 8 CU, 3.35GHz (3.7GHz), 35~54W</p>
<b>Memory</b>	<p>Two 260-pin SODIMM up to 32GB                  Dual Channel DDR4 3200MHz</p>
<b>Graphics</b>	<ul style="list-style-type: none"> <li>• AMD® Radeon™ Vega Graphics</li> <li>• Supported codecs:                      OpenGL 4.5, DirectX 12, OpenCL 2.1                      HW Decode: AVC/H.264, MPEG2, VC1/WMV9, JPEG/MJPEG, HEVC/H265, VP8, VP9                      HW Encode: MPEG2, AVC/H264, JPEG, HEVC/H265, VP8, VP9</li> <li>• Display interfaces:                      4 x DP++ ( with V1000 series processors) or 3 x DP++ (with R1000 series processors)                      DP: resolution up to 4096x2160 @ 60Hz</li> </ul>
<b>Audio</b>	<p>5.1 Channel Audio Output                  S/PDIF Digital Output                  Stereo 10W+10W Class D Audio AMP Output</p>
<b>Storage/Expansion</b>	<ul style="list-style-type: none"> <li>• 2 x SATA 3.0 (up to 6GB/s) with 7-pin VCC Support</li> <li>• 1 x M.2 M Key (2280, PCIe x2, only available with Ryzen™ V1000 series processors)</li> </ul>
<b>Ethernet</b>	2 x Realtek 8119 or 8111HN (optional) Gigabit Ethernet Controller
<b>GAMING</b>	<p><b>Intrusion Detection</b>                  8 x Intrusion Detections                  Operates With and Without AC Power                  Logs Date/Time of Last 64 Events 5 Years Data Retention during AC off</p> <p><b>NVRAM</b>                  Supports up to 16Mbyte                  Coin Battery Backup to Retain Data for 5 Years during AC off Supports                  Battery Voltage Monitoring &amp; Warning</p> <p><b>DI/DO</b>                  32-bit Digital Input                  32-bit OC output (29-bit x 500mA, support 8 meter with disconnect detection; 3-bit x 3A)</p> <p><b>iButton</b>                  Support iButton 1-wire protocol</p>

<b>I/O Ports and LED Indicators</b>	<ul style="list-style-type: none"> <li>• LEDs                         <ul style="list-style-type: none"> <li>- 1 x Power LED</li> <li>- 1 x HDD LED</li> </ul> </li> <li>• I/O Ports                         <ul style="list-style-type: none"> <li>1 x RS-232 (DB-9 connector)</li> <li>1 x RS-232/422/485 (DB-9 connector)</li> <li>1 x RS-232 (Tx, Rx)/ccTalk (pin header)</li> <li>2 x RS-232 (Tx, Rx)/SAS/BACTA (pin header)</li> <li>2 x USB 3.0</li> <li>4 x USB 2.0</li> </ul> </li> <li>Digital I/O                      DI: 1~32                      DO: 1~32</li> <li>Intrusion detection doors: 1~8</li> <li>• Button                      Power Button                      Reset Button</li> </ul>
<b>Power</b>	• 12V DC-in (4-pin Vertical Connector)
<b>Environment</b>	<ul style="list-style-type: none"> <li>• Temperature                         <ul style="list-style-type: none"> <li>- Operating: 0°C ~ 45°C</li> <li>- Storage: -20°C ~ 85°C</li> </ul> </li> <li>• Relative Humidity                         <ul style="list-style-type: none"> <li>- 5 to 90% RH (non-condensing)</li> </ul> </li> </ul>
<b>Vibration</b>	<ul style="list-style-type: none"> <li>• Operation:                      IEC 60068-2-64 Test Fh: Vibration Board-Band Random Test Random, 1Grms @ 5~500 Hz, 30min.</li> <li>• Non-Operation:                      IEC 60068-2-6 Test Fc: Vibration Sinusoidal Test Sweep sine, 3Grms @ 10~500Hz, 30min.</li> </ul>
<b>Shock</b>	<ul style="list-style-type: none"> <li>• Operation:                      IEC 60068-2-27 Test Ea: Shock test Half-sine, 3G @ 11ms, 18 Shock ±X, ±Y, ±Z (each axis 3 times)</li> <li>• Non-Operation:                      IEC 60068-2-27 Test Ea: Shock test Half-sine, 5G @ 11ms, 18 Shock ±X, ±Y, ±Z (each axis 3 times)</li> </ul>
<b>Construction</b>	• Aluminum + Metal Aluminum
<b>Mounting</b>	• Wall mount (*)
<b>Dimensions (W x H x D)</b>	• 270mm x 63mm x 210mm (10.63" x 2.48" x 8.27")
<b>Weight</b>	• TBD
<b>OS Support</b>	Windows 10 (64-bit) Ubuntu 16.04LTS (64-bit)

 **Note:**  
 \*The mount kit is not supported in the standard model. Please contact your sales representative for more information.

## Getting to Know the GM341-GHF

### Front View

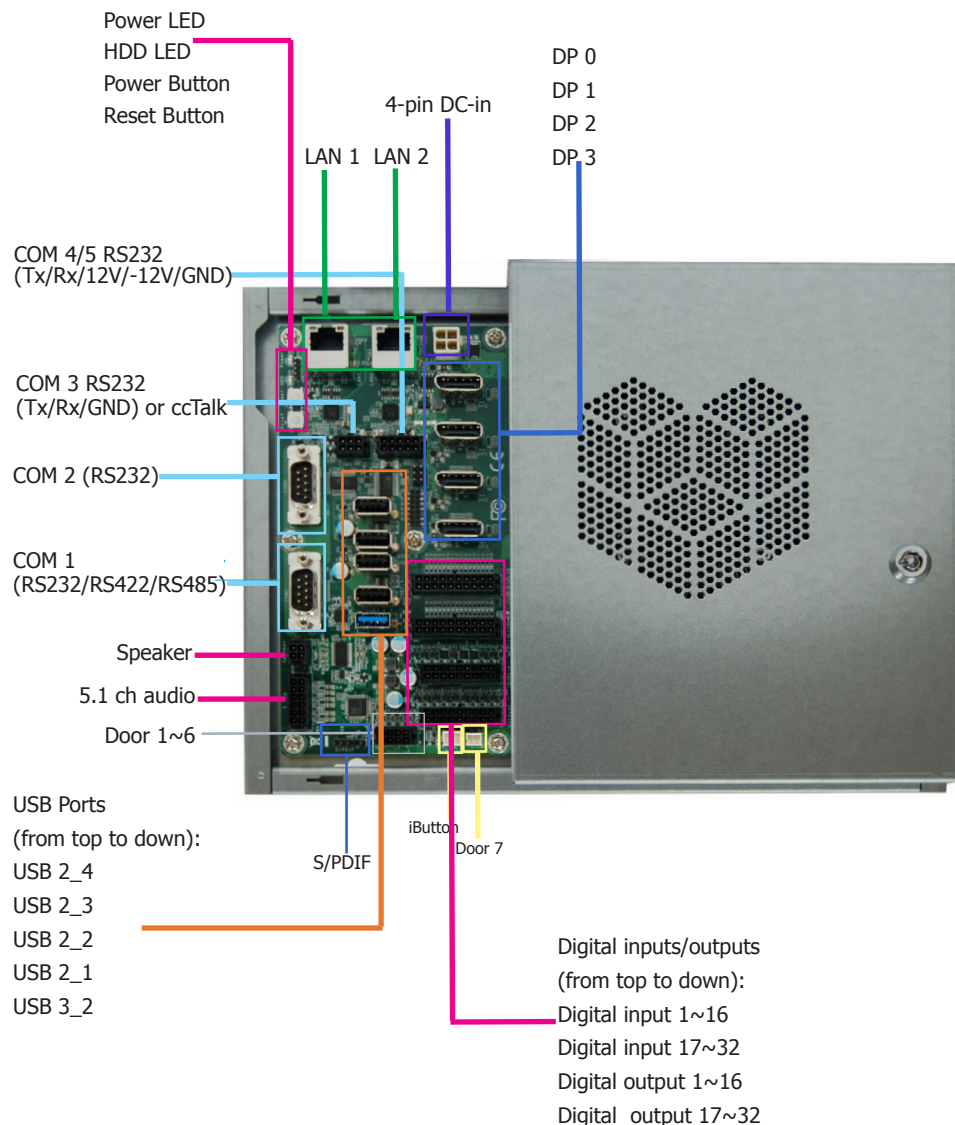

### Speaker and 5.1 ch audio

Connects an audio I/O module to the 4-pin speaker connector for stereo (10W+10W) speakers and 5.1 ch audio connector for audio sound systems; there is also an S/PDIF digital audio connector.

### Digital I/O

32 digital inputs via 2x10 micro-fit connector  
32 digital outputs via 2x9 micro-fit connector

### LAN Ports

Connect the system to a local area network.

### DC-in

DC 12V power input via a 4-pin connector.

### DP Ports (DP 0~3)

Connect the DisplayPort of a display device.

### USB 2.0 & 3.0 Ports

4 USB 2.0 ports and 2 USB 3.0 ports (one in the I/O area and the other in the system area protected by a cover)

### COM ports

**COM1 (DB-9):** connects RS232/RS422/RS485 devices.

**COM2 (DB-9):** connects RS232 devices.

**COM3:** connects RS232 with Tx/Rx/GND or ccTalk

**COM4/5:** connects RS232 with Tx/Rx/+12V/-12V/GND

### Power LED

Indicates the status of the system.

### HDD LED

Indicates the status of the storage device.

### Power Button

Press to power on or off the system.

### Reset Button

Press to reset the system.

### Intrusion Doors Connectors

6 doors via a 2x4 micro-fit connector

1 door via a 2-pin box header in the I/O area

1 door via a 2-pin box header in the protected system area



## Mechanical Dimensions

### Chassis Dimension

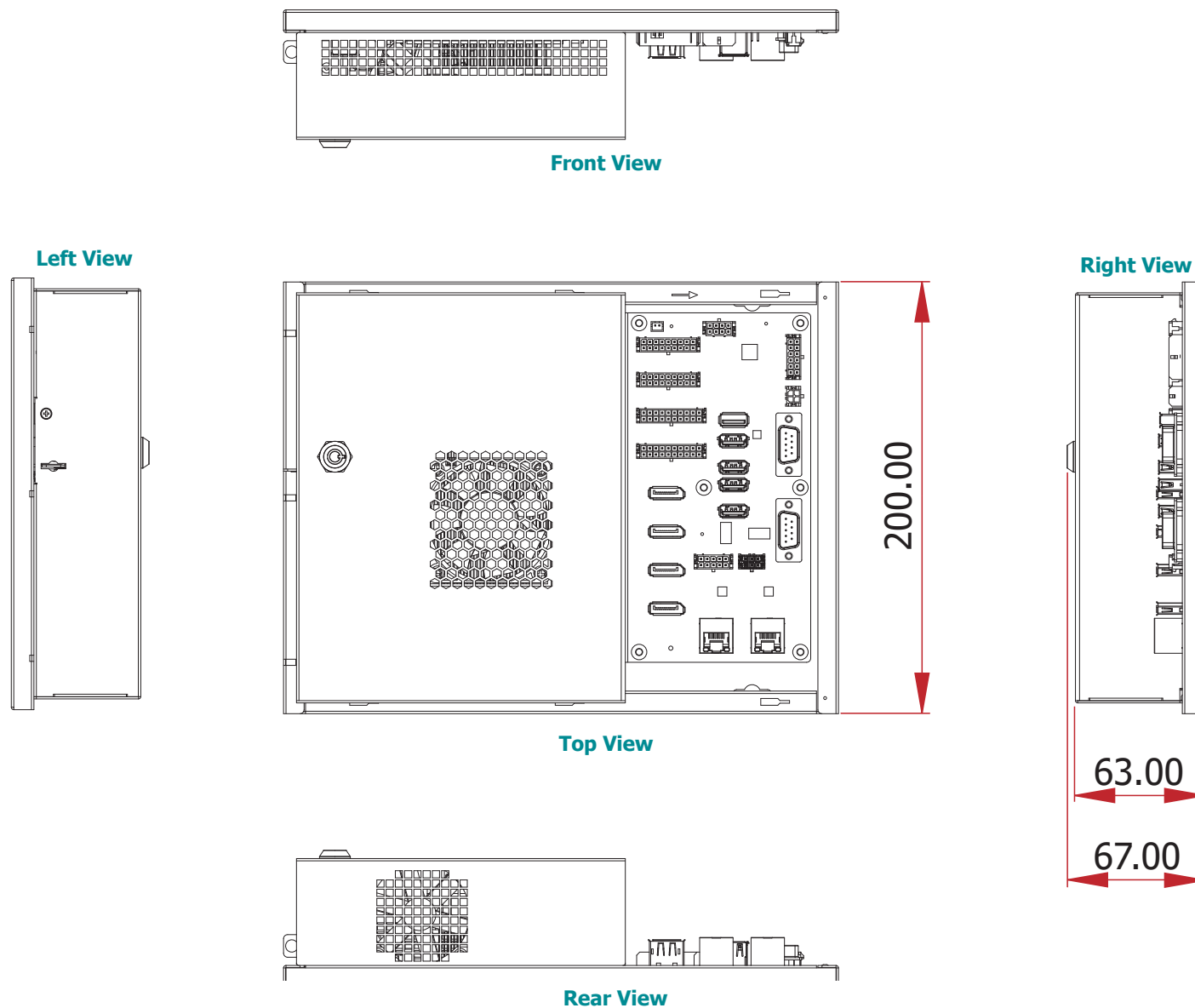

## Chapter 2 - Getting Started

---

### Preparing the System

Before you start using the system, you need the following items:

- SATA DOMs or M.2 modules
- USB keyboard
- USB mouse
- CD-ROM drive (for installing software/drivers)
- Screwdriver
- Memory modules

### Installing Devices

The following devices can be installed in the system.

- Memory modules
- SATA DOMs
- M.2 modules

### Configuring the BIOS

To get you started, you may need to change configurations such as the date, time and the priority of boot devices.

1. Power on the system.
2. After the memory test, the message "Press DEL to run setup" will appear on the screen. Press the Delete key to enter the BIOS setup utility.

### Installing a Operating System

Most operating system software can be installed using a DVD (and DVD burner) or bootable USB drive.

Please refer to your operating system manual for instructions on installing an operating system.

### Installing the Drivers

The system comes with a software package including drivers. These drivers must be installed to provide the best system performance. Refer to the Supported Software Chapter for instructions on installing drivers.

## Chapter 3 - Installing Devices

### Connecting the I/O Board

The system supports 32 digital inputs and outputs. The I/O board that came with the package can be connected to the system to test the digital input and output function. Please observe the following guidelines and follow the procedure to connect the I/O board.

1. Make sure the system and all other peripheral devices connected to it have been powered off.
2. Disconnect all power cords and cables.
3. Connect one end of the USB cable (type-A connector) to the system and the other end of the USB cable (type-B connector) to the I/O board.
4. Connect the I/O board to the system's intrusion detection connector (labeled door 1~6) using the red cable.
5. Connect the I/O board to the system's DIO port (labeled DO: 17~32) using the blue cable.
6. Connect the I/O board to the system's DIO port (labeled DO: 1~16) using the green cable.
7. Connect the I/O board to the system's DIO port (labeled DI: 17~32) using the yellow cable.
8. Connect the I/O board to the system's DIO port (labeled DI: 1~16) using the orange cable.

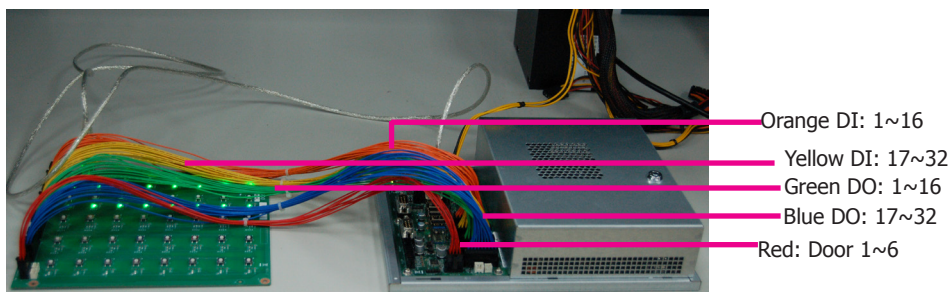

#### Note:

The tact buttons on the I/O board can be used to invoke a door intrusion event or set the high/low level of a digital I/O port. You can also use the demonstration application to alter a digital I/O port's level. For more information, please refer to the software application guide.

### Powering on the System and Connecting the Display

To power on the system, simply connect the 4-pin power cable to the system and the system will be automatically powered on. If you want to use a power or a reset switch (tact button), they are located on the system board as shown in the following picture.

To connect the display, use a DisplayPort cable to connect one of the DP ports to a display device.

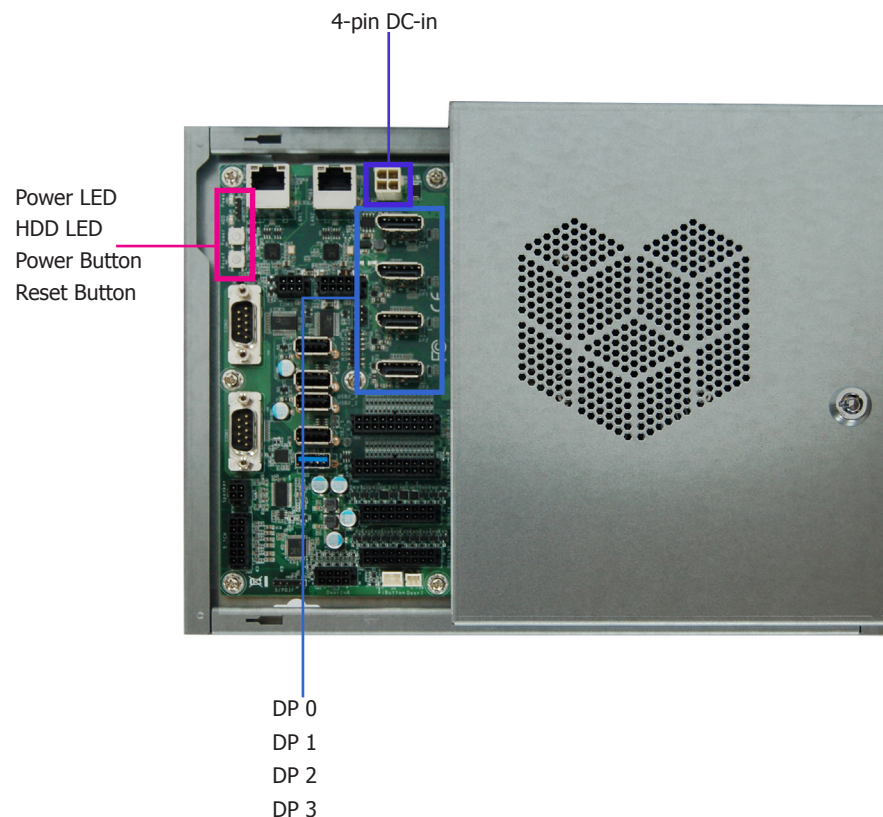

## Removing the Chassis Cover

Please observe the following guidelines before opening the chassis cover:

1. Make sure the system and all other peripherals connected to it have been powered off.
2. Disconnect all power cords and cables.
3. The mounting screw on the rear side of the system compartment is used to secure the cover to the chassis. Remove this screw and put it in a safe place for later use.
4. Use the key (push it down slightly and turn it counterclockwise) to unlock the system compartment cover.
5. Slide the cover backward to open the chassis cover.

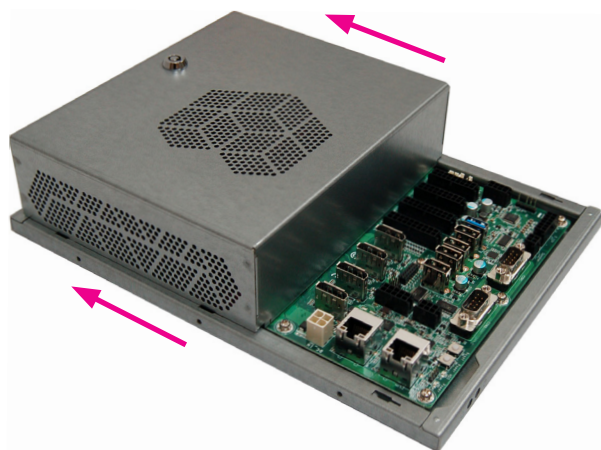
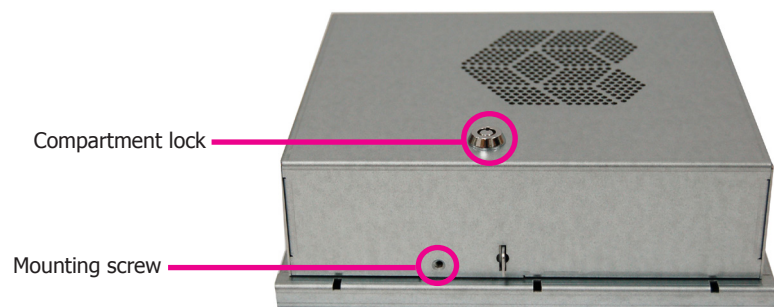

## Installing the SODIMM

Grasp the module by its edges and align the memory's notch with the socket's notch; then insert the memory into the socket at an angle and push it down until you feel a click.

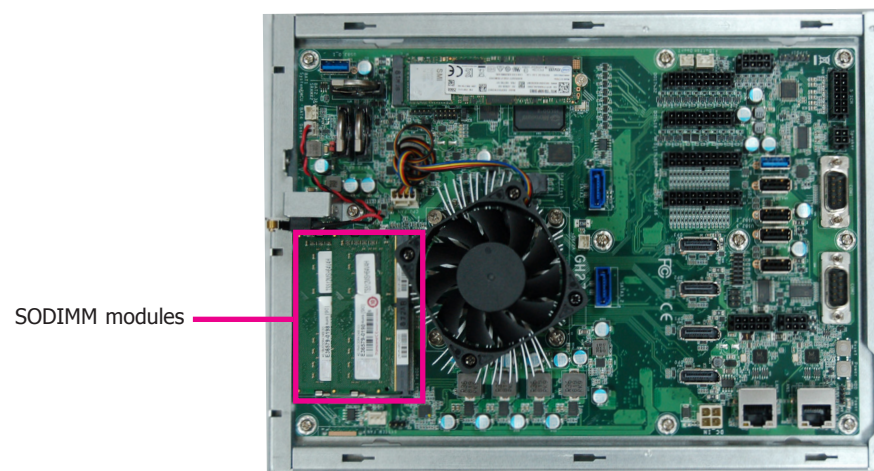
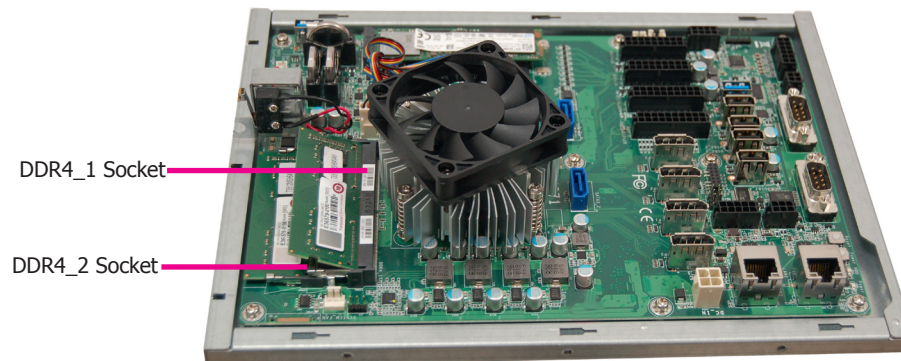

### Notes:

1. The system supports dual-channel configuration. To enable dual-channel, populate both SODIMM sockets.
2. The SODIMM sockets can only accept DDR4 (3200MHz) memory modules. Please do not install other types of memory modules.

## Installing an M.2 card

The system (only with the V1000-series CPUs) has one M.2 type 2280 socket (M Key), which provides PCIe NVMe x2 interface that supports the installation of M.2 22 x 80mm SSD cards:

1. Align the notch at the edge of the M.2 card with the key in the connector.
2. Push down on the other end of the card and use the provided mounting screw (the longer one) to secure both cards on the system board.

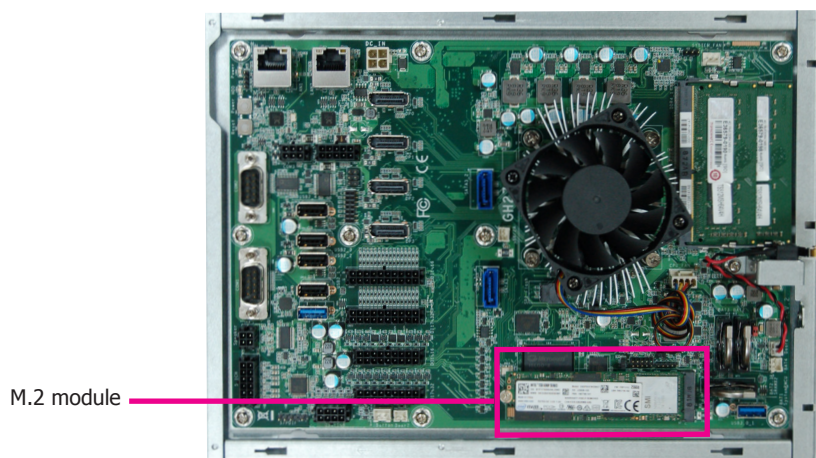
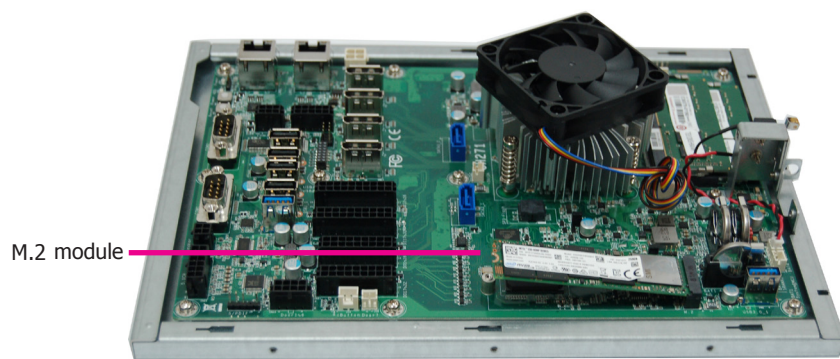

## Installing a SATA DOM

The system board is equipped with two SATA 3.0 ports that support the installation of SATA DOMs that can be used as a boot drive, system backup and recovery device, etc.

These SATA ports provide power so external power supply is not needed. However, if such power supply is required, the board is equipped with a 2-pin 5V/2A DC-out connector. Align the SATA port with the connector of a SATA DOM before inserting the SATA DOM.

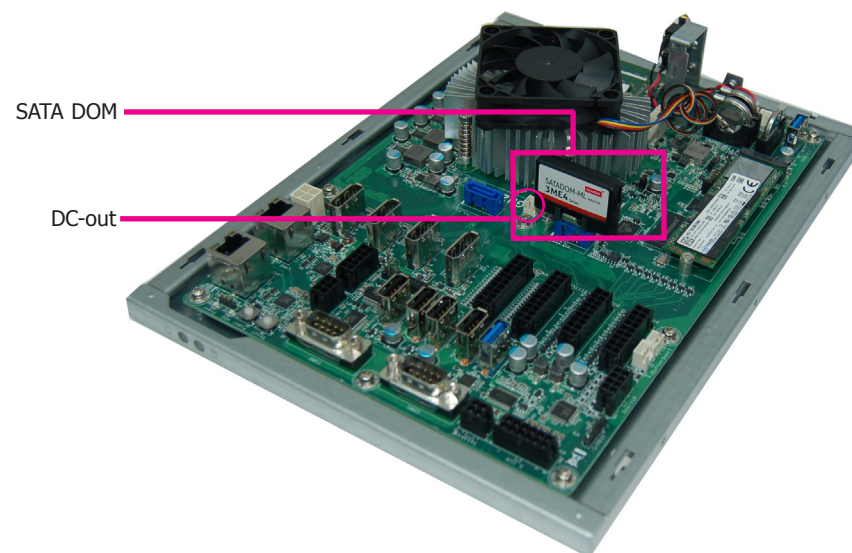

## Chapter 4 - Jumper Settings

### Clear CMOS Data

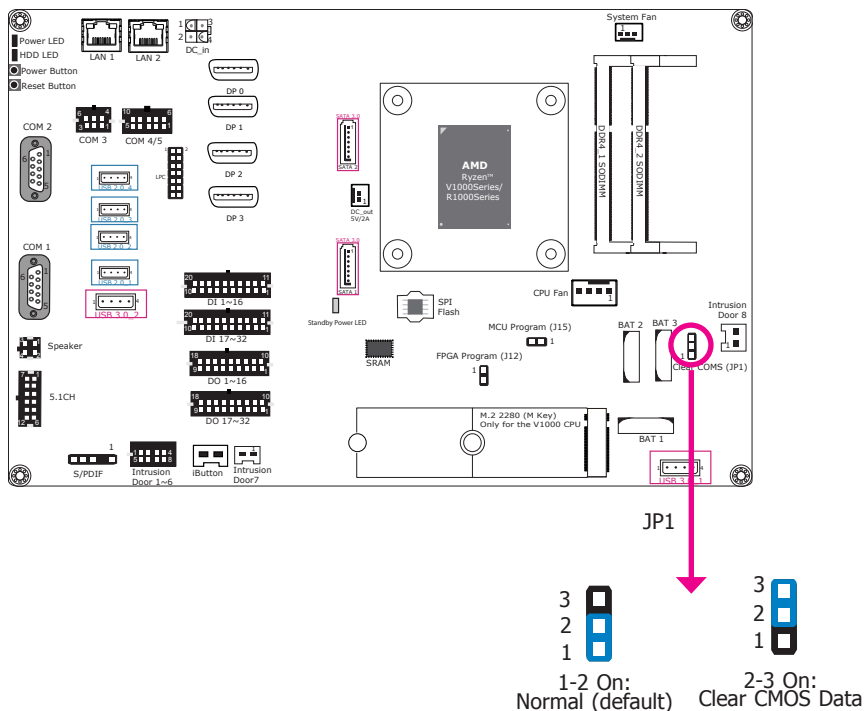

If you encounter the following situations, you can reconfigure the system with the default values stored in the ROM BIOS.

- CMOS data becomes corrupted.
- You forgot the supervisor or user password.

To load the default values stored in the ROM BIOS, please follow the steps below.

- Power-off the system and unplug the power cord.
- Set the jumper pins 2 and 3 to On. Wait for a few seconds and set the jumper back to its default setting, pins 1 and 2 On.
- Now plug the power cord and power-on the system.

### FPGA Programming Mode Select

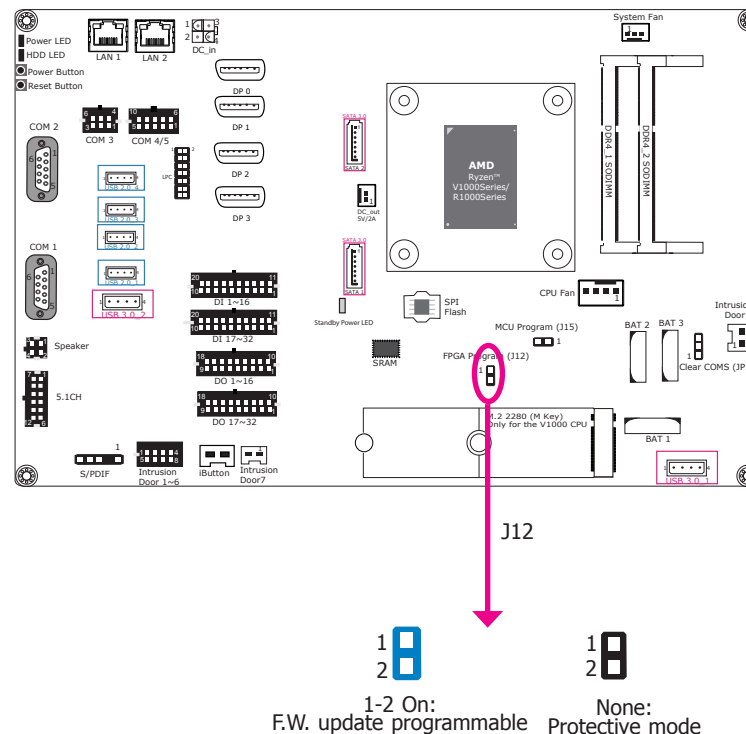

J12 is used to select the FPGA programming mode. To enable or disable FPGA programming of the system board, please set the jumper as indicated above.

## MCU Programming Mode

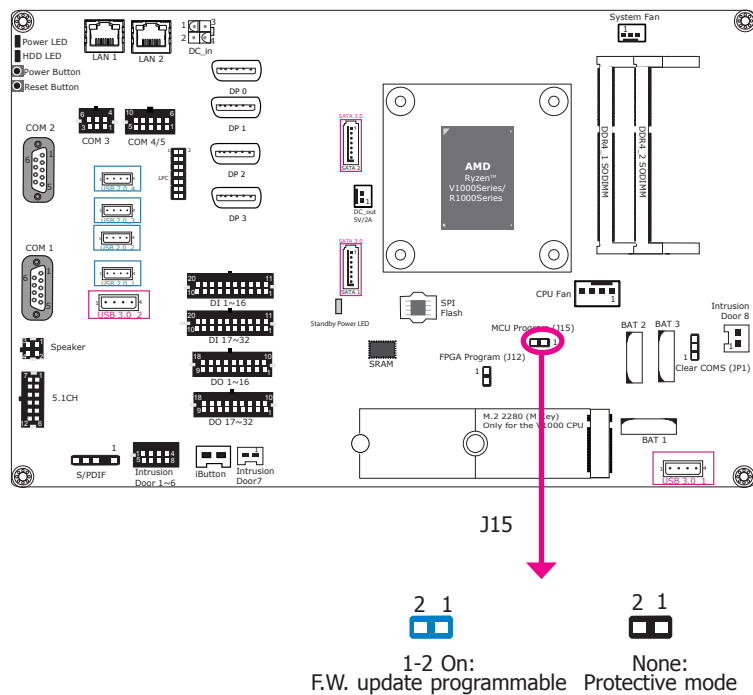

J15 is used to select the MCU programming mode. To enable or disable MCU programming of the system board, please set the jumper as indicated above.

## Chapter 5 - Ports and Connectors

### Audio Ports

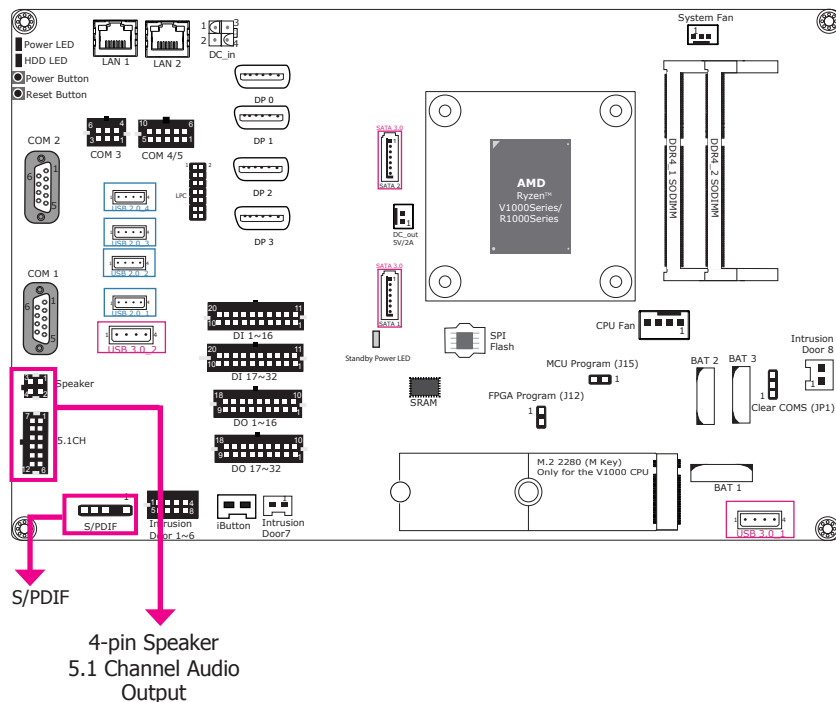

The audio connectors include a 5.1CH audio and a stereo (10W + 10W) speaker output, as well as the digital audio with the S/PDIF connector. These audio ports are provided by Realtek RTL8119 Ethernet Controller and ALC888S High Definition Audio Codec.

#### • BIOS Setting

Configure the audio controller in the "Advanced" menu ("AMD CHIPSET Setting" > "GFX Configuration" > "NB Azalia") of the BIOS. Refer to Chapter 7 for more information.

#### • Driver Installation

You may need to install audio driver in your operating system to use audio devices. Refer to Chapter 8 and your operating system's documentation for more information.

### 5.1 ch Audio

Pins	Pin Assignment	Pins	Pin Assignment
1	LINEOUT-L	7	LINEOUT-R
2	GND	8	GND
3	CENOUT-L	9	LFEOUT-R
4	GND	10	GND
5	SIDEOUT-L	11	SIDEOUT-R
6	GND	12	GND

### S/PDIF

Pins	Pin Assignment
1	+5V
2	Key
3	SPDIF out
4	GND
5	NC

### 4-pin Speaker

Pins	Pin Assignment
1	CH-R+
2	CH-L+
3	CH-R-
4	CH-L-



## USB Ports

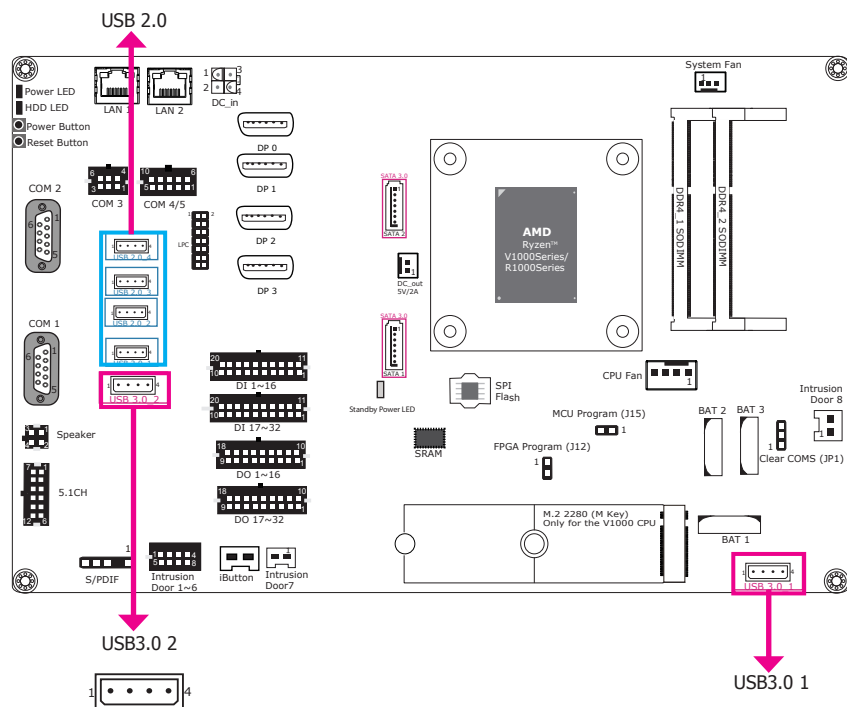

The USB devices allow data exchange between your system and a wide range of simultaneously accessible external Plug and Play peripherals.

The system board is equipped with two USB 3.0 and four USB 2.0 type A vertical ports.

### • BIOS Setting

Configure the COM ports including its communication mode in the "Advanced" menu ("USB Configuration" and "SB USB Configuration" under the "CPU" menu) of the BIOS. Refer to Chapter 7 for more information.

## DC-in

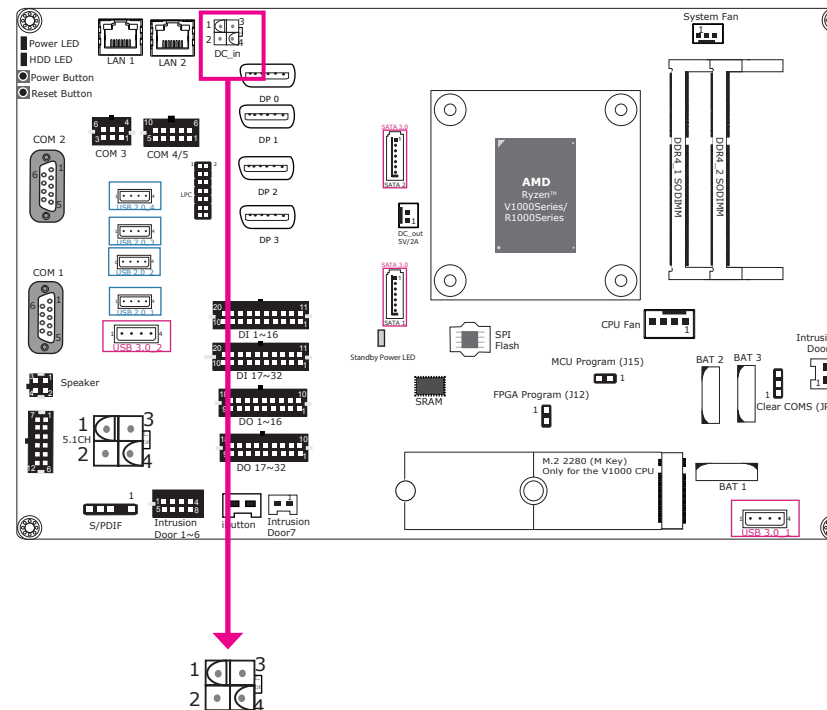

The 4-pin vertical DC-in connector provides a low power input solution. Please use a power adapter with 12V DC output voltage. Using an adapter not compliant to this specification may fail to boot the system or cause damage to the system board.

Pins	Pin Assignment	Pins	Pin Assignment
1	GND 1	3	12V1
2	GND 2	4	12V2

## COM Ports

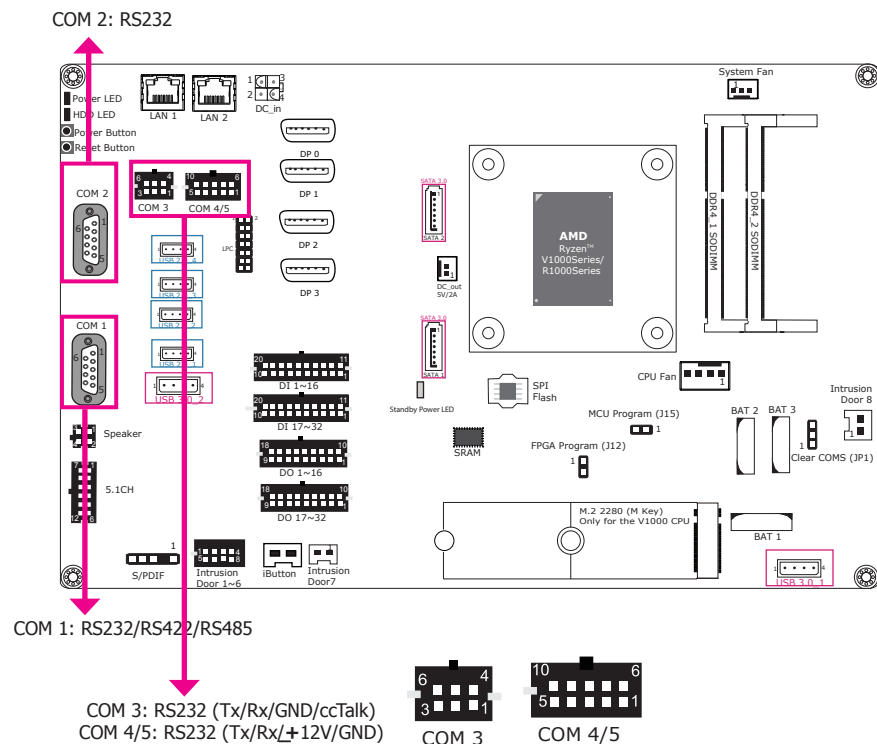

COM 1 and COM 3 can be selected among different communication mode whereas COM 2 can be used in RS232 mode only. COM 3 and COM 4/5 are pin headers and provide signals that are different from typical RS232 communication.

### Serial Port

The serial port is an asynchronous communication ports that can be used with modems, serial printers, remote display terminals, and other serial devices. And the ccTalk protocol of COM 3 can be used to connect peripherals used in automatic payment machines for a variety of market sectors such as transportation, ticketing, gaming and entertainment, and retail. In addition, through the console redirection function of the BIOS (COM 1 and COM 2), you can monitor and control the system from a remote station.

### • BIOS Setting

Configure the COM ports including its communication mode in the "Advanced" menu ("NCT6116D Super IO Configuration" submenu) and ("Serial Port Console Redirection" submenu) of the BIOS. Refer to Chapter 7 for more information.

### COM 1 (RS232/RS422/RS485) / COM 2 (RS232)

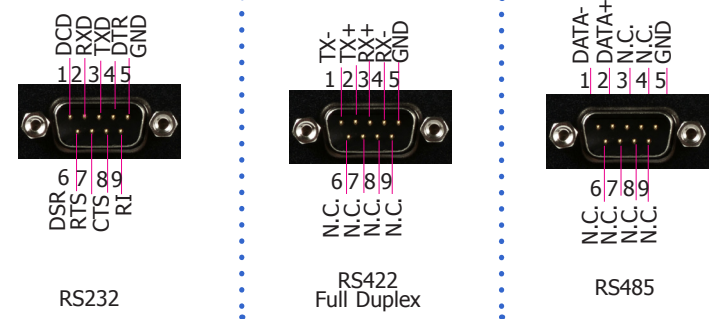

### COM 3: RS232 (TX/RX/GND/ccTalk)

Pins	Pin Assignment
1	COM3 RS232-TX
2	COM3 RS232-RX
3	GND
4	+12V power out
5	ccTalk
6	GND

### COM 4/5: RS232 (Tx/Rx/+12V/GND)

Pins	Pin Assignment
1	COM4 RS232-TX
2	COM4 RS232-RX
3	+12V power out
4	-12V power out
5	GND
6	COM5 RS232-TX
7	COM5 RS232-RX
8	+12V power out
9	-12V power out
10	GND

## RJ45 LAN Ports

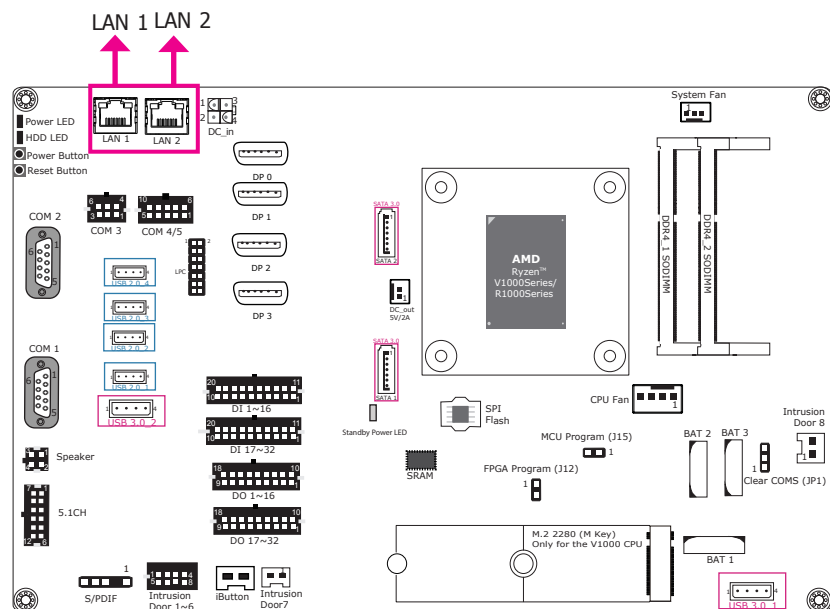

### Features

- 2 Realtek® RTL8119 or RTL8111HN Gigabit Ethernet Controller

The LAN ports provide WOL (Wake On LAN) and PXE (Preboot eXecution Environment) functions and these functions can be configured in the BIOS.

### BIOS Setting

Configure the onboard LAN in the “Advanced” menu (“ACPI Configuration” and “Network Stack Configuration” submenus) of the BIOS. Refer to Chapter 7 for more information.

### Driver Installation

Install the LAN drivers. Refer to Chapter 8 for more information.

## Intrusion Doors

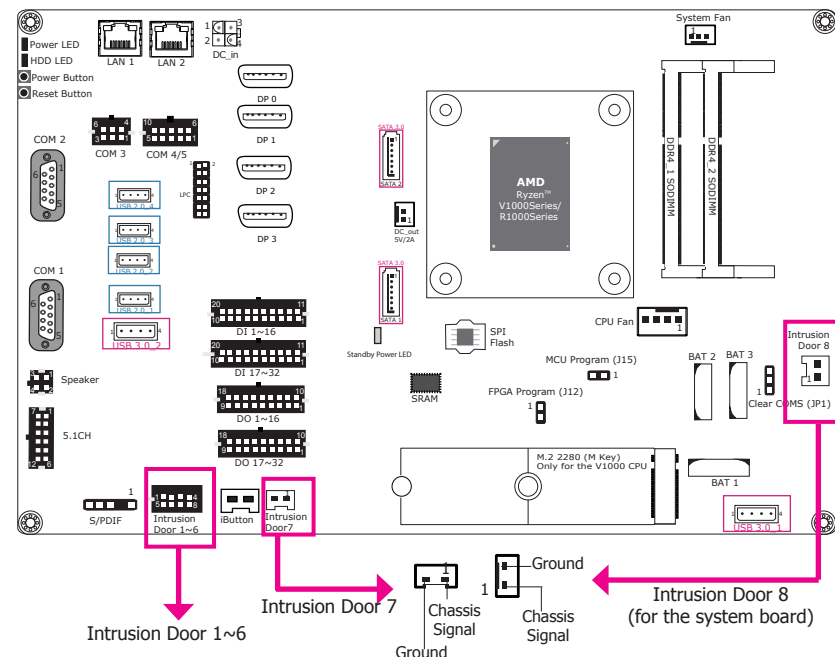

Pins	Pin Assignment	Pins	Pin Assignment
1	Door 1	5	Door 5
2	Door 2	6	Door 6
3	Door 3	7	GND
4	Door 4	8	GND

This intrusion door connector provides 6 pins plus two additional intrusion door connectors for detecting chassis intrusion events. The demonstration application can display logged events and the API utility provides logging functions for recording up to a total of 64 entries.

### Software

The software package that came with the system contains application and code samples to implement door intrusion alarms for the system.

## Display Outputs

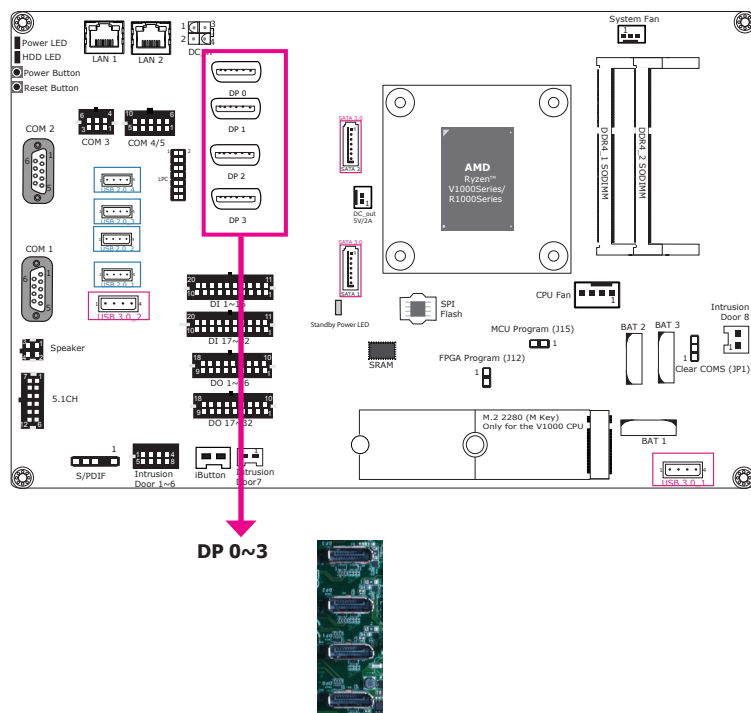

## Digital Inputs/Outputs

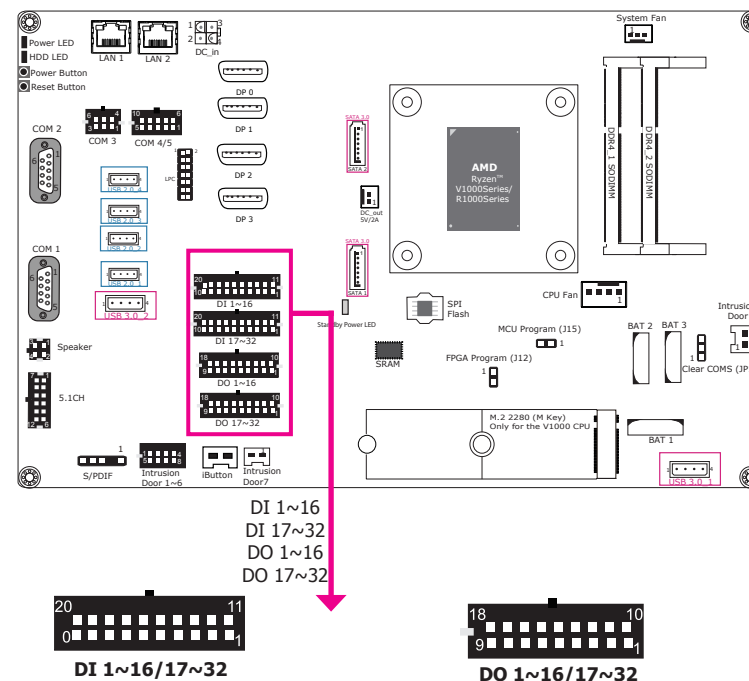

The DisplayPort, a digital display interface, is provided by the integrated AMD® Radeon™ Vega graphics and can be connected to LCD monitors. These ports support resolution up to 4096x2160. Note that the AMD® Ryzen™ V1000 series processors provide 4 DP++ ports whereas the R1000 series processors provide 3 DP++ ports.

### BIOS Setting

Configure the graphics device in the “Advanced” menu (“AMD CHIPSET Setting” > “GFX Configuration”) of the BIOS. Refer to Chapter 7 for more information.

### Driver Installation

Install the AMD® Radeon™ graphics driver and software. Please refer to Chapter 8 for more information.

### Digital Input 1~16/17~32

Pins	Pin Assignment	Pins	Pin Assignment
1	DI 1 / DI 17	11	DI 11 / DI 27
2	DI 2 / DI 18	12	DI 12 / DI 28
3	DI 3 / DI 19	13	DI 13 / DI 29
4	DI 4 / DI 20	14	DI 14 / DI 30
5	DI 5 / DI 21	15	DI 15 / DI 31
6	DI 6 / DI 22	16	DI 16 / DI 32
7	DI 7 / DI 23	17	GND
8	DI 8 / DI 24	18	GND
9	DI 9 / DI 25	19	GND
10	DI 10 / DI 26	20	GND

### Digital Output 1~16/17~32

Pins	Pin Assignment	Pins	Pin Assignment
1	DO 1 / DO 17	11	DO 10 / DO 26
2	DO 2 / DO 18	12	DO 11 / DO 27
3	DO 3 / DO 19	13	DO 12 / DO 28
4	DO 4 / DO 20	14	DO 13 / DO 29
5	DO 5 / DO 21	15	DO 14 / DO 30
6	DO 6 / DO 22	16	DO 15 / DO 31
7	DO 7 / DO 23	17	DO 16 / DO 32
8	DO 8 / DO 24	18	GND
9	DO 9 / DO 25	19	GND

The Digital I/O connector provides 32-bit digital inputs or outputs to enable monitor and control of the states of the connected external devices. The recommended application voltage range is from 0 V to 24 V.

The digital I/O ports support Electrostatic discharge (ESD) protection to prevent damage from ESD strikes between two connected devices. The following are detailed features:

- Protects one data or I/O line
- Max. peak pulse power: 160W at  $t_p = 8/20$  us.
- Low clamping voltage
- IEC 61000-4-2, level 4 (ESD),  $>+_{15KV}$  (air);  $>+_{8KV}$  (contact)

### Software

The system comes with a demonstration program and an API utility, allowing you to control digital I/O pins. The GPIO Control API of the GamingLogic API utility allows you to control the digital input/output pins. Please contact your sales representative for the gaming software package.

### Driver Installation

Install the Windows WinDriver. Please refer to Chapter 8 for more information.

## Expansion Connectors

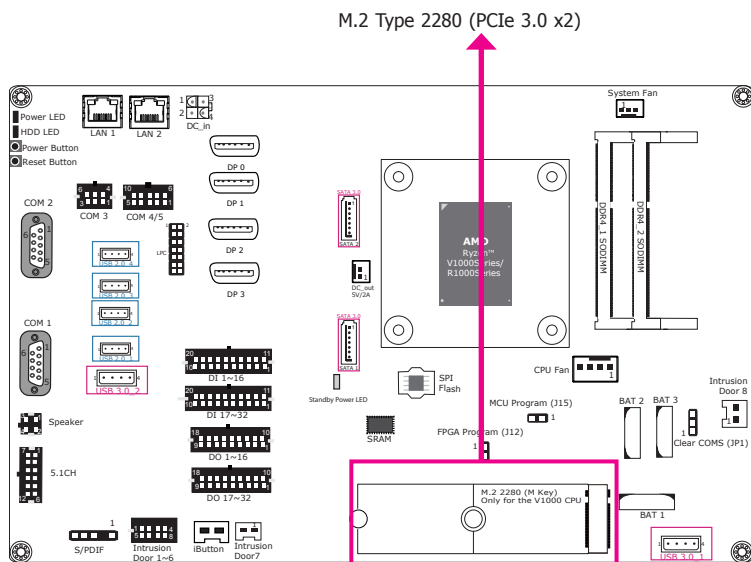

### M.2 M Key slot (only with the AMD® Ryzen™ V1000 series processors)

The M.2 type 2280 card slot (M Key) supports PCIe NVMe 3.0 x2 interface to accommodate NVMe SSDs. It can be inserted with an M.2 (NGFF) card with the form factor of 22x80 mm.

## CPU/System Fan Connector

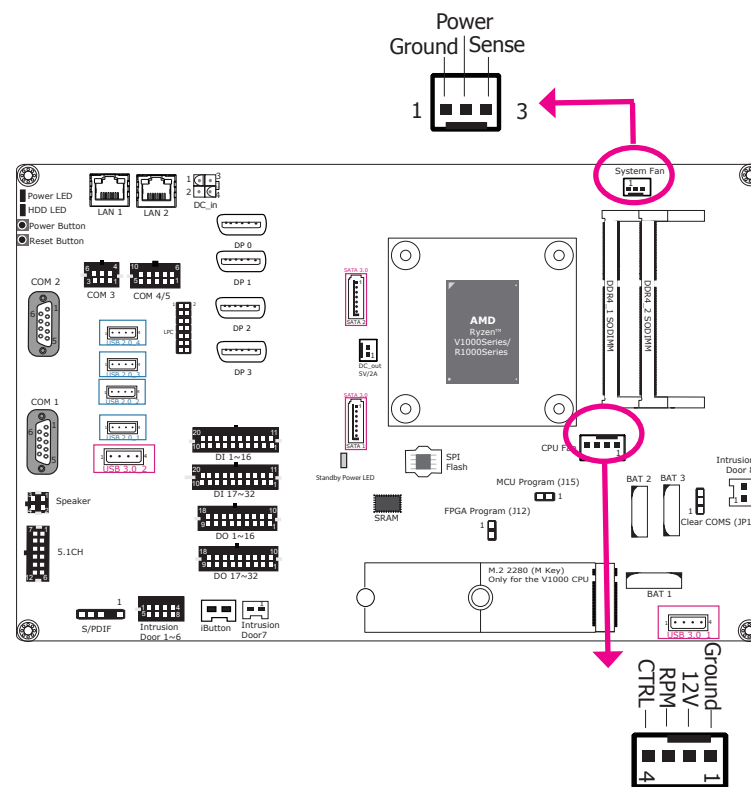

The fan connector is used to connect cooling fan. The cooling fan will provide adequate airflow throughout the chassis to prevent overheating the CPU and system board components.

### BIOS Setting

The Advanced menu ("NCT6116D HW Monitor" submenu) of the BIOS will display the current speed of the cooling fans. Refer to the Chapter 7 for more information.

## LEDs

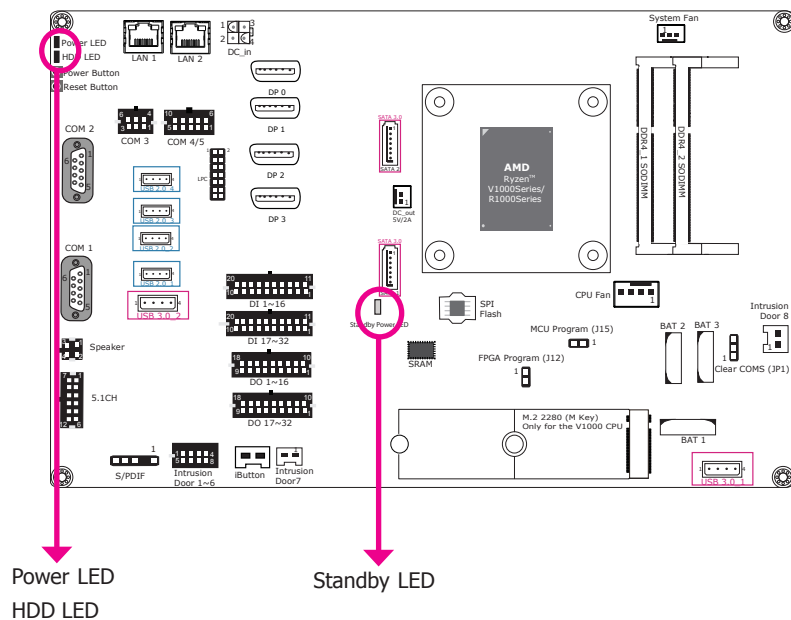

### Power LED (green)

This LED will be green when the system is powered on.

### HDD LED (flashing orange)

The HDD LED will flash orange when storage devices are being accessed.

### Standby LED

This LED will be red when there is power on the system board.

## Battery

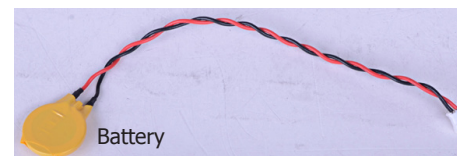
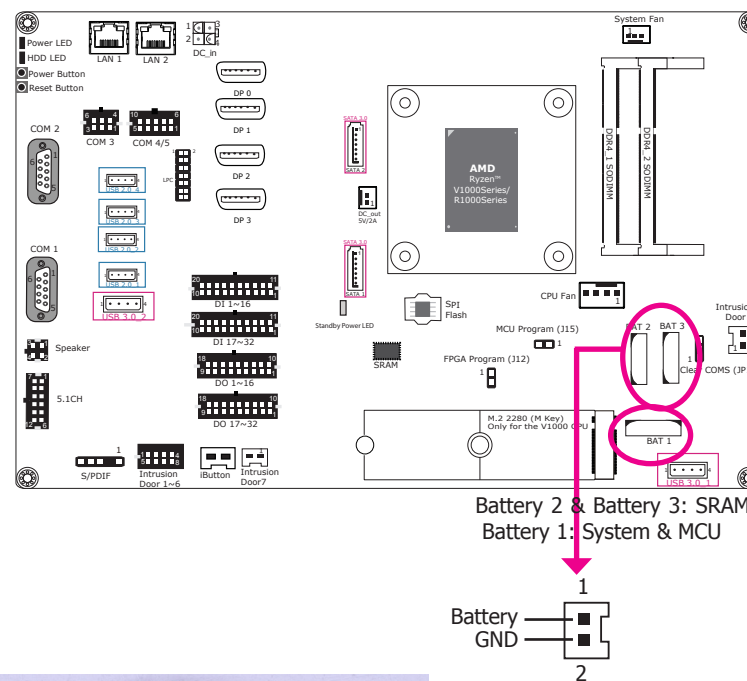

Connect to the battery connector

The lithium-ion battery is an auxiliary source of power when the main power is shut off. Two of them provide power for the Static Random-Access Memories (BAT 2 & 3) and one provides power for the MCU and the system's CMOS memory (BAT 1). The batteries for SRAM enables the system to retain data for 5 years without AC power supply. The demonstration application can show the voltage readings as well as set threshold values and its API utility provides functions for battery voltage monitoring.

### Safety Measures

- Danger of explosion if battery is incorrectly replaced.
- Replace only with the same or equivalent type recommend by the manufacturer.
- Dispose of used batteries according to local ordinance.

### Software

The software package that came with the system contains application and code samples to implement voltage monitoring and alarms for the system.

## SATA (Serial ATA) Connectors

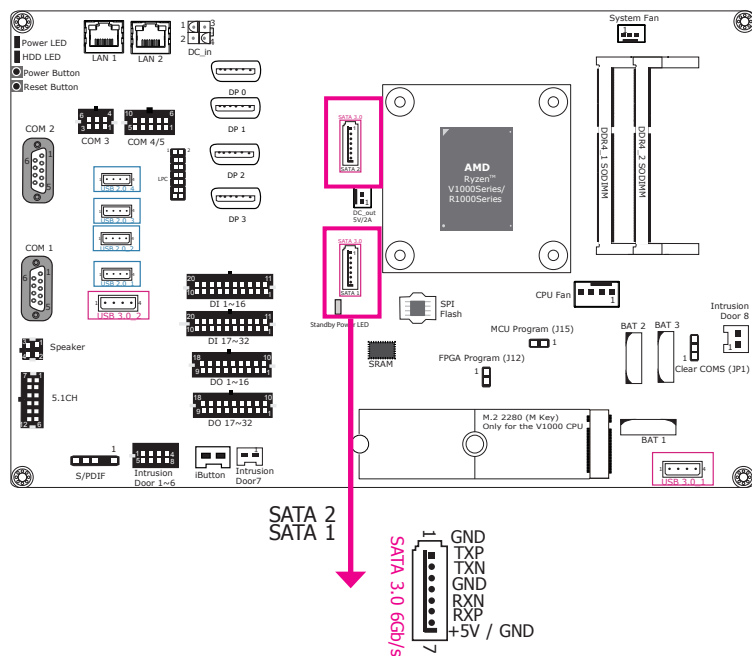

### Features

- 2 Serial ATA 3.0 ports
  - SATA port 1 and 2 with data transfer rate up to 6Gb/s
- Pin 7 provides +5V power and can switch between +5V and GND automatically

The Serial ATA connectors are used to connect the Serial ATA devices such as a Serial ATA Disk on Module (SATA DOM).

### BIOS Setting

Configure the Serial ATA drives in the Advanced menu ("AMD CHIPSET Setting" > "SATA Configuration Options") of the BIOS. Refer to Chapter 7 for more information.

## LPC Connector

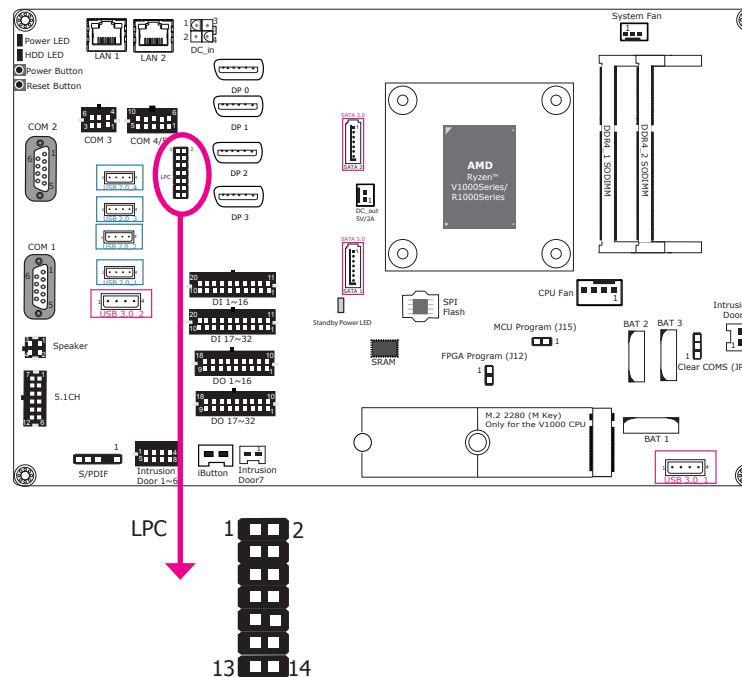

The Low Pin Count Interface was defined by Intel® Corporation to facilitate the industry's transition towards legacy free systems. It allows the integration of low-bandwidth legacy I/O components within the system, which are typically provided by a Super I/O controller. Furthermore, it can be used to interface firmware hubs, Trusted Platform Module (TPM) devices and embedded controllers. Data transfer on the LPC bus is implemented over a 4 bit serialized data interface, which uses a 24MHz LPC bus clock. For more information about LPC bus, please refer to the Intel® Low Pin Count Interface Specification Revision 1.1'. The table below indicates the pin functions of the LPC connector.

Pin	Pin Assignment	Pin	Pin Assignment
1	L_CLK	2	L_AD1
3	L_RST#	4	L_AD0
5	L_FRAME#	6	3V3
7	L_AD3	8	GND
9	L_AD2	10	Key
11	INT_SERIRQ	12	GND
13	5VSB	14	5V



## 5V DC-out

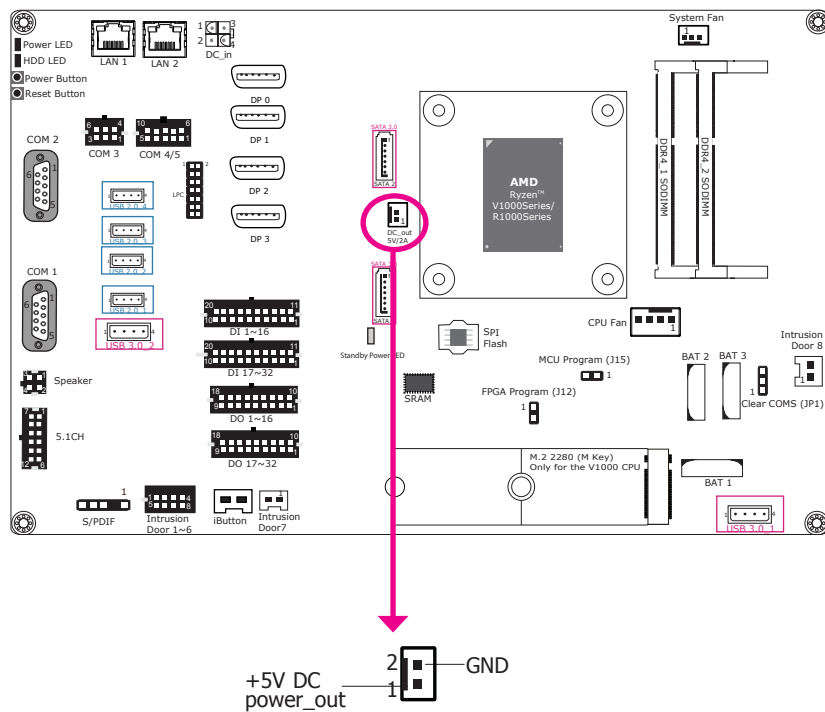

The 2-pin connector provides low power output of 5V/2A.

## Chapter 6 - Mounting

**Note:**

The system unit used in the following illustrations may not resemble the actual one. These illustrations are for reference only.

### Wall Mount

The system has screw holes on the bottom of the chassis to support wall mount.

1. Drill 4 holes in the wall and insert screw bolts into the holes.
2. Drill the screws into the screw anchors.
3. Hang the device on the wall.

The diagram on the right shows the screw holes and dimensions of wall mount (in millimeter).

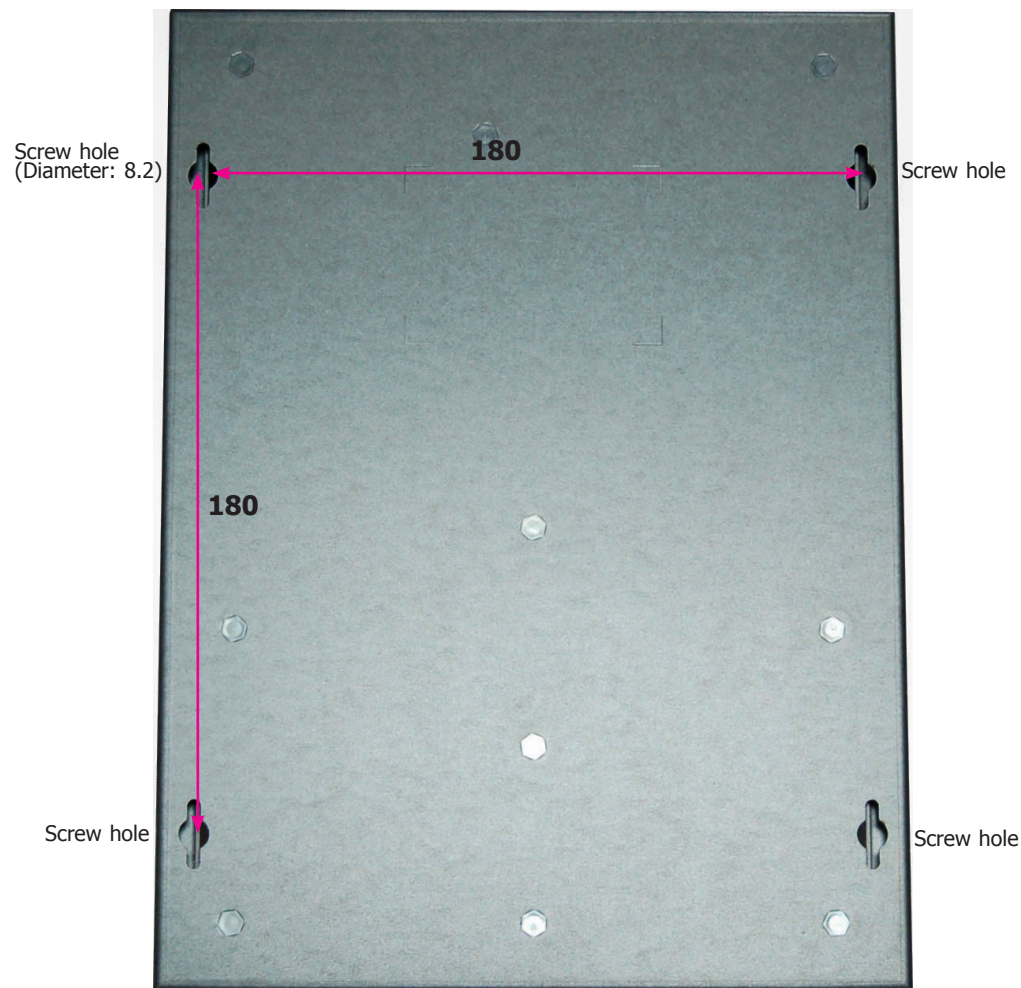

## Chapter 7 - BIOS Setup

### Overview

The BIOS is a program that takes care of the basic level of communication between the CPU and peripherals. It contains codes for various advanced features found in this system board. The BIOS allows you to configure the system and save the configuration in a battery-backed CMOS so that the data retains even when the power is off. In general, the information stored in the CMOS RAM of the EEPROM will stay unchanged unless a configuration change has been made such as a hard drive replaced or a device added.

It is possible that the CMOS battery will fail causing CMOS data loss. If this happens, you need to install a new CMOS battery and reconfigure the BIOS settings.



#### Note:

The BIOS is constantly updated to improve the performance of the system board; therefore the BIOS screens in this chapter may not appear the same as the actual one. These screens are for reference purpose only.

### Default Configuration

Most of the configuration settings are either predefined according to the Load Optimal Defaults settings which are stored in the BIOS or are automatically detected and configured without requiring any actions. There are a few settings that you may need to change depending on your system configuration.

### Entering the BIOS Setup Utility

The BIOS Setup Utility can only be operated from the keyboard and all commands are keyboard commands. The commands are available at the right side of each setup screen.

The BIOS Setup Utility does not require an operating system to run. After you power up the system, the BIOS message appears on the screen and the memory count begins. After the memory test, the message "Press DEL to run setup" will appear on the screen. If the message disappears before you respond, restart the system or press the "Reset" button. You may also restart the system by pressing the <Ctrl> <Alt> and <Del> keys simultaneously.

### Legends

Keys	Function
Right and Left arrows	Moves the highlight left or right to select a menu.
Up and Down arrows	Moves the highlight up or down between submenu or fields.
<Esc>	Exit to the BIOS Setup Utility.
+ (plus key)	Scrolls forward through the values or options of the highlighted field.
- (minus key)	Scrolls backward through the values or options of the highlighted field.
<F1>	Displays general help
<F2>	Pervious values
<F9>	Optimized defaults
<F10>	Saves and resets the setup program.
<Enter>	Press <Enter> to enter the highlighted submenu.

### Scroll Bar

When a scroll bar appears to the right of the setup screen, it indicates that there are more available fields not shown on the screen. Use the up and down arrow keys to scroll through all the available fields.

### Submenu

When "►" appears on the left of a particular field, it indicates that a submenu which contains additional options are available for that field. To display the submenu, move the highlight to that field and press <Enter>.

## AMI BIOS Setup Utility

### Main

The Main menu is the first screen that you will see when you enter the BIOS Setup Utility.

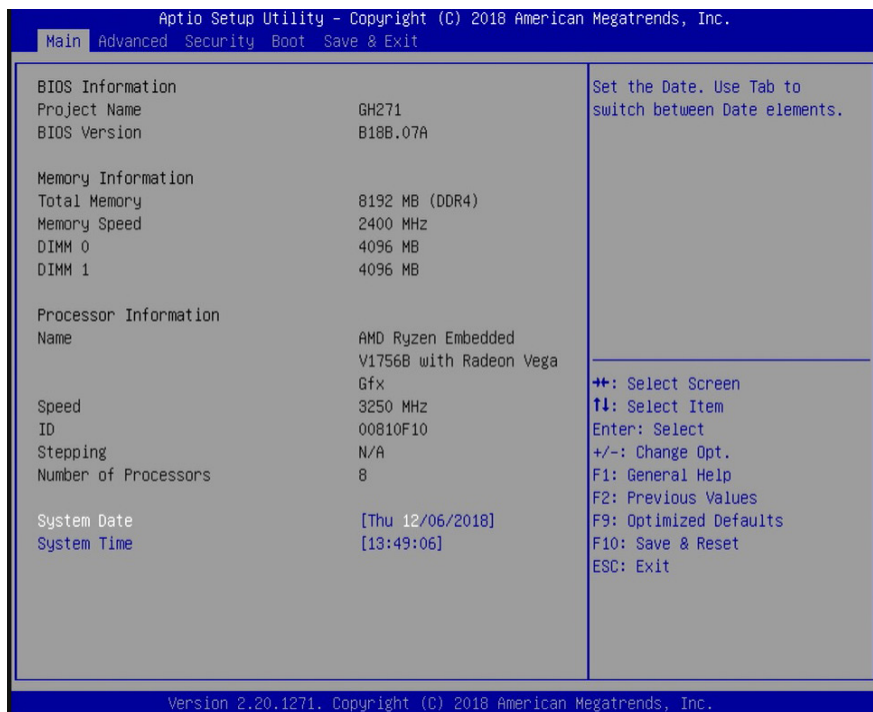

#### System Date

The date format is <day>, <month>, <date>, <year>. Day displays a day, from Sunday to Saturday. Month displays the month, from January to December. Date displays the date, from 1 to 31. Year displays the year, from 1980 to 2099.

#### System Time

The time format is <hour>, <minute>, <second>. The time is based on the 24-hour military-time clock. For example, 1 p.m. is 13:00:00. Hour displays hours from 00 to 23. Minute displays minutes from 00 to 59. Second displays seconds from 00 to 59.

## Advanced

The Advanced menu allows you to configure your system for basic operation. Some entries are defaults required by the system board, while others, if enabled, will improve the performance of your system or let you set some features according to your preference.



#### Important:

Setting incorrect field values may cause the system to malfunction.

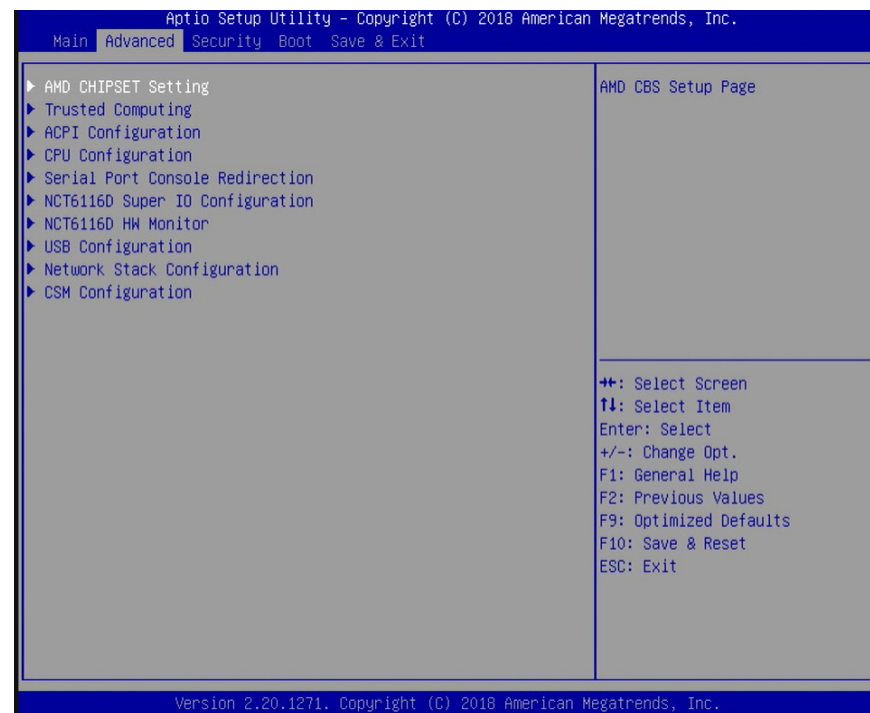

## AMD CHIPSET Setting

This section configures the parameters of the AMD chipset.



### DRAM ECC Enable

Enable or disable the support for ECC memory.

## GFX Configuration

This section configures the parameters of the integrated graphics.

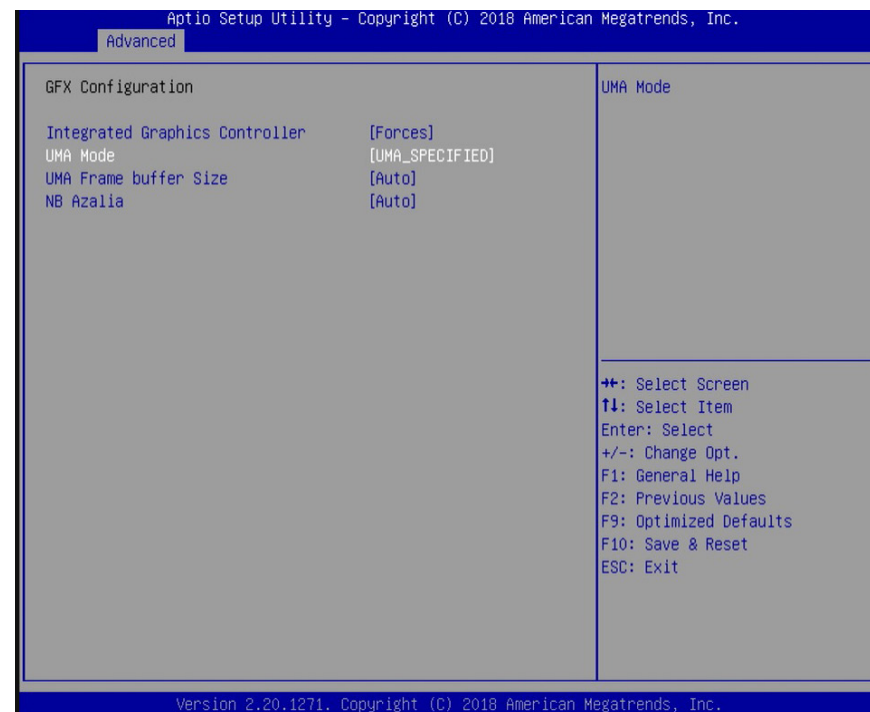

### Integrated Graphics Controller

Configure the integrated graphics controller with these options: Disabled, Forces, or Auto.

### UMA Mode

This option only appears if the Integrated Graphics Controller is set to Forces. Select the UMA (Unified Memory Architecture) mode from these options: Auto or UMA\_SPECIFIED.

### UMA Frame buffer Size

This option only appears if you choose to specify the UMA mode. Configure the UMA frame buffer size with these options: Auto, 64M, 128M, 256M, 384M, 512M, 1G, or 2G.

### NB Azalia

Automatically configure the integrated high-definition audio controller or disable it.

### SATA Configuration Options

This section configures the parameters of the SATA controller.

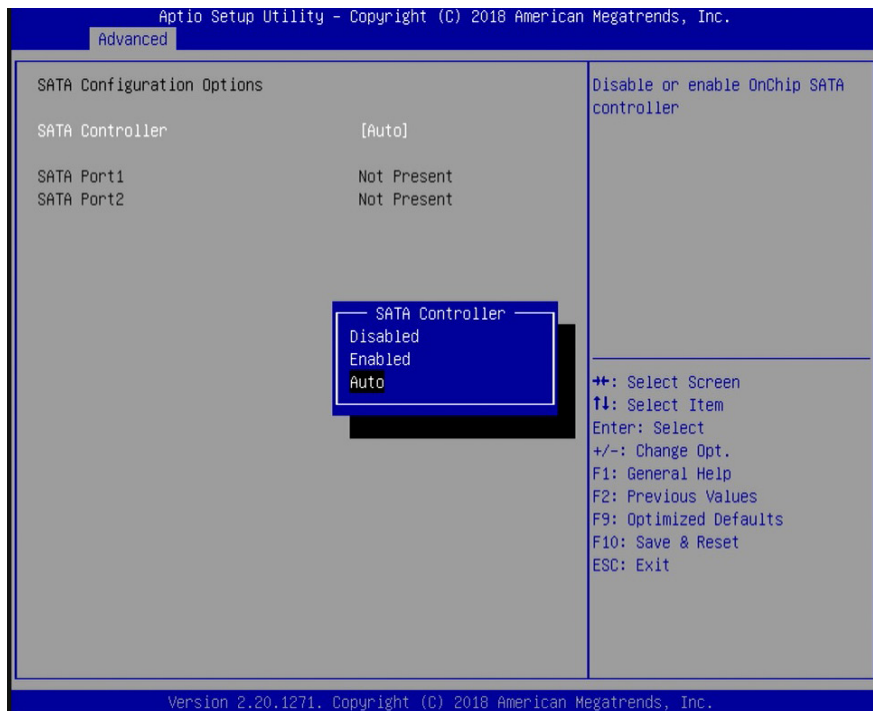

#### SATA Controller

Enable, disable or automatically configure the SATA controller.

#### SATA Port 1

Enable or disable each SATA port.

### SB USB Configuration

This section configures the parameters of the USB controller.

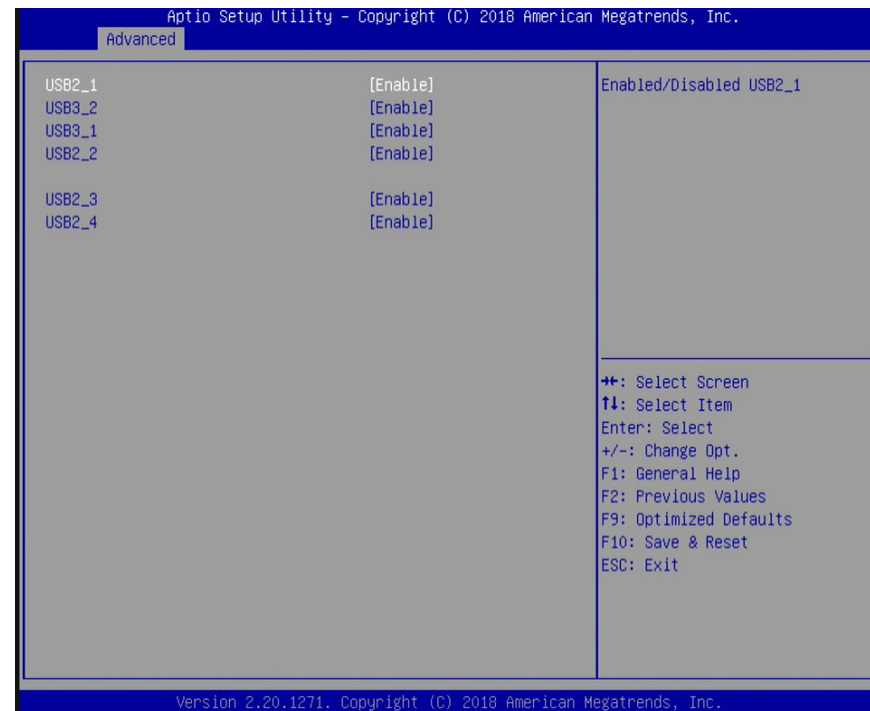

#### USB2\_1 USB2\_2 USB2\_3 USB2\_4

Enable or disable each USB 2.0 port.

#### USB3\_1 USB3\_2

Enable or disable each USB 3.0 port.

## Trusted Computing

This section configures security settings.

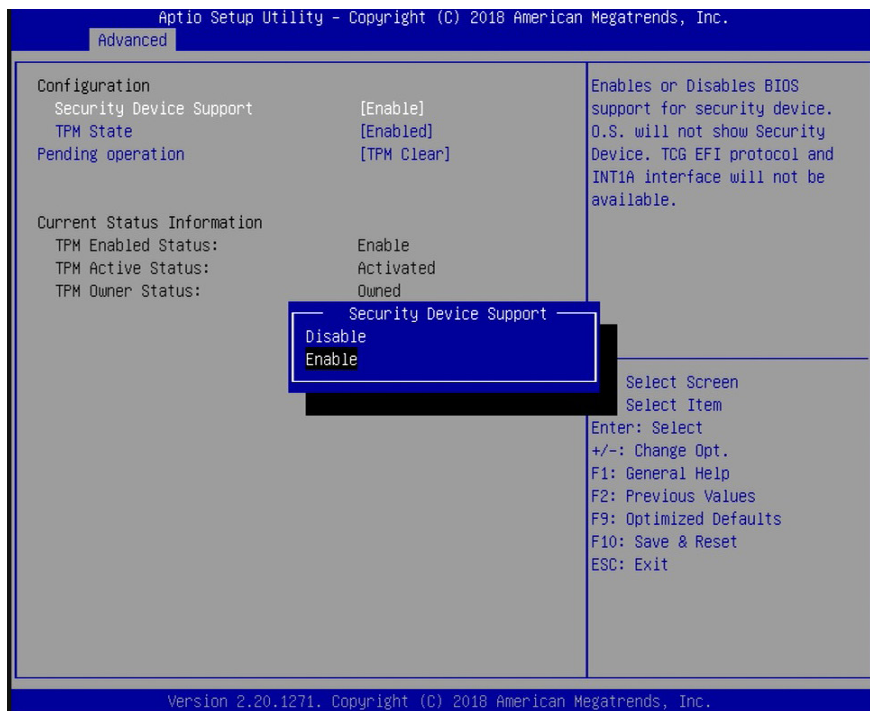

### Security Device Support

Enable or disable the support for Trusted Platform Module (TPM) and allow the BIOS to automatically download the drivers needed to activate this function. After you have enabled this function, you can change the TPM state which allows different TPM operations.

#### TPM State

Enable or disable the TPM State.

#### Pending Operation

Schedule an operation for the security device.

## ACPI Configuration

This section configures system ACPI parameters.

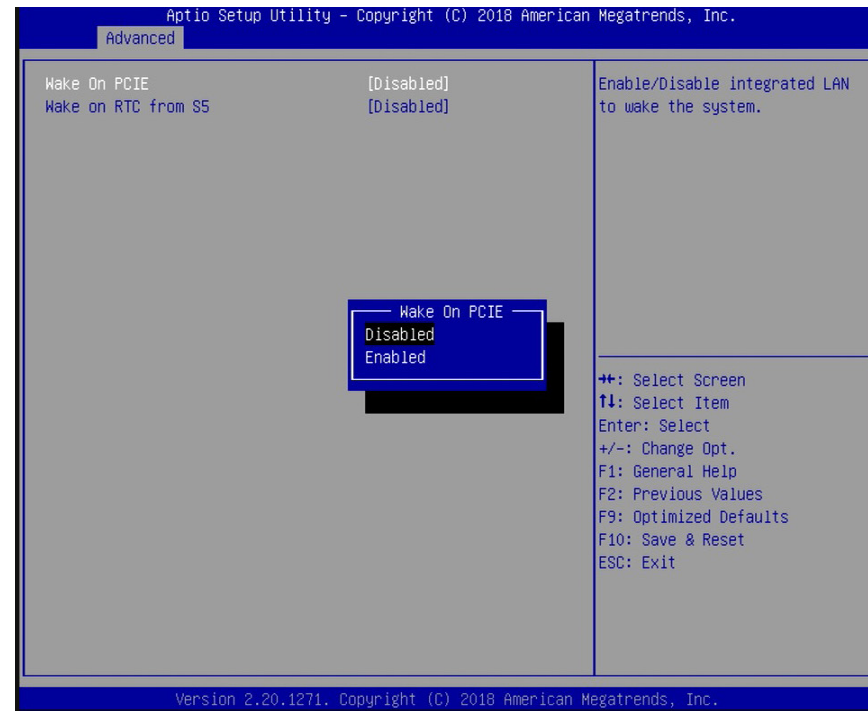

### Wake on PCIE

Enable or disable automatic system wake-up using the integrated LAN.

### Wake on RTC from S5

Enable or disable the resume on RTC alarm function, which automatically powers on the system from S5 power state (soft-off state) at the specified time every day.

**Wake up hour** Input any value between 0 and 23.

**Wake up minute** Input any value between 0 and 59.

**Wake up second** Input any value between 0 and 59.

### CPU Configuration

This section configures the CPU.

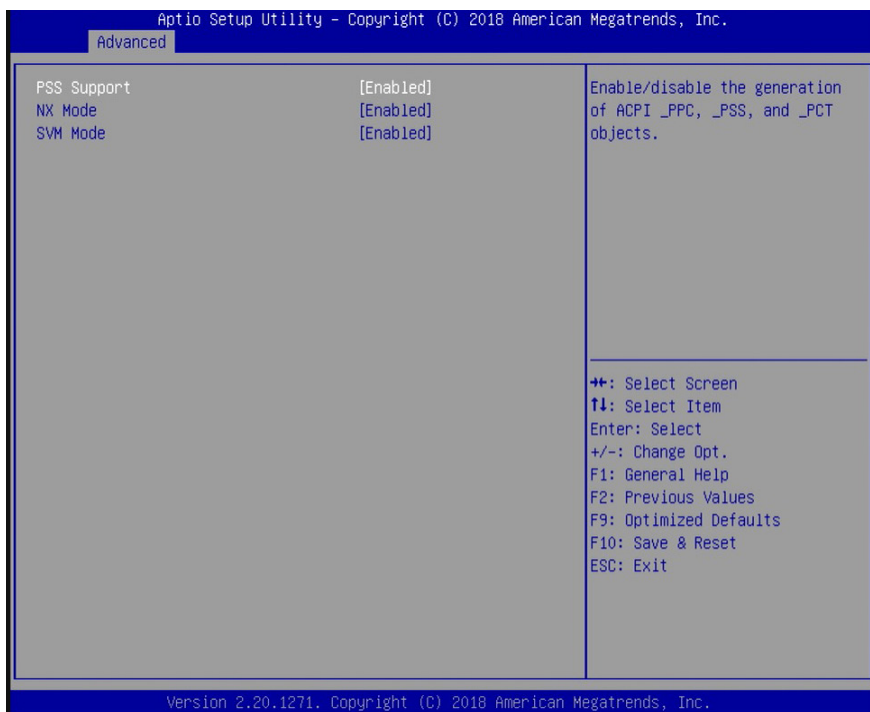

#### PSS Support

Enable or disable the generation of ACPI PPC, PSS, and PCT objects. These objects are associated with the operation of CPU P-state.

#### NX Mode

Enable or disable the non-execute page protection function.

#### SVM Mode

Enable or disable the CPU virtualization function.

### Serial Port Console Redirection

Console redirection lets you monitor and control the system from a remote station by re-directing the host screen output through a serial port.

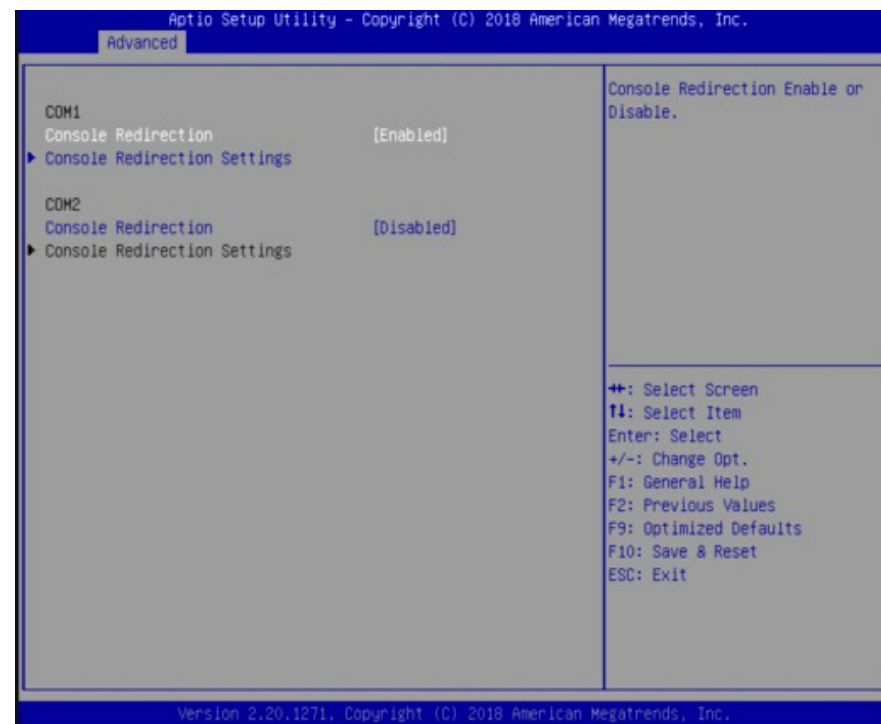



**NCT6116D Super IO Configuration**

This section configures the system super I/O chip parameters.

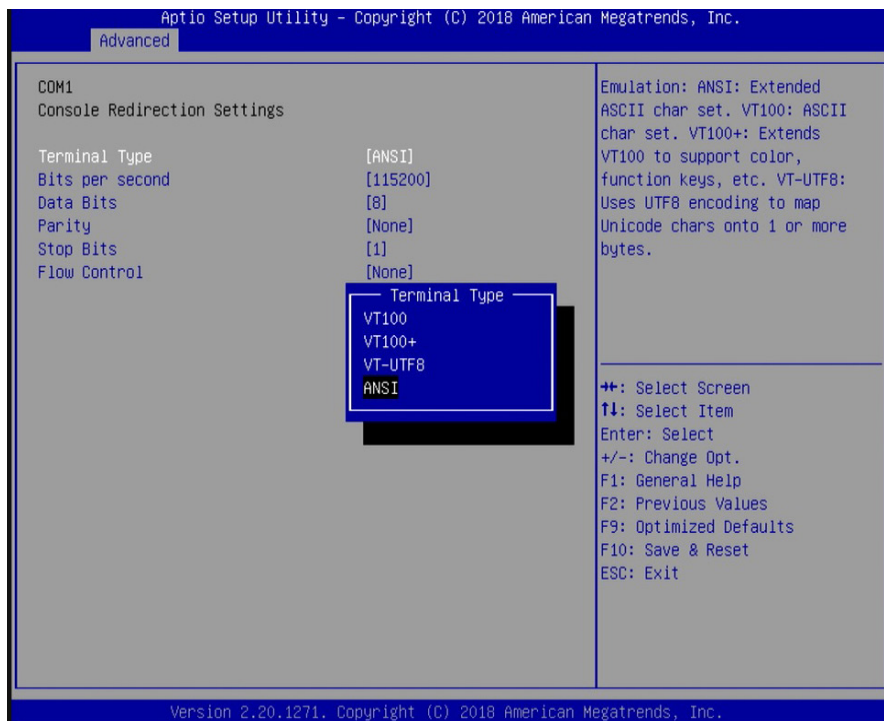
**Console Redirection Settings**

Enable or disable the console redirection function. (The default is disabled.) If you select to enable it, please configure the following parameters for serial communication between the system and a remote station:

Terminal type: VT100, VT100+, VT-UTF8, or ANSI.

Bits per second: 115200, 57600, 38400, 19200 or 9600.

Data bits: 8 bits or 7 bits.

Parity: None, Even or Odd.

Stop bits: 1 bit or 2 bits.

Flow control: None or Hardware RTS/CTS.

**WatchDog Timer Unit  
SuperIO WatchDog Timer**

Enable or disable the watchdog function. A counter will appear if you select to enable the WDT. Input any value between 1 to 255 in the "SuperIO WatchDog Timer" field.

**NCT6116D HW Monitor**

This section displays the hardware health status.

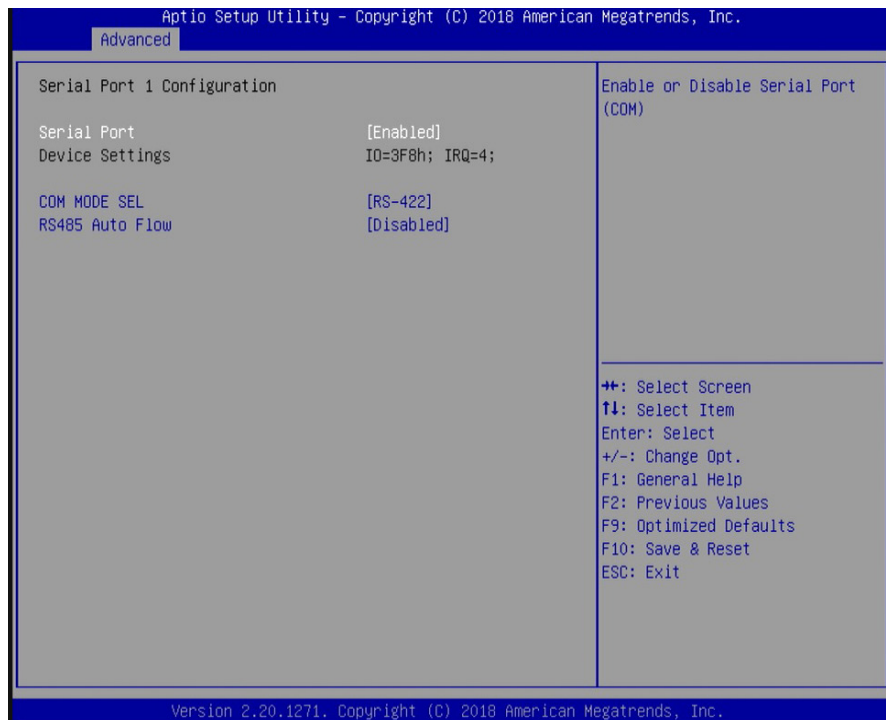
**Serial Port 1 to 5**

Enable or disable the serial port (COM).

**Device Settings**

It shows the IO/IRQ settings for the super I/O device.

**COM MODE SEL** (only available for Serial Port 1 and 3)

Configure the serial port mode. The settings are RS232, RS422 and RS485 for Serial Port 1, and RS232 and CC-TALK for Serial Port 3.

**RS485 Auto Flow**

Enable or disable the auto flow mechanism for COM Port 1.

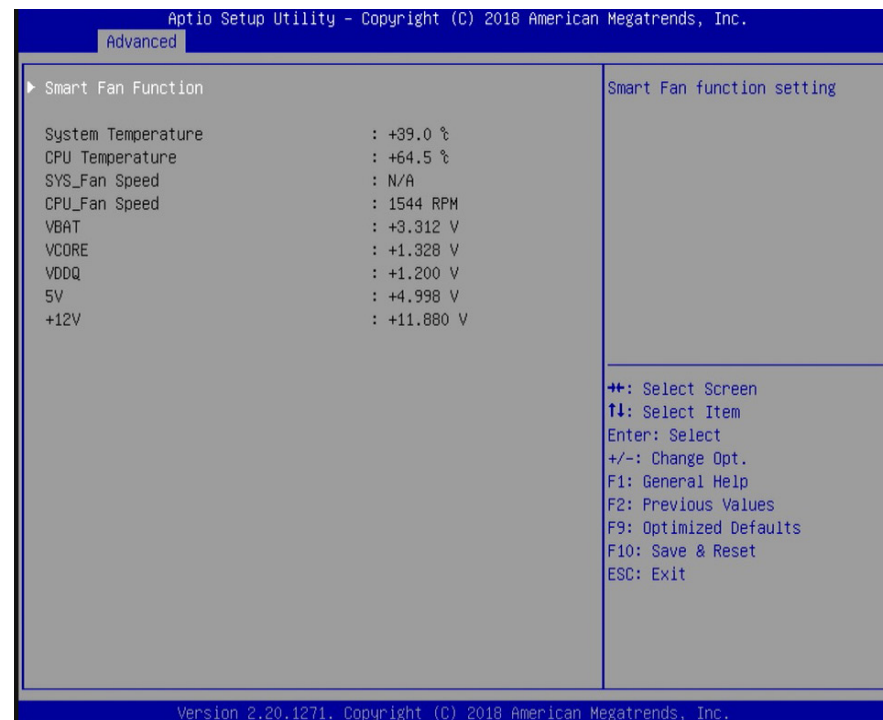

## USB Configuration

This section configures the parameters of USB devices.

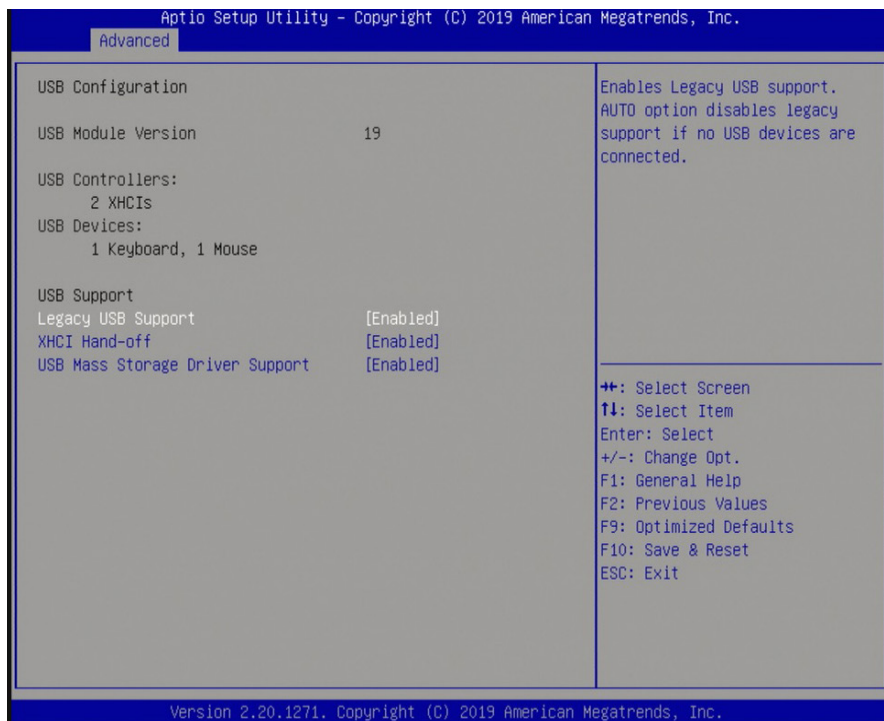

### Legacy USB Support

#### Enabled

Enables legacy USB.

#### Disabled

Keeps USB devices available only for EFI applications.

### XHCI Hand-off

This is a workaround for OSeS that do not support eXtensible Host Controller Interface (xHCI) hand-off. The xHCI ownership change should be claimed by the xHCI driver.

### USB Mass Storage Driver Support

Enable or disable the support for the USB Mass Storage Driver.

## Network Stack Configuration

This section enables or disables network stack settings.



When "Network Stack" is set to enabled, it displays the following configuration settings:

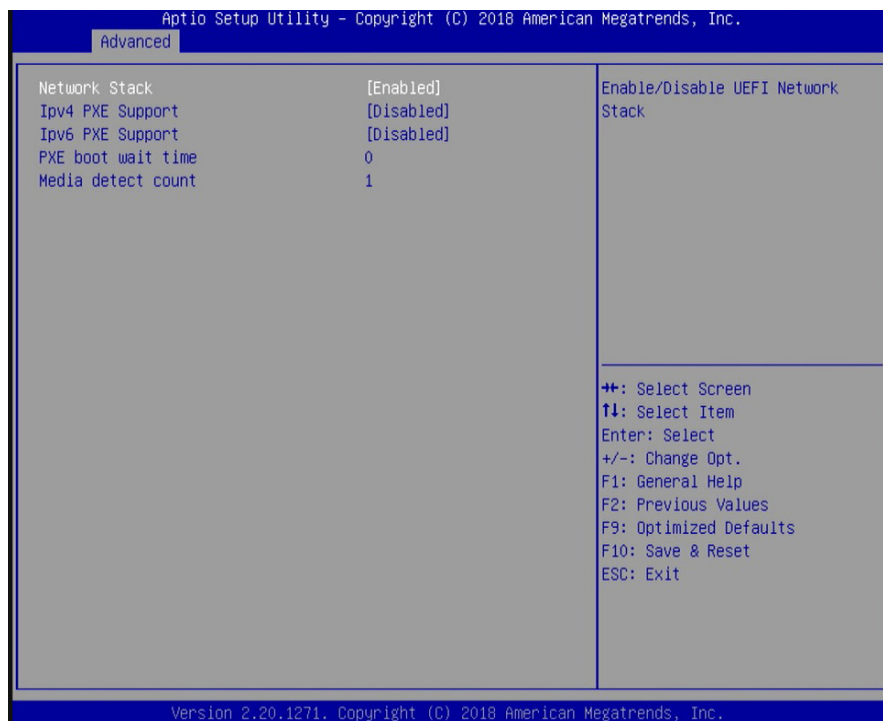

#### IPv4 PXE Support

Enable or disable Preboot eXecution Environment (PXE) boot to LAN using IPv4 addressing architecture.

#### IPv6 PXE Support

Enable or disable Preboot eXecution Environment (PXE) boot to LAN using IPv6 addressing architecture.

#### PXE boot wait time

Enter the wait time value (seconds) to abort the PXE boot by pressing the ESC key. Valid range is from 0 to 5 seconds.

#### Media detect count

Enter the number of times the presence of media will be checked. Valid range is from 1 to 50 times.

### CSM Configuration

This section configures Compatibility Support Module (CSM) settings.

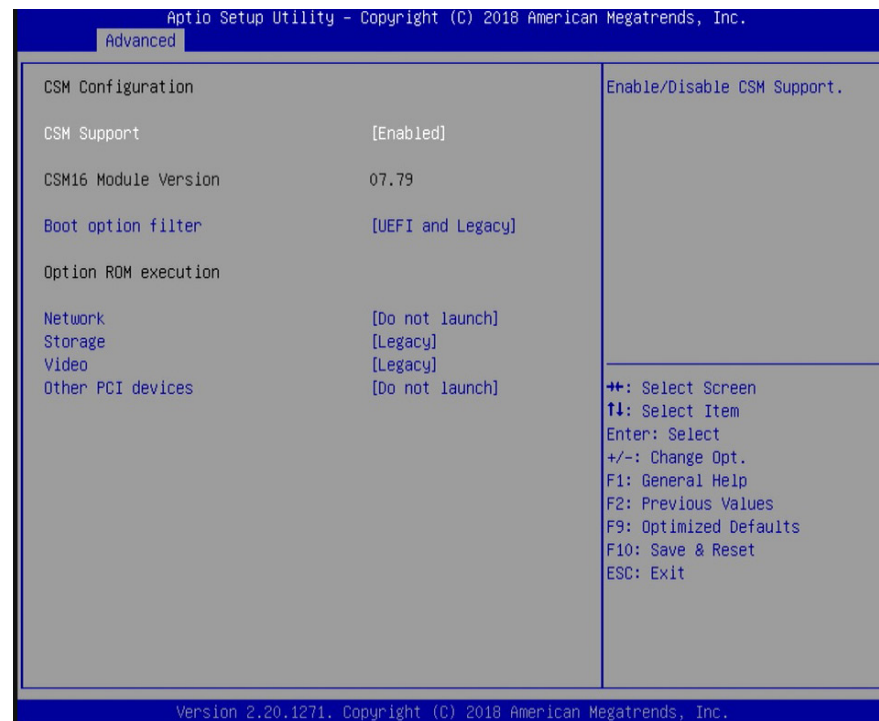

#### CSM Support

Enable or disable the CSM support. When the CSM support is enabled, UEFI BIOS will be able to execute legacy firmware drivers.

#### Boot option filter

Select the BIOS boot mode: UEFI and legacy, legacy only or UEFI only.

#### Network

Select to control the execution of network option ROM: Do not launch, UEFI or legacy.



#### Note:

When Secure Boot (please refer to "Security"> "Secure Boot" later in this chapter) is enabled, execution of the CSM and legacy ROMs are not allowed.

**CSM Support**

Enable or disable the CSM support. When the CSM support is enabled, UEFI BIOS will be able to execute legacy firmware drivers.

**Boot option filter**

Select the BIOS boot mode: UEFI and legacy, legacy only or UEFI only.

**Network**

Select to control the execution of network option ROM: Do not launch, UEFI or legacy.

**Storage**

Select to control the execution of storage option ROM: Do not launch, UEFI or legacy.

**Video**

Select to control the execution of video option ROM: Do not launch, UEFI or legacy.

**Other PCI devices**

Select to control the execution of option ROM for other PCI devices other than the above configured network, storage and video devices: Do not launch, UEFI or legacy.

## Security

This section configures the security for system boot and BIOS setup utility.

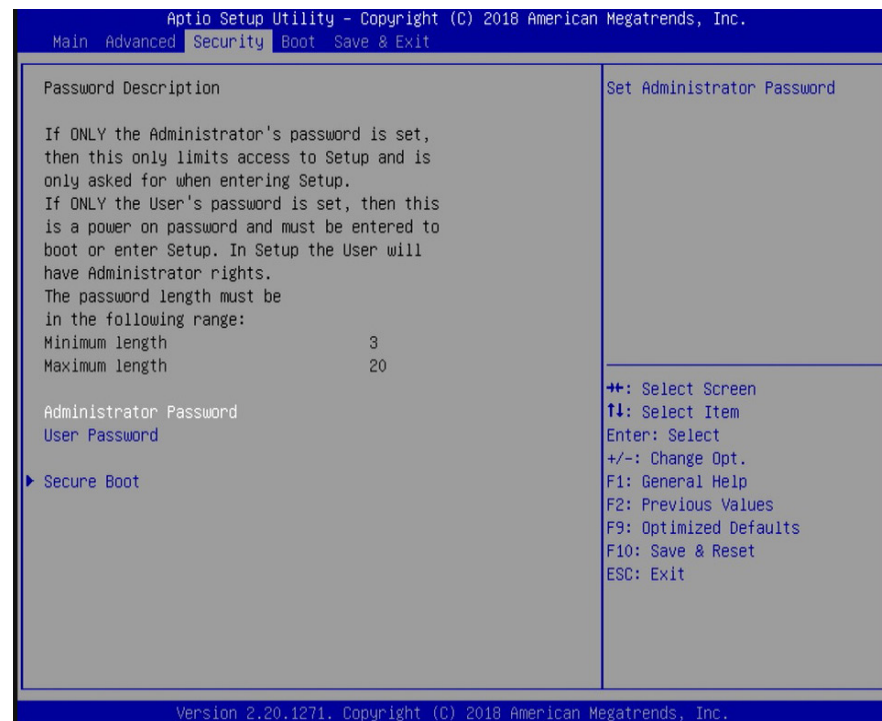
**Administrator Password**

Enter to set a new or change the existing administrator password.

**User Password**

Enter to set a new or change the existing user password.

Please note that passwords must be at least 3 and up to 20 characters long.

## Secure Boot

This section configures Secure Boot settings. This function is designed for advanced users; be careful when changing these settings. It's possible to cause the system not to start properly.

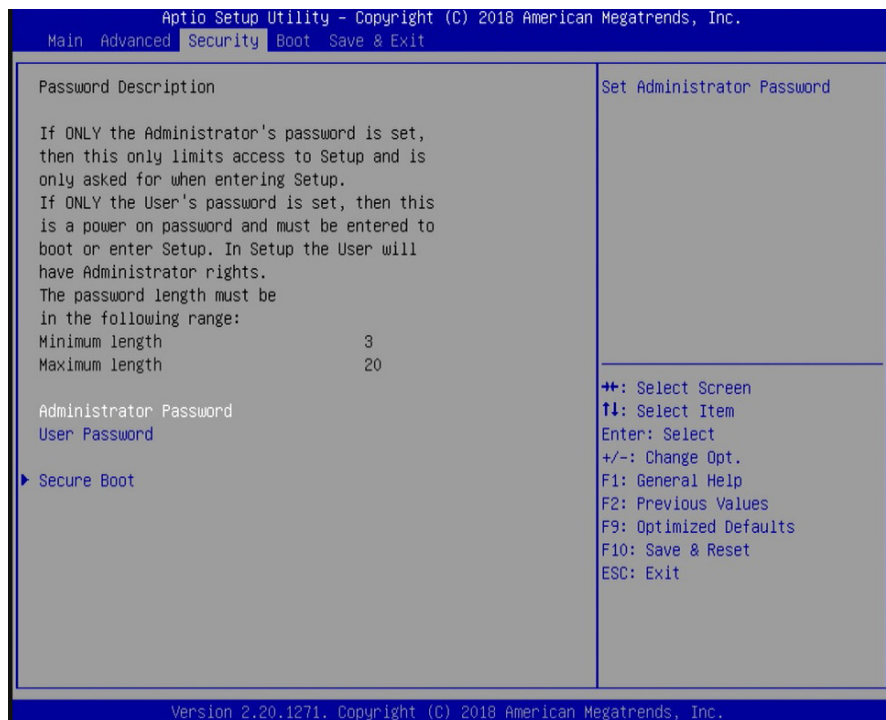

### Secure Boot

Secure Boot helps ensure that the system boot executes only firmware that is trusted by the manufacturer. This function can be enabled if the Platform Key (PK) is enrolled, and the System Mode is user/deployed and the CSM (please refer to "Advanced" > "CSM Configuration" earlier in this chapter) is disabled.

### Secure Boot Customization

Select Custom to customize the "Secure Boot" function or "Standard" to use the standard feature. If it is set to "Custom", the following functions can be configured:

### Restore Factory Keys

Select "Yes" to force the system to use the factory defaults settings. It will set the system to be in the "User Mode". It will also configure the NVRAM to contain pre-defined factory default Secure Boot keys.

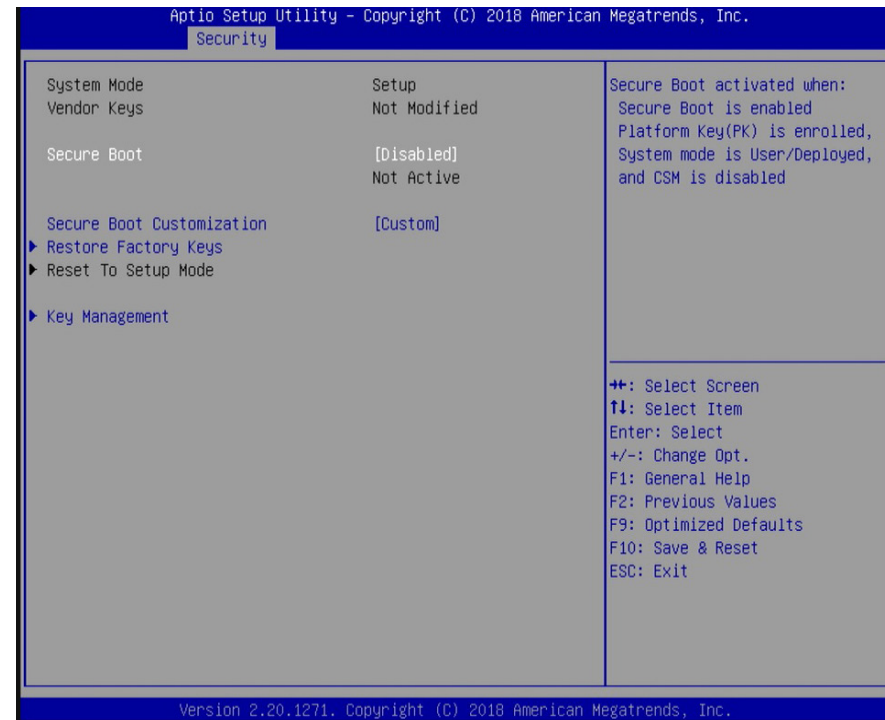

### Reset To Setup Mode

Select "Yes" to delete all UEFI secure boot keys stored in the NVRAM. It will also revert the system back to the Setup mode.

### Key Management

Manage Secure Boot keys such as Platform Key and Key Exchange Keys.

## Key Management

This section creates and manages the Secure Boot keys and certificates.

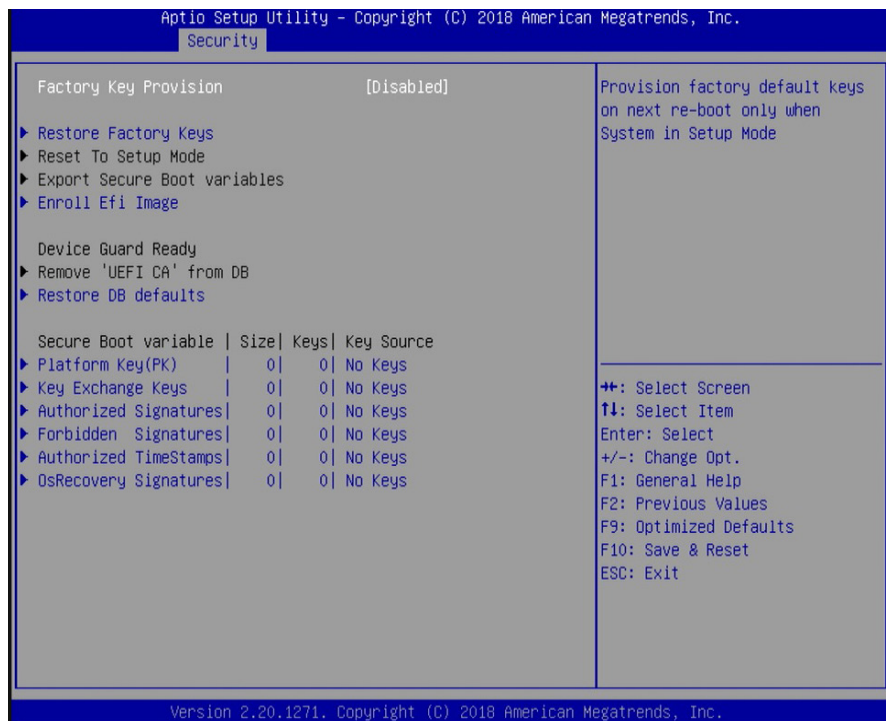

### Factory Key Provision

When the system is in the Setup Mode, you can provision the system with a configured factory default key.

### Restore Factory Keys

Select "Yes" to force the system to use the factory default settings. It will set the system to be in the User Mode. It will also configure the NVRAM to contain pre-defined factory default secure boot keys.

### Reset To Setup Mode

Select "Yes" to delete all UEFI Secure Boot key stored in the NVRAM. It will also revert the system back to the Setup Mode.

### Export Secure Boot Variables

Export the NVRAM content of Secure Boot configurations to a file in the root folder of a selected file system device.

### Enroll Efi Image

Enroll a SHA256 certificate of a PE image into the authorized signature database (DB) to allow the image to run in the Secure Boot mode.

### Remove UEFI CA from DB

Remove the Microsoft UEFI CA certificate from the authorized signature DB.

### Restore DB defaults

Restore DB variables to their factory defaults. You may also proceed to the next section: "Secure Boot Variable" to configure DB variables, including Platform Key (PK), Key Exchange Keys, Authorized Signatures, Forbidden Signatures, Authorized TimeStamps, OsRecovery Signatures. For each variable, you can choose to show the detailed information of the key(s) and export, update, append or delete the key(s).

## Boot

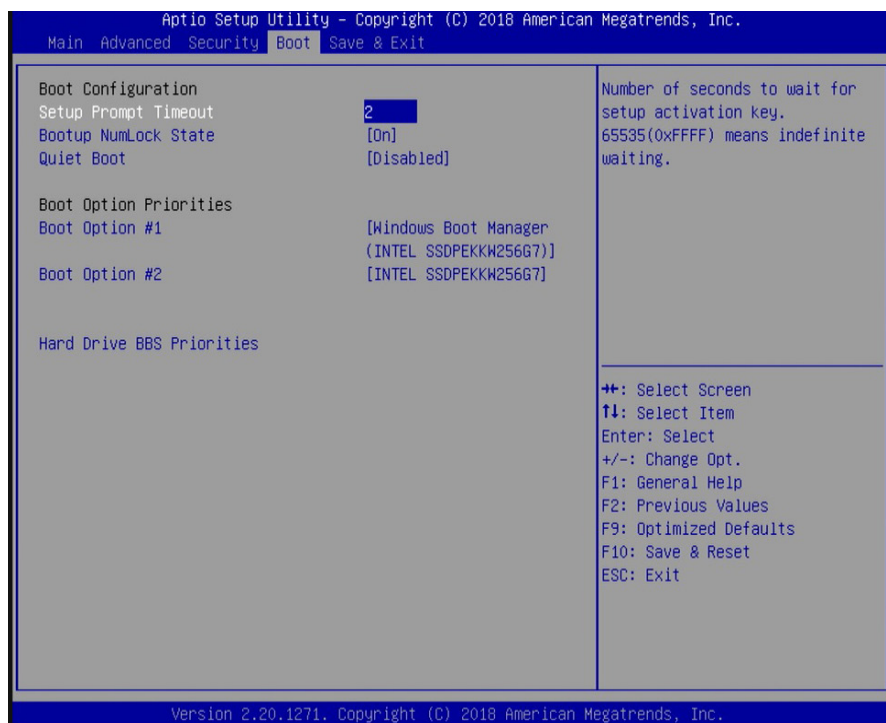

### Boot Option #1/#2

Set the boot order of the system boot devices.

### Hard Drive BBS Priorities

Set the boot order of the devices in this group.

### Setup Prompt Timeout

Select the number of seconds to wait for the BIOS setup activation key. 65535 (0xFFFF) denotes indefinite waiting.

### Bootup NumLock State

This option allows you to determine the default state of the numeric keypad. By default, the system boots up with NumLock on and the function of the numeric keypad is the number keys. When it is set to Off, the function of the numeric keypad is the arrow keys.

### Quiet Boot

Enable or disable the quiet boot function to configure the screen's display between POST messages or the OEM logo at bootup. Select Disabled to display the POST messages and select Enabled to display the OEM logo.



## Save & Exit



### Save Changes and Reset

To save the changes, select this field and then press <Enter>. A dialog box will appear. Select "Yes" to reset the system after saving all changes.

### Discard Changes and Exit

To discard the changes, select this field and then press <Enter>. A dialog box will appear. Select "Yes" to reset system setup configurations without saving any changes.

### Restore Defaults

To restore and load the optimized default values, select this field and then press <Enter>. A dialog box will appear. Select "Yes" to restore the default values of all the setup options.

## Updating the BIOS

To update the BIOS, you will need the new BIOS file and a flash utility. Please contact technical support or your sales representative for the latest BIOS file and the firmware update utility. For instructions on how to update BIOS with the flash utility, please see <https://www.dfi.com/tw/knowledge/video/5> from the Knowledge Base of the DFI website.

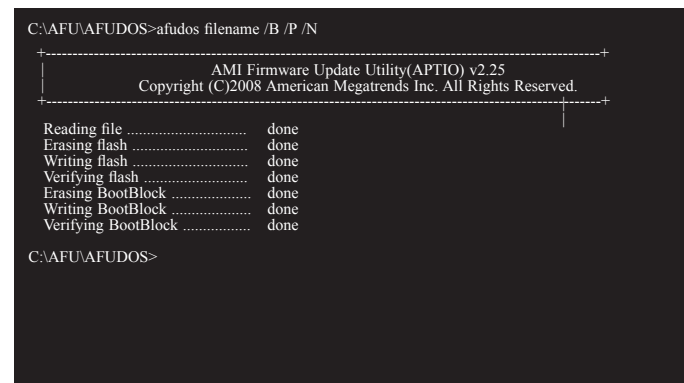

## Chapter 8 - Supported Software

---

The system requires you to install drivers for some devices to operate properly. To download the latest driver, please go to the DFI Download Center:

<http://www.dfi.com/DownloadCenter>

Once you are in the Download Center page, select your product or type the model name and click "Search" to find product-related resources such as documentation and drivers.

Drivers are available for the following devices in Windows 10:

- AMD® Chipset and VGA Drivers
- Realtek RTL8119 LAN Drivers
- Gaming Drivers

## AMD® Chipset and VGA Drivers

The AMD Radeon™ software provides drivers and configuration utilities for AMD Radeon™ Vega 11 Graphics. To install this software, click the executable file to begin the installation.

1. Read the End User License Agreement then click "Accept and Install" to continue the installation or click on X to stop the installation.

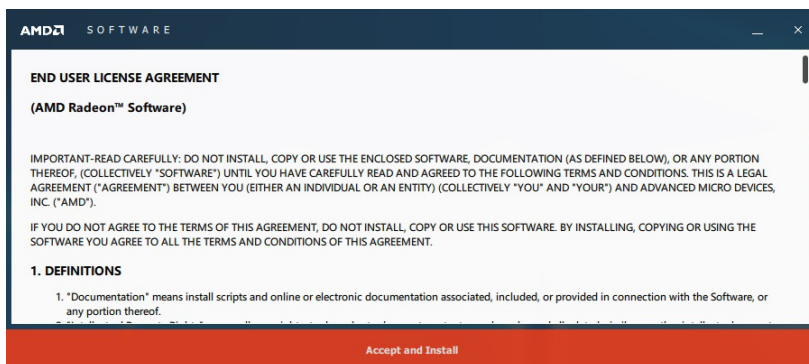

2. Choose between "Express Install" or "Custom Install". The "Express Install" installs all the programs in the default folder.

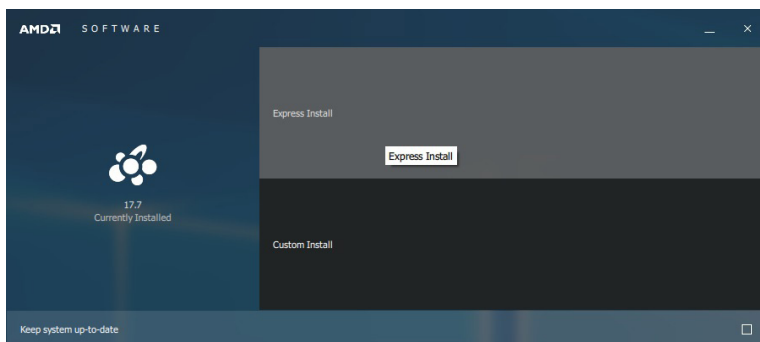

3. The "Custom Install" provides the option to select the programs that you would like to install and the folder for installation.

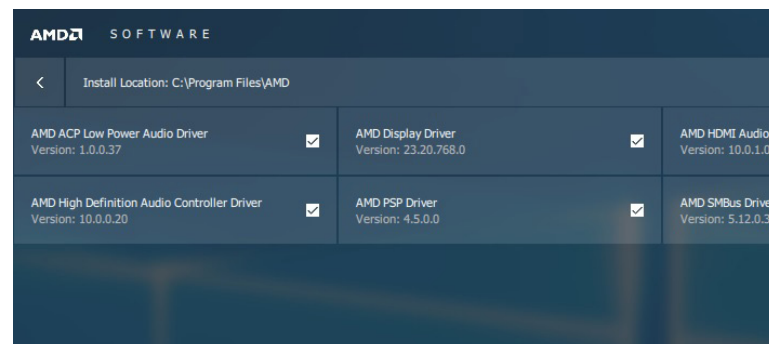

4. Please wait while the software and drivers are being installed.

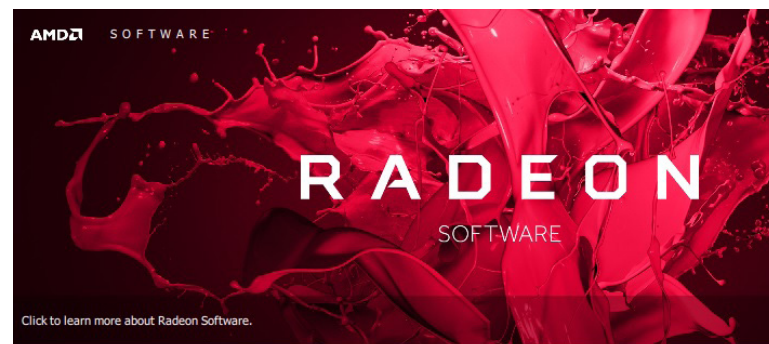

5. Once the Radeon™ Software has been successfully installed, choose "Restart Now".

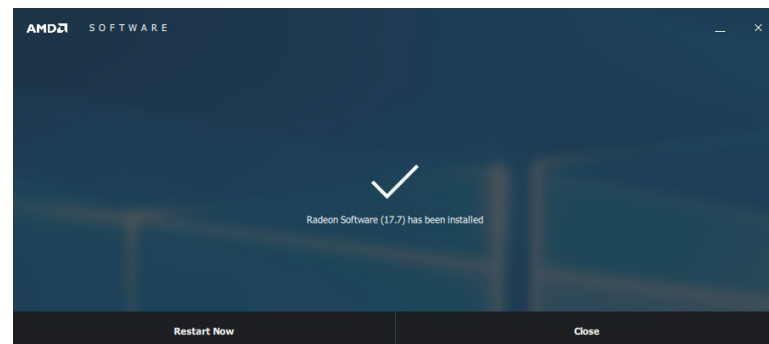

## Realtek LAN Drivers

The onboard LAN ports are provided by Realtek Gigabit Ethernet controllers. To install the driver, click the executable file inside the LAN Driver folder.

1. After the software package has done preparing the software package, click "Next" to continue.

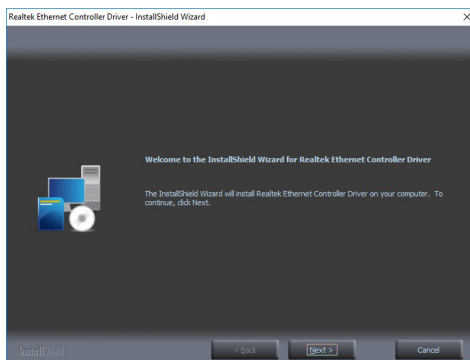

2. Click "Install" to start the installation.

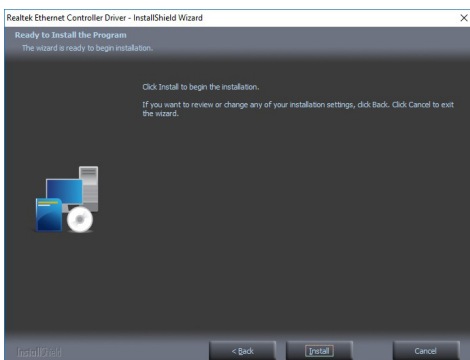

3. Click "Finish" to exit the wizard after the installation is complete.

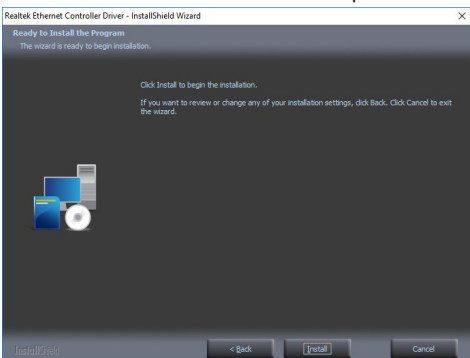

## WinDriver

The gaming platform employs digital input/output devices. For the digital I/O functions to work properly, the WinDriver USB/PCI driver must be installed. To install the driver, click the executable file inside the gaming driver folder.

1. Setup is now ready to install WinDriver USB/PCI Version 12.3.0. Click "Next" to continue.

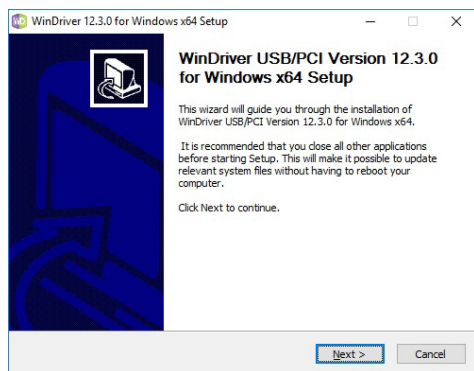

2. Read the license agreement then click "Yes" to continue.

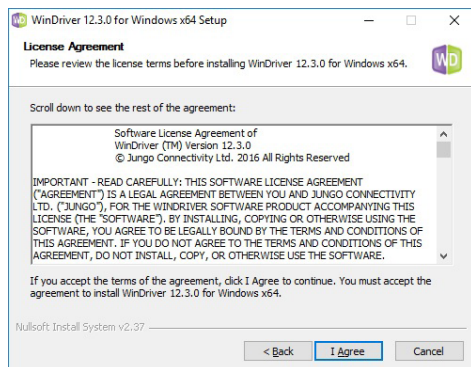

3. Follow the on-screen instructions to complete the rest of the installation process.

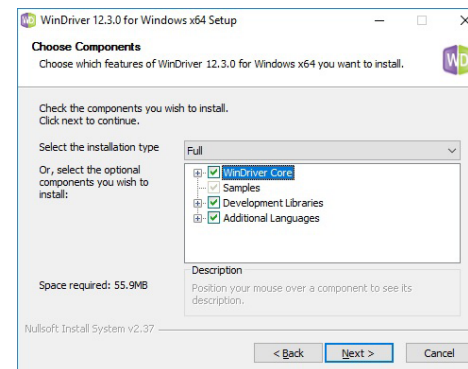

4. Please wait while the Setup is installing the driver.

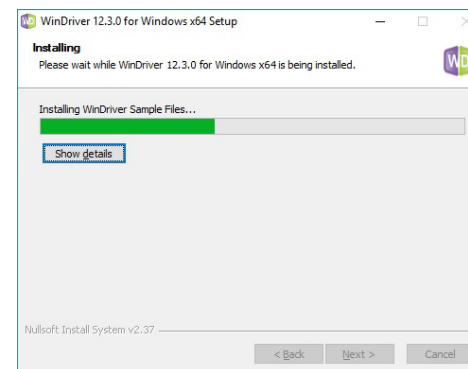

5. Click "Finish" to exit the Setup wizard.

