

# CS650-C246/Q370

ATX Industrial Motherboard  
User's Manual

## Copyright

This publication contains information that is protected by copyright. No part of it may be reproduced in any form or by any means or used to make any transformation/adaptation without the prior written permission from the copyright holders.

This publication is provided for informational purposes only. The manufacturer makes no representations or warranties with respect to the contents or use of this manual and specifically disclaims any express or implied warranties of merchantability or fitness for any particular purpose. The user will assume the entire risk of the use or the results of the use of this document. Further, the manufacturer reserves the right to revise this publication and make changes to its contents at any time, without obligation to notify any person or entity of such revisions or changes.

Changes after the publication's first release will be based on the product's revision. The website will always provide the most updated information.

© 2020. All Rights Reserved.

## Trademarks

Product names or trademarks appearing in this manual are for identification purpose only and are the properties of the respective owners.

## FCC and DOC Statement on Class B

This equipment has been tested and found to comply with the limits for a Class B digital device, pursuant to Part 15 of the FCC rules. These limits are designed to provide reasonable protection against harmful interference when the equipment is operated in a residential installation. This equipment generates, uses and can radiate radio frequency energy and, if not installed and used in accordance with the instruction manual, may cause harmful interference to radio communications. However, there is no guarantee that interference will not occur in a particular installation. If this equipment does cause harmful interference to radio or television reception, which can be determined by turning the equipment off and on, the user is encouraged to try to correct the interference by one or more of the following measures:

- Reorient or relocate the receiving antenna.
- Increase the separation between the equipment and the receiver.
- Connect the equipment into an outlet on a circuit different from that to which the receiver is connected.
- Consult the dealer or an experienced radio TV technician for help.

## Notice:

1. The changes or modifications not expressly approved by the party responsible for compliance could void the user's authority to operate the equipment.
2. Shielded interface cables must be used in order to comply with the emission limits.

# Table of Contents

Chapter 1 - Introduction.....	6
Specifications .....	6
CS650-C246 .....	6
CS650-Q370 .....	7
Features .....	8
Chapter 2 - Hardware Installation.....	9
Board Layout.....	9
Standby Power LED.....	9
System Memory .....	10
Installing the DIMM Module .....	10
Removing the DIMM Module.....	11
CPU.....	12
Installing the CPU .....	12
Installing the Fan and Heat Sink .....	14
Jumper Settings .....	15
Clear CMOS.....	15
COM 1 Serial Mode .....	15
COM 2 Serial Mode .....	16
COM 1/2 RS232 Power Select .....	16
Mini PCIe Signal Select.....	17
mSATA (Mini PCIe connector) / 7-pin SATA (SATA 3) Switch.....	17
Mini PCIe Power Select.....	18
Digital I/O (DIO) Power Supply.....	18
Digital I/O (DIO) Power Select.....	19
Rear I/O Ports.....	20
PS/2 Keyboard/Mouse.....	20
USB Ports.....	21
Graphics Display.....	21
RJ45 LAN .....	22
Audio.....	22
COM 1 (Serial) Port .....	23
Internal I/O Connectors .....	23
COM (Serial) Ports .....	23
USB Ports.....	24
Front Audio.....	25
SATA (Serial ATA) .....	25
Digital I/O .....	26
Cooling Fan Connectors.....	26
Power Connector.....	27
Chassis Intrusion.....	27
Front Panel.....	28
S/PDIF.....	28
Battery .....	29
SMBus .....	29
LPC .....	30
External COM port Module .....	30
LAN LED .....	31
Expansion Slots.....	31
Installing the M.2 Module .....	32
Installing the Mini PCIe Module .....	33

Chapter 3 - BIOS Settings.....	35
Overview .....	35
Main.....	36
Advanced .....	36
RC ACPI Configuration .....	37
CPU Configuration.....	37
Power & Performance .....	38
PCH-FW Configuration .....	38
Trusted Computing.....	41
NCT6116D Super IO Configuration .....	41
NCT6116D HW Monitor .....	42
Serial Port Console Redirection .....	43
USB Configuration .....	44
CSM Configuration .....	45
USB Power Control.....	45
Network Stack Configuration.....	46
Chipset .....	47
Graphics Configuration .....	47
PEG Port Configuration.....	48
PCH-IO Configuration .....	49
PCI Express Configuration .....	49
SATA And RST Configuration .....	50
HD Audio Configuration .....	50
Security .....	51
Secure Boot.....	51
Boot .....	52
Save & Exit .....	52
Updating the BIOS.....	53
Notice: BIOS SPI ROM.....	53
Chapter 4 - Intel AMT Settings.....	54
Overview .....	54
Enable Intel® AMT in the AMI BIOS .....	54
Entering Management Engine BIOS Extension (MEBX) .....	55
MEBX .....	56
Main Menu .....	56
Intel(R) ME General Settings .....	56
Intel(R) AMT Configuration.....	58
Chapter 5 - RAID.....	69
RAID Levels.....	69
Setup Procedure.....	69
Chapter 6 - Supported Software .....	71
Auto-run Menu .....	71
Intel Chipset Software Installation Utility.....	71
Intel HD Graphics Drivers .....	72
Realtek Audio Drivers.....	73
Intel LAN Driver .....	74
Intel ME Drivers .....	75
Intel Serial IO Drivers .....	76
Intel Rapid Storage Technology .....	77
Adobe Acrobat Reader 9.3 .....	79

## About this Manual

This manual can be downloaded from the website, or acquired as an electronic file included in the optional CD/DVD. The manual is subject to change and update without notice, and may be based on editions that do not resemble your actual products. Please visit our website or contact our sales representatives for the latest editions.

## Warranty

1. Warranty does not cover damages or failures that arised from misuse of the product, inability to use the product, unauthorized replacement or alteration of components and product specifications.
2. The warranty is void if the product has been subjected to physical abuse, improper installation, modification, accidents or unauthorized repair of the product.
3. Unless otherwise instructed in this user's manual, the user may not, under any circumstances, attempt to perform service, adjustments or repairs on the product, whether in or out of warranty. It must be returned to the purchase point, factory or authorized service agency for all such work.
4. We will not be liable for any indirect, special, incidental or consequential damages to the product that has been modified or altered.

## Static Electricity Precautions

It is quite easy to inadvertently damage your PC, system board, components or devices even before installing them in your system unit. Static electrical discharge can damage computer components without causing any signs of physical damage. You must take extra care in handling them to ensure against electrostatic build-up.

1. To prevent electrostatic build-up, leave the system board in its anti-static bag until you are ready to install it.
2. Wear an antistatic wrist strap.
3. Do all preparation work on a static-free surface.
4. Hold the device only by its edges. Be careful not to touch any of the components, contacts or connections.
5. Avoid touching the pins or contacts on all modules and connectors. Hold modules or connectors by their ends.



**Important:**

Electrostatic discharge (ESD) can damage your processor, disk drive and other components. Perform the upgrade instruction procedures described at an ESD workstation only. If such a station is not available, you can provide some ESD protection by wearing an antistatic wrist strap and attaching it to a metal part of the system chassis. If a wrist strap is unavailable, establish and maintain contact with the system chassis throughout any procedures requiring ESD protection.

## Safety Measures

- To avoid damage to the system, use the correct AC input voltage range.
- To reduce the risk of electric shock, unplug the power cord before removing the system chassis cover for installation or servicing. After installation or servicing, cover the system chassis before plugging the power cord.

## About the Package

The package contains the following items. If any of these items are missing or damaged, please contact your dealer or sales representative for assistance.

- One CS650-C246/CS650-Q370 board
- One Serial ATA data cable (Length: 500mm)
- One COM converter cable, pin headers to 2 DB9 (Length: 300mm)
- One I/O shield
- Two standoff screws (M2x4 mm I-head)
- One Quick Reference

The board and accessories in the package may not come similar to the information listed above. This may differ in accordance with the sales region or models in which it was sold. For more information about the standard package in your region, please contact your dealer or sales representative.

## Optional Items

- USB 2.0 / USB 3.1 cable
- COM cable
- SATA cable
- Thermal Solution (Heat sink and fan)
- EXT-RS232 / EXT-RS485 module (4 external ports via LPC connector)
- DP-to-HDMI dongle

The board and accessories in the package may not come similar to the information listed above. This may differ in accordance with the sales region or models in which it was sold. For more information about the standard package in your region, please contact your dealer or sales representative.

## Before Using the System Board

When installing the system board in a new system, you will need at least the following internal components.

- CPU
- Memory module
- Storage device such as hard disk drive, CD-ROM, etc.
- Power adaptor

External system peripherals may also be required for navigation and display, including at least a keyboard, a mouse and a video display monitor.

## Chapter 1 - Introduction

### ► Specifications

#### CS650-C246

<b>SYSTEM</b>	<b>Processor</b>	8th Generation Intel® Core™ /Pentium®/Celeron® LGA 1151 Socket Processors, TDP support up to 95W: Xeon® E-2176G (6 Cores, 12M Cache, up to 4.7 GHz); 80W Xeon® E-2124G (4 Cores, 8M Cache, up to 4.5 GHz); 71W Core™ i7-8700 (6 Cores, 12M Cache, up to 4.6 GHz); 65W Core™ i7-8700T (6 Cores, 12M Cache, up to 4.0 GHz); 35W Core™ i5-8500 (6 Cores, 9M Cache, up to 4.1 GHz); 65W Core™ i5-8500T (6 Cores, 9M Cache, up to 3.5 GHz); 35W Core™ i3-8100 (4 Cores, 6M Cache, 3.6 GHz); 65W Core™ i3-8100T (4 Cores, 6M Cache, to 3.1 GHz); 35W Pentium® G5400 (2 Cores, 4M Cache, 3.7 GHz); 58W Pentium® G5400T (2 Cores, 4M Cache, 3.1 GHz); 35W Celeron® G4900 (2 Cores, 2M Cache, 3.1 GHz); 54W Celeron® G4900T (2 Cores, 2M Cache, 2.9 GHz); 35W 9th Generation Intel® Core™ LGA 1151 Socket Processors, TDP support up to 95W: Xeon® E-2278GE (8 Cores, 16M Cache, up to 4.7 GHz); 80W Xeon® E-2278GEL (8 Cores, 16M Cache, up to 3.9 GHz); 35W Xeon® E-2226GE (6 Cores, 12M Cache, up to 4.6 GHz); 80W Core™ i7-9700E (8 Cores, 12M Cache, up to 4.4 GHz); 65W Core™ i7-9700TE (8 Cores, 12M Cache, up to 3.8 GHz); 35W Core™ i5-9500E (6 Cores, 9M Cache, up to 4.2 GHz); 65W Core™ i5-9500TE (6 Cores, 9M Cache, up to 3.6 GHz); 35W Core™ i3-9100E (4 Cores, 6M Cache, 3.7 GHz); 65W Core™ i3-9100TE (4 Cores, 6M Cache, to 3.2 GHz); 35W
	<b>Chipset</b>	Intel® C246 Chipset
	<b>Memory</b>	Four 288-pin ECC/Non-ECC DIMM up to 128GB (Core™ i5/i7 only support non-ECC) Dual Channel DDR4 2400/2666MHz
	<b>BIOS</b>	AMI SPI 128Mbit
<b>GRAPHICS</b>	<b>Controller</b>	Intel® HD Gen 9 Graphics
	<b>Feature</b>	OpenGL 5.0, DirectX 12, OpenCL 2.1 HW Decode: AVC/H.264, MPEG2, VC1/WMV9, JPEG/MJPEG, HEVC/H265, VP8, VP9 HW Encode: MPEG2, AVC/H264, JPEG, HEVC/H265, VP8, VP9
	<b>Display</b>	1 x VGA, resolution up to 1920x1200 @ 60Hz 2 x DP++, resolution up to 4096x2160 @ 60Hz
	<b>Triple Displays</b>	VGA + DP++ + DP++

<b>EXPANSION</b>	<b>Interface</b>	2 x PCIe x16 (Gen 3) (1 x16 signal or 2 x8 signals) 3 x PCIe x4 (Gen 3) 1 x PCIe x1 (Gen 3) 1 x PCI 1 x Full-sized Mini PCIe (PCIe/SATA/USB2.0), share with SATA 3(R5) 1 x M.2 2242/2260/2280 M key (PCIe Gen3 x4 NVMe)
	<b>AUDIO</b>	<b>Audio Codec</b> Realtek ALC888
	<b>ETHERNET</b>	<b>Controller</b> 1 x Intel® I210AT PCIe (10/100/1000Mbps) 1 x Intel® I219LM PCIe with iAMT12.0 (10/100/1000Mbps) (only Xeon, Core i7/i5 supports iAMT)
<b>REAR I/O</b>	<b>Ethernet</b>	2 x GbE (RJ-45)
	<b>USB</b>	2 x USB 3.1 Gen2 2 x USB 3.1 Gen1 2 x USB 2.0
	<b>Serial</b>	1 x RS-232/422/485 (RS-232 w/ power) (DB-9)
	<b>PS/2</b>	1 x PS/2 (mini-DIN-6)
	<b>Display</b>	1 x VGA, 2 x DP++
	<b>Audio</b>	1 x Line-out, 1 x Mic-in, 1 x Line-in (opt., MOQ required)
<b>INTERNAL I/O</b>	<b>Serial</b>	1 x RS-232/422/485 (RS-232 w/ power) (2.54mm pitch) 4 x RS-232 (2.54mm pitch)
	<b>USB</b>	2 x USB 3.1 Gen 1 (2.00mm pitch) 4 x USB 2.0 (2.54mm pitch) (1 x USB 2.0 colay vertical Type A) (opt., MOQ required)
	<b>Audio</b>	1 x Front Audio Header 1 x S/PDIF
	<b>SATA</b>	4 x SATA 3.0 (up to 6Gb/s, SATA 3(R5) shared with mini PCIe (SATA), default at mini PCIe) RAID 0/1/5/10
	<b>DIO</b>	1 x 8-bit DIO
	<b>LPC</b>	1 x LPC (supports LPC EXT-RS232/RS485 module)
	<b>SMBus</b>	1 x SMBus
<b>WATCHDOG TIMER</b>	<b>Output &amp; Interval</b>	System Reset, Programmable via Software from 1 to 255 Seconds
<b>SECURITY</b>	<b>TPM</b>	Infineon TPM2.0 (opt., MOQ required)
<b>POWER</b>	<b>Type</b>	ATX
	<b>Connector</b>	8-pin ATX 12V power 24-pin ATX power
	<b>RTC Battery</b>	CR2032 Coin Cell
<b>OS SUPPORT</b>		Windows 10 IoT Enterprise 64-bit/ Windows 11 GAC Linux
<b>ENVIRONMENT</b>	<b>Temperature</b>	Operating: 0 to 60°C Storage: -30 to 60°C with RTC Battery; -40 to 85°C without RTC Battery
	<b>Humidity</b>	Operating: 5 to 90% RH; Storage: 5 to 90% RH
<b>MECHANICAL</b>	<b>Dimensions</b>	ATX Form Factor: 305mm (12") x 244mm (9.6")
	<b>Height</b>	PCB: 1.6mm
<b>CERTIFICATIONS</b>		CE, FCC Class B, RoHS

► Specifications

CS650-Q370

<b>SYSTEM</b>	<b>Processor</b>	8th Generation Intel® Core™ /Pentium®/Celeron® LGA 1151 Socket Processors, TDP support up to 95W: Core™ i7-8700 (6 Cores, 12M Cache, up to 4.6 GHz); 65W Core™ i7-8700T (6 Cores, 12M Cache, up to 4.0 GHz); 35W Core™ i5-8500 (6 Cores, 9M Cache, up to 4.1 GHz); 65W Core™ i5-8500T (6 Cores, 9M Cache, up to 3.5 GHz); 35W Core™ i3-8100 (4 Cores, 6M Cache, 3.6 GHz); 65W Core™ i3-8100T (4 Cores, 6M Cache, to 3.1 GHz); 35W Pentium® G5400 (2 Cores, 4M Cache, 3.7 GHz); 58W Pentium® G5400T (2 Cores, 4M Cache, 3.1 GHz); 35W Celeron® G4900 (2 Cores, 2M Cache, 3.1 GHz); 54W Celeron® G4900T (2 Cores, 2M Cache, 2.9 GHz); 35W  9th Generation Intel® Core™ LGA 1151 Socket Processors, TDP support up to 95W: Core™ i7-9700E (8 Cores, 12M Cache, up to 4.4 GHz); 65W Core™ i7-9700TE (8 Cores, 12M Cache, up to 3.8 GHz); 35W Core™ i5-9500E (6 Cores, 9M Cache, up to 4.2 GHz); 65W Core™ i5-9500TE (6 Cores, 9M Cache, up to 3.6 GHz); 35W Core™ i3-9100E (4 Cores, 6M Cache, 3.7 GHz); 65W Core™ i3-9100TE (4 Cores, 6M Cache, to 3.2 GHz); 35W
	<b>Chipset</b>	Intel® Q370 Chipset
	<b>Memory</b>	Four 288-pin DIMM up to 128GB , Dual Channel DDR4 2400/2666MHz
	<b>BIOS</b>	AMI SPI 128Mbit
<b>GRAPHICS</b>	<b>Controller</b>	Intel® HD Gen 9 Graphics
	<b>Feature</b>	OpenGL 5.0, DirectX 12, OpenCL 2.1 HW Decode: AVC/H.264, MPEG2, VC1/WMV9, JPEG/MJPEG, HEVC/H265, VP8, VP9 HW Encode: MPEG2, AVC/H264, JPEG, HEVC/H265, VP8, VP9
	<b>Display</b>	1 x VGA, resolution up to 1920x1200 @ 60Hz 2 x DP++, resolution up to 4096x2160 @ 60Hz
	<b>Triple Displays</b>	VGA + DP++ + DP++
<b>EXPANSION</b>	<b>Interface</b>	2 x PCIe x16 (Gen 3) (1 x16 signal or 2 x8 signals) 1 x PCIe x1 (Gen 3) 3 x PCIe x4 (Gen 3) 1 x PCI 1 x Full-sized Mini PCIe (PCIe/SATA/USB2.0), share with SATA 3(R5) 1 x M.2 2242/2260/2280 M key (PCIe Gen3 x 4 NVMe)
	<b>AUDIO</b>	<b>Audio Codec</b> Realtek ALC888
<b>ETHERNET</b>	<b>Controller</b>	1 x Intel® I210AT PCIe (10/100/1000Mbps) 1 x Intel® I219LM PCIe with iAMT12.0 (10/100/1000Mbps) (only Core i7/ i5 supports iAMT)

<b>REAR I/O</b>	<b>Ethernet</b>	2 x GbE (RJ-45)
	<b>USB</b>	2 x USB 3.1 Gen2 2 x USB 2.0 2 x USB 3.1 Gen1
	<b>Serial</b>	1 x RS-232/422/485 (RS-232 w/ power) (DB-9)
	<b>PS/2</b>	1 x PS/2 (mini-DIN-6)
	<b>Display</b>	1 x VGA 2 x DP++
	<b>Audio</b>	1 x Line-out, 1 x Mic-in, 1 x Line-in (opt., MOQ required)
<b>INTERNAL I/O</b>	<b>Serial</b>	1 x RS-232/422/485 (RS-232 w/ power) (2.54mm pitch) 4 x RS-232 (2.54mm pitch)
	<b>USB</b>	2 x USB 3.1 Gen 1 (2.00mm pitch) 4 x USB 2.0 (2.54mm pitch) (1 x USB 2.0 colay vertical Type A) (opt., MOQ required)
	<b>Audio</b>	1 x Front Audio Header 1 x S/PDIF
	<b>SATA</b>	4 x SATA 3.0 (up to 6Gb/s, SATA 3(R5) shared with mini PCIe (SATA), default at mini PCIe) RAID 0/1/5/10
	<b>DIO</b>	1 x 8-bit DIO
	<b>LPC</b>	1 x LPC (supports LPC EXT-RS232/RS485 module)
	<b>SMBus</b>	1 x SMBus
<b>WATCHDOG TIMER</b>	<b>Output &amp; Interval</b>	System Reset, Programmable via Software from 1 to 255 Seconds
<b>SECURITY</b>	<b>TPM</b>	Infineon TPM2.0 (opt., MOQ required)
<b>POWER</b>	<b>Type</b>	ATX
	<b>Connector</b>	8-pin ATX 12V power 24-pin ATX power
	<b>RTC Battery</b>	CR2032 Coin Cell
<b>OS SUPPORT</b>		Windows 10 IoT Enterprise 64-bit/ Windows 11 GAC Linux
<b>ENVIRONMENT</b>	<b>Temperature</b>	Operating: -10 to 70°C Storage: -30 to 60°C with RTC Battery; -40 to 85°C without RTC Battery
	<b>Humidity</b>	Operating: 5 to 90% RH Storage: 5 to 90% RH
<b>MECHANICAL</b>	<b>Dimensions</b>	ATX Form Factor: 305mm (12") x 244mm (9.6")
	<b>Height</b>	PCB: 1.6mm
<b>CERTIFICATIONS</b>		CE, FCC Class B, RoHS

## ► Features

### Watchdog Timer

The Watchdog Timer function allows your application to regularly “clear” the system at the set time interval. If the system hangs or fails to function, it will reset at the set time interval so that your system will continue to operate.

### DDR4

DDR4 delivers increased system bandwidth and improves performance. The advantages of DDR4 provide an extended battery life and improve the performance at a lower power than DDR3/DDR2.

### Graphics

The integrated Intel® HD graphics engine delivers an excellent blend of graphics performance and features to meet business needs. It provides excellent video and 3D graphics with outstanding graphics responsiveness. These enhancements deliver the performance and compatibility needed for today's and tomorrow's business applications.

### Serial ATA

Serial ATA is a storage interface that is compliant with SATA 1.0a specification. With speed of up to 6Gb/s (SATA 3.0), it improves hard drive performance faster than the standard parallel ATA whose data transfer rate is 100MB/s.

### Gigabit LAN

The Intel® I219LM and Intel® I210AT Gigabit Ethernet Controllers support data transmission at 1Gbps. Two additional GbE ports powered by Realtek 8365MB serve as hubs for Layer 2 switching.

### Audio

The Realtek ALC888S-VD2-GR audio codec provides 5.1 channel High Definition audio output.

### Wake-On-LAN

This feature allows the network to remotely wake up a Soft Power Down (Soft-Off) PC. It is supported via the onboard LAN port or via a PCI LAN card that uses the PCI PME (Power Management Event) signal. However, if your system is in the Suspend mode, you can power-on the system only through an IRQ or DMA interrupt.

### Wake-On-USB

This function allows you to use a USB keyboard or USB mouse to wake up a system from the S3 (STR - Suspend To RAM) state.

### PCI Express

PCI Express is a high bandwidth I/O infrastructure that possesses the ability to scale speeds by forming multiple lanes. The x4 PCI Express lane supports transfer rate of 4 Gigabyte per second (2 directions). The PCI Express architecture also supports high performance graphics infrastructure by enhancing the capability of a PCIe x16 Gen 3 at 16GB/s bandwidth (8GB/s in each direction).

### ACPI STR

The system board is designed to meet the ACPI (Advanced Configuration and Power Interface) specification. ACPI has energy saving features that enables PCs to implement Power Management and Plug-and-Play with operating systems that support OS Direct Power Management. ACPI when enabled in the Power Management Setup will allow you to use the Suspend to RAM function.

With the Suspend to RAM function enabled, you can power-off the system at once by pressing the power button or selecting “Standby” when you shut down Windows® without having to go through the sometimes tiresome process of closing files, applications and operating system. This is because the system is capable of storing all programs and data files during the entire operating session into RAM (Random Access Memory) when it powers-off. The operating session will resume exactly where you left off the next time you power-on the system.

### Power Failure Recovery

When power returns after an AC power failure, you may choose to either power-on the system manually or let the system power-on automatically.

### USB

The system board supports the new USB 3.1 Gen 2. It is capable of running at a maximum transmission speed of up to 10 Gbit/s (1.2 GB/s) and is faster than USB 3.1 Gen 1 (5 Gbit/s, or 625 MB/s), USB 2.0 (480 Mbit/s, or 60 MB/s) and USB 1.1 (12Mb/s). USB 3.1 reduces the time required for data transmission, reduces power consumption, and is backward compatible with USB 2.0. It is a marked improvement in device transfer speeds between your computer and a wide range of simultaneously accessible external Plug and Play peripherals.

### RTC Timer

The Real Time Clock (RTC) installed on the system board allows your system to automatically power-on on the set date and time.



**Chapter 2 - Hardware Installation**

**▶ Board Layout**

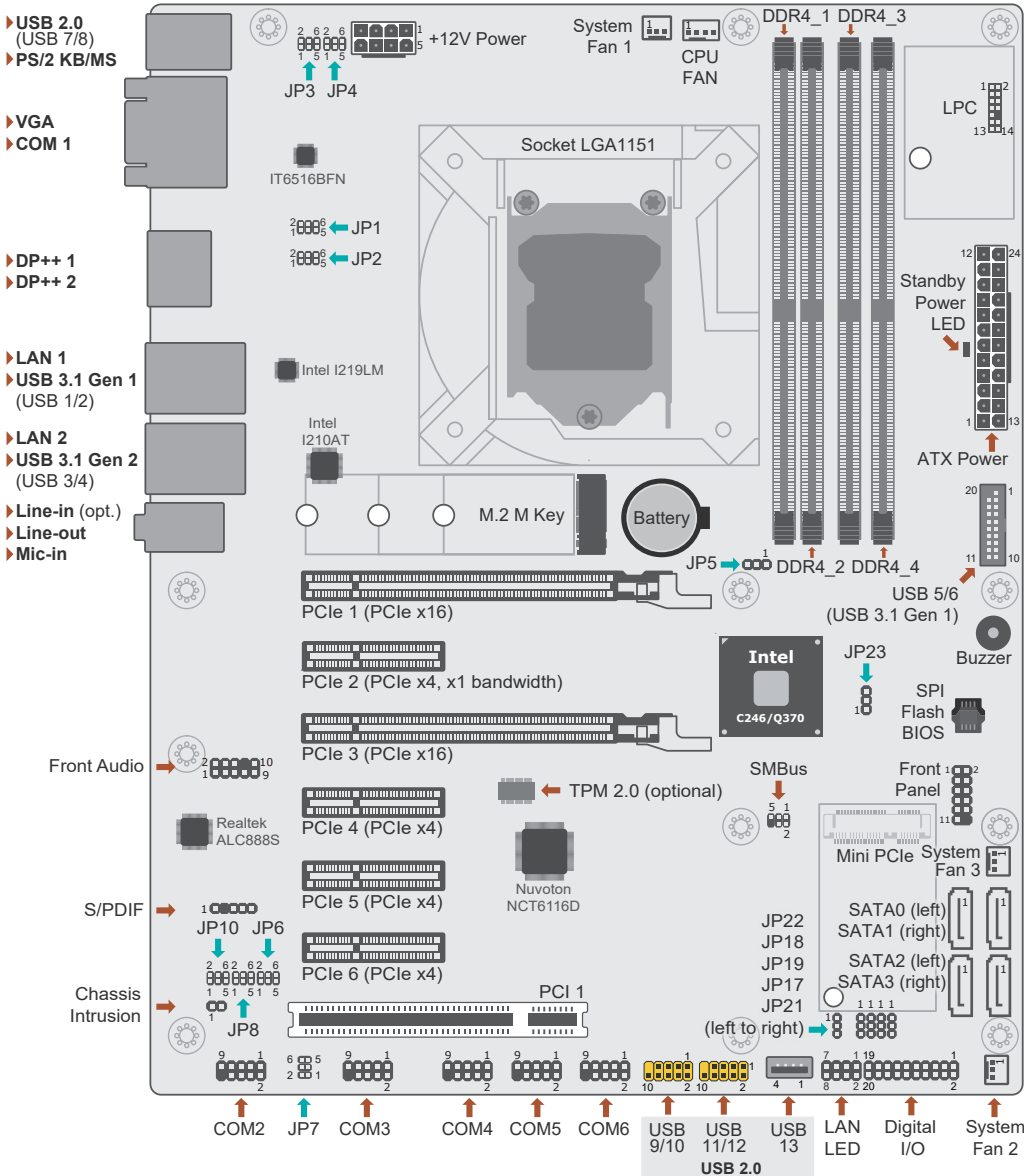

**Note:**  
 These optional components are only available upon request.

**Important:**  
 Electrostatic discharge (ESD) can damage your board, processor, disk drives, add-in boards, and other components. Perform installation procedures at an ESD workstation only. If such a station is not available, you can provide some ESD protection by wearing an antistatic wrist strap and attaching it to a metal part of the system chassis. If a wrist strap is unavailable, establish and maintain contact with the system chassis throughout any procedures requiring ESD protection.

**▶ Standby Power LED**

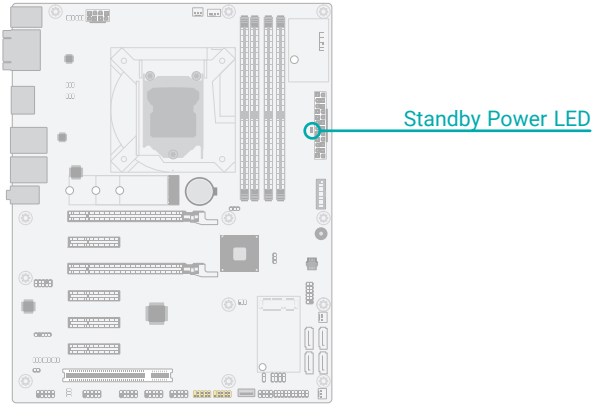

**Important:**  
 When the Standby Power LED lit red, it indicates that there is power on the system board. Power-off the PC then unplug the power cord prior to installing any devices. Failure to do so will cause severe damage to the motherboard and components.

► **System Memory**

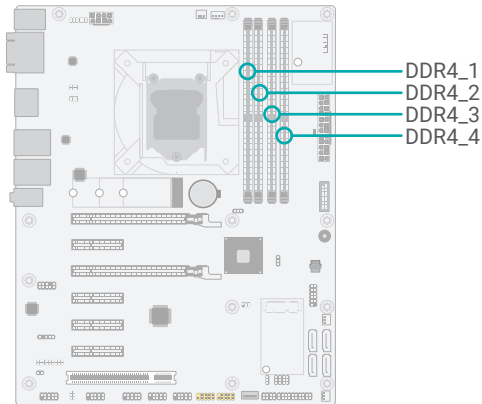

The system board supports the following memory interface.

**Single Channel (SC)**

Data will be accessed in chunks of 64 bits from the memory channels.

**Dual Channel (DC)**

Data will be accessed in chunks of 128 bits from the memory channels. Dual channel provides better system performance because it doubles the data transfer rate.

**Single Channel**

DIMMs are on the same channel. DIMMs in a channel can be identical or completely different. However, we highly recommend using identical DIMMs. Not all slots need to be populated.

**Dual Channel**

DIMMs of the same memory configuration are on different channels.

**Features**

- CS650-C246: Four 288-pin ECC/Non-ECC DIMM up to 64GB
- CS650-Q370: Four 288-pin Non-ECC DIMM up to 64GB
- Dual Channel DDR4 2400/2666 MHz

► **System Memory**

**Installing the DIMM Module**

Before installing the memory module, please make sure that the following safety cautions are well-attended.

1. Make sure the PC and all other peripheral devices connected to it has been powered down.
2. Disconnect all power cords and cables.
3. Locate the DIMM socket on the system board
4. Make sure the notch on memory card is aligned to the key on the socket.

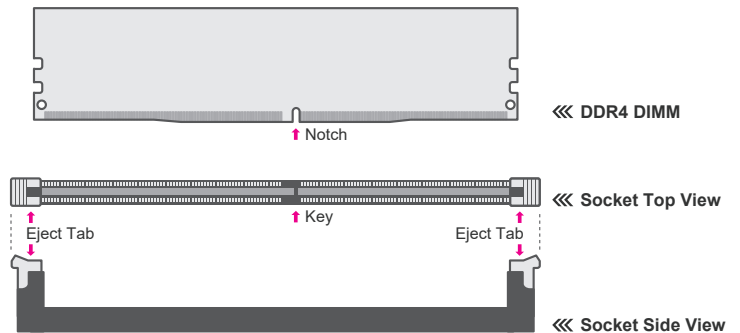

► System Memory ► Installing the DIMM Module

Please follow the steps below to install the memory card into the socket.

**Step 1:**  
Press the eject tabs at both ends of the socket outward and downward to release them from the locked position.

**Step 2:**  
Insert the memory card into the slot while making sure the notch and the key are aligned. Press the card down firmly with fingers while applying and maintaining even pressure on both ends.

**Step 3:**  
The tabs snap automatically to the edges of the card and lock the card in place.

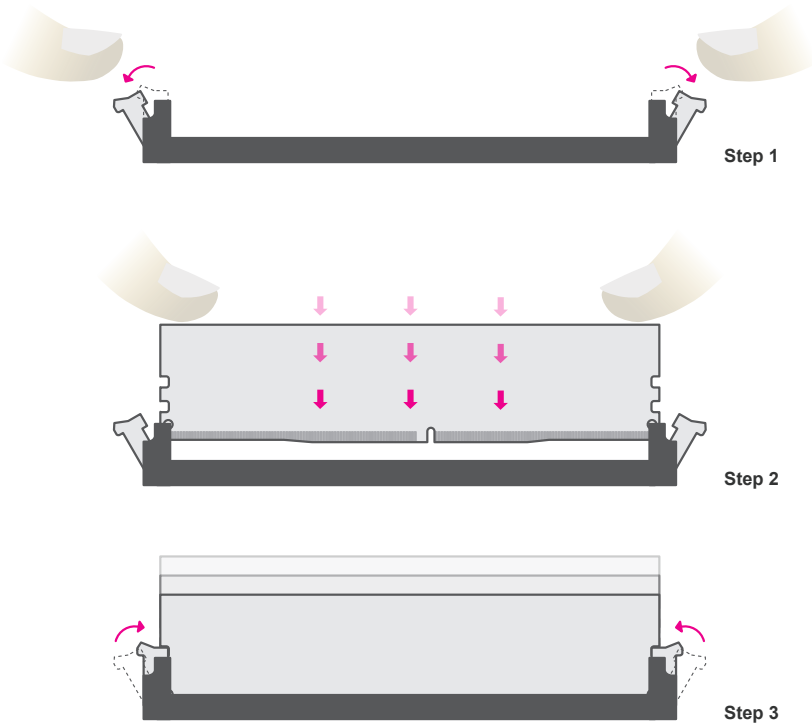

► System Memory

**Removing the DIMM Module**

Please follow the steps below to remove the memory card from the socket.

**Step 1:**  
Press the eject tabs at both ends of the socket outward and downward to release them from the locked position.

**Step 2:**  
The memory card ejects from the slot automatically.

**Step 3:**  
Hold the card by its edges and remove it from the slot.

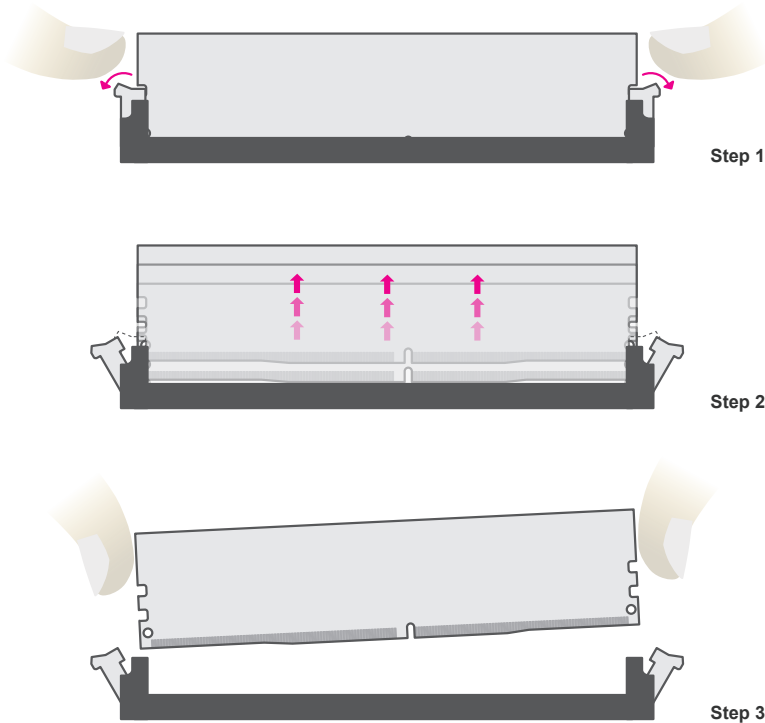

► CPU

The system board is equipped with a surface mount LGA 1151 socket. This socket is exclusively designed for installing a LGA 1151 packaged Intel CPU.



**Important:**

- 1. Before you proceed, make sure (1) the LGA 1151 socket comes with a protective cap, (2) the cap is not damaged and (3) the socket's contact pins are not bent. If the cap is missing or the cap and/or contact pins are damaged, contact your dealer immediately.
- 2. Make sure to keep the protective cap. RMA requests will be accepted and processed only if the LGA 1151 socket comes with the protective cap.



Protective cap



**Note:**

The system board used in the following illustrations may not resemble the actual board. These illustrations and photos are for reference only.

Installing the CPU

- 1. Make sure the PC and all other peripheral devices connected to it have been powered down.
- 2. Disconnect all power cords and cables.

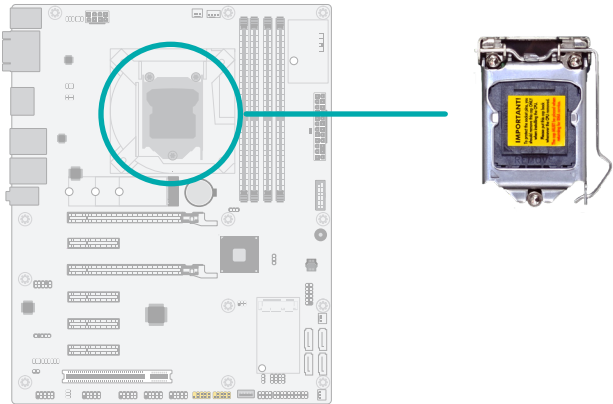

- 3. Locate the LGA 1151 CPU socket on the system board.



**Important:**

The CPU socket must not come in contact with anything other than the CPU. Avoid unnecessary exposure. Remove the protective cap only when you are about to install the CPU.

- 4. Unlock the socket by pressing the load lever down, moving it sideways until it escapes the retention tab. Lift the load lever up when it's released.



Load lever

Retention tab

CPU ▶ Installing the CPU

5. Lift the load lever and the load plate all the way up as shown in the photo.



6. Remove the protective cap from the CPU socket. The cap is used to protect the CPU socket against dust and harmful particles. Remove the protective cap only when you are about to install the CPU.

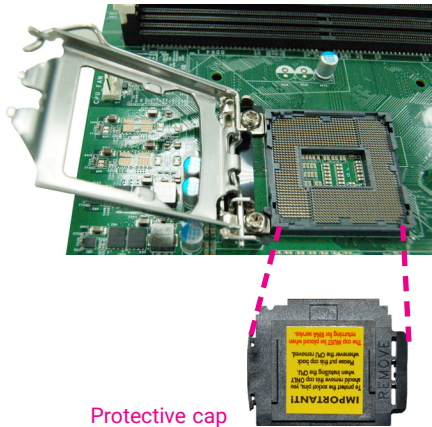

7-1. Insert the CPU into the socket. The gold triangular mark on the CPU must align with the chamfer corner of the CPU socket shown in the photo.



**Important:** The CPU will fit in only one orientation and can easily be seated without exerting any force.

CPU ▶ Installing the CPU

7-2. Two keys on the socket and notches on the CPU also facilitate alignment.

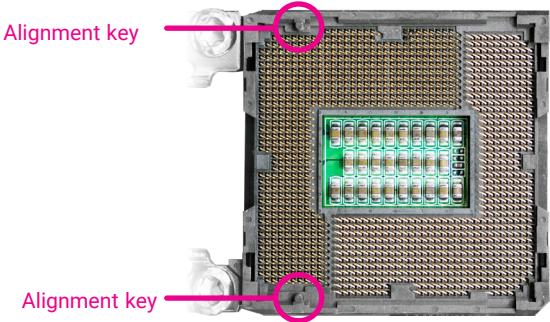

7-3. The CPU's notch will fit into the socket's alignment key when it's seated in the correct orientation.

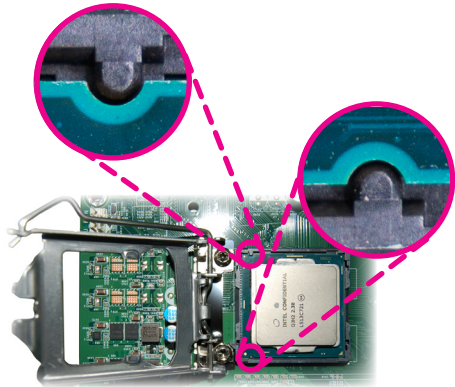

8. Close the load plate then push the load lever down.

While closing the load plate, make sure the front edge of the load plate slides under the retention knob.

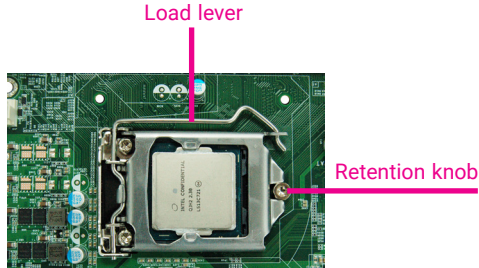

9. Press down the load lever and hook it under the retention tab.

▶ CPU

Installing the Fan and Heat Sink

The CPU must be kept cool by using a CPU fan with heat sink. Without sufficient air circulation across the CPU and heat sink, the CPU will overheat damaging both the CPU and system board.



**Note:** A boxed Intel® processor already includes the CPU fan and heat sink assembly. If your CPU was purchased separately, make sure to only use Intel®-certified fan and heat sink.

- 1. Before you install the fan / heat sink, you must apply a thermal paste onto the top of the CPU. The thermal paste is usually supplied when you purchase the fan / heat sink assembly. Do not spread the paste all over the surface. When you later place the heat sink on top of the CPU, the compound will disperse evenly.

Some heat sinks come with a patch of pre-applied thermal paste. Do not apply thermal paste if the fan / heat sink already has a patch of thermal paste on its underside. Peel the strip that covers the paste before you place the fan / heat sink on top of the CPU.

- 2. Place the heat sink on top of the CPU. The 4 spring screws around the heat sink, which are used to secure the heat sink onto the system board, must match the 4 mounting holes around the socket.

- 3. Orient the heat sink so that the CPU fan's cable is nearest the CPU fan connector.

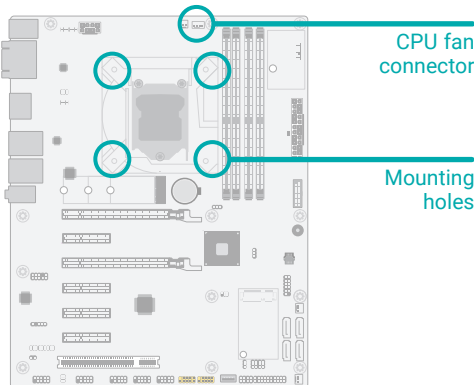

- 4. Screw tight two of the spring screws at opposite corners into the mounting holes. And then proceed with the other two spring screws.

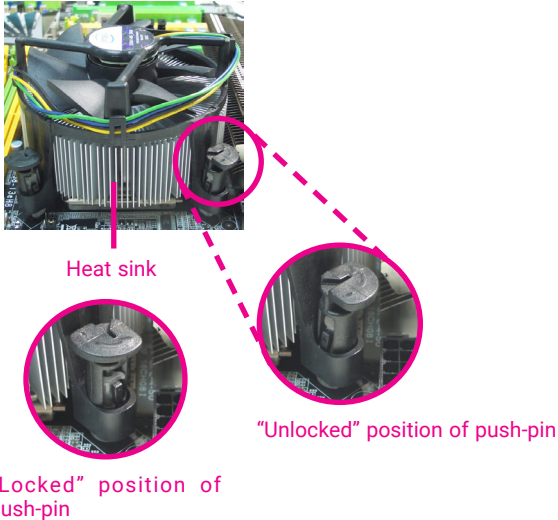

- 5. Connect the CPU fan's cable to the CPU fan connector on the system board.

► **Jumper Settings**

Clear CMOS

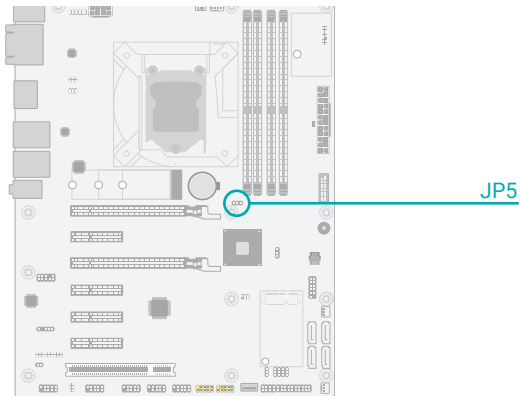

If any anomaly of the followings is encountered –

- a) CMOS data is corrupted;
- b) you forgot the supervisor or user password;
- c) failure to start the system due to BIOS mis-configuration

– it is suggested that the system be reconfigured with default values stored in the ROM BIOS. To load the default values stored in the ROM BIOS, please follow the steps below.

1. Power-off the system and unplug the power cord.
2. Put a jumper cap on pin 2 and pin 3. Wait for a few seconds and set it back to its default setting, i.e. jumper cap on pin 1 and pin 2.
3. Plug the power cord and power-on the system.



■ 1-2 On: Normal (default)



■ 2-3 On: Clear CMOS

COM 1 Serial Mode

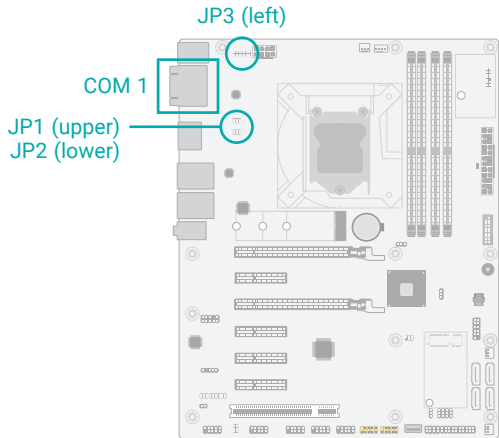

JP1, JP2, and JP3 are used to configure the COM 1 port to RS232, RS422 (Full Duplex) or RS485. The three jumpers must all be configured to the same serial mode.

	RS232 (default)	RS422	RS485
JP3	<p>■ 1-3, 4-6 On</p>	<p>■ 3-5, 4-6 On</p>	<p>■ 3-5, 2-4 On</p>
JP1 & JP2	<p>■ 1-3, 2-4 On</p>	<p>■ 3-5, 4-6 On</p>	<p>■ 3-5, 4-6 On</p>

► Jumper Settings

COM 2 Serial Mode

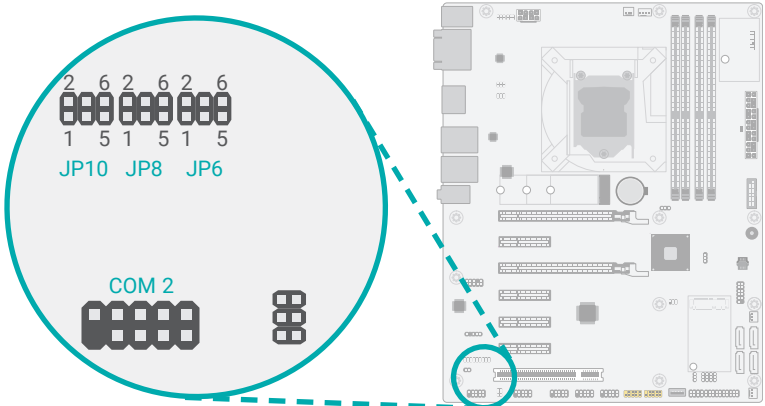

JP6, JP8, and JP10 are used to configure the COM 2 port to RS232, RS422 (Full Duplex) or RS485. The three jumpers must all be configured to the same serial mode.

	RS232 (default)	RS422	RS485
JP10	<p>■ 1-3, 4-6 On</p>	<p>■ 3-5, 4-6 On</p>	<p>■ 3-5, 2-4 On</p>
JP6 & JP8	<p>■ 1-3, 2-4 On</p>	<p>■ 3-5, 4-6 On</p>	<p>■ 3-5, 4-6 On</p>

► Jumper Settings

COM 1/2 RS232 Power Select

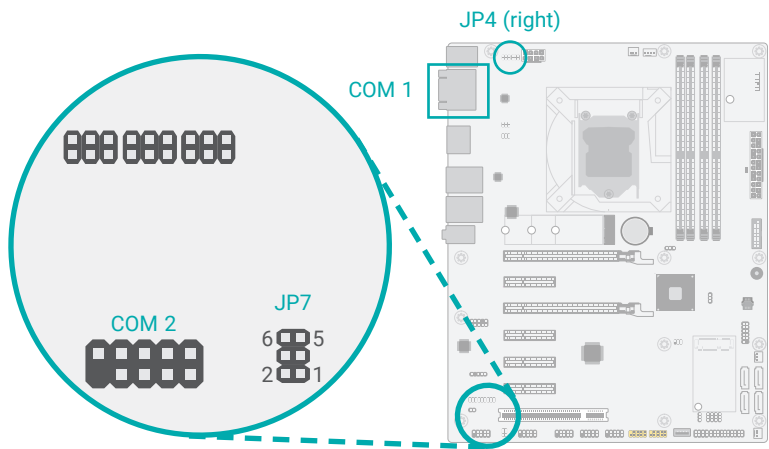

The COM 1 and COM 2 serial ports support RS232 with or without power configured via jumper settings of JP4 and JP7.

	Standard RS232 (default)	RS232 with Power
JP7 (COM2)	<p>■ 2-4 On: Pin 1 = DCD- 1-3 On: Pin 9 = RI-</p>	<p>■ 4-6 On: Pin 1 = +12V 3-5 On: Pin 9 = +5V</p>
JP4 (COM1)		



▶ Jumper Settings

Mini PCIe Signal Select

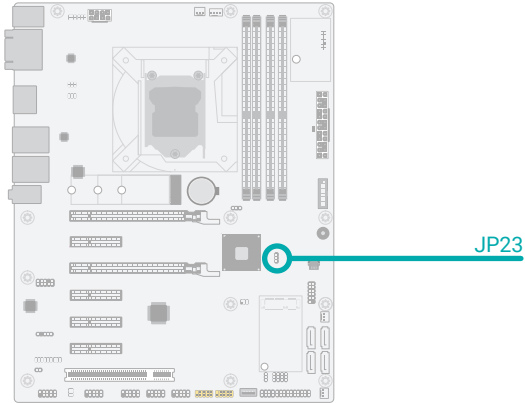

The signal of Mini PCIe can be switched between SATA (default) or PCIe via JP23. When SATA bus is selected, please further decide whether it is directed to the Mini PCIe connector (mSATA signal) or the 7-pin SATA connector, SATA 3 (R5).



■ 1-2 On: SATA bus (default)



■ 2-3 On: PCIe bus

▶ Jumper Settings

SATA Terminal Select

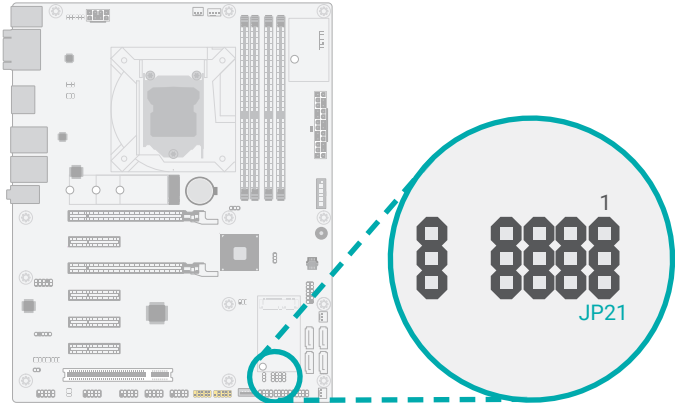

The Mini PCIe bus is shared by a SATA bus and a PCIe bus. When set to SATA bus via JP23 as previously instructed, this SATA bus can further be directed to either the 7-pin SATA connector, SATA3 (R5) or the Mini PCIe connector (mSATA signal) via JP21.



■ 1-2 On: SATA3 (Default)



■ 2-3 On: Mini PCIe/mSATA

▶ Jumper Settings

Mini PCIe Power Select

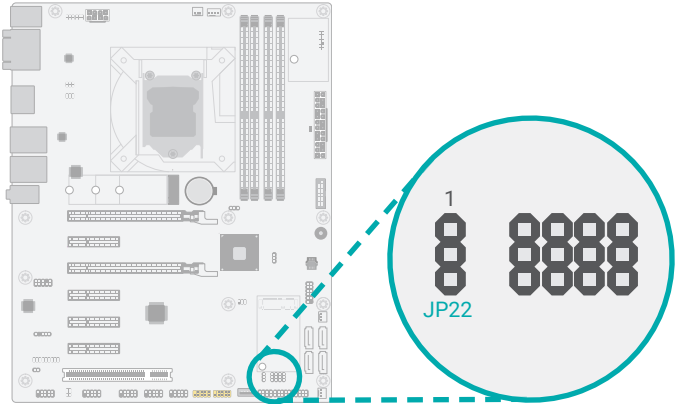

The power of Mini PCIe can be switched between 3V3DU and 3V3 via JP22.

- 

■ 1-2 On: 3V3DU
- 

■ 2-3 On: 3V3 (default)

▶ Jumper Settings

Digital I/O (DIO) Power Supply

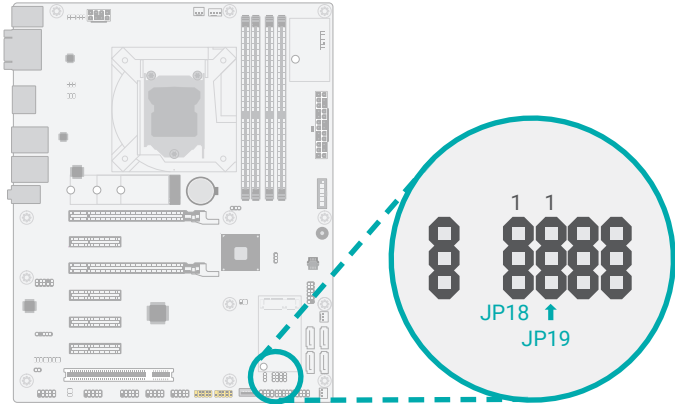

The Digital I/O can be configured to use the power bus of the Digital I/O connector for power supply or not. JP18 is used to select for DIO0~DIO3. JP19 is used to select for DIO4~DIO7.

- 

■ 1-2 On: DIO power used (default)
- 

■ 2-3 On: GND

► Jumper Settings

Digital I/O (DIO) Power Select

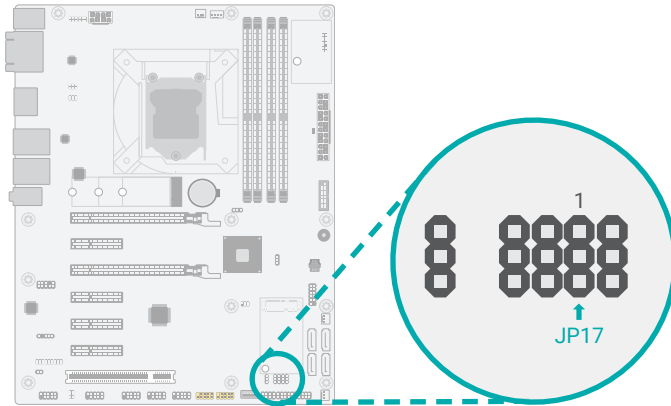

JP17 is used to select the power of Digital I/O: +5V<sub>DU</sub> (default) or +5V.



■ 1-2 On: +5V<sub>DU</sub> (default)



■ 2-3 On: +5V

► Rear I/O Ports

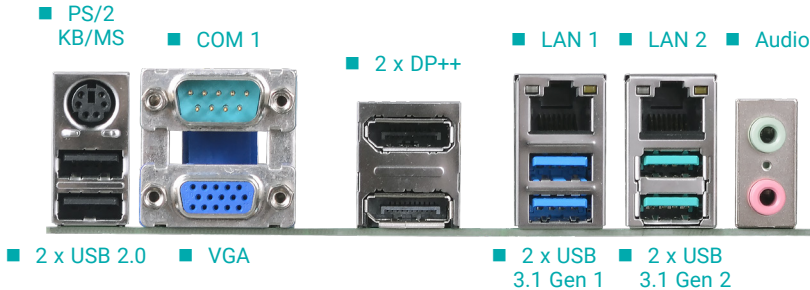

► Rear I/O Ports

PS/2 Keyboard/Mouse

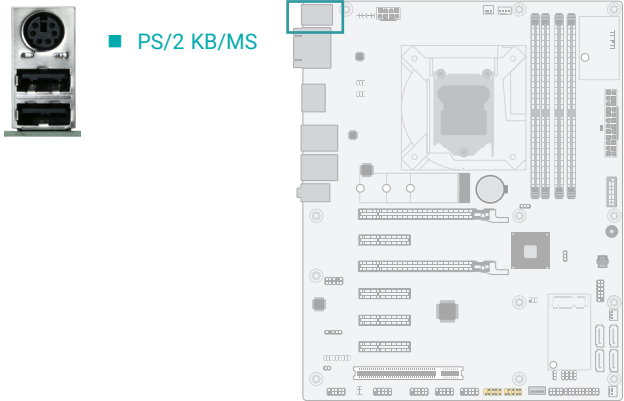

The rear panel I/O ports consist of the following:

- 1 PS/2 Keyboard/Mouse port
- 2 USB 2.0 ports
- 1 Serial COM port (DB9)
- 1 VGA port (DB15)
- 2 DP++ ports
- 2 LAN ports (RJ45 )
- 2 USB 3.1 Gen1 ports
- 2 USB 3.1 Gen2 ports
- 1 Line-in jack (optional)
- 1 Line-out jack
- 1 Mic-in jack

This rear I/O port is used to connect a PS/2 keyboard/mouse. IRQ12 is reserved for the PS/2 mouse connector.

▶ Rear I/O Ports

USB Ports

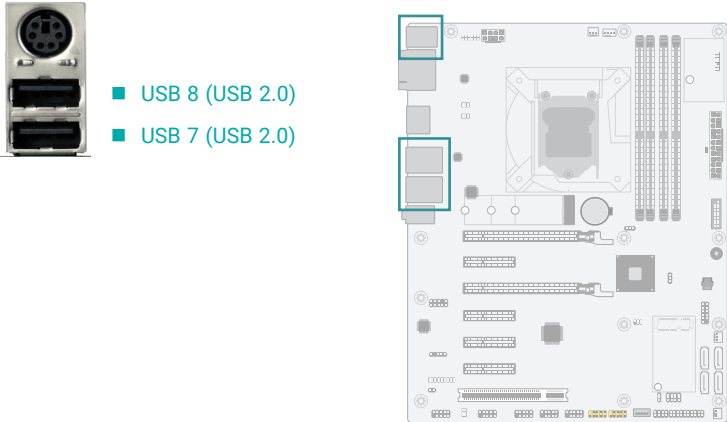

- USB 2 (USB 3.1 Gen 1)
- USB 1 (USB 3.1 Gen 1)



- USB 4 (USB 3.1 Gen 2)
- USB 3 (USB 3.1 Gen 2)

USB allows data exchange between your computer and a wide range of simultaneously accessible external Plug and Play peripherals. The system board is equipped with multiple USB Type A ports at the rear side – two USB 2.0 ports, two USB 3.1 Gen1 ports, and two USB 3.1 Gen2 ports. For the internal USB ports, please refer to the next section. Please refer to the next section for internal USB connectors.

BIOS Setting

Configure the onboard USB in the Advanced menu (“USB Configuration” submenu) of the BIOS. Refer to chapter 3 for more information.

Wake-On-USB Keyboard/Mouse

The Wake-On-USB Keyboard/Mouse function allows you to use a USB keyboard or USB mouse to wake up a system from the S3 (STR - Suspend To RAM) state.

▶ Rear I/O Ports

Graphics Display

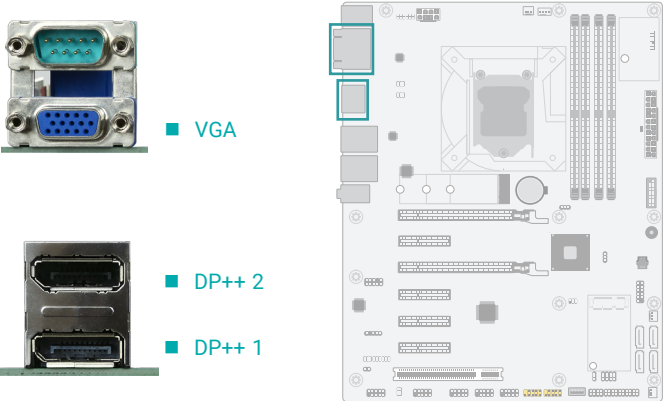

VGA

The VGA port is used for connecting a VGA monitor. Connect the monitor’s 15-pin D-shell cable connector to the VGA port. After you plug the monitor’s cable connector into the VGA port, gently tighten the cable screws to hold the connector in place.

DisplayPort ++

The DisplayPort (DP) is a digital display interface used to connect a display device such as a computer monitor. It is used to transmit audio and video simultaneously. The interface, which is developed by VESA, delivers higher performance features than any other digital interface. DP++ is supported by the system board for converting to DVI and HDMI signals.

BIOS Setting

Configure the display devices in the advanced menu (“Video Configuration” submenu) of the BIOS. Refer to the chapter 3 for more information.

Driver Installation

Install the graphics driver. Refer to the chapter 4 for more information.

▶ Rear I/O Ports

RJ45 LAN

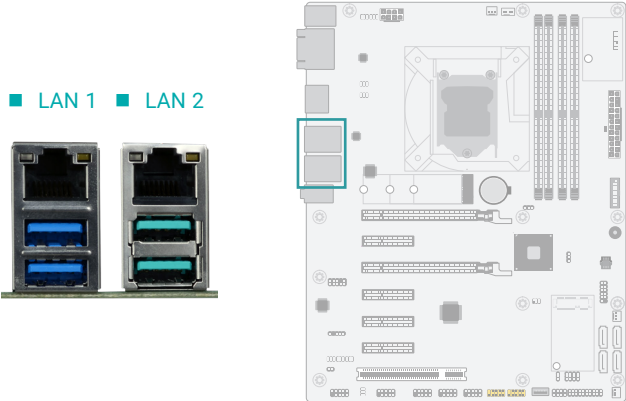

The two LAN ports allow the system board to connect to a local area network.

BIOS Setting

Configure the onboard LAN ports in the Advanced menu ("ACPI Configuration" submenu) of the BIOS. Refer to the chapter 3 for more information.

Driver Installation

Install the LAN drivers. Refer to the chapter 4 for more information.

Features

- 1 Intel® I210AT PCIe Gigabit Ethernet LAN Controller
- 1 Intel® I219LM LAN PHY with iAMT12.0 (only Xeon/Core i7/i5 supports iAMT)

▶ Rear I/O Ports

Audio

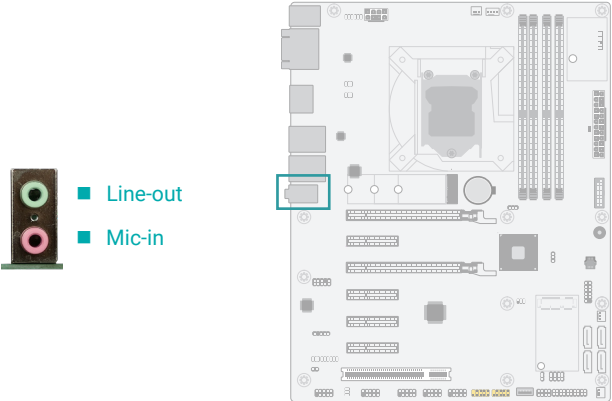

The system board is equipped with three rear audio jacks:

- Line-in Jack (Light Blue), optional  
This jack is used to connect any audio devices such as Hi-fi set, CD player, tape player, AM/FM radio tuner, synthesizer, etc.
- Line-out Jack (Lime)  
This jack is used to connect a headphone or external speakers.
- Mic-in Jack (Pink)  
This jack is used to connect an external microphone.

For the internal Front Audio connector, please refer to the next section.

BIOS Setting

Configure the onboard audio port in the Advanced menu ("Audio Configuration" submenu) of the BIOS. Refer to chapter 3 for more information.

Driver Installation

Install the audio driver. Refer to Chapter 4 for more information.

► Rear I/O Ports

COM 1 (Serial) Port

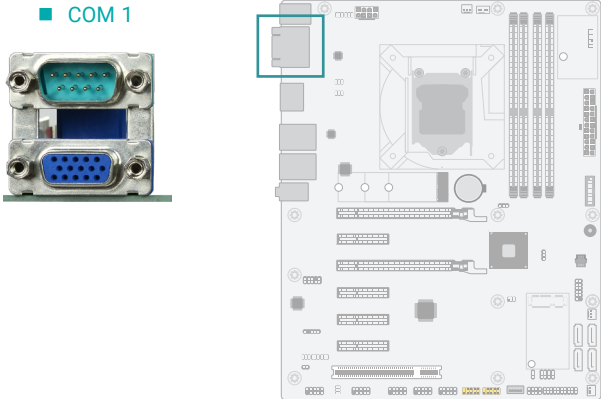

The serial ports are asynchronous communication ports with 16C550A-compatible UARTs that can be used with modems, serial printers, remote display terminals, and other serial devices.

COM 1 supports three serial modes, i.e. RS232, RS422, and RS485, as well as RS232 with/without power.

**Jumper Setting**

Serial mode and RS232 with/without power of COM 1 are configured via jumper settings as previously instructed in this chapter.

**BIOS Setting**

Configure the onboard COM ports in the Advanced menu ("Console Redirection" and "SIO NU-VOTON6116D" submenus) of the BIOS. Refer to chapter 3 for more information.



**Note:** Please refer to the Internal I/O section later in this chapter for more information on the internal COM ports.

► Internal I/O Connectors

COM (Serial) Ports

■ COM 2/3/4/5/6 from left to right

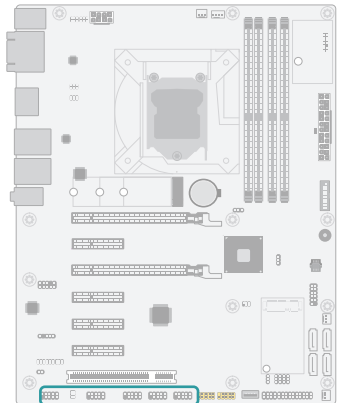

The serial ports are asynchronous communication ports with 16C550A-compatible UARTs that can be used with modems, serial printers, remote display terminals, and other serial devices.

Four of the internal COM (serial) ports, i.e. COM 3/4/5/6, support only RS232 serial mode, while COM 2 supports RS232, RS422, and RS485, as well as RS232 with/without power.

**BIOS Setting**

Configure the onboard COM ports in the Advanced menu ("Console Redirection" and "SIO NU-VOTON6116D" submenus) of the BIOS. Refer to chapter 3 for more information.

**Jumper Setting**

Serial mode and RS232 with/without power of COM 2 are configured via jumper settings as previously instructed in this chapter.

Internal COM Port Pin Assdignment

Pin	Standard RS232	RS232 with Power (COM 2 only)	RS422 (COM 2 only)	RS485 (COM 2 only)
1	DCD-	+12V	RXD+	Data+
2	RD	RD	RXD-	Data-
3	TD	TD	TXD+	N.C.
4	DTR-	DTR-	TXD-	N.C.
5	GND	GND	GND	GND
6	DSR-	DSR-	N.C.	N.C.
7	RTS-	RTS-	N.C.	N.C.
8	CTS-	CTS-	N.C.	N.C.
9	RI-	+5V	N.C.	N.C.

USB Ports

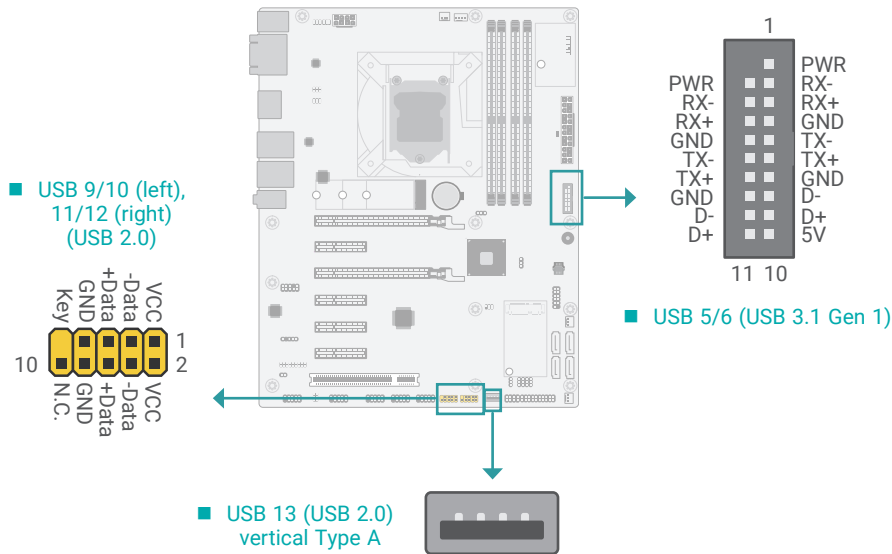

The USB device allows data exchange between your computer and a wide range of simultaneously accessible external Plug and Play peripherals.

In addition to the rear USB ports as introduced previously in this chapter, the system board is equipped with five internal USB 2.0 ports and 2 USB 3.1 Gen 1 ports as illustrated above.

The internal USB pin headers may be connected to a card-edge bracket. Install the card-edge bracket to an available slot at the rear of the system chassis and then insert the USB port cables to a connector. The Part Number of the 20-pin USB 3.1 connector is 346-521081-200G. Please contact our sales representatives for more information if the cable is to be customized.

**BIOS Setting**

Configure the onboard USB in the Advanced menu (“USB Configuration” submenu) of the BIOS. Refer to chapter 3 for more information.

**Wake-On-USB Keyboard/Mouse**

The Wake-On-USB Keyboard/Mouse function allows you to use a USB keyboard or USB mouse to wake up a system from the S state(s).

**Note:**  
The pin headers for USB 2.0 ports (USB 11/12) can be optionally replaced by a USB 2.0 Type A port by request.



Internal I/O Connectors

Front Audio

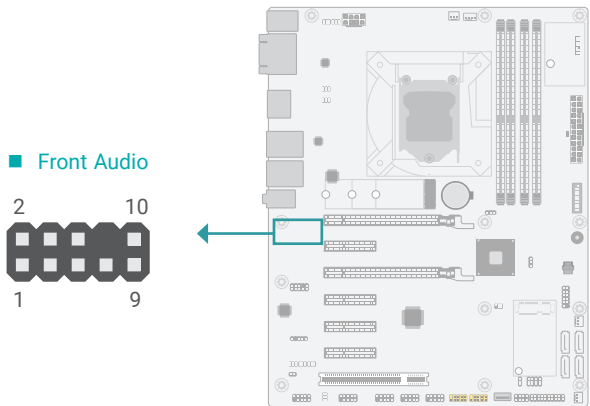

The Front Audio internal connector allows you to connect to the second line-out and mic-in jacks that are at the front panel of your system.

Front Audio Pin Assignment

Pin	Assignment	Pin	Assignment
1	Mic-L	2	GND
3	Mic-R	4	N.C.
5	Line-Out-R	6	Mic-JD (sense)
7	GND	8	KEY
9	Line-Out-L	10	Line-JD (sense)

Internal I/O Connectors

SATA (Serial ATA)

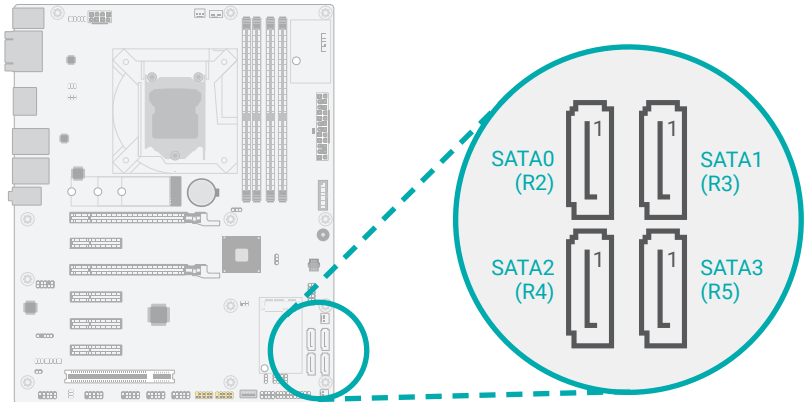

The Serial ATA (SATA) connectors are used to connect the Serial ATA device. SATA 3.0 is supported by the five SATA ports and provides data rate up to 6Gb/s. Connect one end of the Serial ATA cable to a SATA connector and the other end to your Serial ATA device.

BIOS Setting

Configure the Serial ATA drives in the Advanced menu ("SATA Configuration" submenu) of the BIOS. Refer to chapter 3 for more information.

Jumper Setting

A SATA bus is either terminated at SATA3 (R5) or Mini PCIe (mSATA), and is configured via JP23 and JP21 as previously instructed in this chapter.

SATA Pin Assignment

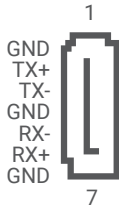

**Note:** The SATA bus of SATA3 (R5) is shared with Mini PCIe (mSATA), and will be inactive when the SATA bus is directed to Mini PCIe (mSATA).

Internal I/O Connectors

Digital I/O

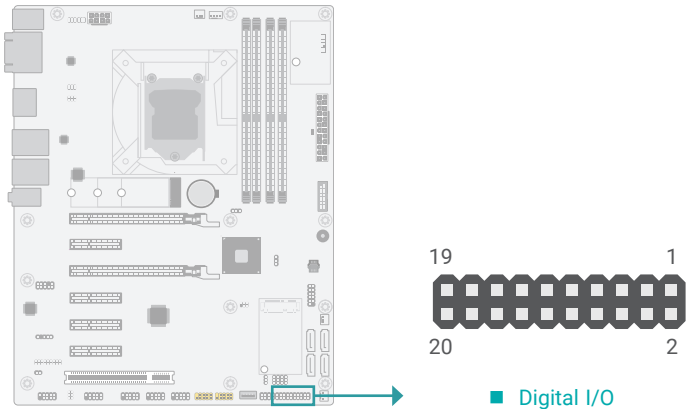

The 8-bit Digital I/O (DIO) connector allows for input/output signals of digital logical states defined by voltage levels.

Jumper Setting

DIO signal and power can be configured via jumper settings as previously instructed in this chapter.

Digital I/O Pin Assignment

Pin	Assignment	Pin	Assignment
1	GND	2	+12V
3	DIO_7	4	+12V
5	DIO_6	6	GND
7	DIO_5	8	+5V
9	DIO_4	10	+5V
11	DIO_3	12	GND
13	DIO_2	14	+5V <sub>DU</sub>
15	DIO_1	16	+5V <sub>DU</sub>
17	DIO_0	18	GND
19	GND	20	---

Internal I/O Connectors

Cooling Fan Connectors

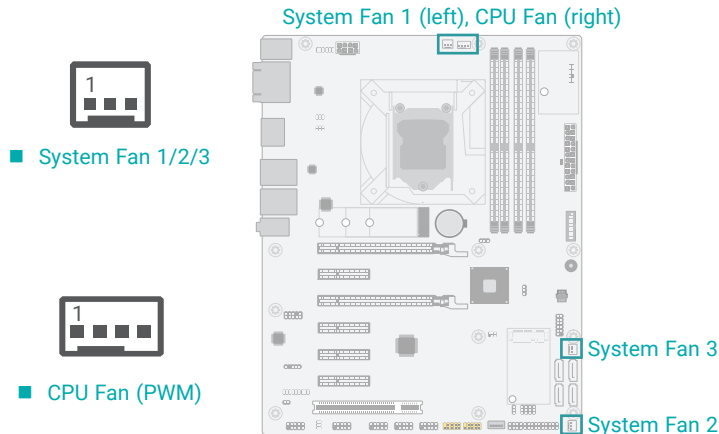

These fan connectors are used to connect to cooling fans. Cooling fans provide adequate air circulation throughout the chassis and dissipate heat to prevent overheating of the system board and components. The 4-pin fan provides PWM to modulate fan speed whereas the 3-pin fans modulate fan speed via voltage modulation.

BIOS Setting

Configure the Smart Fans in the Advanced menu ("SIO NUVOTON6116D" submenu) of the BIOS. Refer to chapter 3 for more information.

3-pin Fan Pin Assignment

Pin	Assignment
1	Ground
2	Power
3	Sense

4-pin Fan Pin Assignment

Pin	Assignment
1	Ground
2	Power
3	Sense
4	Speed Control

Internal I/O Connectors

Power Connector

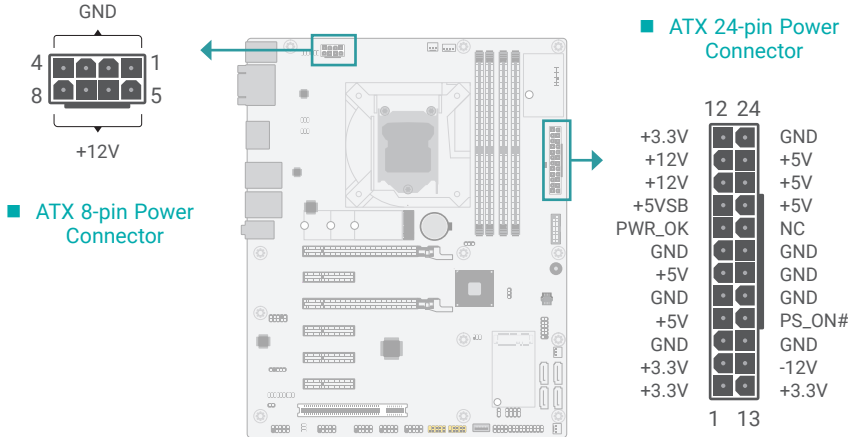

Use a power supply that complies with the ATX12V Power Supply Design Guide Version 1.1. An ATX12V power supply unit has a standard 24-pin ATX main power connector that must be inserted into the 24-pin connector. The 8-pin +12V power connector enables the delivery of more +12VDC current to the processor's Voltage Regulator Module (VRM). The power connectors from the power supply unit are designed to fit the 24-pin and 8-pin connectors in only one orientation. Make sure to find the proper orientation before plugging the connectors.

The system board requires a minimum of 300 Watt power supply to operate. Your system configuration (CPU power, amount of memory, add-in cards, peripherals, etc.) may exceed the minimum power requirement. To ensure that adequate power is provided, we strongly recommend that the system is supplied with a minimum of 400 Watt power.



**Important:** Insufficient power supplied to the system may result in instability or malfunction of the add-in boards and peripherals. Calculating the system's approximate power usage is important to ensure that the power supply meets the system's consumption requirements.

Internal I/O Connectors

Chassis Intrusion

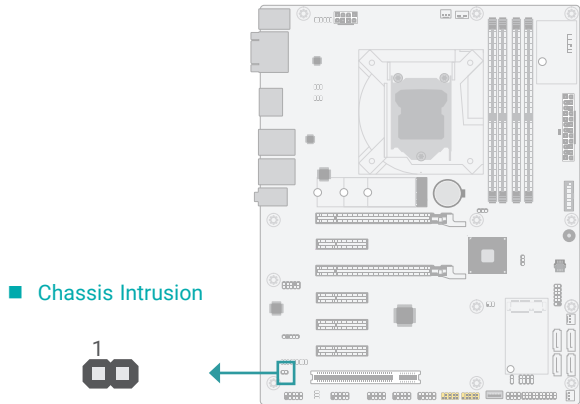

The board supports the chassis intrusion detection function. Connect the chassis intrusion sensor cable from the chassis to this connector. When the system's power is on and a chassis intrusion occurred, an alarm will sound. When the system's power is off and a chassis intrusion occurred, the alarm will sound only when the system restarts.

Chassis Intrusion Pin Assignment

Pin	Assignment	Pin	Assignment
1	Signal	2	GND

Internal I/O Connectors

Front Panel

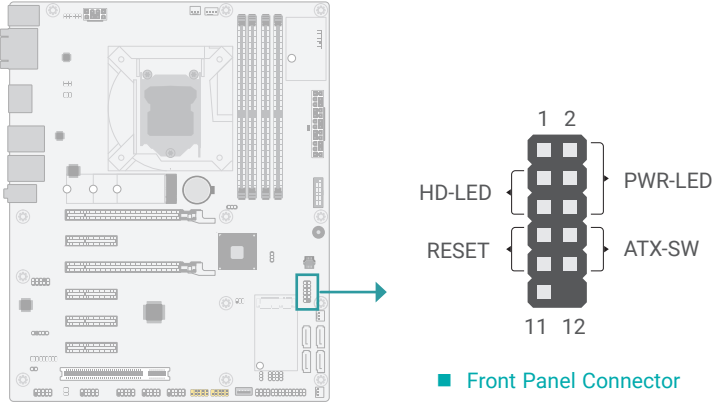

Front Panel Pin Assignment

Pin	Assignment	Pin	Assignment	
1	N.C.	2	LED Power	
3	HDD Power	PWR-LED	4	LED Power
HD-LED	5	Signal	6	Signal
7	Ground	ATX-SW	8	Ground
RESET	9	Signal	10	Signal
11	N.C.	12	---	

HDD-LED - Hard Disk Drive LED

Lighting of the LED indicates that the hard drive is being accessed.

RESET - Reset Switch

This switch allows you to reboot without having to power off the system.

PWR-LED - Power/Standby LED

When the system's power is on, this LED will light up. When the system is in the S1 (POS - Power On Suspend) state, it will blink at 1-second intervals. When the system is in the S3 (STR - Suspend To RAM) state, it will blink at 4-second intervals.

ATX-SW - ATX Power Switch

This switch is used to power on or off the system.

Internal I/O Connectors

S/PDIF

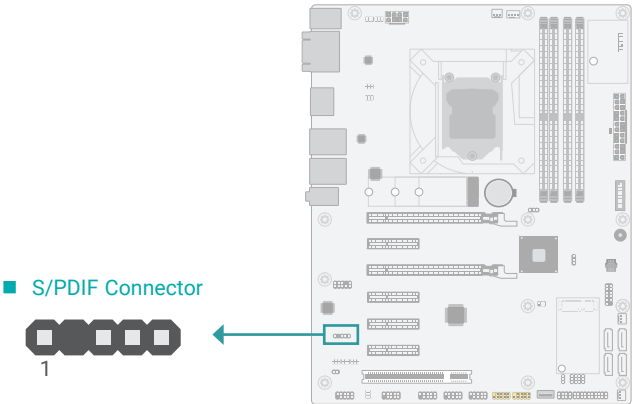

The Sony/Philips Digital Interface (S/PDIF) connector is for audio output to external audio equipment. The S/PDIF port may be mounted on a card-edge bracket. Install the card-edge bracket to an available slot at the rear of the system chassis then connect the audio cable to the S/PDIF connector. Make sure pin 1 of the audio cable is aligned with pin 1 of the S/PDIF connector.

S/PDIF Pin Assignment

Pin	Assignment
1	+5V
2	---
3	SPDIF Out
4	GND
5	SPDIF In

Internal I/O Connectors

Battery

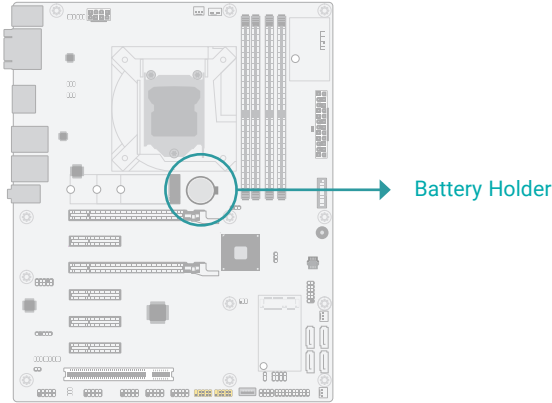

The lithium ion battery addendum supplies power to the real-time clock and CMOS memory as an auxiliary source of power when the main power is shut off. Insert a coin cell battery into the holder and make sure the polarities are correctly oriented – the cap side (rimmed rounded edge) is negative and should be facing the holder; the flat side with a + mark is positive and should be facing away from the holder.

Safety Measures

- There exists explosion hazard if the battery is incorrectly installed.
- Replace only with the same or equivalent type recommended by the manufacturer.
- Dispose of used batteries according to local ordinances.

Internal I/O Connectors

SMBus

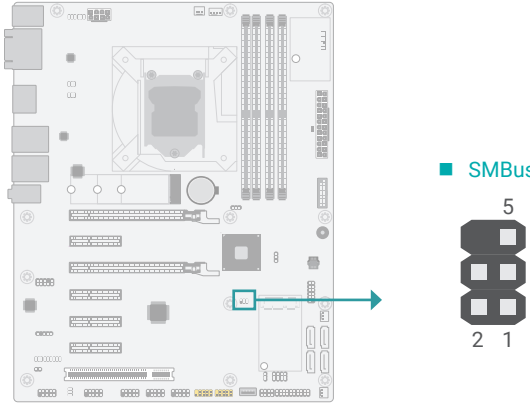

The SMBus (System Management Bus) connector is used to connect the SMBus device. It is a multiple device bus that allows multiple chips to connect to the same bus and enable each one to act as a master by initiating data transfer.

SMBus Pin Assignment

Pin	Assignment	Pin	Assignment
1	3V3SB	2	GND
3	SMBus_Clock	4	SMBus_DATA
5	SMBus_Alert	6	---

Internal I/O Connectors

LPC

The LPC connector is used for debugging.

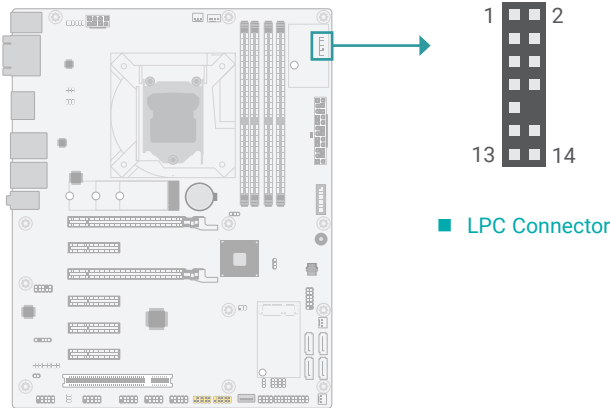

LPC Connector

LPC Pin Assignment

Pin	Assignment	Pin	Assignment
1	L_CLK	2	L_LAD1
3	L_RST#	4	L_LAD0
5	L_FRAME#	6	3.3V
7	L_LAD3	8	GND
9	L_LAD2	10	---
11	SERIRQ	12	GND
13	5VSB	14	5V

Internal I/O Connectors ▶ LPC

External COM port Module

The external COM port modules – EXT-RS232 and EXT-RS485 – are designed by DFI's proprietary technology, and support four additional COM ports per module. The EXT-RS232/RS485 card is connected to the motherboard via the LPC connector and secured by a standoff as illustrated below.

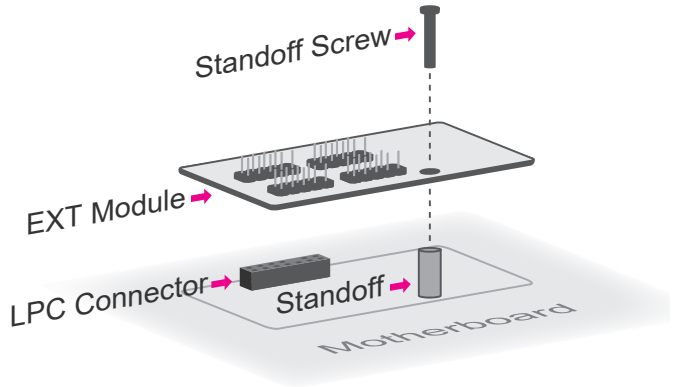
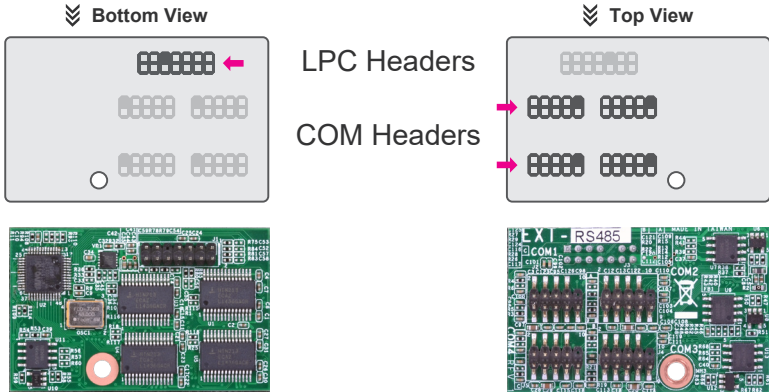

**Note:** The EXT-RS232/RS485 modules are optional peripherals that are not included in the standard package. For more information, please contact DFI sales representatives or visit [go.dfi.com/EXT-RS232](http://go.dfi.com/EXT-RS232), and [go.dfi.com/EXT-RS485](http://go.dfi.com/EXT-RS485).

Internal I/O Connectors

LAN LED

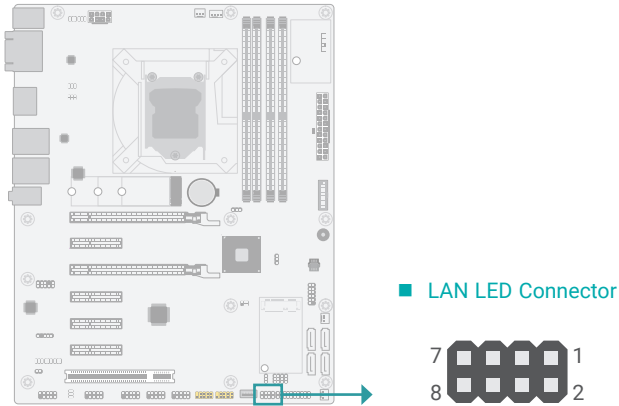

The LAN LED connector is used to detect the connection state of RJ45 LAN ports when the connection is made to an active network via a cable. The pin functions of the LAN LED connector are listed below.

LAN LED Pin Assignment

Pin	Assignment	Pin	Assignment
1	GBE(LAN1)_1000	2	GBE(LAN1)_100
3	GBE(LAN1)_LED_LINK_ACT	4	3V3DU
5	LINK(LAN2)_1000	6	LINK(LAN2)_100
7	LINK(LAN2)_ACTIVITY	8	3V3DU

Internal I/O Connectors

Expansion Slots

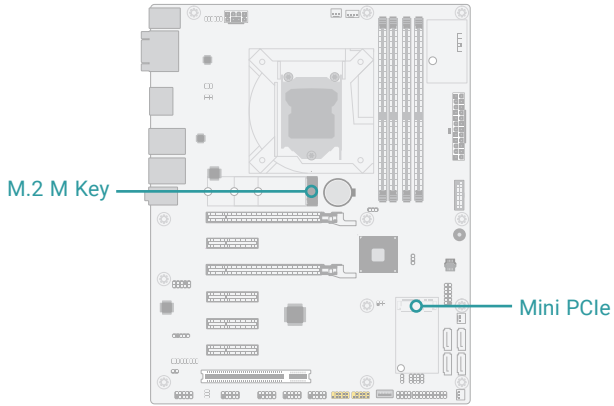

M.2 Sockets

The M.2 socket is the Next Generation Form Factor (NGFF) which is designed to support multiple modules and make the M.2 more suitable in application for solid-state storage. The board preserves space for the M.2 M key socket (22mm x 42mm, 22mm x 60mm, and 22mm x 80mm).

Mini PCIe

The Mini PCIe socket allows for a full-size Mini PCIe module. The Mini PCIe supports PCIe, SATA, and USB signals.

BIOS Setting

Configure PCIe root ports in the Advanced menu ("PCI Express Configuration" submenu) of the BIOS. Refer to chapter 3 for more information.

Jumper Setting

Select the signal of Mini PCIe via jumper settings as previously instructed in this chapter.

Installing the M.2 Module

Before installing the M.2 module into the M.2 socket, please make sure that the following safety cautions are well-attended.

1. Make sure the PC and all other peripheral devices connected to it has been powered down.
2. Disconnect all power cords and cables.
3. Locate the M.2 socket on the system board
4. Make sure the notch on card is aligned to the key on the socket.
5. Make sure the standoff screw is removed from the standoff.

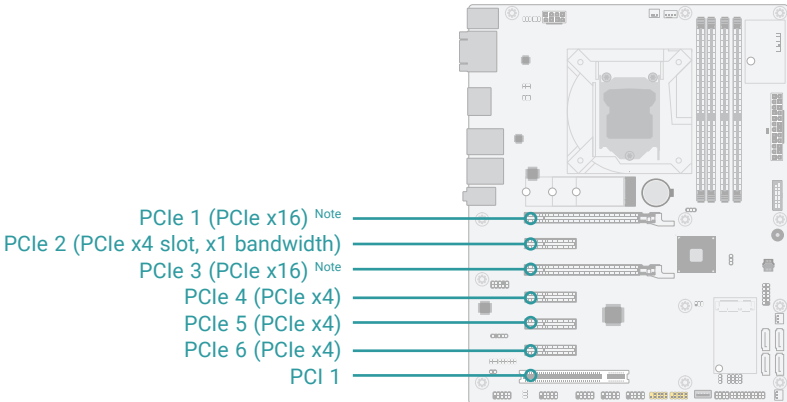

PCI Express x16 Slot

Install a PCI Express x16 graphics card that complies to the PCI Express specifications into the PCI Express x16 slot. To install a graphics card into the x16 slot, align the graphics card to the socket and perpendicularly to the board, be cautious in aligning the locations of notch and key, and then press the card down firmly until it is completely seated. The retaining clip of the slot will close up automatically to hold the graphics card in place.

PCI Express x4 Slot

Install PCI Express cards such as network cards or other cards that comply to the PCI Express specifications into the PCI Express x4 slot.

PCI Slot

The two PCI slots support expansion cards that comply with PCI specifications. You can install a PCI expansion card or a customized riser card designed for only 2 PCI slots expansion (for low profile PCI card only) into the PCI slot.

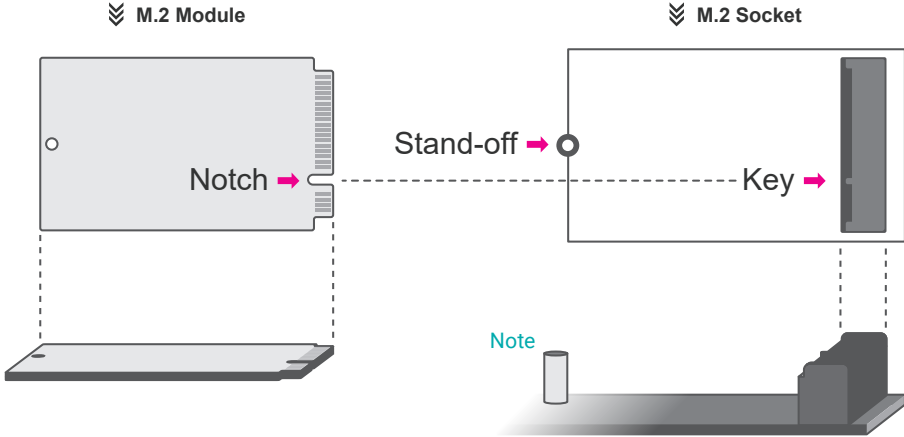

**Note:** The PCIe x16 slots share one x16 bandwidth in the following manners: PCIe 1 is x16 bandwidth when PCIe 3 is unused; when PCIe 3 is in used, both PCIe 1 and PCIe 3 are x8 bandwidth.



**Note:** The M.2 stand-off (M2X4, M2.5x4.5) is detachable and is screwed onto one of the reserved bases for the three supported form factors. Please remove and install it into the base of the form factor that matches the M.2 module to be installed.



Please follow the steps below to install the card into the socket.

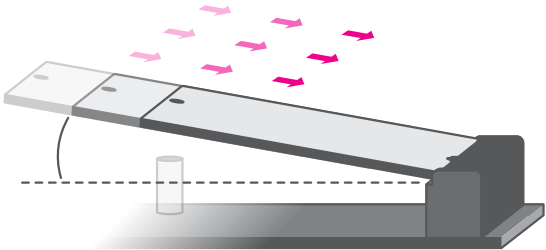

**Step 1:**  
Insert the card into the socket at an angle while making sure the notch and key are perfectly aligned.

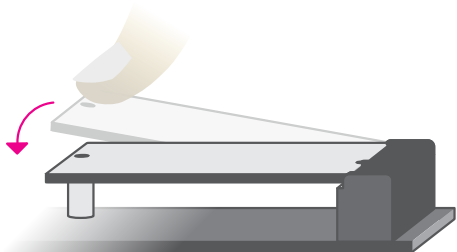

**Step 2:**  
Press the end of the card far from the socket down until against the stand-off.

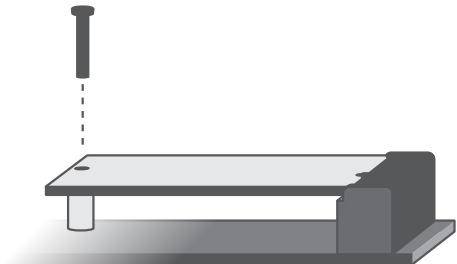

**Step 3:**  
Screw tight the card onto the stand-off with a screw driver and a stand-off screw until the gap between the card and the stand-off closes up. The card should be lying parallel to the board when it's correctly mounted.

### Installing the Mini PCIe Module

Before installing the Mini PCIe module into the Mini PCIe socket, please make sure that the following safety cautions are well-attended.

1. Make sure the PC and all other peripheral devices connected to it has been powered down.
2. Disconnect all power cords and cables.
3. Locate the Mini PCIe socket on the system board
4. Make sure the notch on card is aligned to the key on the socket.

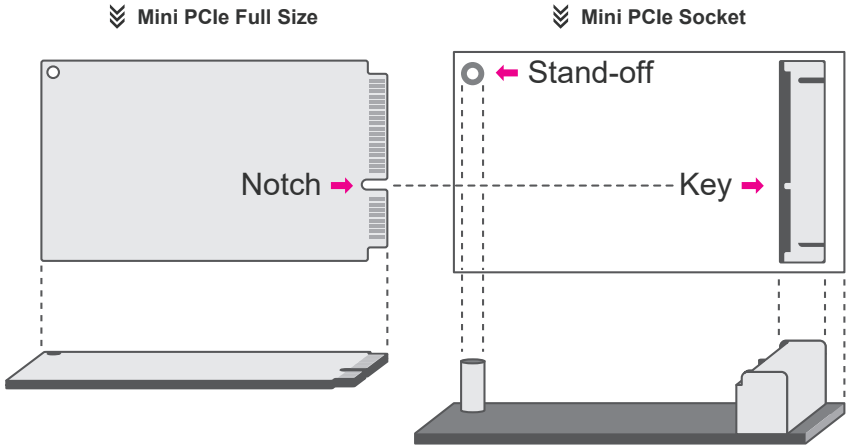

Please follow the steps below to install the card into the socket.

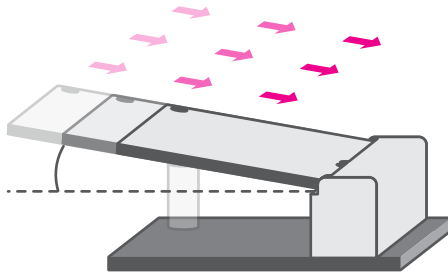

**Step 1:**

Insert the card into the socket at an angle while making sure the notch and key are perfectly aligned.

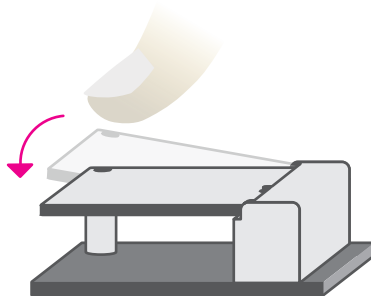

**Step 2:**

Press the end of the card far from the socket down until against the stand-off.

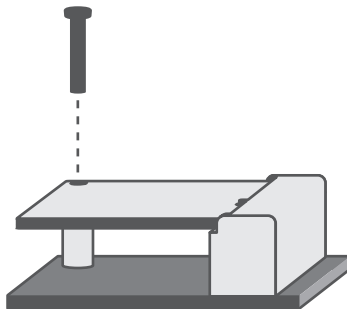

**Step 3:**

Screw tight the card onto the stand-off with a screw driver and a stand-off screw until the gap between the card and the stand-off closes up. The card should be lying parallel to the board when it's correctly mounted.

## Chapter 3 - BIOS Settings

### ► Overview

The BIOS is a program that takes care of the basic level of communication between the CPU and peripherals. It contains codes for various advanced features found in this system board. The BIOS allows you to configure the system and save the configuration in a battery-backed CMOS so that the data retains even when the power is off. In general, the information stored in the CMOS RAM of the EEPROM will stay unchanged unless a configuration change has been made such as a hard drive replaced or a device added. It is possible that the CMOS battery will fail causing CMOS data loss. If this happens, you need to install a new CMOS battery and reconfigure the BIOS settings.



#### Note:

The BIOS is constantly updated to improve the performance of the system board; therefore the BIOS screens in this chapter may not appear the same as the actual one. These screens are for reference purpose only.

#### Default Configuration

Most of the configuration settings are either predefined according to the Load Optimal Defaults settings which are stored in the BIOS or are automatically detected and configured without requiring any actions. There are a few settings that you may need to change depending on your system configuration.

#### Entering the BIOS Setup Utility

The BIOS Setup Utility can only be operated from the keyboard and all commands are keyboard commands. The commands are available at the right side of each setup screen. The BIOS Setup Utility does not require an operating system to run. After you power up the system, the BIOS message appears on the screen and the memory count begins. After the memory test, the message "Press DEL to run setup" will appear on the screen. If the message disappears before you respond, restart the system or press the "Reset" button. You may also restart the system by pressing the <Ctrl> <Alt> and <Del> keys simultaneously.

#### Legends

Keys	Function
Right / Left arrow	Move the highlight left or right to select a menu
Up / Down arrow	Move the highlight up or down between submenus or fields
<Enter>	Enter the highlighted submenu
+ (plus key)/F6	Scroll forward through the values or options of the highlighted field
- (minus key)/F5	Scroll backward through the values or options of the highlighted field
<F1>	Display general help
<F2>	Display previous values
<F9>	Optimized defaults
<F10>	Save and Exit
<Esc>	Return to previous menu

#### Scroll Bar

When a scroll bar appears to the right of the setup screen, it indicates that there are more available fields not shown on the screen. Use the up and down arrow keys to scroll through all the available fields.

#### Submenu

When "►" appears on the left of a particular field, it indicates that a submenu which contains additional options are available for that field. To display the submenu, move the highlight to that field and press <Enter>.

► Main

The Main menu is the first screen that you will see when you enter the BIOS Setup Utility.

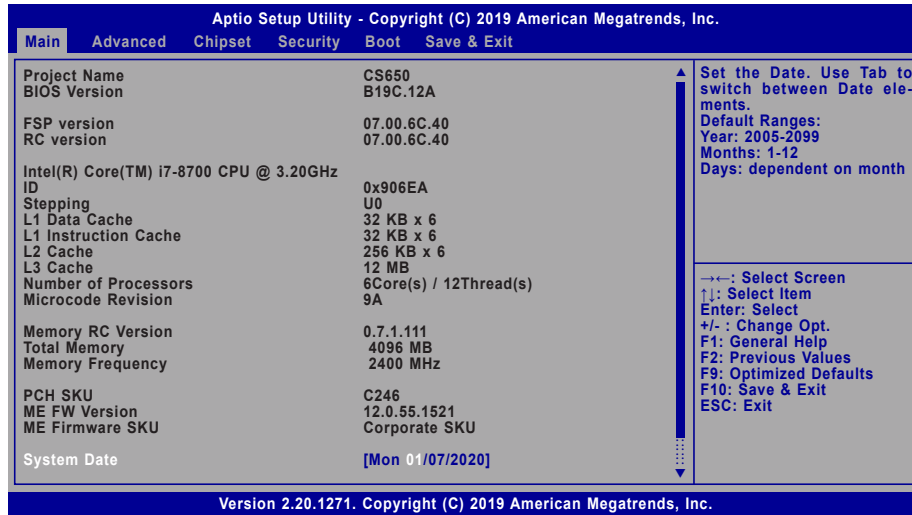

**System Date**

The date format is <month>, <date>, <year>. Press "Tab" to switch to the next field and press "-" or "+" to modify the value.

**System Time**

The time format is <hour>, <minute>, <second>. The time is based on the 24-hour military-time clock. For example, 1 p.m. is 13:00:00. Hour displays hours from 00 to 23. Minute displays minutes from 00 to 59. Second displays seconds from 00 to 59.

► Advanced

The Advanced menu allows you to configure your system for basic operation. Some entries are defaults required by the system board, while others, if enabled, will improve the performance of your system or let you set some features according to your preference.



**Important:**  
Setting incorrect field values may cause the system to malfunction.

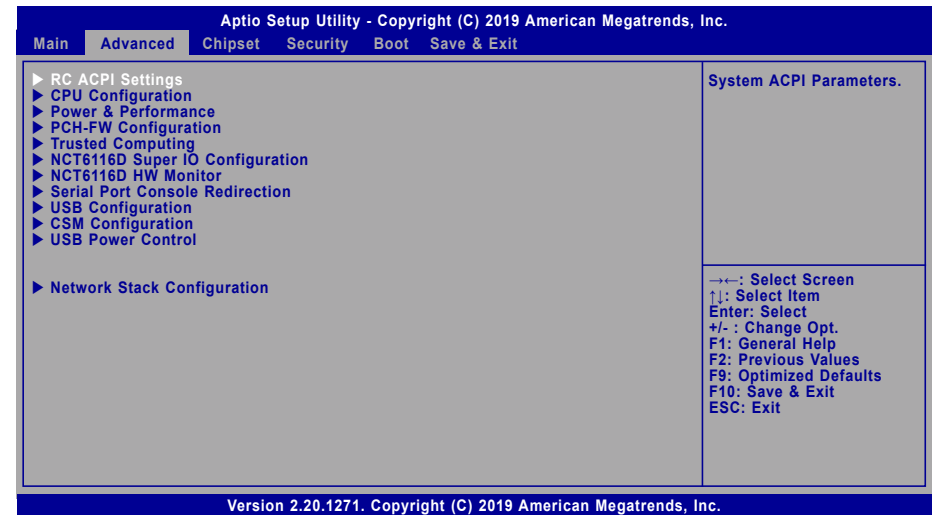

► Advanced

### RC ACPI Configuration

Aptio Setup Utility - Copyright (C) 2019 American Megatrends, Inc.		
Advanced		
<b>RC ACPI Configuration</b>		Enable or disable System wake on alarm event. When enabled, System will wake on the hr:min::sec specified
Wake system from S5	[Enabled]	
Wake up hour	0	→←: Select Screen ↑↓: Select Item Enter: Select +/-: Change Opt. F1: General Help F2: Previous Values F9: Optimized Defaults F10: Save & Exit ESC: Exit
Wake up minute	0	
Wake up second	0	
State After G3	[S0 State]	
Version 2.20.1271. Copyright (C) 2019 American Megatrends, Inc.		

#### Wake system from S5

When Enabled, the system will automatically power up at a designated time every day. Once it's switched to [Enabled], please set up the time of day — hour, minute, and second — for the system to wake up.

#### State After G3

Select between S0 State, and S5 State. This field is used to specify what state the system is set to return to when power is re-applied after a power failure (G3 state).

- S0 State**     The system automatically powers on after power failure.
- S5 State**     The system enter soft-off state after power failure. Power-on signal input is required to power up the system.
- Last State**    The system returns to the last state right before power failure.

► Advanced

### CPU Configuration

Aptio Setup Utility - Copyright (C) 2019 American Megatrends, Inc.		
Advanced		
<b>CPU Configuration</b>		When enabled, a VMM can utilize the additional hardware capabilities provided by Vanderpool Technology.
Intel (VMX) Virtualization Technology	[Enable]	
Active Processor Cores	[All]	→←: Select Screen ↑↓: Select Item Enter: Select +/-: Change Opt. F1: General Help F2: Previous Values F9: Optimized Defaults F10: Save & Exit ESC: Exit
Hyper-Threading	[Enable]	
Version 2.20.1271. Copyright (C) 2019 American Megatrends, Inc.		

#### Intel (VMX) Virtualization Technology

When this field is set to Enabled, the VMM can utilize the additional hardware capabilities provided by Vanderpool Technology.

#### Active Processor Cores

Select number of cores to enable in each processor package: all or 1.

#### Hyper-threading

Enables this field for Windows XP and Linux which are optimized for Hyper-Threading technology. Select disabled for other OSes not optimized for Hyper-Threading technology. When disabled, only one thread per enabled core is enabled.



**Note:**  
Some of the fields may not be available when the features are not supported by the equipped CPU.

▶ Advanced

Power & Performance

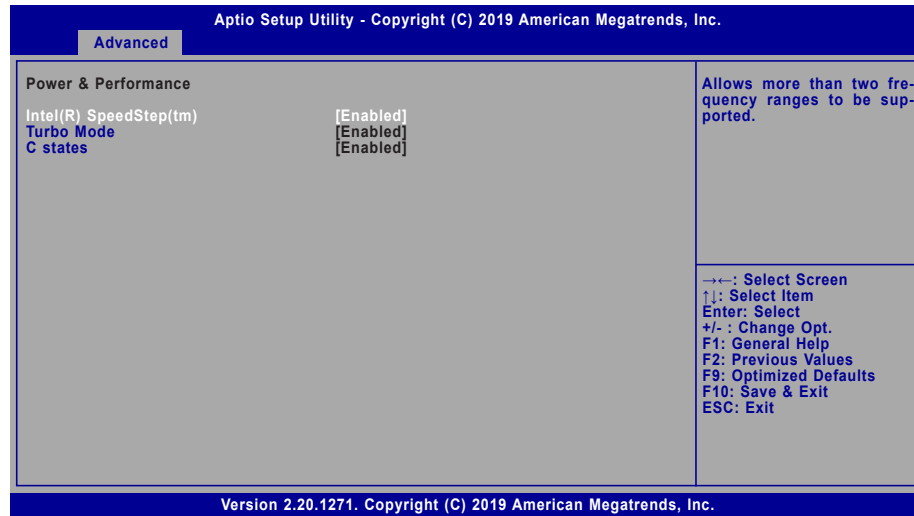

**Intel(R) SpeedStep(tm)**

This field is used to enable or disable the Intel SpeedStep® Technology, which helps optimize the balance between system’s power consumption and performance. After it is enabled in the BIOS, EIST features can then be enabled via the operating system’s power management.

**Turbo Mode**

Enable or disable turbo mode of the processor. This field will only be displayed when EIST is enabled.

**C states**

Enable or disable CPU Power Management. It allows CPU to enter "C states" when it’s idle and nothing is executing.

▶ Advanced

PCH-FW Configuration

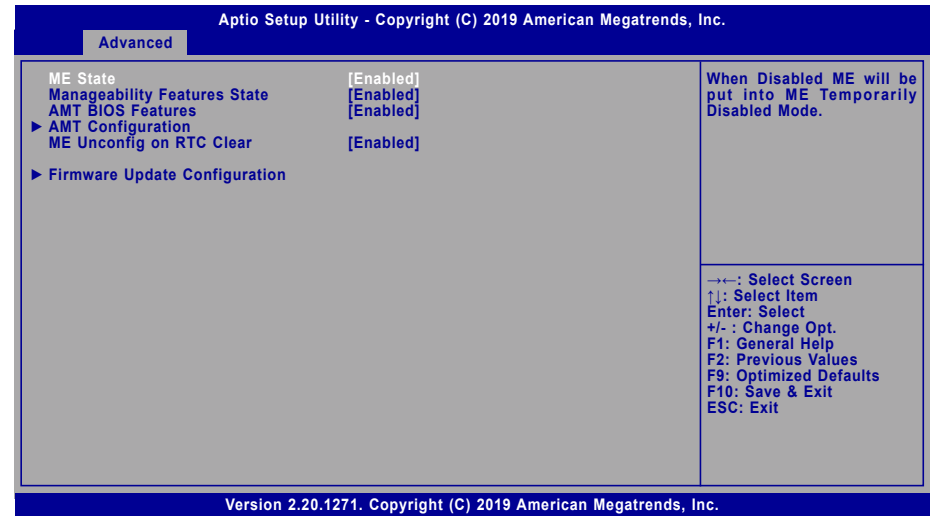

**ME State**

When this field is set to Disabled, ME will be put into ME Temporarily Disabled Mode.

**Manageability Features State**

Enable or disable Intel(R) Manageability features. This option disables/enables Manageability Features support in FW. To disable, support platform must be in an unprovisioned state first.

**AMT BIOS Features**

When disabled, AMT BIOS features are no longer supported and user is no longer able to access MEBx Setup. This option does not disable manageability features in FW.

**ME Unconfig on RTC Clear**

When disabled, ME will not be unconfigured on RTC Clear.



**Note:**  
The sub-menus are detailed in following sections.

▶ Advanced ▶ PCH-FW Configuration

▶ **AMT Configuration**

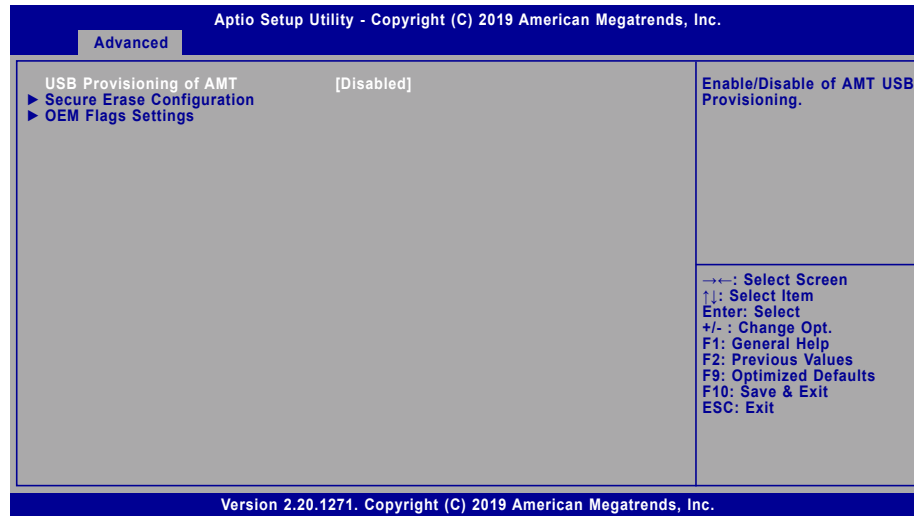

**USB Provisioning of AMT**

Enable or disable AMT USB Provisioning.

▶ Advanced ▶ PCH-FW Configuration

▶ **AMT Configuration** ▶ **Secure Erase Configuration**

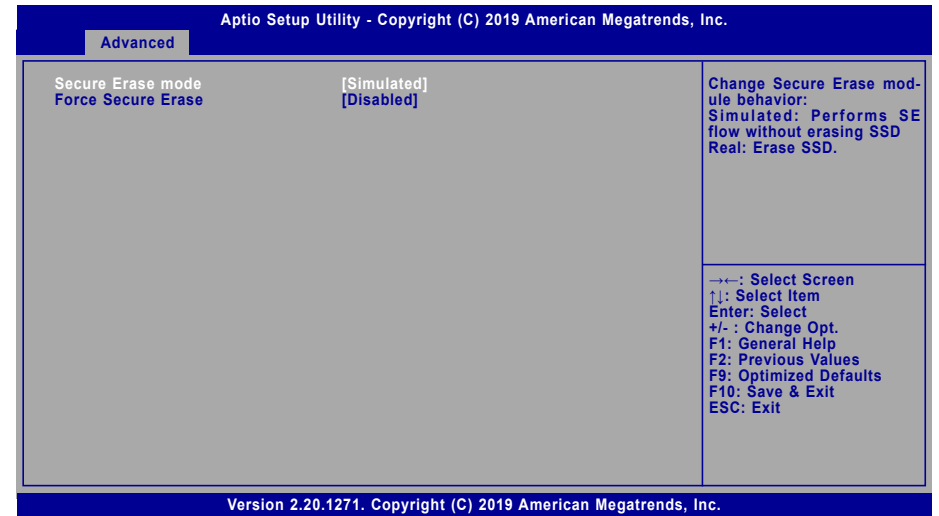

**Secure Erase Mode**

Select Secure Erase module behavior: Simulated or Real.

**Force Secure Erase**

Enable or disable Force Secure Erase on next boot.

▶ Advanced ▶ PCH-FW Configuration

▶ AMT Configuration ▶ OEM Flags Settings

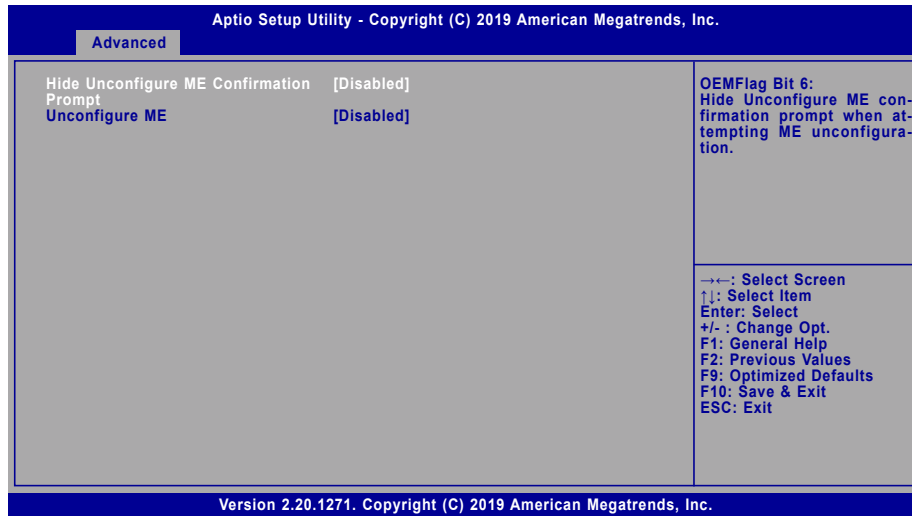

**Hide Unconfigure ME Confirmation Prompt**

Enable or disable to hide unconfigure ME confirmation prompt when attempting ME unconfiguration.

**Unconfigure ME**

Enable or disable to unconfigure ME with resetting MEBx password to default.

▶ Advanced ▶ PCH-FW Configuration

▶ Firmware Update Configuration

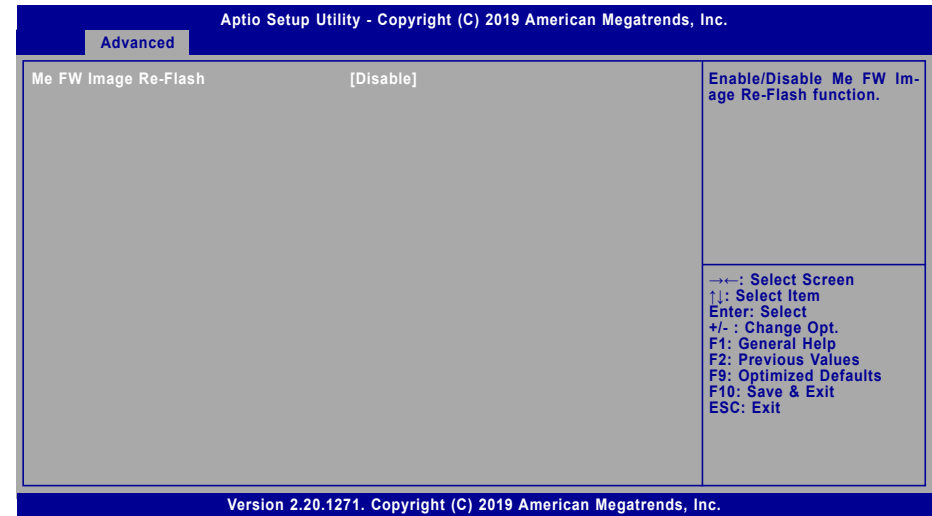

**Me FW Image Re-Flash**

This field is used to enable or disable the ME FW Image Re-Flash function, which allows the user to update the ME firmware.



▶ Advanced

Trusted Computing

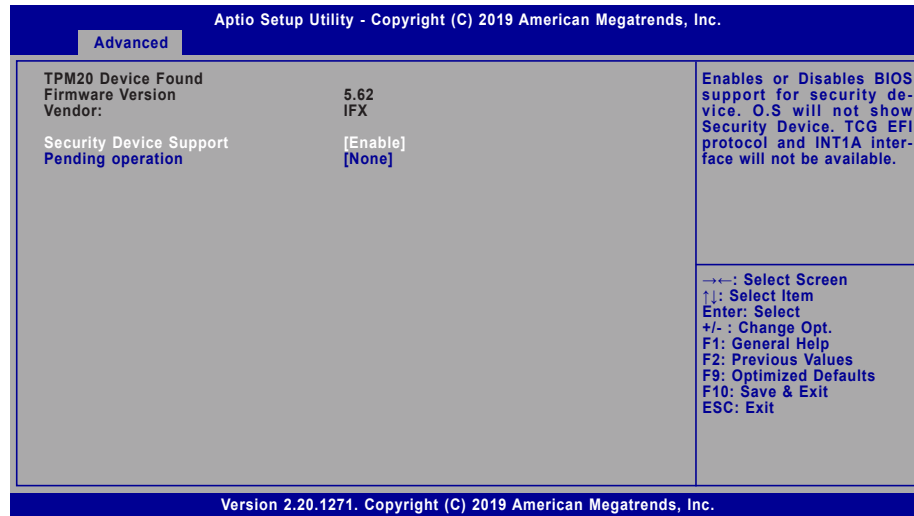

**Security Device Support**

This field is used to enable or disable BIOS support for the security device such as an TPM 2.0 to achieve hardware-level security via cryptographic keys.

**Pending operation**

To clear the existing TPM encryption, select "TPM Clear" and restart the system. This field is not available when "Security Device Support" is disabled.

▶ Advanced

NCT6116D Super IO Configuration

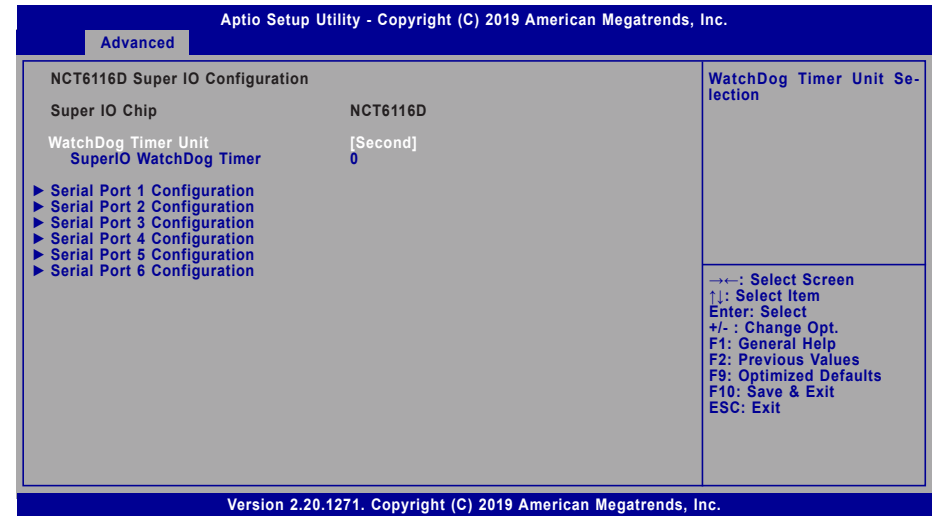

**WatchDog Timer Unit**

Select WatchDog Timer Unit — Second or Minute.

**SuperIO WatchDog Timer**

Set SuperIO WatchDog Timer Timeout value. The range is from 0 (disabled) to 255.



**Note:**  
The sub-menus are detailed in following sections.

▶ Serial Port 1/2/3/4/5/6 Configuration

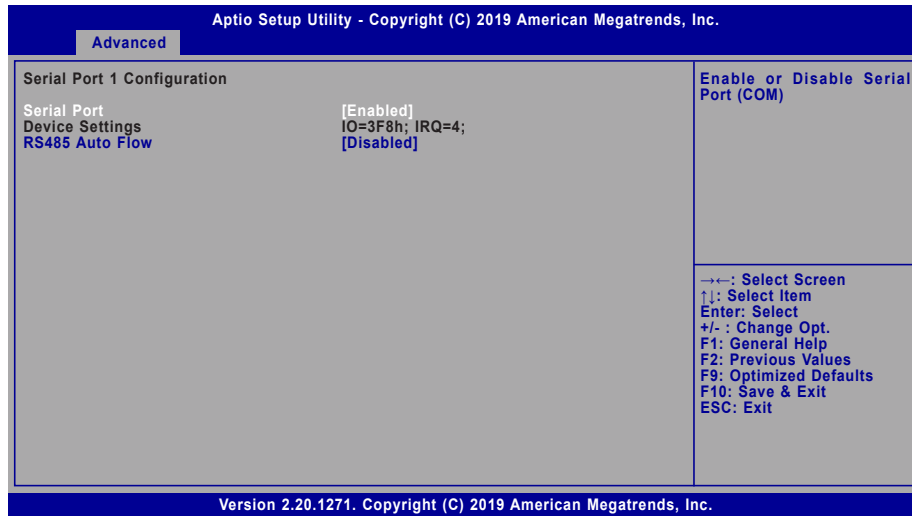

**Serial Port**

Enable or disable the current serial COM port.

**RS485 Auto Flow**

Enable or disable RS485 auto flow. This field is only available for COM ports that support RS485 mode.

NCT6116D HW Monitor

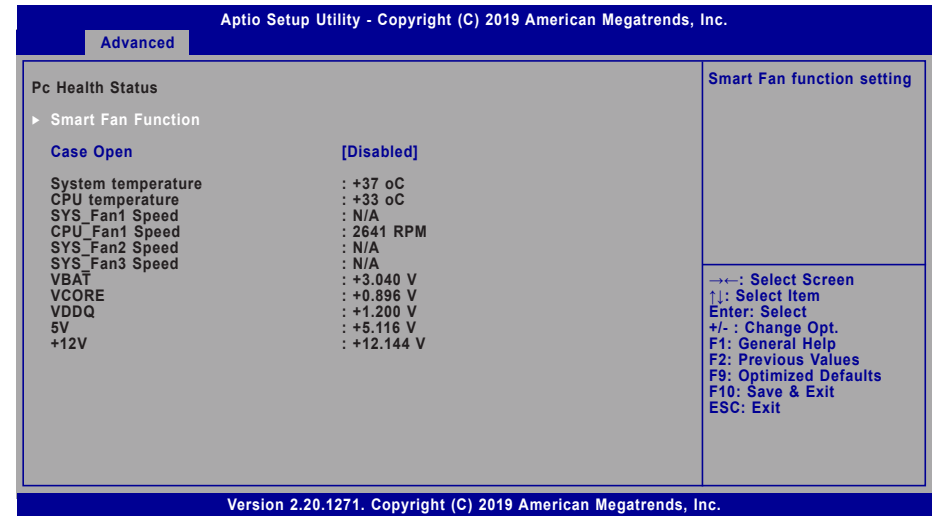

This section displays the system's health information, i.e. voltage readings, CPU and system temperatures, and fan speed readings.

**Case Open**

Enable or disable the case open detection function.

▶ Smart Fan Function

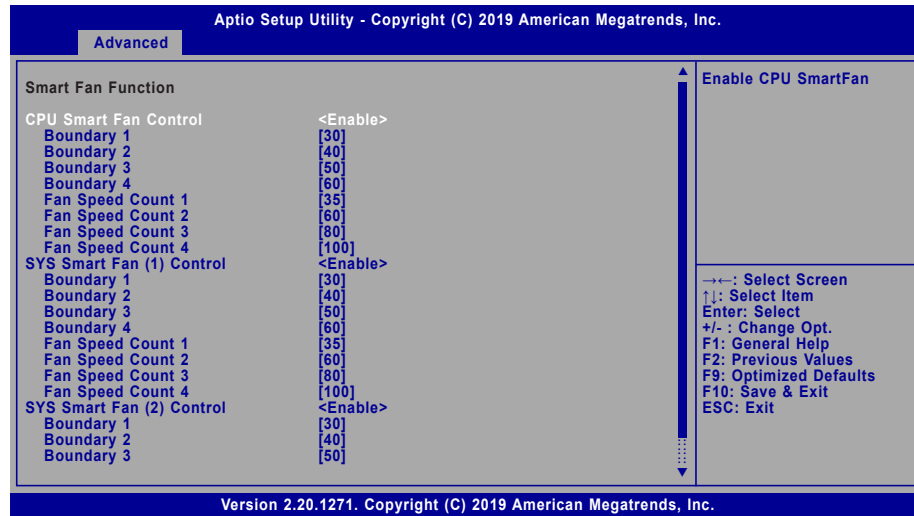

Smart Fan is a fan speed moderation strategy dependent on the current system temperature. When the system temperature goes higher than the Boundary setting, the fan speed will be turned up to the setting of the Fan Speed Count that bears the same index as the Boundary field.

▼ **SYS Smart Fan/CPU Smart Fan Control = [Enabled]**

**Boundary 1 to Boundary 4**

Set the boundary temperatures that determine the fan speeds accordingly, the value ranging from 0-127°C. For example, when the system temperature reaches Boundary 1 setting, the fan speed will be turned up to the designated speed of the Fan Speed Count 1 field.

**Fan Speed Count 1 to Fan Speed Count 4**

Set the fan speed, the value ranging from 1-100%, 100% being full speed. The fans will operate according to the specified boundary temperatures above-mentioned.

▼ **SYS Smart Fan/CPU Smart Fan Control = [Disabled]**

**Fix Fan Speed Count**

Set the fan speed, the value ranging from 1-100%, 100% being full speed. The fans will always operate at the specified speed regardless of gauged temperatures.

Serial Port Console Redirection

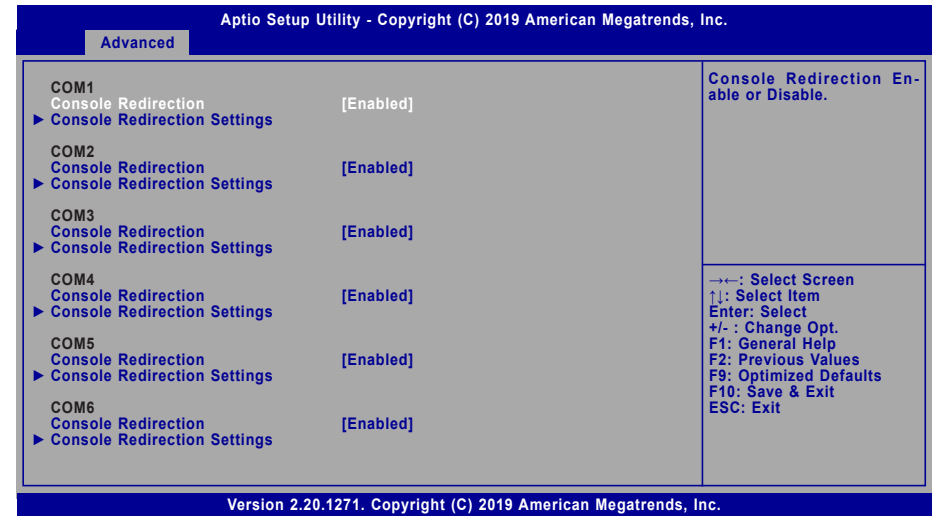

**Console Redirection**

By enabling Console Redirection of a COM port, the sub-menu of console redirection settings will become available for configuration as detailed in the following.

▶ Console Redirection Settings

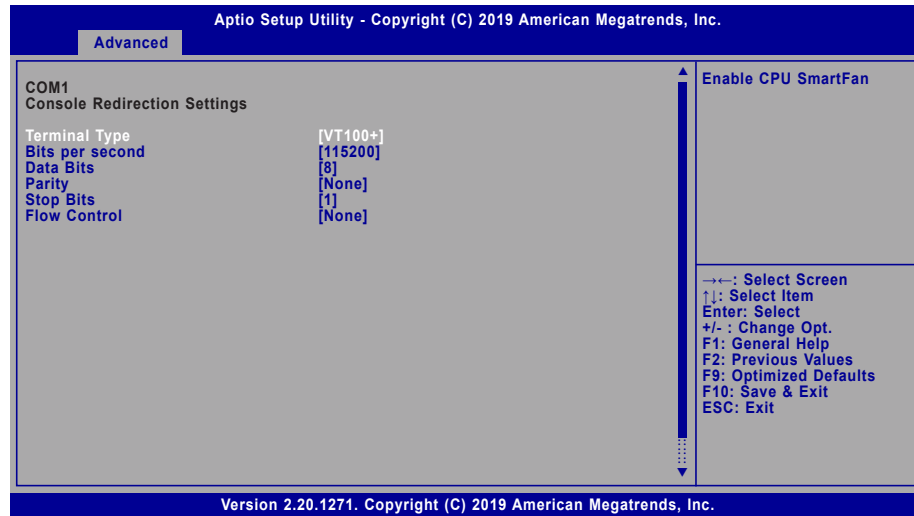

Configure the serial settings of the current COM port.

**Terminal Type**

Select terminal type: VT100, VT100+, VT-UTF8 or ANSI.

**Bits per second**

Select serial port transmission speed: 9600, 19200, 38400, 57600 or 115200.

**Data Bits**

Select data bits: 7 bits or 8 bits.

**Parity**

Select parity bits: None, Even, Odd, Mark or Space.

**Stop Bits**

Select stop bits: 1 bit or 2 bits.

**Flow Control**

Select flow control type: None or Hardware RTS/CTS. Flow Control is for RS485 mode and is only supported by Serial Port 1 (COM1).

USB Configuration

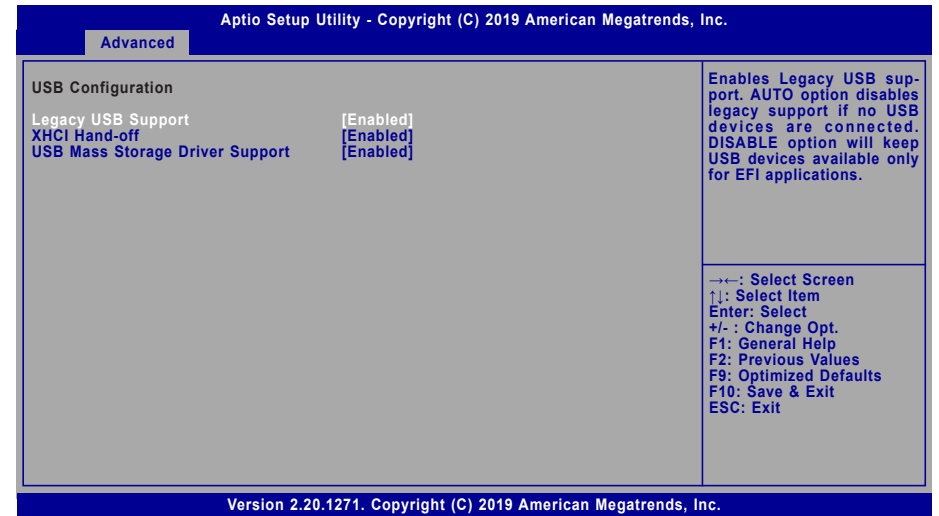

**Legacy USB Support**

- Enabled**      Enable Legacy USB support.
- Disabled**    Keep USB devices available only for EFI applications.
- Auto**          Disable Legacy support if no USB devices are connected.

**XHCI Hand-off**

Enable or disable XHCI Hand-off.

**USB Mass Storage Driver Support**

Enable or disable USB Mass Storage Driver Support.

▶ Advanced

### CSM Configuration

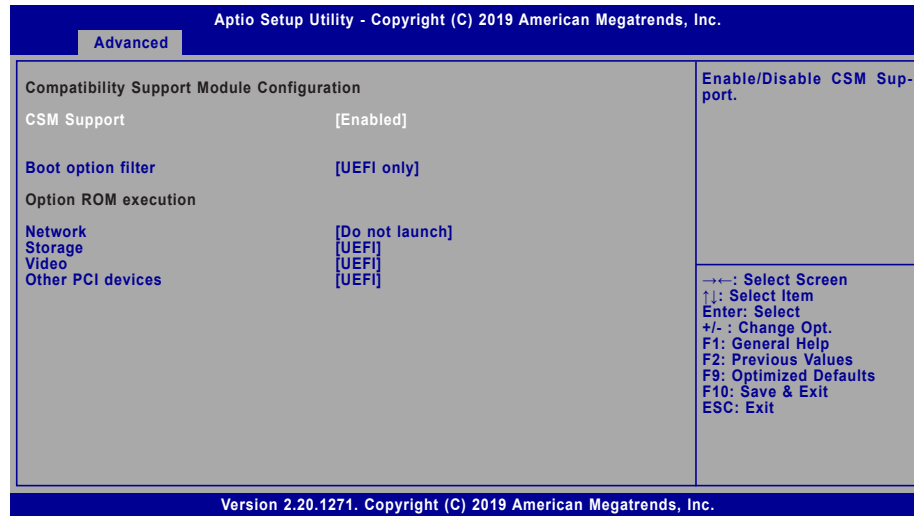

#### CSM Support

This section is used to enable or disable CSM Support. The following fields are only available when "CSM Support" is enabled.

#### Boot option filter

This field controls Legacy/UEFI ROMs priority. Select among UEFI and Legacy, Legacy only or UEFI only.

#### Network

This field controls the execution of UEFI and Legacy Network OpROM.

#### Storage

This field controls the execution of UEFI and Legacy Storage OpROM.

#### Video

This field controls the execution of UEFI and Legacy Video OpROM.

#### Other PCI devices

This field determines OpROM execution policy for devices other than Network, Storage or Video.

▶ Advanced

### USB Power Control

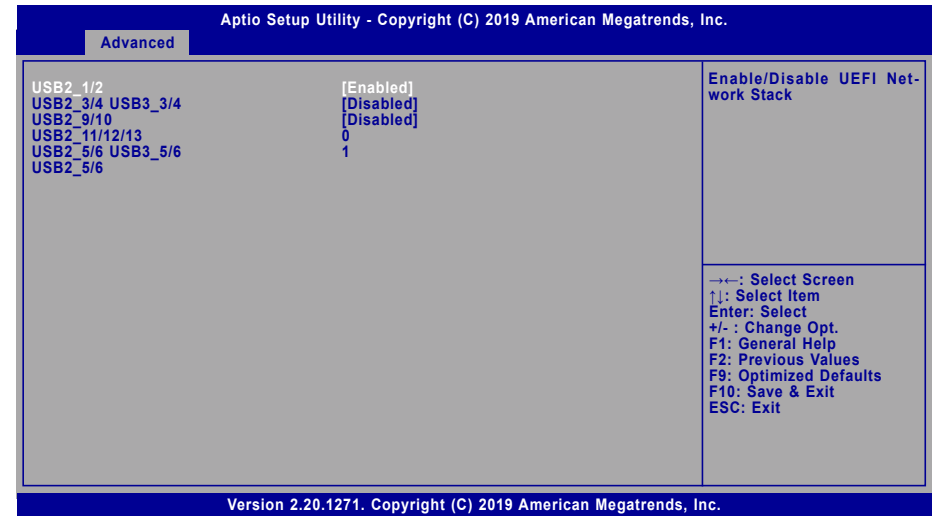

Select between 5V\_Dual (5VDU) and 5V for the USB power channel of each USB connector. To support Wake-on-USB, please select 5V\_Dual.



**Note:**

Please refer to chapter 2 for the locations of the USB ports.

► **Advanced**

**Network Stack Configuration**

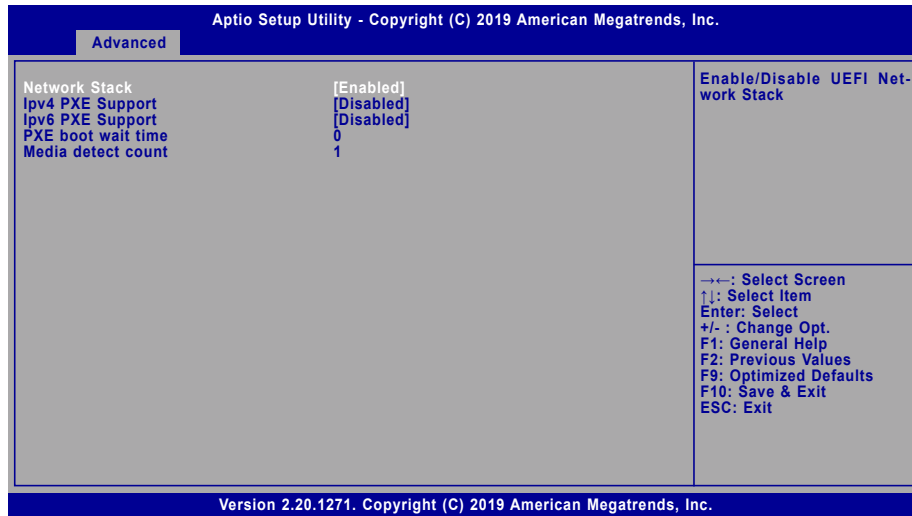

**Network Stack**

Enable or disable UEFI network stack. The following fields will appear when this field is enabled.

**Ipv4 PXE Support**

Enable or disable IPv4 PXE boot support. If disabled, IPv4 PXE boot support will not be available.

**Ipv6 PXE Support**

Enable or disable IPv6 PXE boot support. If disabled, IPv6 PXE boot support will not be available.

**PXE boot wait time**

Set the wait time in seconds to press ESC key to abort the PXE boot. Use either +/- or numeric keys to set the value.

**Media detect count**

Set the number of times the presence of media will be checked. Use either +/- or numeric keys to set the value.

► **Chipset**

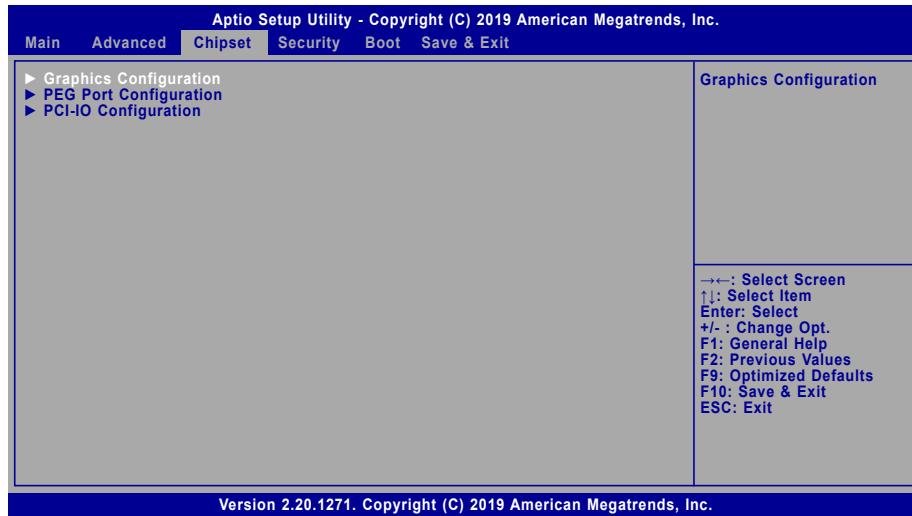

Please select a submenu and press Enter. The submenus are detailed in the following pages.

► **Chipset**

**Graphics Configuration**

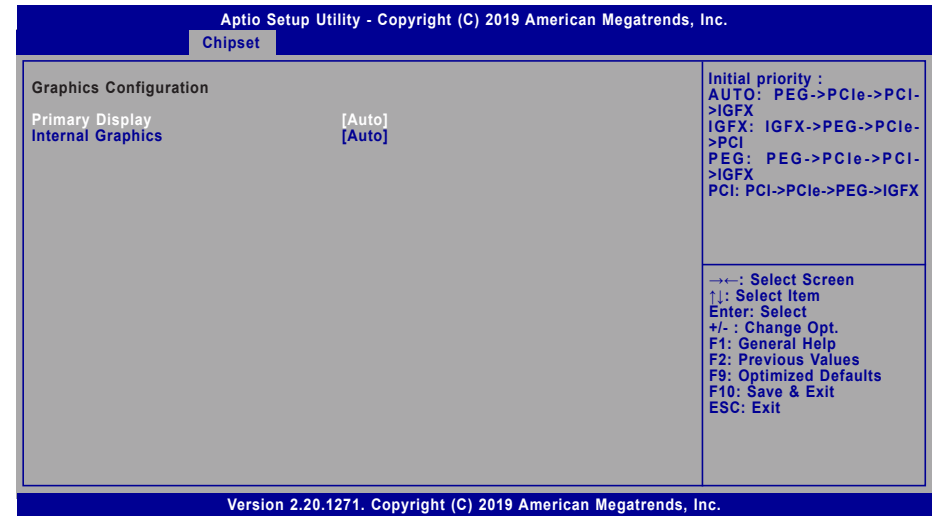

**Primary Display**

Select which of IGFX/PEG/PCI Graphics device to be the primary display.

**Internal Graphics**

Keep IGFX "Enabled" or "Disabled" based on the setup options, or select "Auto" for auto-detection.

► Chipset

PEG Port Configuration

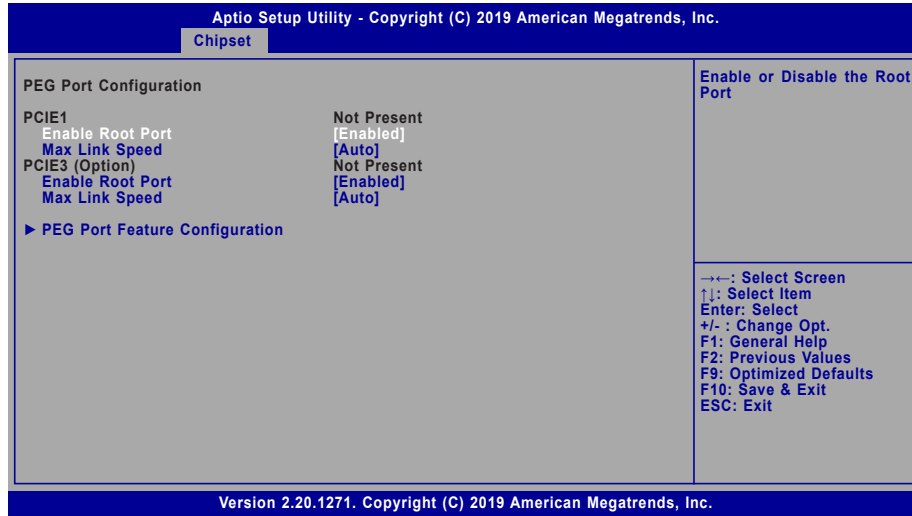

**Enable Root Port**

Enable or disable the root port, or select "Auto" for auto-detection.

**Max Link Speed**

Configure PCIE1/PCIE3 port's Max Speed: Auto, Gen1, Gen2 or Gen3.

► PEG Port Feature Configuration

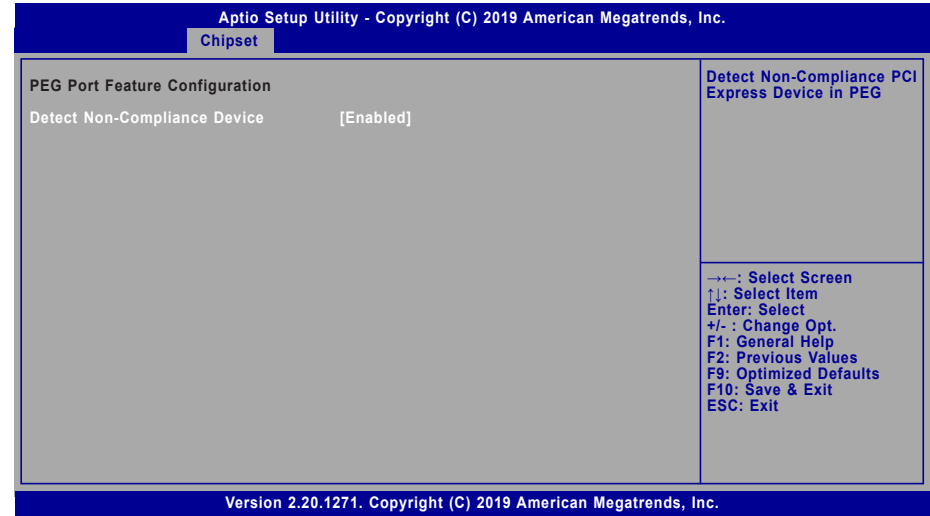

**Detect Non-Compliance Device**

Enable or disable this field to detect non-compliance PCIe devices in the PEG.



▶ Chipset

PCH-IO Configuration

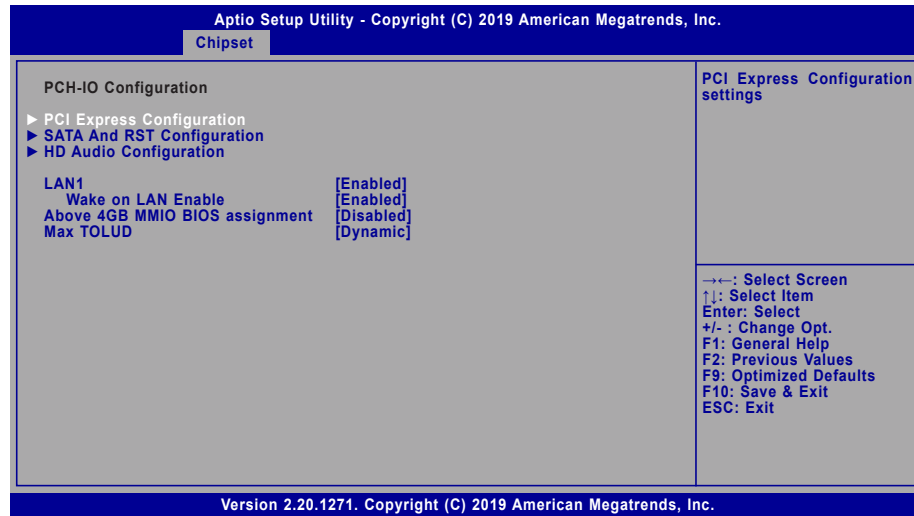

**LAN1(I219)**

Enable or disable onboard NIC.

**Wake on LAN Enable**

Enable or disable integrated LAN to wake the system.

**Above 4GB MMIO BIOS assignment**

Enable/Disable above 4GB MemoryMappedIO BIOS assignment. This is enabled automatically when Aperture Size is set to 2048MB.

**Max TOLUD**

Assign the maximum value of Top Of Lower Usable DRAM (TOLUD). Select to specify a fixed value, or select "Dynamic" so that the assignment would adjust TOLUD automatically based on largest MMIO length of installed graphic controller.



**Note:**

The sub-menus are detailed in following sections.

▶ Chipset ▶ PCH-IO Configuration

PCI Express Configuration

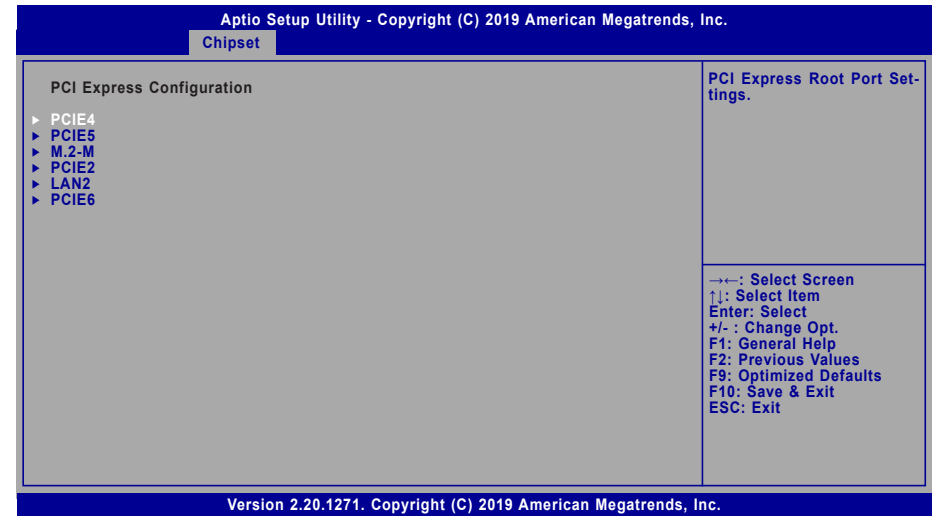

Select one of the PCI Express channels and press enter to configure the following settings.

**PCIE4/PCIE5/M.2-M/PCIE2/LAN2/PCIE6**

Enable or disable the PCI Express Root Port. The following fields are only available when the PCIe root port is enabled.

**PCIe Speed**

Select PCIe Speed of the current port — AUTO, Gen1, Gen 2, or Gen3. This field may not appear when the speed of the port is not configurable.

**Hot Plug**

Enable or disable hot plug function of the port. This field may not appear when the port does not support hot plug.

**Detect Non-Compliance Device**

Enable or disable this field to detect non-compliance PCIe devices in the PEG. This field may not appear when the port does not support Non-compliant device detection.

### SATA And RST Configuration

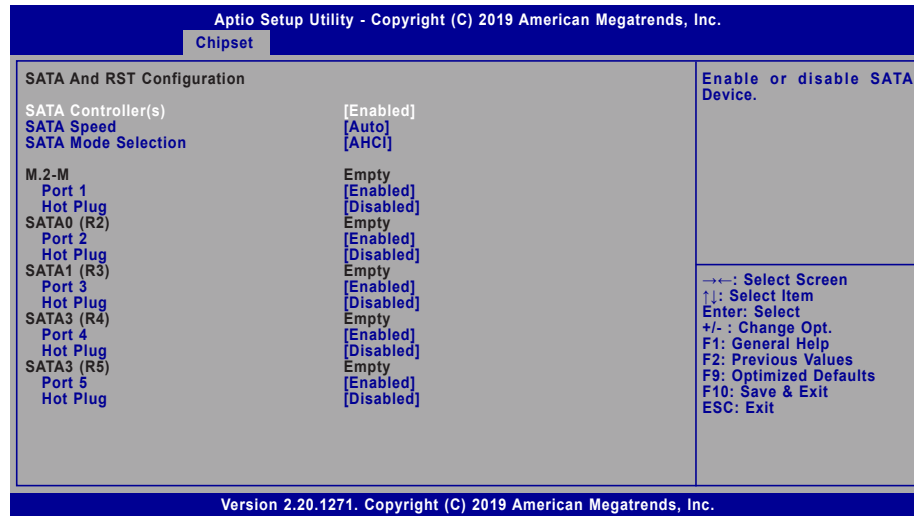

#### SATA Controller(s)

This field is used to enable or disable the Serial ATA controller.

#### SATA Speed

This field is used to select SATA speed generation limit: Auto, Gen1, Gen2 or Gen3.

#### SATA Mode Selection

The mode selection determines how the SATA controller(s) operates.

**AHCI** This option allows the Serial ATA controller(s) to use AHCI (Advanced Host Controller Interface).

**Intel RST Premium With Intel Optane System Acceleration** This option allows you to create RAID or Intel Rapid Storage configuration along with Intel® Optane™ system acceleration on Serial ATA devices.

#### Use RST Legacy OROM

This field shows up when SATA Mode Selection is set to Intel RST Premium With Intel Optane System Acceleration. Enable or disable to use RST Legacy OROM when CSM is enabled.

#### Port 1/2/3/4/5 and Hot Plug

Enable or disable the Serial ATA port and its hot plug function.

### HD Audio Configuration

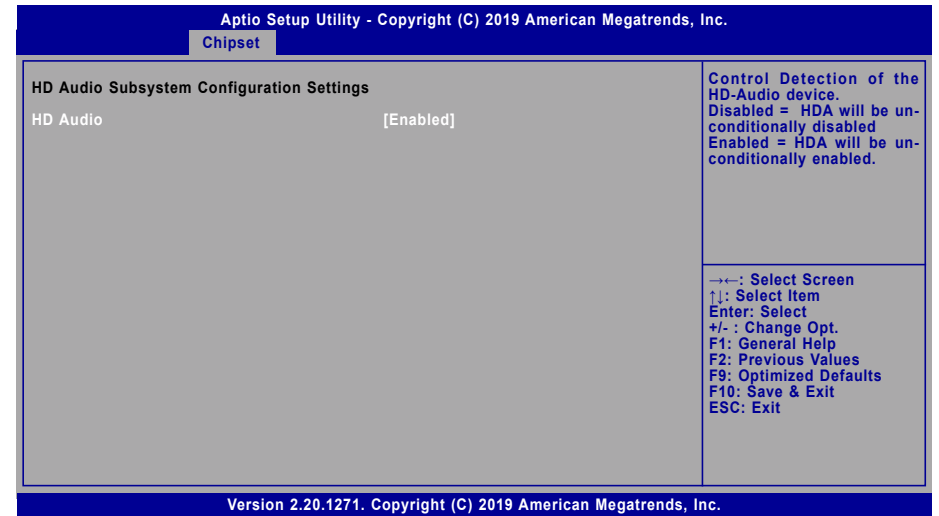

#### HD Audio

Control the detection of the HD Audio device.

**Disabled** HDA will be unconditionally disabled.

**Enabled** HDA will be unconditionally enabled.

► Security

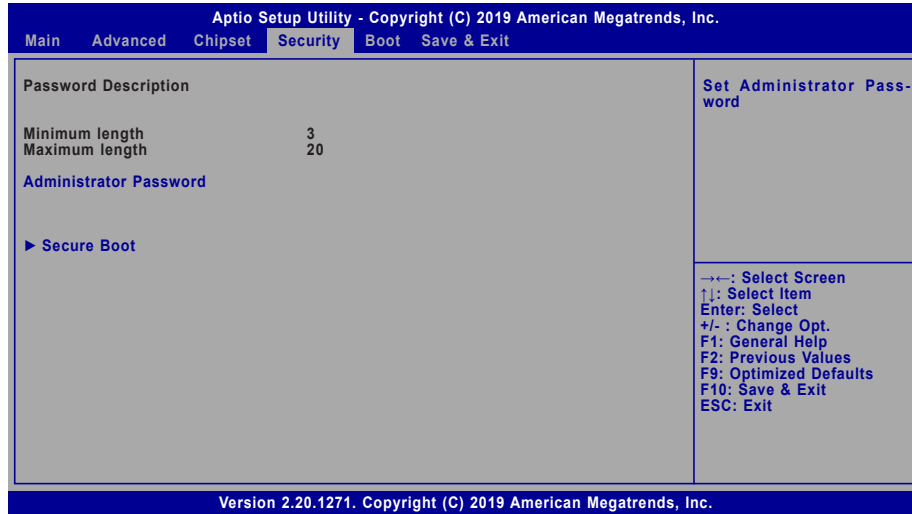

**Administrator Password**

Set the administrator password. To clear the password, input nothing and press enter when a new password is asked. Administrator Password will be required when entering the BIOS.

**User Password**

Set the user password. To clear the password, input nothing and press enter when a new password is asked. User Password will be required when powering up the system.

► Security

Secure Boot

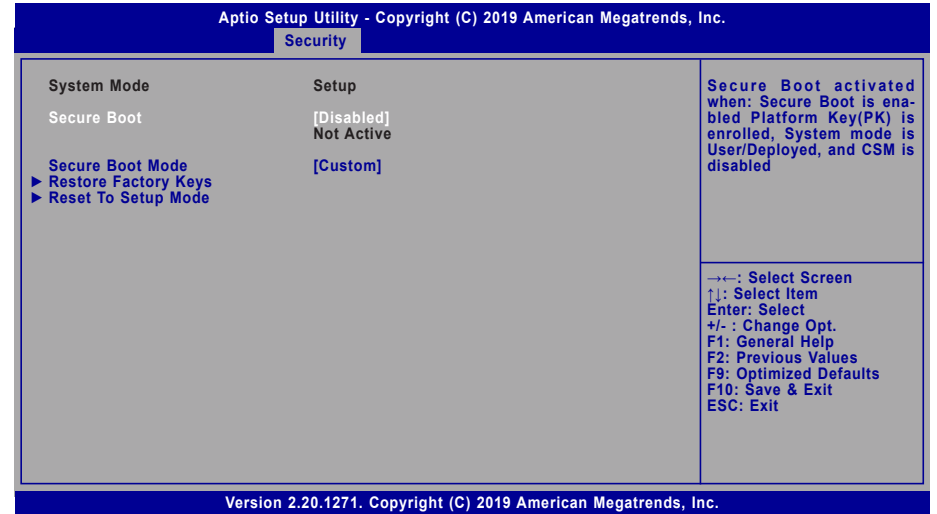

**Secure Boot**

The Secure Boot store a database of certificates in the firmware and only allows the OSeS with authorized signatures to boot on the system. To activate Secure Boot, please make sure that "Secure Boot" is "[Enabled]", Platform Key (PK) is enrolled, "System Mode" is "User", and CSM is disabled. After enabling/disabling Secure Boot, please save the configuration and restart the system. When configured and activated correctly, the Secure Boot status will be "Active".

**Secure Boot Customization**

Select the secure boot mode – Standard or Custom. When set to Custom, the following fields will be configurable for the user to manually modify the key database.

**Restore Factory Keys**

Force system to User Mode. Load OEM-defined factory defaults of keys and databases onto the Secure Boot. Press Enter and a prompt will show up for you to confirm.

**Reset To Setup Mode**

Clear the database from the NVRAM, including all the keys and signatures installed in the Key Management menu. Press Enter and a prompt will show up for you to confirm.

► **Boot**

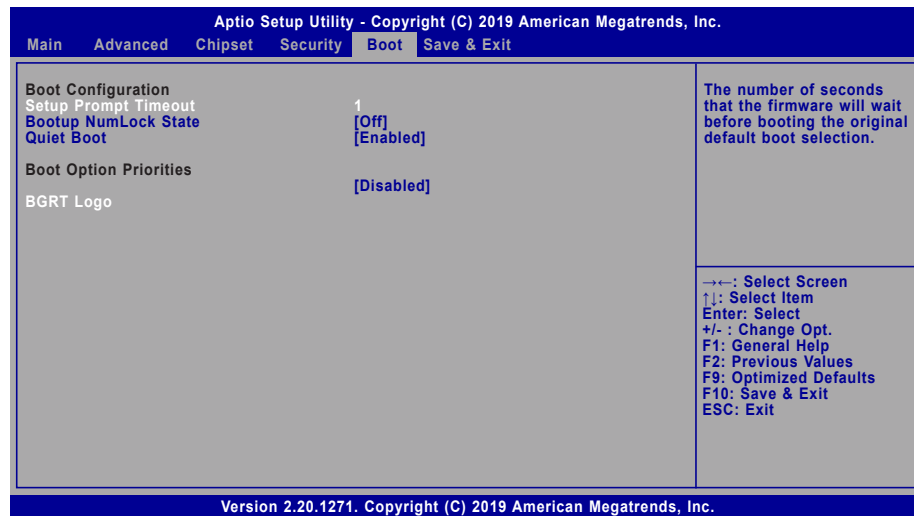

**Setup Prompt Timeout**

Set the number of seconds to wait for the setup activation key. 65535 (0xFFFF) denotes indefinite waiting.

**Bootup NumLock State**

Select the keyboard NumLock state: On or Off.

**Quiet Boot**

This section is used to enable or disable quiet boot option.

**Boot Option Priorities**

Rearrange the system boot order of available boot devices.

**BGRT Logo**

It is used to enable or disable to support display logo with ACPI BGRT table.



**Note:**

If "Boot option filter" of "CSM Configuration" is set to "UEFI and Legacy" or "UEFI only", and "Quiet Boot" is set to enabled, "BGRT Logo" will show up for configuration. Refer to the Advanced > CSM Configuration submenu for more information.

► **Save & Exit**

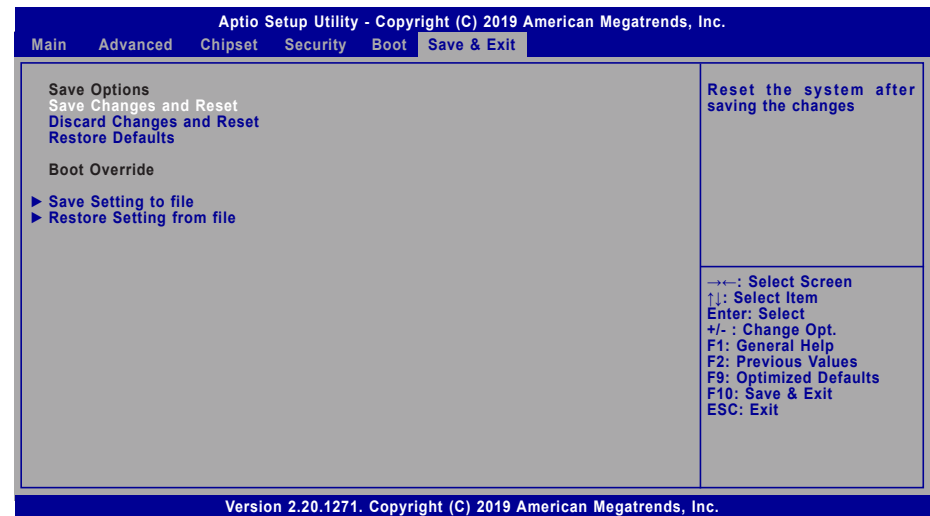

**Save Changes and Reset**

To save the changes, select this field and then press <Enter>. A dialog box will appear. Select Yes to reset the system after saving all changes made.

**Discard Changes and Reset**

To discard the changes, select this field and then press <Enter>. A dialog box will appear. Select Yes to reset the system setup without saving any changes.

**Restore Defaults**

To restore and load the optimized default values, select this field and then press <Enter>. A dialog box will appear. Select Yes to restore the default values of all the setup options.

**Boot Override**

Move the cursor to an available boot device and press Enter, and then the system will immediately boot from the selected boot device. The Boot Override function will only be effective for the current boot. The "Boot Option Priorities" configured in the Boot menu will not be changed.

► **Save Setting to file**

Select this option to save BIOS configuration settings to a USB flash device.

► **Restore Setting from file**

This field will appear only when a USB flash device is detected. Select this field to restore setting from the USB flash device.

## ► Updating the BIOS

To update the BIOS, you will need the new BIOS file and a flash utility. Please contact technical support or your sales representative for the files and specific instructions about how to update BIOS with the flash utility. For updating AMI BIOS in UEFI mode, you may refer to the how-to video at <https://www.dfi.com/Knowledge/Video/5>.

## ► Notice: BIOS SPI ROM

1. The Intel® Management Engine has already been integrated into this system board. Due to the safety concerns, the BIOS (SPI ROM) chip cannot be removed from this system board and used on another system board of the same model.
2. The BIOS (SPI ROM) on this system board must be the original equipment from the factory and cannot be used to replace one which has been utilized on other system boards.
3. If you do not follow the methods above, the Intel® Management Engine will not be updated and will cease to be effective.



**Note:**

- a. You can take advantage of flash tools to update the default configuration of the BIOS (SPI ROM) to the latest version anytime.
- b. When the BIOS IC needs to be replaced, you have to populate it properly onto the system board after the EEPROM programmer has been burned and follow the technical person's instructions to confirm that the MAC address should be burned or not.

## Chapter 4 - Intel AMT Settings

### ► Overview

Intel Active Management Technology (Intel® AMT) combines hardware and software solution to provide maximum system defense and protection to networked systems. The hardware and software information are stored in non-volatile memory. With its built-in manageability and latest security applications, Intel® AMT provides the following functions.

#### Discover

Allows remote access and management of networked systems even while PCs are powered off; significantly reducing desk-side visits.

#### Repair

Remotely repair systems after OS failures. Alerting and event logging help detect problems quickly to reduce downtime.

#### Protect

Intel AMT's System Defense capability remotely updates all systems with the latest security software. It protects the network from threats at the source by proactively blocking incoming threats, reactively containing infected clients before they impact the network, and proactively alerting when critical software agents are removed.

### ► Enable Intel® AMT in the AMI BIOS

1. Power-on the system then press <Del> to enter the main menu of the AMI BIOS.
2. In the **Advanced** menu, select **PCH-FW Configuration**.

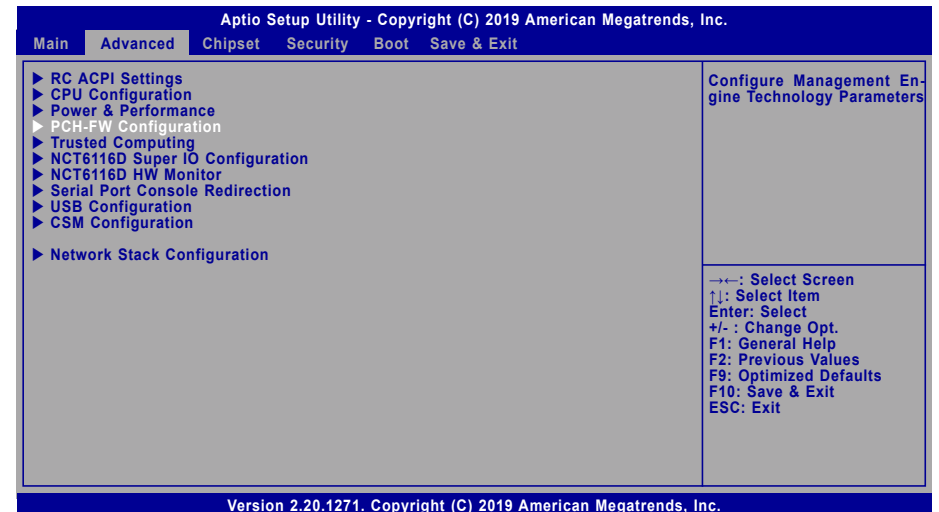

3. Set the **AMT BIOS Features** field to **Enabled**.

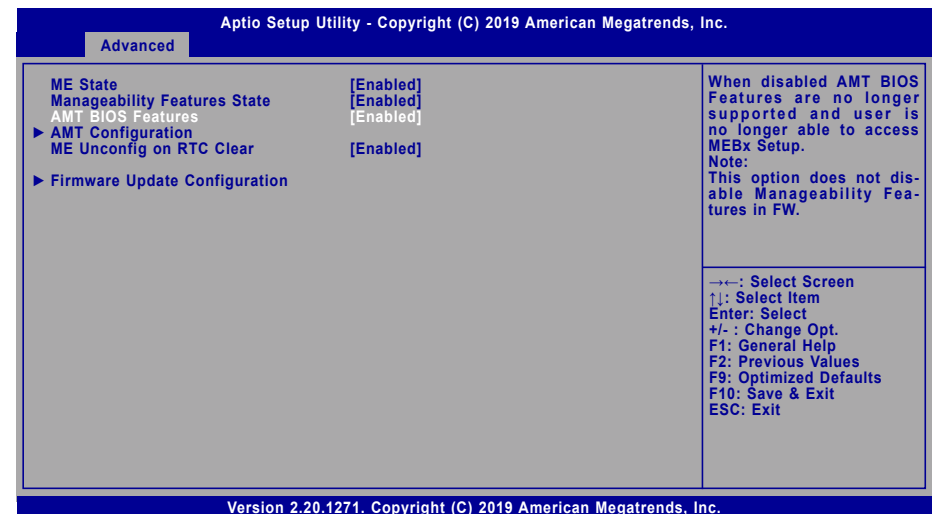

► **Enable Intel® AMT in the AMI BIOS**

4. Press F4, or go to the **Save & Exit** menu, select **Save Changes and Reset** and then press <Enter>. A dialog box will appear. Select **Yes** and press Enter to reset the system after saving all changes made.

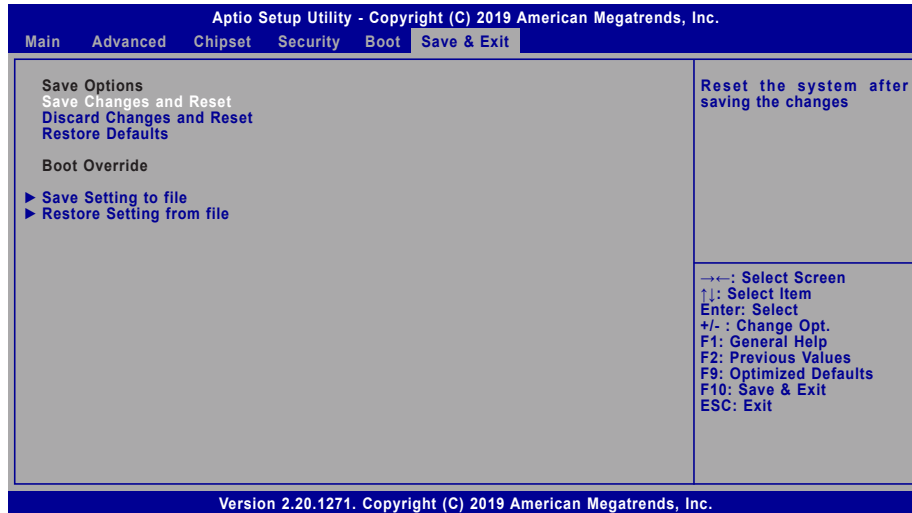

► **Entering Management Engine BIOS Extension (MEBX)**

When the system reboots, the following message will be displayed. Press **<Ctrl + P>** as soon as the message is displayed. This message will only be displayed very briefly.



► **MEBX**

Main Menu

Select **MEBx Login** under Main Menu and press Enter. A prompt that requires password input will show up.

1. Enter the default password "**admin**".

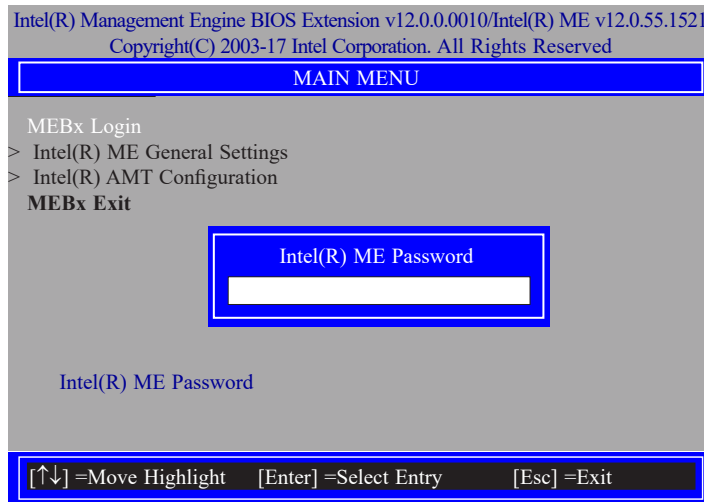

2. Enter a new password and then press Enter. The password must include
  - 8-32 characters;
  - Strong 7-bit ASCII characters excluding : , and " characters;
  - At least one digit character (0, 1, ...9);
  - At least one 7-bit ASCII non alpha-numeric character, above 0x20, (e.g. !, \$, );
  - At least one lower case and one upper case characters.
3. Enter the new password again to verify the new password.

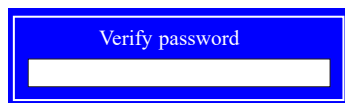

Intel(R) ME General Settings

Select **Intel(R) ME General Settings** under Main Menu and then press Enter.

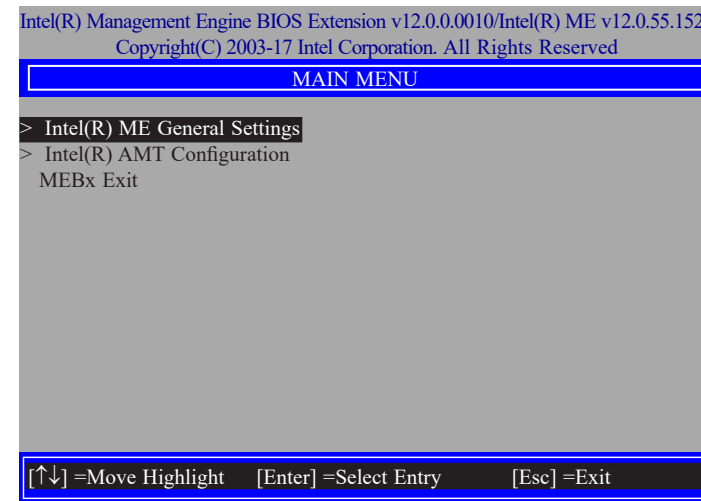



**Change ME Password**

If you want to change ME password, select **Change ME Password** and then press Enter. A prompt that requires password input will show up.

1. Enter the current password and then press Enter.

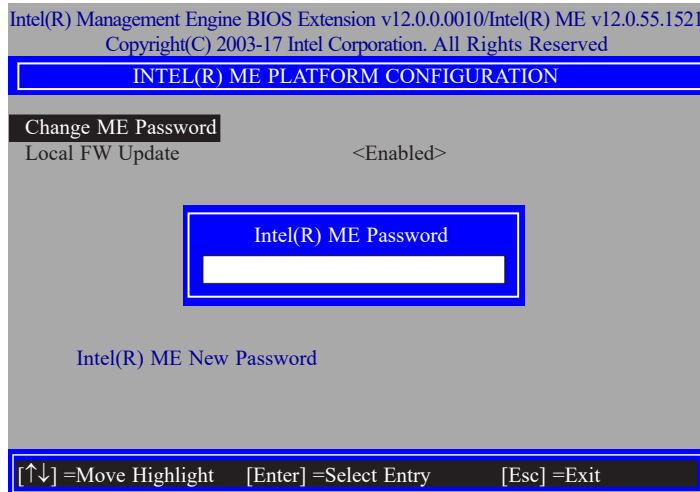

2. Enter a new password and then press Enter. The password must include
  - 8-32 characters;
  - Strong 7-bit ASCII characters excluding : , and " characters;
  - At least one digit character (0, 1, ...9);
  - At least one 7-bit ASCII non alpha-numeric character, above 0x20, (e.g. !, \$, ,);
  - At least one lower case and one upper case characters.
3. Enter the new password again to verify the new password.

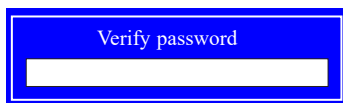

**Local FW Update**

Select **Local FW Update** then press Enter. Select **Enabled** or **Disabled** or **Password Protected** then press Enter.

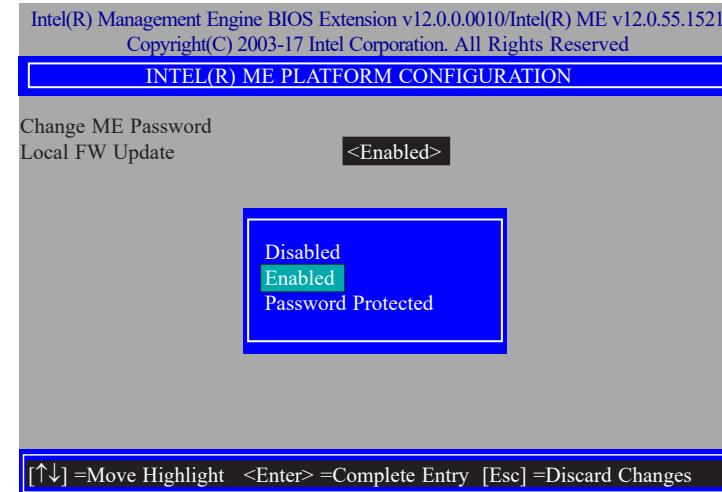

► MEBX

Intel(R) AMT Configuration

Select Intel(R) AMT Configuration under Main Menu and then press Enter.

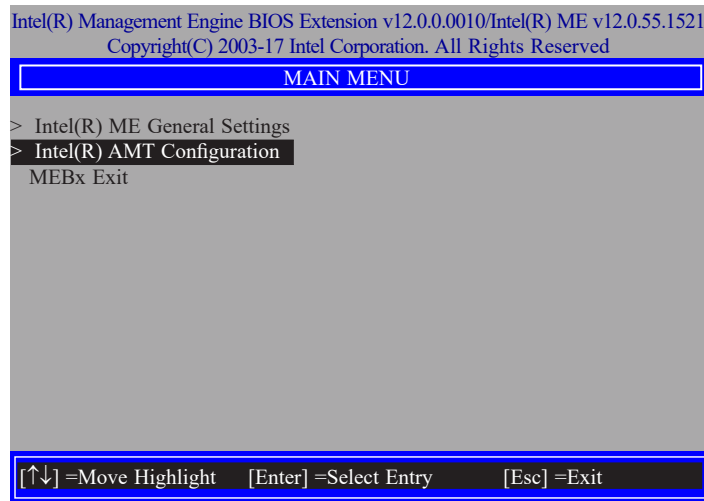

Manageability Feature Selection

Select **Enabled** or **Disabled** then press Enter. When disabled, all the following fields will be hidden. After disabling the field, system restart is required.

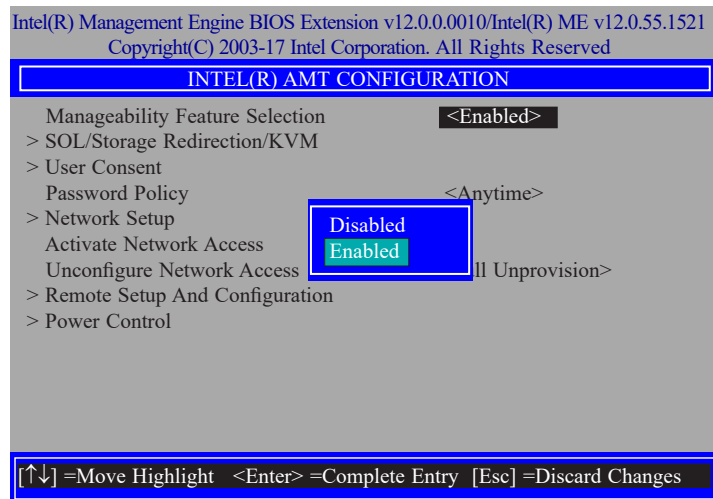

> SOL/Storage Redirection/KVM

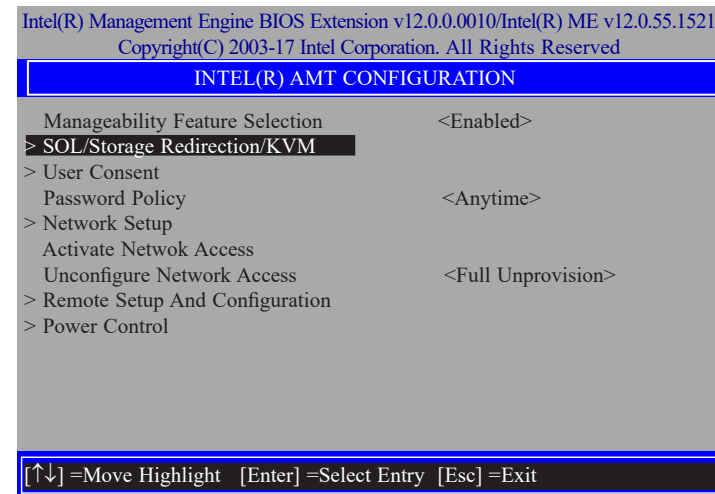

Press Enter to enter the submenu.

> **SOL/Storage Redirection/KVM**

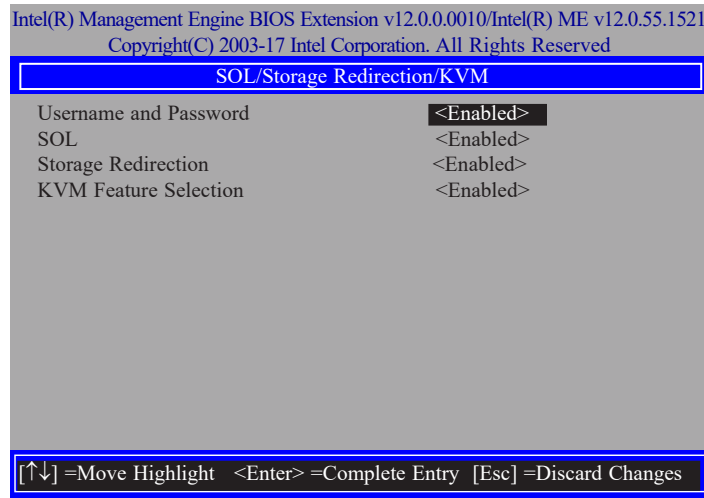

Move the cursor to select a field and press Enter to display options.

**Username and Password**

Select Enabled or Disabled then press Enter.

**SOL**

Select Enabled or Disabled then press Enter.

**Storage Redirection**

Select Enabled or Disabled then press Enter.

**KVM Feature Selection**

Select Enabled or Disabled then press Enter.



> **User Consent**

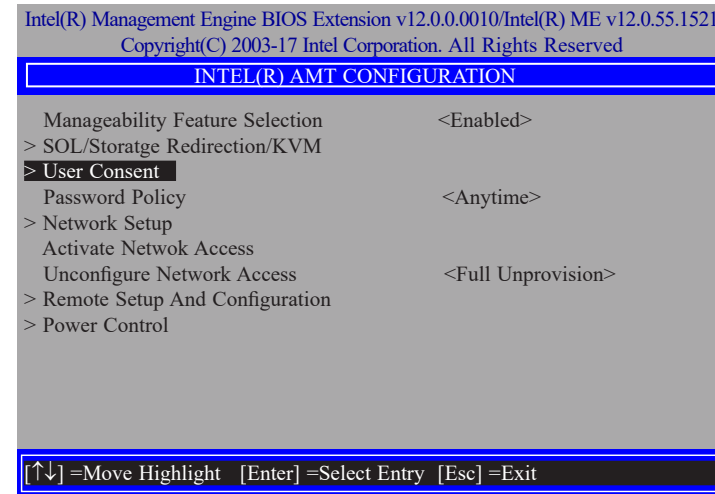

Press Enter to enter the submenu.

> User Consent

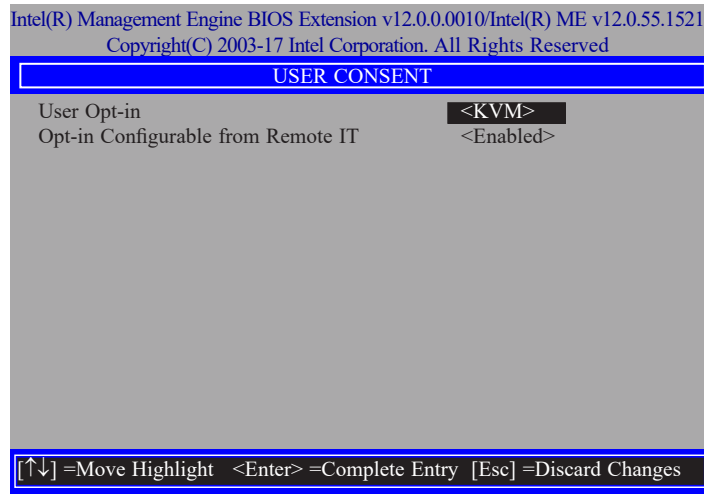

Move the cursor to select a field and press Enter to display options.

**User Opt-in**

Select **NONE** or **KVM** or **ALL** then press Enter.



**Opt-in Configurable from Remote IT**

Select **Enabled** or **Disabled** then press Enter.



Password Policy

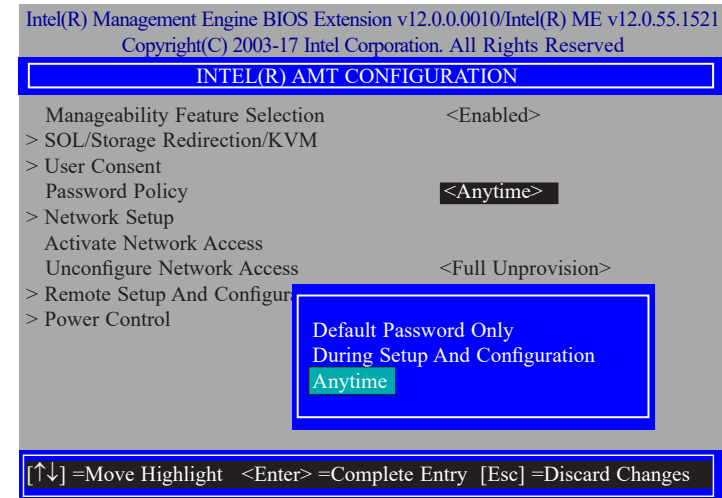

Under the **Intel(R) AMT Configuration** menu, select **Password Policy** then press Enter. You may choose to use a password only during setup and configuration or to use a password anytime the system is being accessed.

> **Network Setup**

Under the **Intel(R) AMT Configuration** menu, select **Network Setup** and then press Enter.

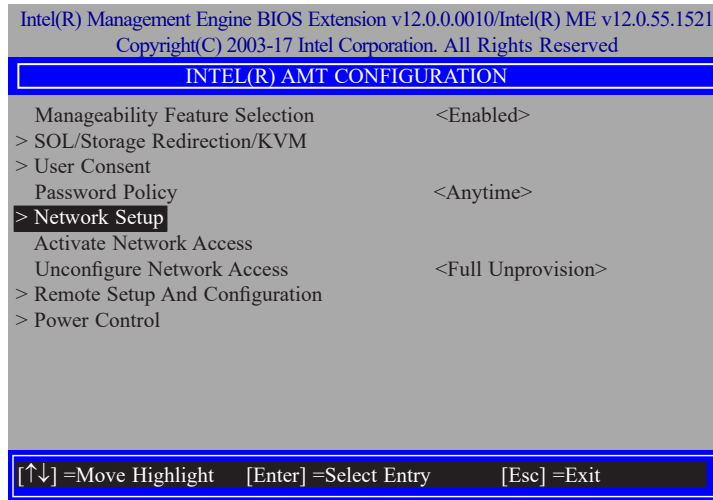

> **Intel(R) ME Network Name Settings**

Under the **Intel(R) ME Network Setup** menu, select **Intel(R) ME Network Name Settings** and then press Enter.

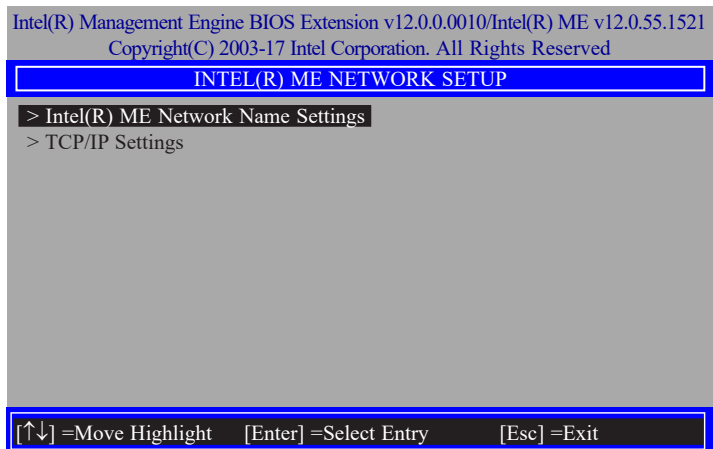

Move the cursor to select a field and press Enter to display options.

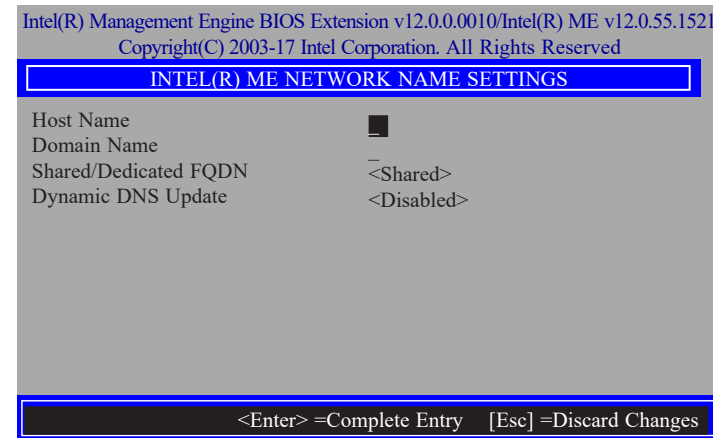

**Host Name**

Enter the computer's host name and then press Enter.



**Domain Name**

Enter the computer's domain name and then press Enter.



**Shared/Dedicated FQDN**

Select **Shared** or **Dedicated** and then press Enter.



### Dynamic DNS Update

Select Enabled or Disabled then press Enter. When Dynamic DNS Update is Enabled, the following fields will show up.



### Periodic Update Interval

Enter a value and then press Enter.

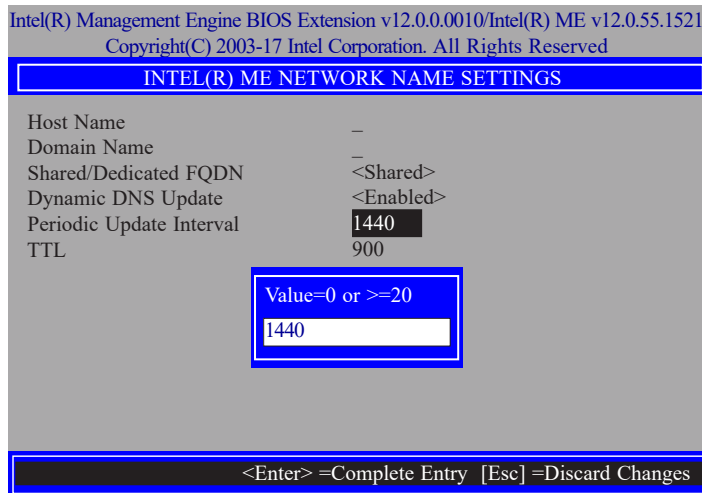

### TTL

Enter a value for the Time-to-live (TTL) field and then press Enter.

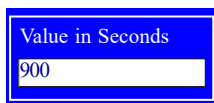

### > TCP/IP Settings

Under the Intel(R) ME Network Setup menu, select TCP/IP Settings and then press Enter.

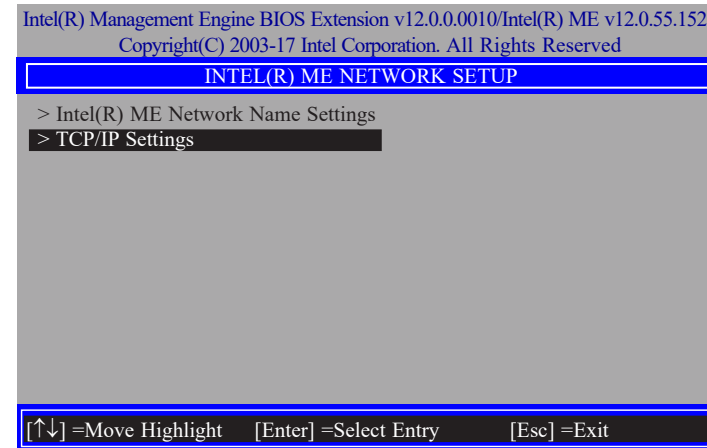

### > Wired LAN IPV4 Configuration

Under TCP/IP Settings, select Wired LAN IPV4 Configuration and then press Enter.

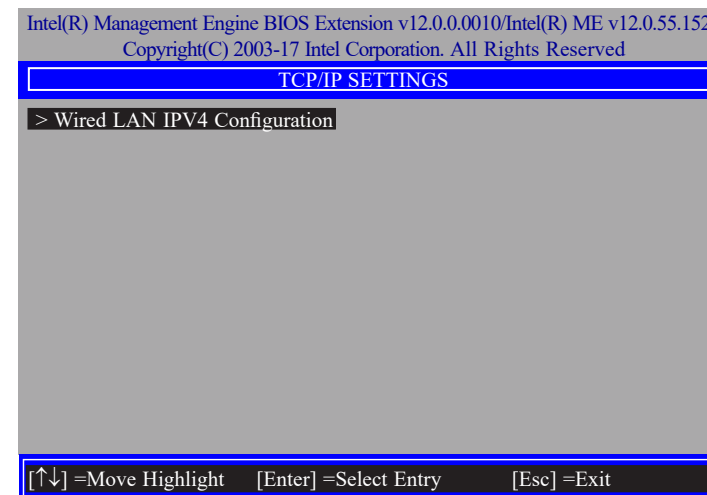

### DHCP Mode

Select **Enabled** or **Disabled** then press Enter. Please make sure there is a DHCP server in the network when this field is enabled.

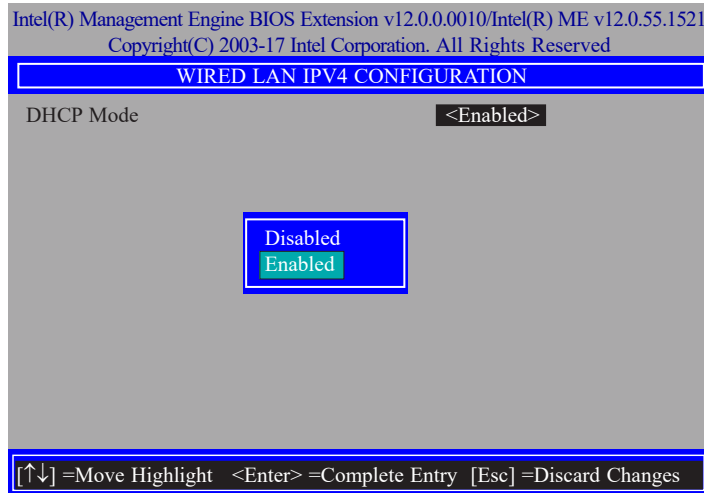

When DHCP is **Disabled**, please manually input a static route by configuring the fields as shown below.

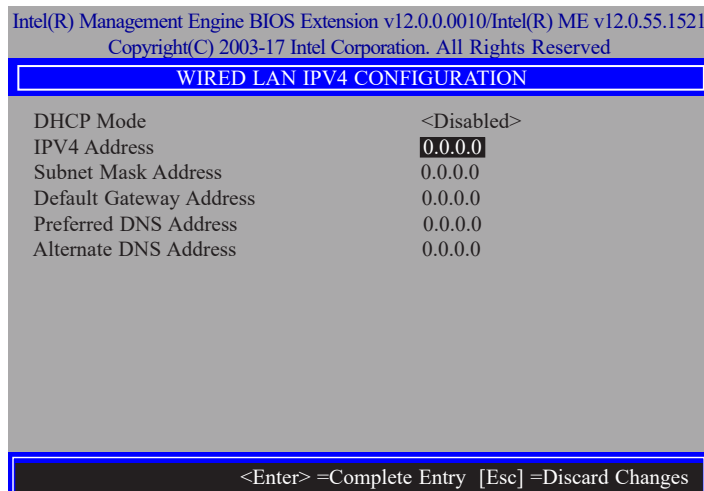

### IPv4 Address

Assign a valid and available IP address to the system. Insert a value from 0.0.0.0 to 255.255.255.255 in IPv4 format.

IP address (e.g. 123.123.123.100)

### Subnet Mask Address

Insert a value from 0.0.0.0 to 255.255.255.255 in IPv4 format.

Subnet mask (e.g. 255.255.255.0)

### Default Gateway Address

Insert a value from 0.0.0.0 to 255.255.255.255 in IPv4 format.

Default Gateway address

### Preferred DNS Address

Insert a value from 0.0.0.0 to 255.255.255.255 in IPv4 format.

Preferred DNS address

### Alternate DNS Address

Insert a value from 0.0.0.0 to 255.255.255.255 in IPv4 format.

Alternate DNS address

**Activate Network Access**

Under the **Intel(R) AMT Configuration** menu, select **Activate Network Access** and press Enter, and then press Y to activate the ME network connection with the settings configured previously, or press N to abort.

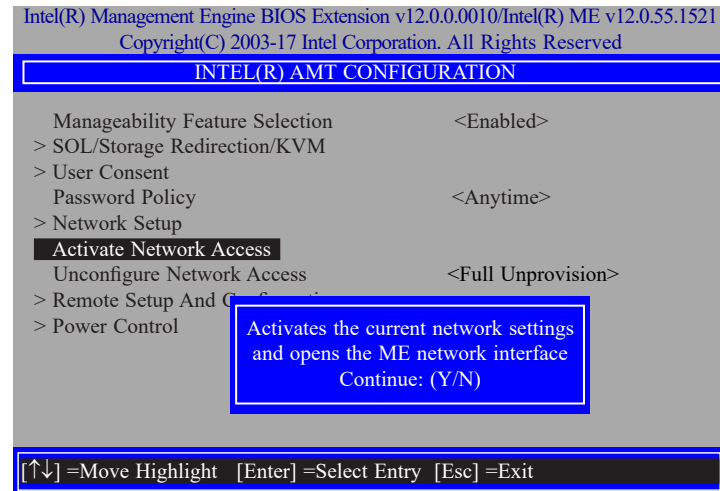

**Unconfigure Network Access**

Under the **Intel(R) AMT Configuration** menu, select **Unconfigure Network Access** and press Enter, and then press Enter to fully deactivate the ME network connection and reset configuration to factory default. Press Y to confirm or N to abort.

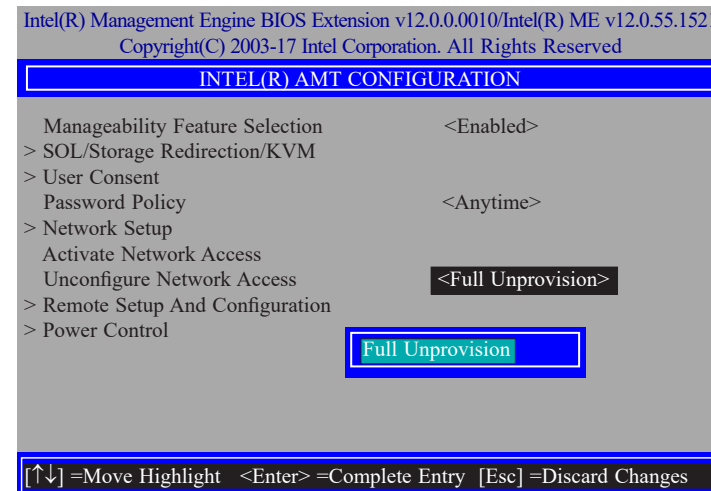



> Remote Setup And Configuration

Under the **Intel(R) AMT Configuration** menu, select **Remote Setup And Configuration** then press Enter.

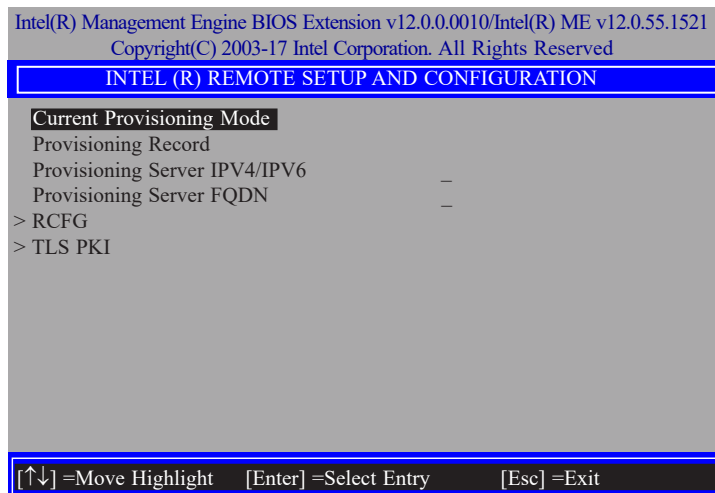
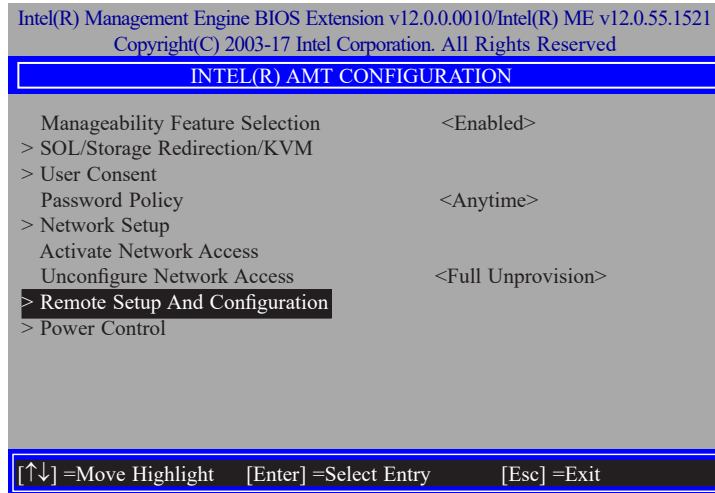

**Current Provisioning Mode**

The current mode – Public Key Infrastructure (PKI) – is displayed.



**Provisioning Record**

Press Enter to view the record.



**Provisioning Server IPV4/IPV6**

Enter the address of the server then press Enter, and then insert the TCP/UDP port number.

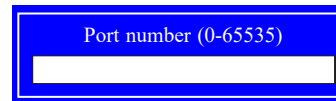
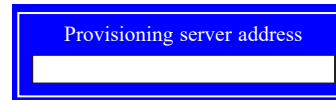

**Provisioning Server FQDN**

Enter the Fully Qualified Domain Name (FQDN) of the server and then press Enter.



> **RCFG**

Press Enter, select **Start Configuration**, and then press Enter to activate Remote Configuration (RCFG). Press Y to confirm or N to abort.

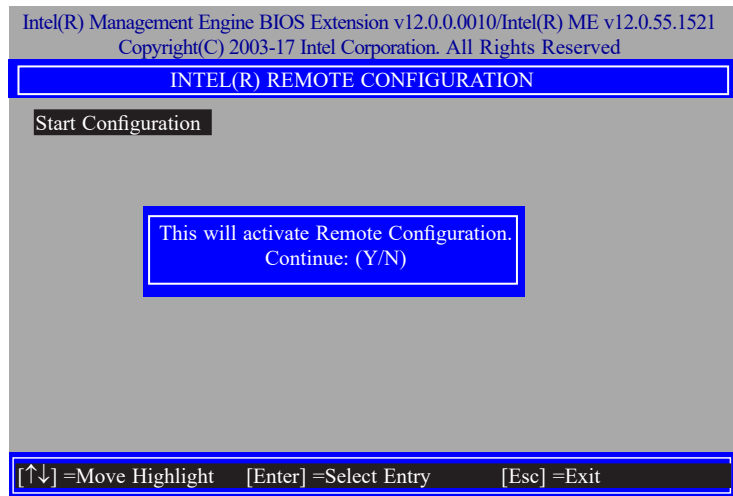

> **TLS PKI**

The system adopts PKI for encryption and authentication, and the TLS protocol for communication security to ensure remote configuration safety.

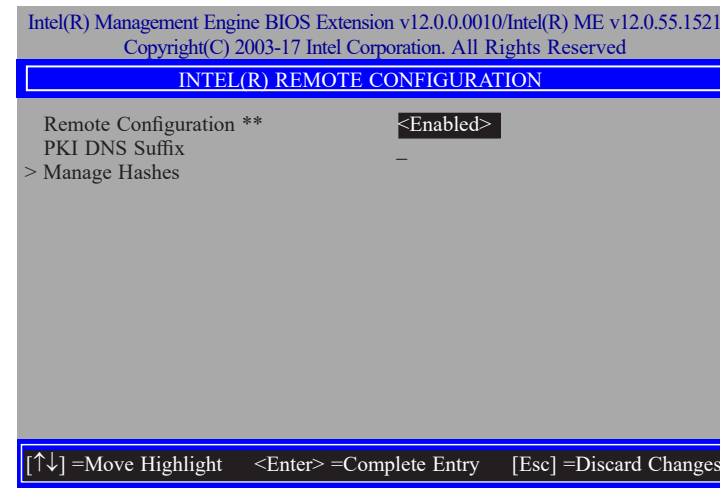

**Remote Configuration \*\***

Select **Enabled** or **Disabled** then press Enter.



**PKI DNS Suffix**

Specify the DNS Suffix of the PKI server, and then press Enter.



> Manage Hashes

Select a hash name and then press the following keys to execute a function.

- Insert – enter a custom hash certificate name,
- Delete – delete a hash
- Enter – view hash information
- + – activate or deactivate a hash
- Esc – exit

Intel(R) Management Engine BIOS Extension v12.0.0.0010/Intel(R) ME v12.0.55.1521  
Copyright(C) 2003-17 Intel Corporation. All Rights Reserved

**INTEL(R) REMOTE CONFIGURATION**

Hash Name	Active	Default	Algorithm
VeriSign Class 3	Active: [*]	Default: [*]	SHA256
VeriSign Class 3	Active: [*]	Default: [*]	SHA256
Go Daddy Class 2	Active: [*]	Default: [*]	SHA256
Comodo AAA CA	Active: [*]	Default: [*]	SHA256
Starfield Class 2	Active: [*]	Default: [*]	SHA256
VeriSign Class 3	Active: [*]	Default: [*]	SHA256
VeriSign Class 3	Active: [*]	Default: [*]	SHA256
VeriSign Class 3	Active: [*]	Default: [*]	SHA256
GTE CyberTrust G1	Active: [*]	Default: [*]	SHA256
Baltimore Cyber Tr	Active: [*]	Default: [*]	SHA256
Cyber Trust Global	Active: [*]	Default: [*]	SHA256
Verizon Global Ro	Active: [*]	Default: [*]	SHA256
Entrust. net CA (2	Active: [*]	Default: [*]	SHA256
Entrust Root CA	Active: [*]	Default: [*]	SHA256
VeriSign Universa	Active: [*]	Default: [*]	SHA256
Go Daddy Root CA	Active: [*]	Default: [*]	SHA256
Entrust Root CA -	Active: [*]	Default: [*]	SHA256
Startfield Root CA	Active: [*]	Default: [*]	SHA256

[Ins] =Add New Hash    [Delete] =Delete Hash    [+] =Activate Hash  
[↑↓] =Move Highlight    [Enter] =View Hash    [Esc] =Exit

> Power Control

Under the Intel(R) AMT Configuration menu, select Power Control then press Enter.

Intel(R) Management Engine BIOS Extension v12.0.0.0010/Intel(R) ME v12.0.55.1521  
Copyright(C) 2003-17 Intel Corporation. All Rights Reserved

**INTEL(R) AMT POWER CONTROL**

These configurations are effective only after AMT provisioning has started

Intel(R) AMT ON in Host Sleep States <Desktop: ON in S0, ME Wake in S3, S4-5>

Idle Timeout 65535

[↑↓] =Move Highlight    <Enter> =Complete Entry    [Esc] =Discard Changes

Intel(R) AMT ON in Host Sleep States

Select an option and then press Enter.

Desktop: ON in S0  
Desktop: ON in S0, ME Wake in S3, S4-5

Idle Timeout

Enter a timeout value and press Enter.

Timeout Value (1-65535)  
65535

► MEBX

**MEBx Exit**

Under the Main Menu, select MEBx Exit and then press Enter. Press Y to confirm or N to abort.

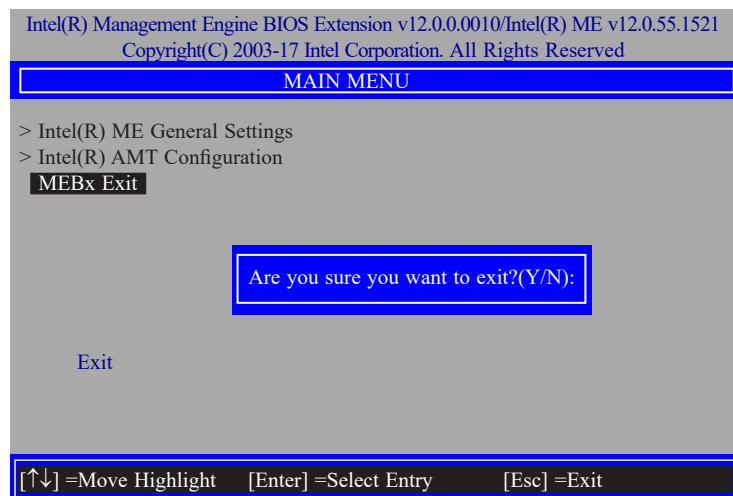

## Chapter 5 - RAID

The system board allows configuring RAID on Serial ATA drives. It supports RAID 0, RAID 1, RAID 5 and RAID 10.

### ► RAID Levels

#### RAID 0 (Striped Disk Array without Fault Tolerance)

RAID 0 uses two new identical hard disk drives to read and write data in parallel, interleaved stacks. Data is divided into stripes and each stripe is written alternately between two disk drives. This improves the I/O performance of the drives at different channel; however it is not fault tolerant. A failed disk will result in data loss in the disk array.

#### RAID 1 (Mirroring Disk Array with Fault Tolerance)

RAID 1 copies and maintains an identical image of the data from one drive to the other drive. If a drive fails to function, the disk array management software directs all applications to the other drive since it contains a complete copy of the drive's data. This enhances data protection and increases fault tolerance to the entire system. Use two new drives or an existing drive and a new drive but the size of the new drive must be the same or larger than the existing drive.

#### RAID 5

RAID 5 stripes data and parity information across hard drives. It is fault tolerant and provides better hard drive performance and more storage capacity.

#### RAID 10 (Mirroring and Striping)

RAID 10 is a combination of data striping and data mirroring providing the benefits of both RAID 0 and RAID 1. Use four new drives or an existing drive and three new drives for this configuration.

RAID Level	Min. Drives	Protection	Description
RAID 0	2	None	Data striping without redundancy
RAID 1	2	Single Drive Failure	Disk mirroring
RAID 5	3	Single Drive Failure	Block-level data striping with distributed parity
RAID 10	4	1 Disk Per Mirrored Stripe (not same mirror)	Combination of RAID 0 (data striping) and RAID 1 (mirroring)

### ► Setup Procedure

To enable the RAID function, the following settings are required.

1. Install SATA drives.
2. Enable RAID in the Insyde BIOS.
3. Create a RAID volume.
4. Install the Intel Rapid Storage Technology Utility.

#### Step 1: Install SATA Drives

Refer to chapter 2 for details on connecting the Serial ATA drives.



#### Important:

1. Please make sure the SATA drives that you are to create a RAID volume with are connected and powered, and are able to be detected by the system. Otherwise, the RAID BIOS utility would not be accessible.
2. While creating a RAID volume, please make sure the system, drives, and cables are perfectly steady and mounted correctly. Disturbance during creating a RAID volume will result in irreversible data corruption stored on the drive.

#### Step 2: Enable RAID in the AMI BIOS

1. Power-on the system then press <Del> to enter the main menu of the AMI BIOS.
2. Go to "Chipset" menu and select the "PCH-IO Configuration" menu then "SATA And RST Configuration" menu.
3. Change the "SATA Mode Selection" to "Intel RST Premium With Intel Optane System Acceleration" mode.
4. Press F10 to save the changes.
5. Reboot the system.

### Step 3: Create a RAID Volume

1. Go to the “Advanced” menu of the AMI BIOS and select “Intel(R) Rapid Storage Technology”.

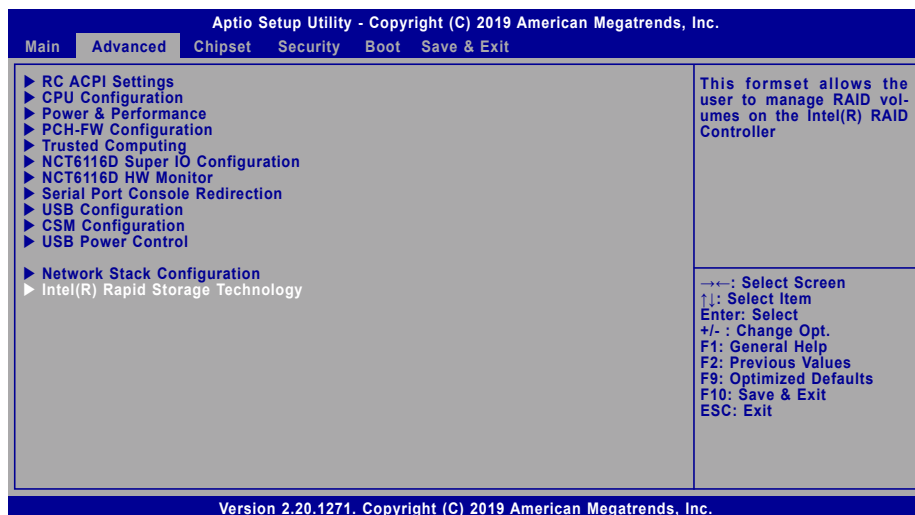

2. The screen displays all available drives. Select “Create RAID volume” to create a RAID volume”.
3. Use the up or down arrow keys to select the RAID level and press <Enter>.
4. Use the up or down arrow keys to scroll through the list of hard drives and press <Enter> to select the drive.
5. Press <Enter>.
6. Use the up or down arrow keys to select the strip size and press <Enter>.
7. Enter the volume size and press <Enter>.
8. At the prompt, press <Y> to confirm volume creation.

### Step 4: Install the Intel Rapid Storage Technology Utility

The Intel Rapid Storage Technology Utility can be installed from within Windows. It allows RAID volume management (create, delete, migrate) from within the operating system. It will also display useful SATA device and RAID volume information. The user interface, tray icon service and monitor service allow you to monitor the current status of the RAID volume and/or SATA drives. It enables enhanced performance and power management for the storage subsystem.

# Chapter 6 - Supported Software

Install drivers, utilities and software applications that are required to facilitate and enhance the performance of the system board. You may acquire the software from your sales representatives, from an optional DVD included in the shipment, or from the website download page at <https://www.dfi.com/DownloadCenter>.

## ► Auto-run Menu

After inserting your DVD-ROM into your optical drive or executing your DVD image, the System Utility auto-run menu may pop up. Click on the utility or driver that is to be installed on the system. Please refer to the following sections that correspond to your selection for more information.

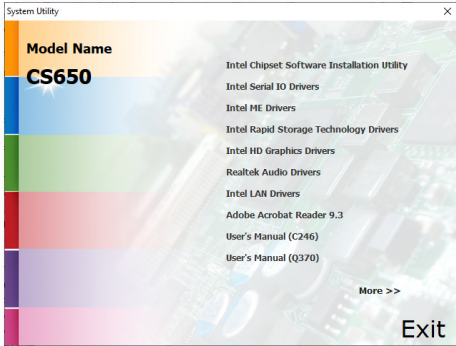

Click "More >>" on the lower right to go to the next page of the auto-run menu, and click "<< Previous" to return to the previous menu.

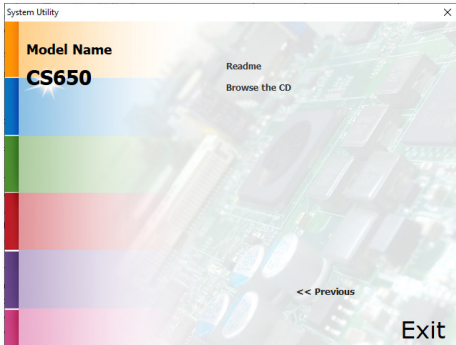

**Note:**  
This step can be ignored if the applications are downloaded standalone files.

## ► Intel Chipset Software Installation Utility

The Intel Chipset Software Installation Utility is used for updating Windows® INF files so that the Intel chipset can be recognized and configured properly in the system.

- 1. Setup is ready to install the utility. Click "Next".

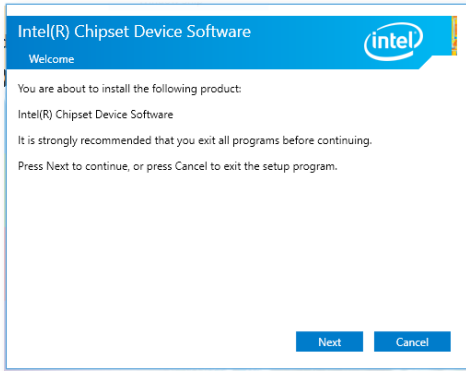

- 2. Read the license agreement then click "Accept".

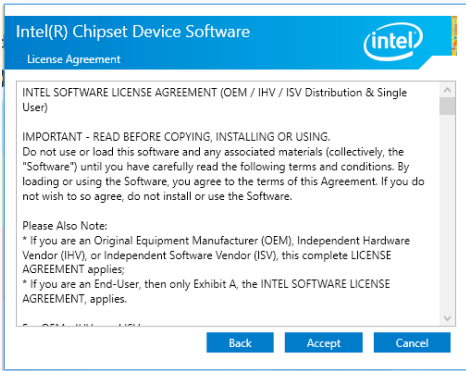

- 3. Go through the readme document for more installation tips then click "Install".

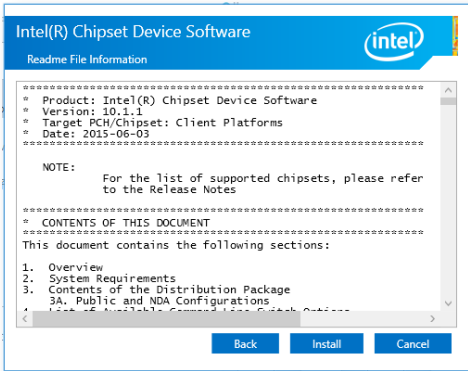

- 4. The step displays the installing status in the progress.

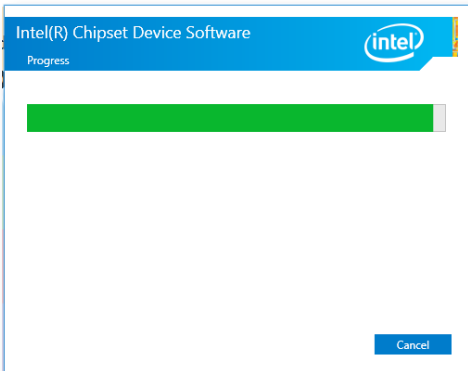

- 5. After completing installation, click "Restart Now" to exit setup.

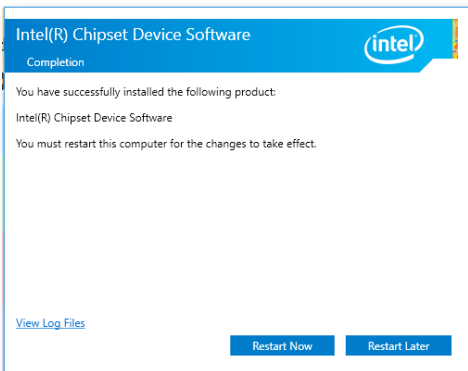

Restarting the system will allow the new software installation to take effect.

► Intel HD Graphics Drivers

- 1. Setup is now ready to install the graphics driver. Click "Next".

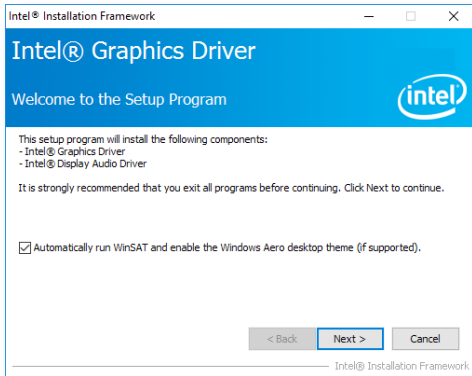

By default, the "Automatically run WinSAT and enable the Windows Aero desktop theme" is enabled. With this enabled, after installing the graphics driver and the system rebooted, the screen will turn blank for 1 to 2 minutes (while WinSAT is running) before the Windows 10 desktop appears. The "blank screen" period is the time Windows is testing the graphics performance.

We recommend that you skip this process by disabling this function then click "Next".

- 2. Read the license agreement then click "Yes".

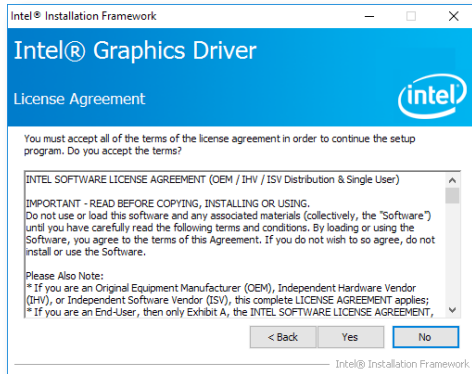



- Go through the readme document for system requirements and installation tips then click "Next".

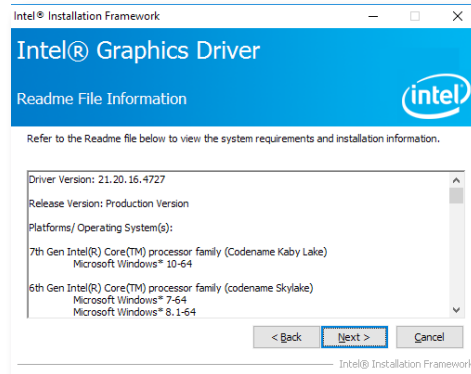

- Setup is now installing the driver. Click "Next" to continue.

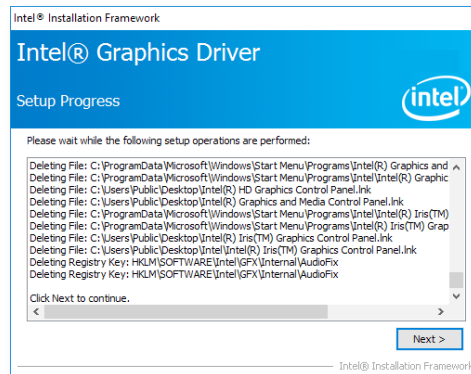

- Click "Yes, I want to restart this computer now" then click "Finish".

Restarting the system will allow the new software installation to take effect.

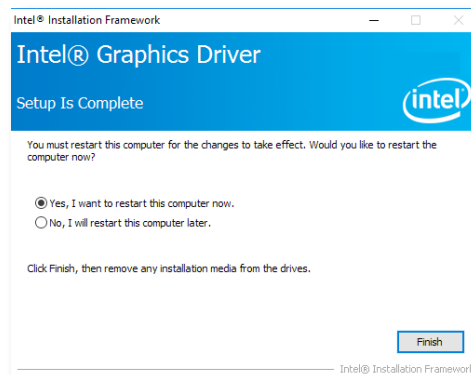

## ► Realtek Audio Drivers

- Setup is ready to install the driver. Click "Next".

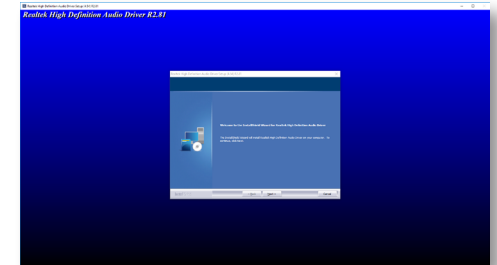

- Click "Yes, I want to restart my computer now" then click "Finish".

Restarting the system will allow the new software installation to take effect.

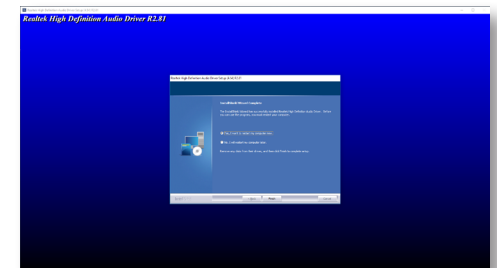

► Intel LAN Driver

1. Setup is ready to install the driver. Click “Next”.

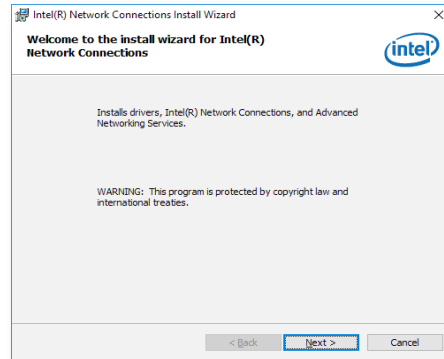

2. Click “I accept the terms in the license agreement” then click “Next”.

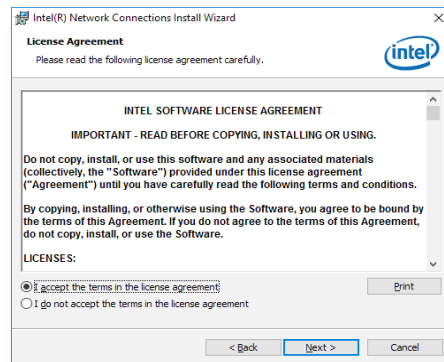

3. Select the program features you want installed then click “Next”.

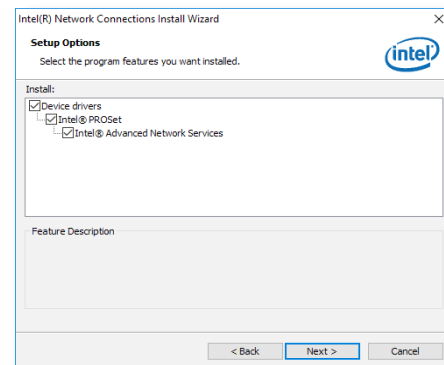

4. Click “Install” to begin the installation.

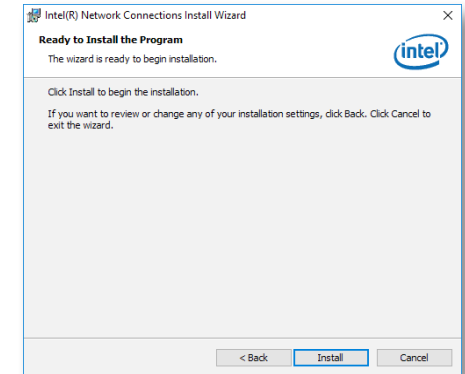

5. The step displays the installing status in the progress.

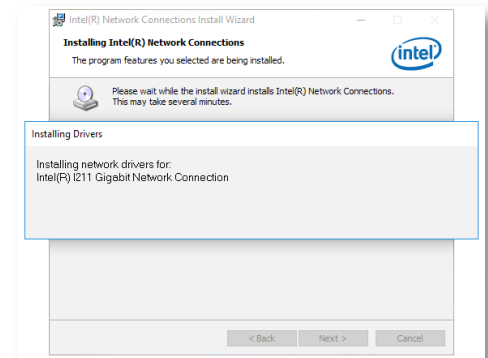

6. After completing installation, click “Finish”.

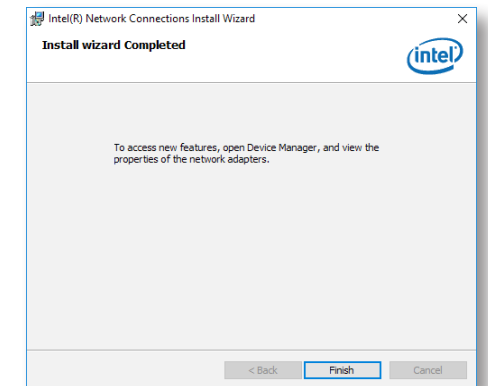

► Intel ME Drivers

1. Setup is ready to install the driver. Click “Next”.

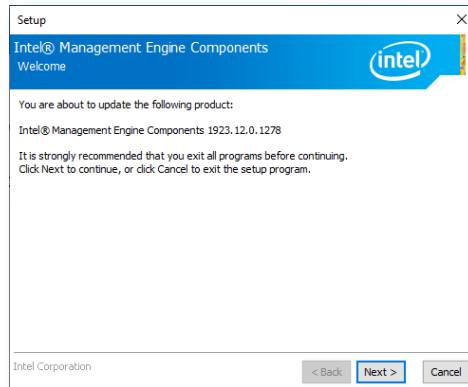

2. Read the license agreement then tick “I accept the terms in the License Agreement”. Click “Next”.

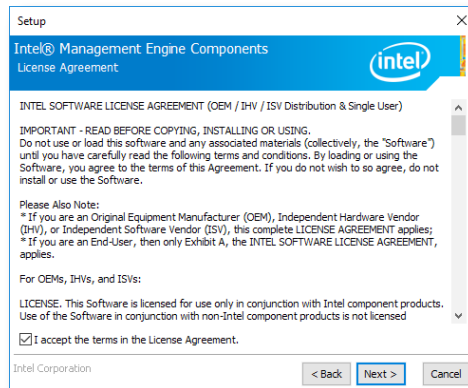

3. Click “Next” to install to the default folder, or click “Change” to choose another destination folder.

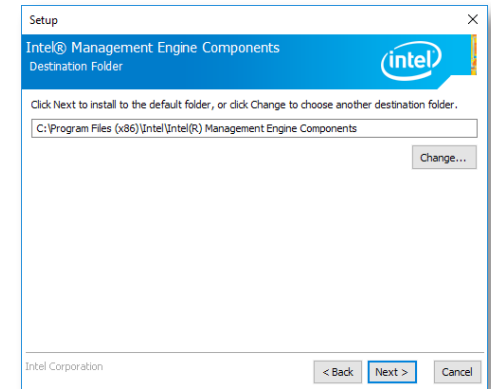

4. Please wait while the product is being installed.

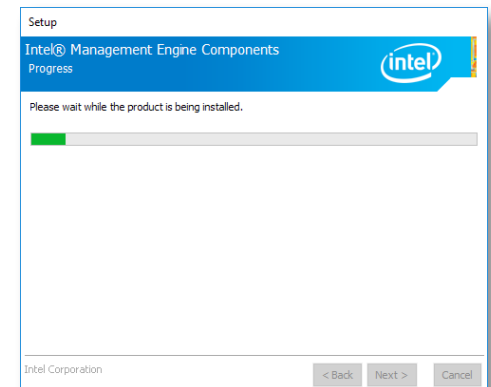

5. After completing installation, click “Finish”.

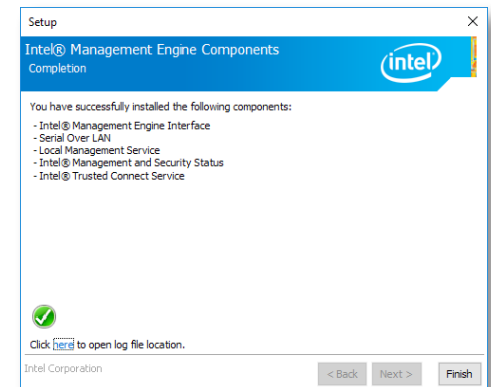

► Intel Serial IO Drivers

1. Setup is ready to install the driver. Click “Next”.

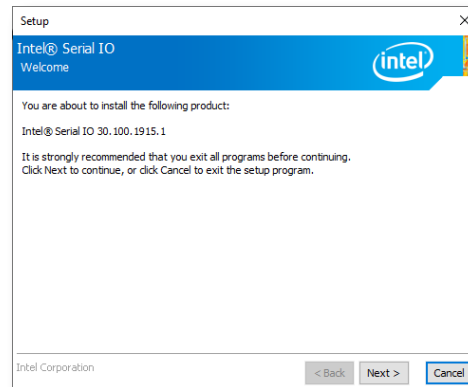

2. Read the license agreement carefully.  
Tick “I accept the terms in the License Agreement” then click “Next”.

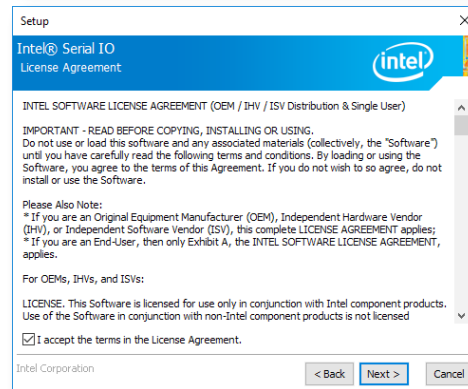

3. Go through the readme document for system requirements and installation tips then click “Next”.

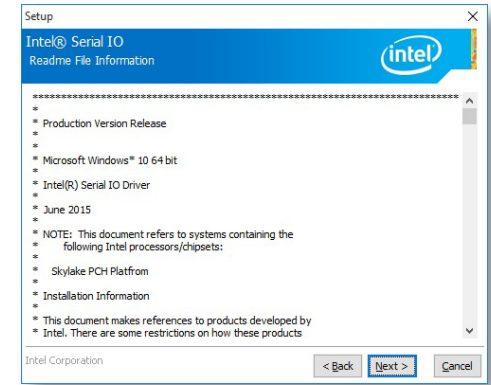

4. Setup is ready to install the driver. Click “Next”.

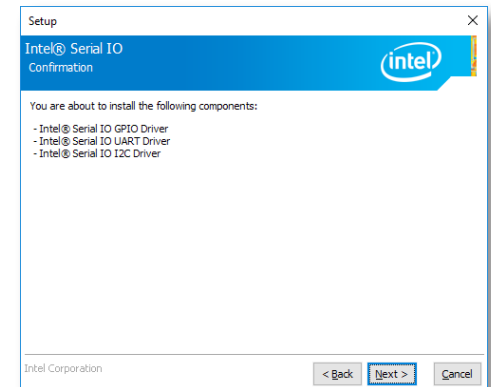

5. Setup is now installing the driver.

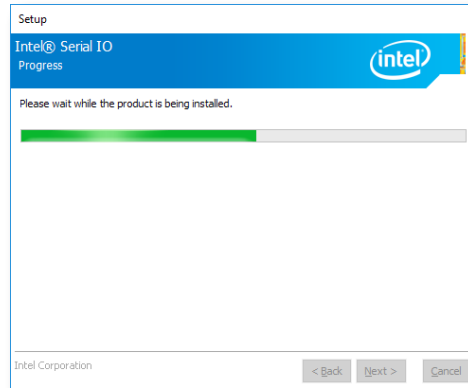

6. Click “Yes, I want to restart this computer now” then click “Finish”.

Restarting the system will allow the new software installation to take effect.

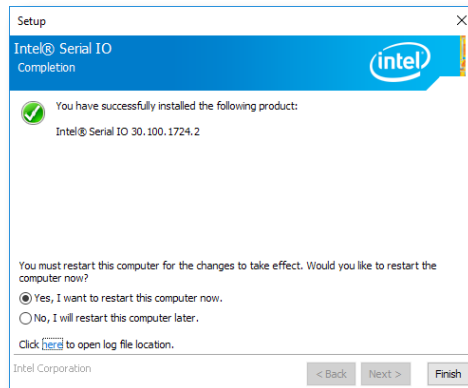

## ► Intel Rapid Storage Technology

The Intel Rapid Storage Technology is a utility that allows you to monitor the current status of the SATA drives. It enables enhanced performance and power management for the storage subsystem.

1. Setup is ready to install the utility. Click “Next”.

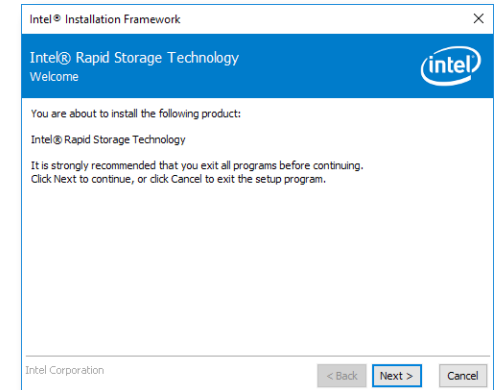

2. Read the license agreement and click “I accept the terms in the License Agreement”. Then, click “Next”.

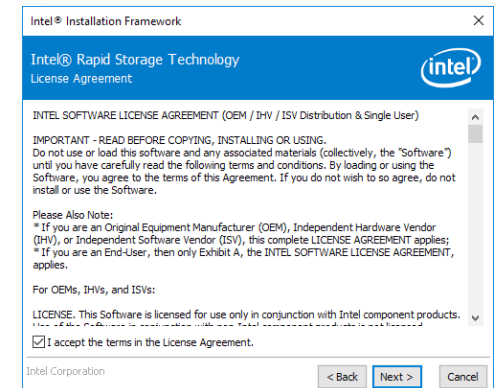

- Go through the readme document to view system requirements and installation information then click "Next".

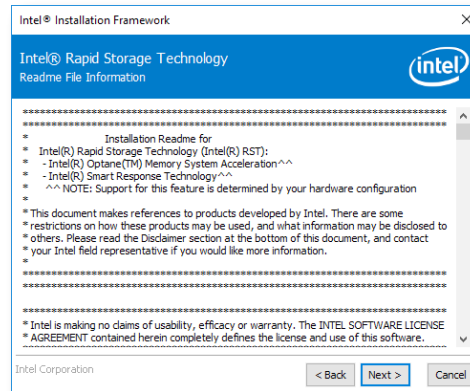

- Click "Next" to install to the default folder or click "Change" to choose another destination folder".

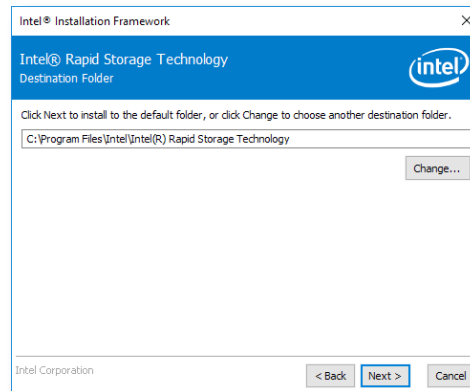

- Confirm the installation and click "Next".

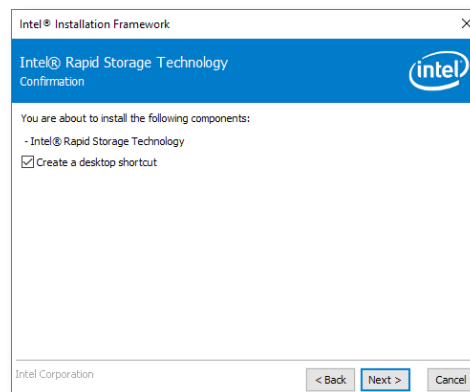

- Click "Yes, I want to restart this computer now" to complete the installation and then click "Finish".

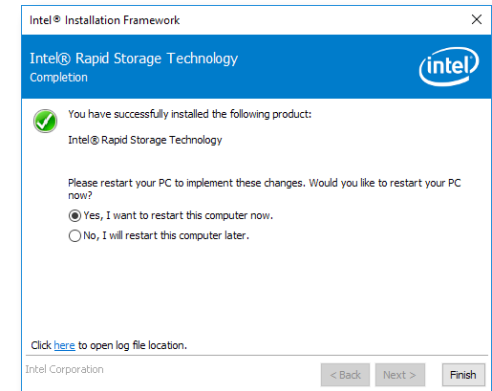

## ► Adobe Acrobat Reader 9.3

1. Click "Next" to install or click "Change Destination Folder" to select another folder.

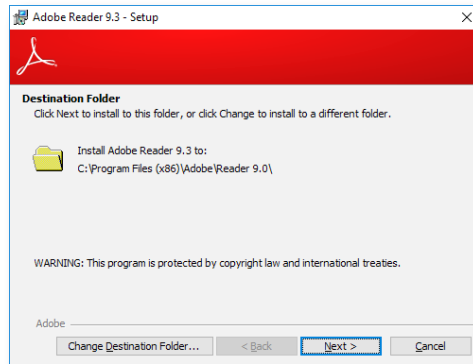

3. Setup is now installing the driver.

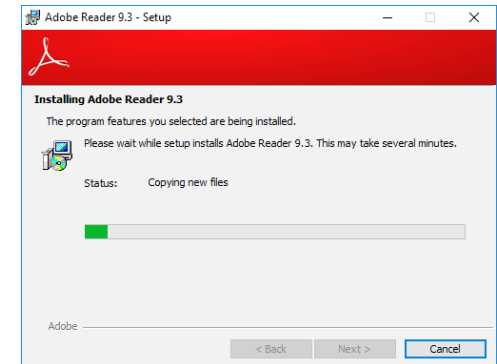

2. Click "Install" to begin installation.

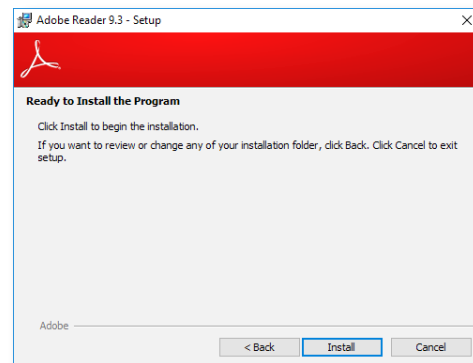

4. Click "Finish" to exit installation.

