



CR902-B/BL Series

COM Express Basic Module
User's Manual

Copyright

This publication contains information that is protected by copyright. No part of it may be reproduced in any form or by any means or used to make any transformation/adaptation without the prior written permission from the copyright holders.

This publication is provided for informational purposes only. The manufacturer makes no representations or warranties with respect to the contents or use of this manual and specifically disclaims any express or implied warranties of merchantability or fitness for any particular purpose. The user will assume the entire risk of the use or the results of the use of this document. Further, the manufacturer reserves the right to revise this publication and make changes to its contents at any time, without obligation to notify any person or entity of such revisions or changes.

Changes after the publication's first release will be based on the product's revision. The website will always provide the most updated information.

© 2014. All Rights Reserved.

Trademarks

Product names or trademarks appearing in this manual are for identification purpose only and are the properties of the respective owners.

COM Express Specification Reference

PICMG® COM Express Module™ Base Specification.

<http://www.picmg.org/>

FCC and DOC Statement on Class B

This equipment has been tested and found to comply with the limits for a Class B digital device, pursuant to Part 15 of the FCC rules. These limits are designed to provide reasonable protection against harmful interference when the equipment is operated in a residential installation. This equipment generates, uses and can radiate radio frequency energy and, if not installed and used in accordance with the instruction manual, may cause harmful interference to radio communications. However, there is no guarantee that interference will not occur in a particular installation. If this equipment does cause harmful interference to radio or television reception, which can be determined by turning the equipment off and on, the user is encouraged to try to correct the interference by one or more of the following measures:

- Reorient or relocate the receiving antenna.
- Increase the separation between the equipment and the receiver.
- Connect the equipment into an outlet on a circuit different from that to which the receiver is connected.
- Consult the dealer or an experienced radio TV technician for help.

Notice:

1. The changes or modifications not expressly approved by the party responsible for compliance could void the user's authority to operate the equipment.
2. Shielded interface cables must be used in order to comply with the emission limits.

Table of Contents

Copyright.....	2
Trademarks.....	2
FCC and DOC Statement on Class B.....	2
About this Manual.....	4
Warranty.....	4
Static Electricity Precautions.....	4
Safety Measures.....	4
About the Package.....	5
Chapter 1 - Introduction.....	6
Specifications.....	6
Features.....	7
Chapter 2 - Concept.....	8
COM Express Module Standards.....	8
Specification Comparison Table.....	9
Chapter 3 - Hardware Installation.....	10
Board Layout.....	10
Block Diagram.....	10
Mechanical Diagram.....	11
System Memory.....	12
Installing the DIMM Module.....	13
Connectors.....	14
CPU Fan Connector.....	14
COM Express Connectors.....	15
COM Express connector Signal Discription.....	17
Standby Power LED.....	27
Cooling Option.....	27
Installing CR902-B/BL Series onto a Carrier Board.....	28

Chapter 4 - BIOS Setup.....	31
Overview.....	31
AMI BIOS Setup Utility.....	32
Main.....	32
Advanced.....	32
Chipset.....	39
Boot.....	45
Security.....	46
Save & Exit.....	46
Updating the BIOS.....	47
Notice: BIOS SPI ROM.....	47
Chapter 5 - Supported Software.....	48
Appendix A - nLite and AHCI Installation Guide.....	62
nLite.....	62
AHCI.....	66
Appendix B - Watchdog Sample Code.....	68
Appendix C - System Error Message.....	69
Appendix D - Troubleshooting.....	70

About this Manual

An electronic file of this manual is included in the CD. To view the user's manual in the CD, insert the CD into a CD-ROM drive. The autorun screen (Main Board Utility CD) will appear. Click "User's Manual" on the main menu.

Warranty

1. Warranty does not cover damages or failures that arised from misuse of the product, inability to use the product, unauthorized replacement or alteration of components and product specifications.
2. The warranty is void if the product has been subjected to physical abuse, improper installation, modification, accidents or unauthorized repair of the product.
3. Unless otherwise instructed in this user's manual, the user may not, under any circumstances, attempt to perform service, adjustments or repairs on the product, whether in or out of warranty. It must be returned to the purchase point, factory or authorized service agency for all such work.
4. We will not be liable for any indirect, special, incidental or consequential damages to the product that has been modified or altered.

Static Electricity Precautions

It is quite easy to inadvertently damage your PC, system board, components or devices even before installing them in your system unit. Static electrical discharge can damage computer components without causing any signs of physical damage. You must take extra care in handling them to ensure against electrostatic build-up.

1. To prevent electrostatic build-up, leave the system board in its anti-static bag until you are ready to install it.
2. Wear an antistatic wrist strap.
3. Do all preparation work on a static-free surface.
4. Hold the device only by its edges. Be careful not to touch any of the components, contacts or connections.
5. Avoid touching the pins or contacts on all modules and connectors. Hold modules or connectors by their ends.



Important:

Electrostatic discharge (ESD) can damage your processor, disk drive and other components. Perform the upgrade instruction procedures described at an ESD workstation only. If such a station is not available, you can provide some ESD protection by wearing an antistatic wrist strap and attaching it to a metal part of the system chassis. If a wrist strap is unavailable, establish and maintain contact with the system chassis throughout any procedures requiring ESD protection.

Safety Measures

To avoid damage to the system:

- Use the correct AC input voltage range.

To reduce the risk of electric shock:

- Unplug the power cord before removing the system chassis cover for installation or servicing. After installation or servicing, cover the system chassis before plugging the power cord.

About the Package

The package contains the following items. If any of these items are missing or damaged, please contact your dealer or sales representative for assistance.

- One CR902 board
- One DVD
- One QR (Quick Reference)

Optional Items

- COM330-B carrier board kit
- Heat spreader with heat sink and fan

The board and accessories in the package may not come similar to the information listed above. This may differ in accordance with the sales region or models in which it was sold. For more information about the standard package in your region, please contact your dealer or sales representative.

Before Using the System Board

Before using the system board, prepare basic system components.

If you are installing the system board in a new system, you will need at least the following internal components.

- A CPU
- Memory module
- Storage devices such as hard disk drive, CD-ROM, etc.

You will also need external system peripherals you intend to use which will normally include at least a keyboard, a mouse and a video display monitor.

Chapter 1 - Introduction

Specifications

Processor	<ul style="list-style-type: none"> BGA 1023 packaging technology 3rd generation Intel® Core™ processors (22nm process technology) <ul style="list-style-type: none"> Intel® Core™ i7-3615QE, (6M Cache, up to 3.30 GHz); 45W Intel® Core™ i7-3612QE, (6M Cache, up to 3.10 GHz); 35W Intel® Core™ i7-3555LE, (4M Cache, up to 3.20 GHz); 25W Intel® Core™ i7-3517UE, (4M Cache, up to 2.80 GHz); 17W Intel® Core™ i5-3610ME, (3M Cache, up to 3.30 GHz); 35W Intel® Core™ i3-3120ME, (3M Cache, 2.40 GHz); 35W Intel® Core™ i3-3217UE, (3M Cache, 1.60 GHz); 17W Intel® Celeron™ 1020E, (2M Cache, 2.20 GHz); 35W Intel® Celeron™ 1047UE, (2M Cache, 1.40 GHz); 17W Intel® Celeron™ 927UE, (1M Cache, 1.50 GHz); 17W 2nd generation Intel® Core™ processors (32nm process technology) <ul style="list-style-type: none"> Intel® Core™ i7-2715QE, (6M Cache, up to 3.00 GHz); 45W Intel® Core™ i7-2655LE, (4M Cache, up to 2.90 GHz); 25W Intel® Core™ i7-2610UE, (4M Cache, up to 2.40 GHz); 17W Intel® Core™ i5-2515E, (3M Cache, up to 3.10 GHz); 35W Intel® Core™ i3-2310E, (3M Cache, 2.10 GHz); 35W Intel® Core™ i3-2340UE, (3M Cache, 1.30 GHz); 17W Intel® Celeron™ B810E (2M Cache, 1.6GHz); 35W Intel® Celeron™ 847E (2M Cache, 1.1GHz); 17W Intel® Celeron™ 827E (1.5M Cache, 1.4GHz); 17W Intel® Celeron™ 807UE, (1M Cache, 1.00 GHz); 10W
Chipset	<ul style="list-style-type: none"> Intel® QM77 Express Chipset (-B) Intel® HM76 Express Chipset (-BL)
System Memory	<ul style="list-style-type: none"> Two 204-pin DDR3/DDR3L SODIMM sockets 3rd generation processors <ul style="list-style-type: none"> Supports DDR3/DDR3L 1333/1600 MHz (i7/i5/i3) Supports DDR3/DDR3L 1067/1333/1600 MHz (i7 Quad Core) 2nd generation processors <ul style="list-style-type: none"> Supports DDR3 1066/1333 MHz (i7/i5/i3/Celeron) Supports DDR3 1066/1333/1600 MHz (i7 Quad Core) Supports dual channel memory interface Supports up to 16GB system memory DRAM device technologies: 1Gb, 2Gb and 4Gb DDR3 DRAM technologies are supported for x8 and x16 devices, unbuffered, non-ECC
Graphics	<ul style="list-style-type: none"> Intel® HD Graphics 4000 (3rd generation processors) Intel® HD Graphics 3000 (2nd generation processors) Intel® HD Graphics (Intel® Celeron™ processors) Supports LVDS, VGA and DDI interfaces VGA: resolution up to 2048x1536 @ 75Hz LVDS: Single Channel - 18/24-bit; Dual Channel - 36/48-bit, resolution up to 1920x1200 @ 60Hz Digital Display Interfaces: HDMI, DVI, DP or SDVO HDMI, DVI, DP, SDVO: resolution up to 1920x1200 @ 60Hz Intel® Clear Video Technology DirectX Video Acceleration (DXVA) for accelerating video processing <ul style="list-style-type: none"> Full AVC/VC1/MPEG2 HW Decode Supports DirectX 11/10.1/10/9 and OpenGL 3.0 (3rd generation processors) Supports DirectX 10.1/10/9 and OpenGL 3.0 (2nd generation processors)
Audio	<ul style="list-style-type: none"> Supports High Definition Audio interface

LAN	<ul style="list-style-type: none"> Intel® 82579LM Gigabit Ethernet PHY Integrated 10/100/1000 transceiver Fully compliant with IEEE 802.3, IEEE 802.3u, IEEE 802.3ab
Serial ATA	<ul style="list-style-type: none"> Supports 4 Serial ATA interfaces 2 SATA 3.0 with data transfer rate up to 6Gb/s 2 SATA 2.0 with data transfer rate up to 3Gb/s Integrated Advanced Host Controller Interface (AHCI) controller Supports RAID 0/1/5/10 (CR902-B Series only)
Expansion Interfaces	<ul style="list-style-type: none"> Supports 8 USB 2.0 ports Supports 1 PCIe x16 interface (multiplex digital display interface) Supports 2 DDI (multiplex with PCIe x16) <ul style="list-style-type: none"> Port B for SDVO / HDMI / DVI Port C for HDMI/DVI/DisplayPort Supports 1 PCIe x4 and 1 PCIe x1 (default); or 5 PCIe x1 interfaces Supports 4 PCI interfaces (PCI 2.3 interface) Supports LPC interface Supports SMBus interface Supports IDE interface Supports 8-bit Digital I/O
IDE Interface	<ul style="list-style-type: none"> Supports up to two IDE devices DMA mode: Ultra ATA up to 100MB/s PIO mode: up to 16MB/s
Damage Free Intelligence	<ul style="list-style-type: none"> Monitors CPU temperature and overheat alarm Monitors CPU fan speed and failure alarm Monitors Vcore/VCCRTC/DDR/+1.05V/VCCSA voltages and failure alarm Watchdog timer function
BIOS	<ul style="list-style-type: none"> 64Mbit SPI BIOS
OS Support	<ul style="list-style-type: none"> Windows XP Professional x86 & SP3 (32-bit) Windows XP Professional x64 & SP2 (64-bit) Windows 7 Ultimate x86 & SP1 (32-bit) Windows 7 Ultimate x64 & SP1 (64-bit) Windows 8 Enterprise x86 (32-bit) Windows 8 Enterprise x64 (64-bit)
Temperature	<ul style="list-style-type: none"> 0°C to 60°C
Humidity	<ul style="list-style-type: none"> 10% to 90%
Power	<ul style="list-style-type: none"> Input: 5VSB (option), 12V, VCC_RTC
PCB	<ul style="list-style-type: none"> Dimensions: 95mm (3.74") x 125mm (4.9") Compliance: PICMG COM Express® R2.1 basic form factor, Type 2
Certification	<ul style="list-style-type: none"> CE FCC Class B RoHS

Features

• Watchdog Timer

The Watchdog Timer function allows your application to regularly “clear” the system at the set time interval. If the system hangs or fails to function, it will reset at the set time interval so that your system will continue to operate.

• DDR3

DDR3 delivers increased system bandwidth and improved performance. The advantages of DDR3 are its higher bandwidth and its increase in performance at a lower power than DDR2.

• Graphics

The integrated Intel® HD graphics engine delivers an excellent blend of graphics performance and features to meet business needs. It provides excellent video and 3D graphics with outstanding graphics responsiveness. These enhancements deliver the performance and compatibility needed for today's and tomorrow's business applications. Supports LVDS, VGA and DDI display outputs.

• Serial ATA

Serial ATA is a storage interface that is compliant with SATA 1.0a specification. With speed of up to 3Gb/s (SATA 2.0) and 6Gb/s (SATA 3.0), it improves hard drive performance faster than the standard parallel ATA whose data transfer rate is 100MB/s. The bandwidth of the SATA 3.0 will be limited by carrier board design.

• Gigabit LAN

The Intel 82579LM Gigabit LAN controller supports up to 1Gbps data transmission.

Chapter 2 - Concept

COM Express Module Standards

The figure below shows the dimensions of the different types of COM Express modules.

CR902-B/BL series is a COM Express Basic module. The dimension is 95mm x 125mm.

- ⊙ Common for all Form Factors
- ⊖ Extended only
- Basic only
- ⊕ Compact only
- ⊗ Compact and Basic only
- ⊘ Mini only

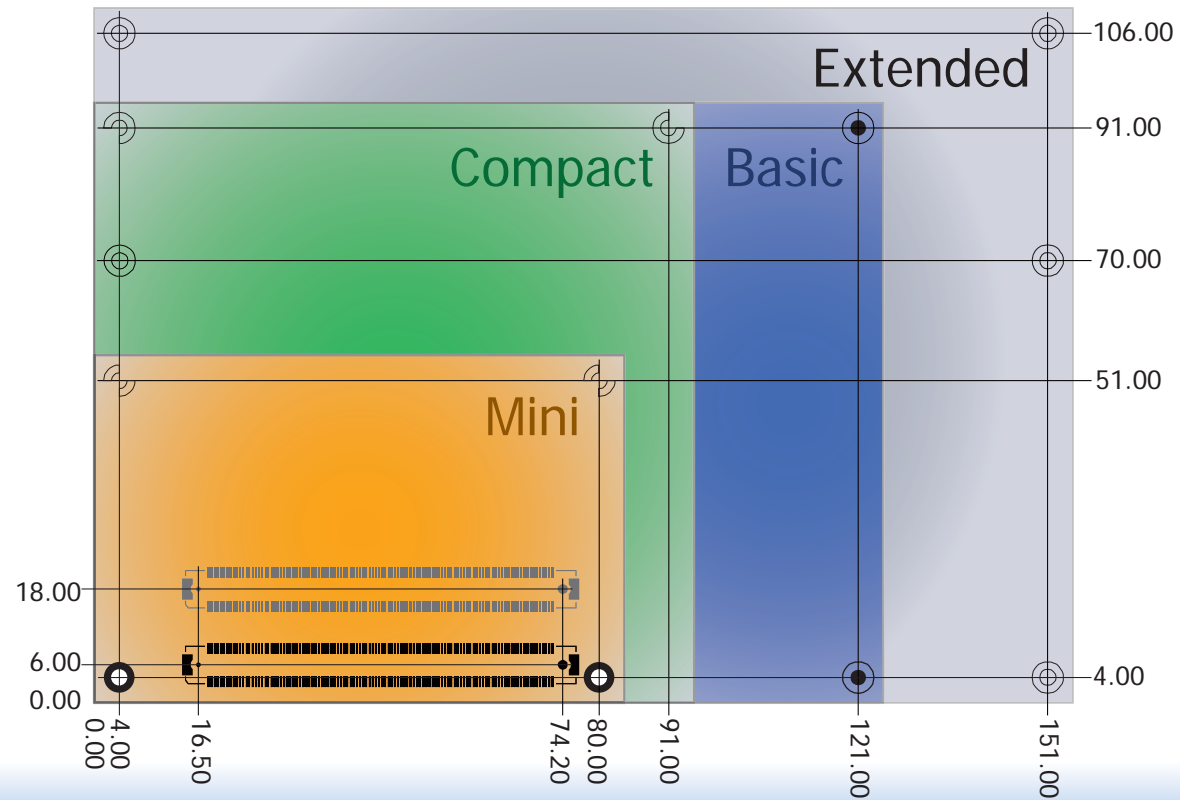

Specification Comparison Table

The table below shows the COM Express standard specifications and the corresponding specifications supported on the CR902-B/BL series module.

Connector	Feature	COM Express Module Base Specification Type 2 (IDE + PCI) Min / Max	DFI CR902-B/BL Series Type 2
System I/O			
A-B	PCI Express Lanes 0 - 5	1 / 6	5
A-B	LVDS Channel A	0 / 1	1
A-B	LVDS Channel B	0 / 1	1
A-B	eDP on LVDS CH A pins	NA	NA
A-B	VGA Port	0 / 1	1
A-B	TV-Out	NA	NA
A-B	DDI 0	NA	NA
A-B ⁵	Serial Ports 1 - 2	NA	NA
A-B	CAN interface on SER1	NA	NA
A-B	SATA / SAS Ports	1 / 4	4
A-B	AC'97 / HDA Digital Interface	0 / 1	1
A-B	USB 2.0 Ports	4 / 8	8
A-B	USB Client	0 / 1	0
A-B	USB 3.0 Ports	NA	NA
A-B	LAN Port 0	1 / 1	1
A-B	Express Card Support	1 / 2	2
A-B	LPC Bus	1 / 1	1
A-B	SPI	1 / 2	1
System Management			
A-B ⁶	SDIO (muxed on GPIO)	NA	NA
A-B ⁶	General Purpose I/O	8 / 8	8
A-B	SMBus	1 / 1	1
A-B	I2C	1 / 1	1
A-B	Watchdog Timer	0 / 1	1
A-B	Speaker Out	1 / 1	1
A-B	External BIOS ROM Support	0 / 2	1
A-B	Reset Functions	1 / 1	1

- 5 Indicates 12V-tolerant features on former VCC_12V signals.
- 6 Cells in the connected columns spanning rows provide a rough approximation of features sharing connector pins.

Connector	Feature	Type 2 (IDE + PCI) Min / Max	DFI CR902-B/BL Series Type 2
Power Management			
A-B	Thermal Protection	0 / 1	1
A-B	Battery Low Alarm	0 / 1	1
A-B	Suspend/Wake Signals	0 / 3	2
A-B	Power Button Support	1 / 1	1
A-B	Power Good	1 / 1	1
A-B	VCC_5V_SBY Contacts	4 / 4	4
A-B ⁵	Sleep Input	NA	NA
A-B ⁵	Lid Input	NA	NA
A-B ⁵	Fan Control Signals	NA	NA
A-B	Trusted Platform Modules	NA	NA
Power			
A-B	VCC_12V Contacts	12 / 12	12

Module Pin-out - Required and Optional Features C-D Connector. PICMG® COM.0Revision 2.1

Connector	Feature	Type 2 (IDE + PCI) Min / Max	DFI CR902-B/BL Series Type 2
System I/O			
C-D	PCI Express Lanes 16 - 31	0 / 16	0
C-D ⁶	PCI Express Graphics (PEG)	0 / 1	1
C-D ⁶	Muxed SDVO Channels 1 - 2	0 / 2	1
C-D ⁶	PCI Express Lanes 6 - 15	NA	NA
C-D ⁶	PCI Bus - 32 Bit	1 / 1	1
C-D ⁶	PATA Port	1 / 1	1
C-D ⁶	LAN Ports 1 - 2	NA	NA
C-D ⁶	DDIs 1 - 3	NA	NA
C-D ⁶	USB 3.0 Ports	NA	NA
Power			
C-D	VCC_12V Contacts	12 / 12	12

Chapter 3 - Hardware Installation

Board Layout

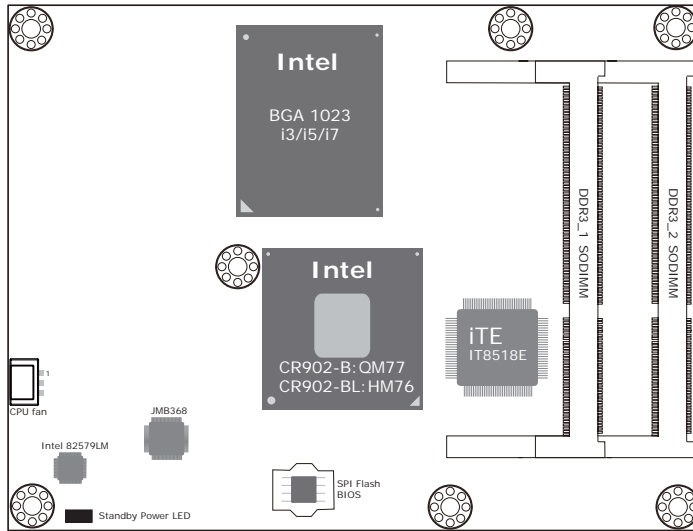

Top View

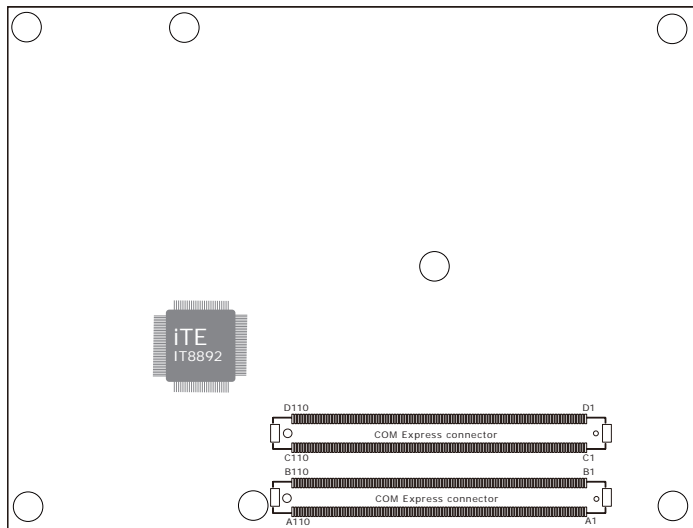

Bottom View

Block Diagram

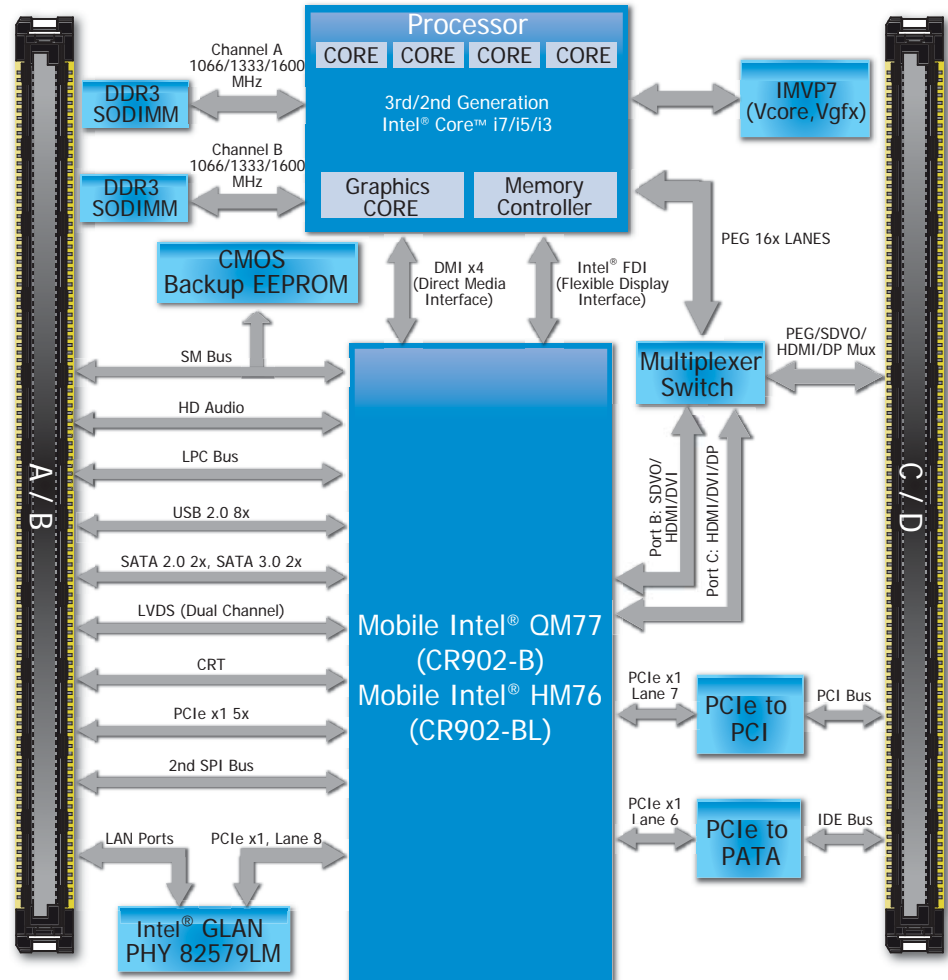

Mechanical Diagram

CR902-B/BL Series Module with Heat Sink

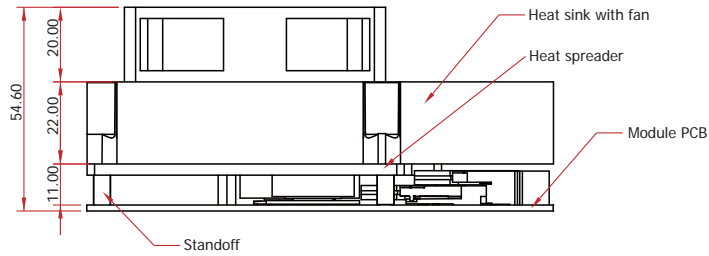
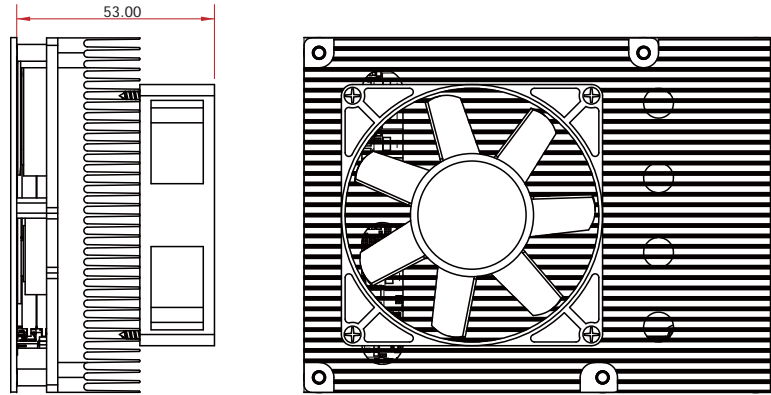

Side View of the Module with Heat Sink and Carrier Board

CR902-B/BL Series Module

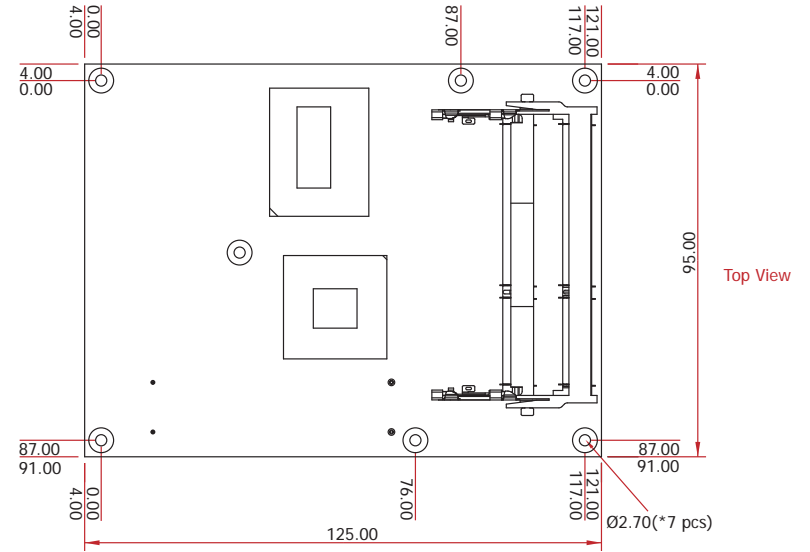

Top View

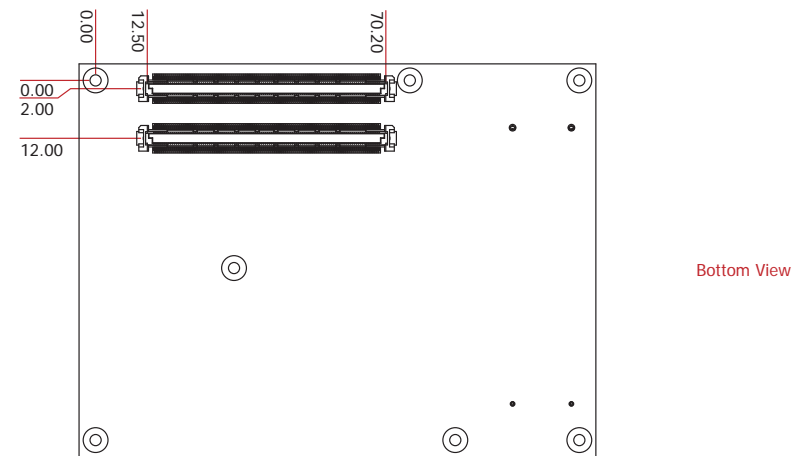

Bottom View

**Important:**

Electrostatic discharge (ESD) can damage your board, processor, disk drives, add-in boards, and other components. Perform installation procedures at an ESD workstation only. If such a station is not available, you can provide some ESD protection by wearing an antistatic wrist strap and attaching it to a metal part of the system chassis. If a wrist strap is unavailable, establish and maintain contact with the system chassis throughout any procedures requiring ESD protection.

System Memory

The system board is equipped with two 204-pin SODIMM sockets that support DDR3(1.5V)/DDR3L(1.35V) memory modules; depends on CPU supported. However, DDR3L memory module can run at 1.5V.

**Important:**

When the Standby Power LED lit red, it indicates that there is power on the board. Power-off the PC then unplug the power cord prior to installing any devices. Failure to do so will cause severe damage to the board and components.

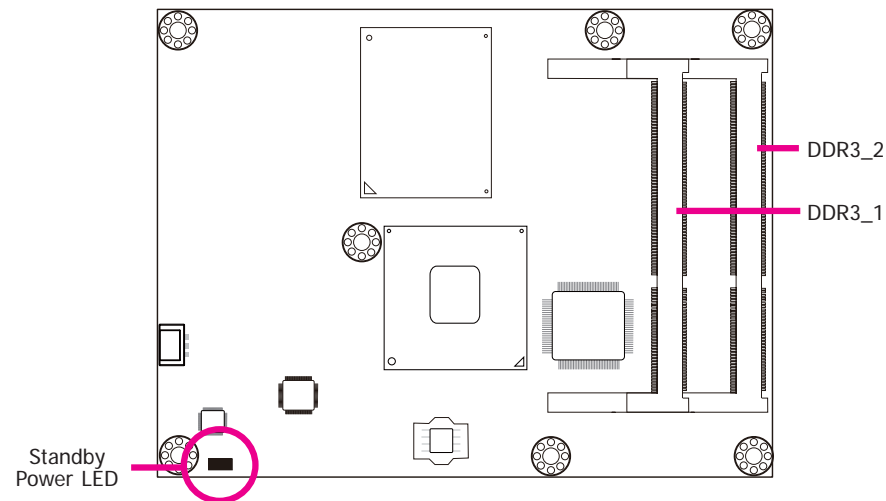

Installing the DIMM Module



Note:

The system board used in the following illustrations may not resemble the actual one. These illustrations are for reference only.

1. Make sure the PC and all other peripheral devices connected to it has been powered down.
2. Disconnect all power cords and cables.
3. Locate the SODIMM socket on the system board.
4. Note the key on the socket. The key ensures the module can be plugged into the socket in only one direction.

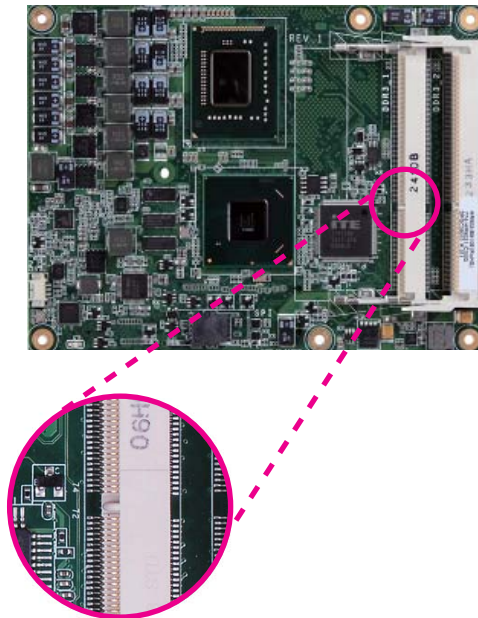

5. Grasping the module by its edges, align the module into the socket at an approximately 30 degrees angle. Apply firm even pressure to each end of the module until it slips down into the socket. The contact fingers on the edge of the module will almost completely disappear inside the socket.



6. Push down the module until the clips at each end of the socket lock into position. You will hear a distinctive “click”, indicating the module is correctly locked into position.



Connectors

CPU Fan Connector

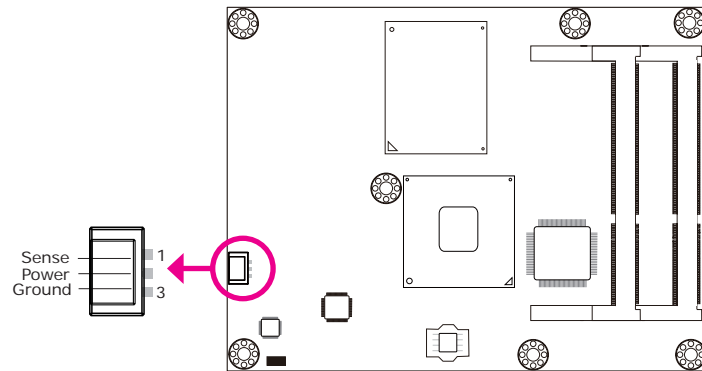

Connect the CPU fan's cable connector to the CPU fan connector on the board. The cooling fan will provide adequate airflow throughout the chassis to prevent overheating the CPU and board components.

BIOS Setting

"Module Board H/W Monitor" submenu in the Advanced menu of the BIOS will display the current speed of the cooling fan. Refer to chapter 3 of the manual for more information.

COM Express Connectors

The COM Express connectors are used to interface the CR902-B/BL Series COM Express board to a carrier board. Connect the COM Express connectors (located on the solder side of the board) to the COM Express connectors on the carrier board.

Refer to the "Installing CR902-B/BL Series onto a Carrier Board" section for more information.

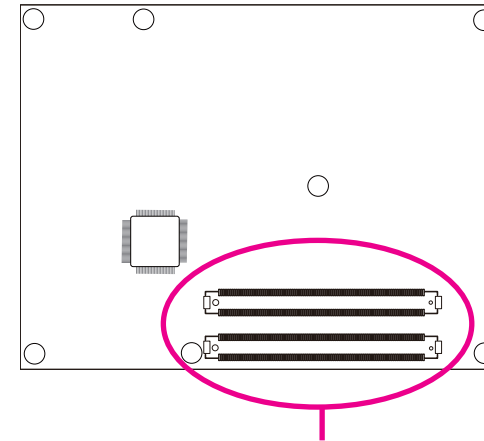

COM Express Connectors

Refer to the following pages for the pin functions of these connectors.

COM Express Connectors

Pin	Row A	Row B
1	GND(FIXED)	GND(FIXED)
2	GBE0_MDI3-	GBE0_ACT#
3	GBE0_MDI3+	LPC_FRAME#
4	GBE0_LINK100#	LPC_AD0
5	GBE0_LINK1000#	LPC_AD1
6	GBE0_MDI2-	LPC_AD2
7	GBE0_MDI2+	LPC_AD3
8	GBE0_LINK#	LPC_DRQ0#
9	GBE0_MDI1-	LPC_DRQ1#
10	GBE0_MDI1+	LPC_CLK
11	GND(FIXED)	GND(FIXED)
12	GBE0_MDI0-	PWRBTN#
13	GBE0_MDI0+	SMB_CK
14	GBE0_CTREF	SMB_DAT
15	SUS_S3#	SMB_ALERT#
16	SATA0_TX+	SATA1_TX+
17	SATA0_TX-	SATA1_TX-
18	SUS_S4#	SUS_STAT#
19	SATA0_RX+	SATA1_RX+
20	SATA0_RX-	SATA1_RX-
21	GND(FIXED)	GND(FIXED)
22	SATA2_TX+	SATA3_TX+
23	SATA2_TX-	SATA3_TX-
24	SUS_S5#	PWR_OK
25	SATA2_RX+	SATA3_RX+
26	SATA2_RX-	SATA3_RX-
27	BATLOW#	WDT
28	(S)ATA_ACT#	AC/HDA_SDIN2
29	AC/HDA_SYNC	AC/HDA_SDIN1
30	AC/HDA_RST#	AC/HDA_SDINO
31	GND(FIXED)	GND(FIXED)
32	AC/HDA_BITCLK	SPKR
33	AC/HDA_SDOUT	I2C_CK
34	BIOS_DIS0#	I2C_DAT
35	THRMTRIP#	THRM#
36	USB6-	USB7-
37	USB6+	USB7+
38	USB_6_7_OC#	USB_4_5_OC#
39	USB4-	USB5-
40	USB4+	USB5+

Pin	Row A	Row B
41	GND(FIXED)	GND(FIXED)
42	USB2-	USB3-
43	USB2+	USB3+
44	USB_2_3_OC#	USB_0_1_OC#
45	USB0-	USB1-
46	USB0+	USB1+
47	VCC_RTC	EXCD1_PERST#
48	EXCD0_PERST#	EXCD1_CPPE#
49	EXCD0_CPPE#	SYS_RESET#
50	LPC_SERIRQ	CB_RESET#
51	GND(FIXED)	GND(FIXED)
52	PCIE_TX5+	PCIE_RX5+
53	PCIE_TX5-	PCIE_RX5-
54	GPI0	GPO1
55	PCIE_TX4+	PCIE_RX4+
56	PCIE_TX4-	PCIE_RX4-
57	GND	GPO2
58	PCIE_TX3+	PCIE_RX3+
59	PCIE_TX3-	PCIE_RX3-
60	GND(FIXED)	GND(FIXED)
61	PCIE_TX2+	PCIE_RX2+
62	PCIE_TX2-	PCIE_RX2-
63	GPI1	GPO3
64	PCIE_TX1+	PCIE_RX1+
65	PCIE_TX1-	PCIE_RX1-
66	GND	WAKE0#
67	GPI2	WAKE1#
68	PCIE_TX0+	PCIE_RX0+
69	PCIE_TX0-	PCIE_RX0-
70	GND(FIXED)	GND(FIXED)
71	LVDS_A0+	LVDS_B0+
72	LVDS_A0-	LVDS_B0-
73	LVDS_A1+	LVDS_B1+
74	LVDS_A1-	LVDS_B1-
75	LVDS_A2+	LVDS_B2+
76	LVDS_A2-	LVDS_B2-
77	LVDS_VDD_EN	LVDS_B3+
78	LVDS_A3+	LVDS_B3-
79	LVDS_A3-	LVDS_BKLT_EN
80	GND(FIXED)	GND(FIXED)

Pin	Row A	Row B
81	LVDS_A_CK+	LVDS_B_CK+
82	LVDS_A_CK-	LVDS_B_CK-
83	LVDS_I2C_CK	LVDS_BKLT_CTRL
84	LVDS_I2C_DAT	VCC_5V_SBY
85	GPI3	VCC_5V_SBY
86	KBD_RST#	VCC_5V_SBY
87	KBD_A20GATE	VCC_5V_SBY
88	PCIE_CLK_REF+	BIOS_DIS1#
89	PCIE_CLK_REF-	VGA_RED
90	GND(FIXED)	GND(FIXED)
91	SPI_POWER	VGA_GRN
92	SPI_MISO	VGA_BLU
93	GPO0	VGA_HSYNC
94	SPI_CLK	VGA_VSYNC
95	SPI_MOSI	VGA_I2C_CK
96	GND	VGA_I2C_DAT
97	TYPE10#	SPI_CS#
98	RSVD ¹⁶	RSVD ¹⁶
99	RSVD ¹⁶	RSVD
100	GND(FIXED)	GND(FIXED)
101	RSVD ¹⁶	RSVD ¹⁶
102	RSVD ¹⁶	RSVD ¹⁶
103	RSVD ¹⁶	RSVD ¹⁶
104	VCC_12V	VCC_12V
105	VCC_12V	VCC_12V
106	VCC_12V	VCC_12V
107	VCC_12V	VCC_12V
108	VCC_12V	VCC_12V
109	VCC_12V	VCC_12V
110	GND(FIXED)	GND(FIXED)

**Note:**

16 RSVD pins are reserved for future use and should be no connect. Do not tie the RSVD pins together.

Pin	Row C	Row D
1	GND(FIXED)	GND(FIXED)
2	IDE_D7	IDE_D5
3	IDE_D6	IDE_D10
4	IDE_D3	IDE_D11
5	IDE_D15	IDE_D12
6	IDE_D8	IDE_D4
7	IDE_D9	IDE_D0
8	IDE_D2	IDE_REQ
9	IDE_D13	IDE_IOW#
10	IDE_D1	IDE_ACK#
11	GND(FIXED)	GND(FIXED)
12	IDE_D14	IDE_IRQ
13	IDE_IORDY	IDE_A0
14	IDE_IOR#	IDE_A1
15	PCI_PME#	IDE_A2
16	PCI_GNT2#	IDE_CS1#
17	PCI_REQ2#	IDE_CS3#
18	PCI_GNT1#	IDE_RESET#
19	PCI_REQ1#	PCI_GNT3#
20	PCI_GNT0#	PCI_REQ3#
21	GND(FIXED)	GND(FIXED)
22	PCI_REQ0#	PCI_AD1
23	PCI_RESET#	PCI_AD3
24	PCI_AD0	PCI_AD5
25	PCI_AD2	PCI_AD7
26	PCI_AD4	PCI_C/BE0#
27	PCI_AD6	PCI_AD9
28	PCI_AD8	PCI_AD11
29	PCI_AD10	PCI_AD13
30	PCI_AD12	PCI_AD15
31	GND(FIXED)	GND(FIXED)
32	PCI_AD14	PCI_PAR
33	PCI_C/BE1#	PCI_SERR#
34	PCI_PERR#	PCI_STOP#
35	PCI_LOCK#	PCI_TRDY#
36	PCI_DEVSEL#	PCI_FRAME#
37	PCI_IRDY#	PCI_AD16
38	PCI_C/BE2#	PCI_AD18
39	PCI_AD17	PCI_AD20
40	PCI_AD19	PCI_AD22

Pin	Row C	Row D
41	GND(FIXED)	GND(FIXED)
42	PCI_AD21	PCI_AD24
43	PCI_AD23	PCI_AD26
44	PCI_C/BE3#	PCI_AD28
45	PCI_AD25	PCI_AD30
46	PCI_AD27	PCI_IRQC#
47	PCI_AD29	PCI_IRQD#
48	PCI_AD31	PCI_CLKRUN#
49	PCI_IRQA#	PCI_M66EN
50	PCI_IRQB#	PCI_CLK
51	GND(FIXED)	GND(FIXED)
52	PEG_RX0+	PEG_TX0+
53	PEG_RX0-	PEG_TX0-
54	TYPE0#	PEG_LANE_RV#
55	PEG_RX1+	PEG_TX1+
56	PEG_RX1-	PEG_TX1-
57	TYPE1#	TYPE2#
58	PEG_RX2+	PEG_TX2+
59	PEG_RX2-	PEG_TX2-
60	GND(FIXED)	GND(FIXED)
61	PEG_RX3+	PEG_TX3+
62	PEG_RX3-	PEG_TX3-
63	RSVD ¹⁶	RSVD ¹⁶
64	RSVD ¹⁶	RSVD ¹⁶
65	PEG_RX4+	PEG_TX4+
66	PEG_RX4-	PEG_TX4-
67	RSVD ¹⁶	GND
68	PEG_RX5+	PEG_TX5+
69	PEG_RX5-	PEG_TX5-
70	GND(FIXED)	GND(FIXED)
71	PEG_RX6+	PEG_TX6+
72	PEG_RX6-	PEG_TX6-
73	SDVO_DATA	SDVO_CLK
74	PEG_RX7+	PEG_TX7+
75	PEG_RX7-	PEG_TX7-
76	GND	GND
77	RSVD ¹⁶	IDE_CBLID#
78	PEG_RX8+	PEG_TX8+
79	PEG_RX8-	PEG_TX8-
80	GND(FIXED)	GND(FIXED)

Pin	Row C	Row D
81	PEG_RX9+	PEG_TX9+
82	PEG_RX9-	PEG_TX9-
83	RSVD ¹⁶	RSVD ¹⁶
84	GND	GND
85	PEG_RX10+	PEG_TX10+
86	PEG_RX10-	PEG_TX10-
87	GND	GND
88	PEG_RX11+	PEG_TX11+
89	PEG_RX11-	PEG_TX11-
90	GND(FIXED)	GND(FIXED)
91	PEG_RX12+	PEG_TX12+
92	PEG_RX12-	PEG_TX12-
93	GND	GND
94	PEG_RX13+	PEG_TX13+
95	PEG_RX13-	PEG_TX13-
96	GND	GND
97	RSVD ¹⁶	PEG_ENABLE#
98	PEG_RX14+	PEG_TX14+
99	PEG_RX14-	PEG_TX14-
100	GND(FIXED)	GND(FIXED)
101	PEG_RX15+	PEG_TX15+
102	PEG_RX15-	PEG_TX15-
103	GND	GND
104	VCC_12V	VCC_12V
105	VCC_12V	VCC_12V
106	VCC_12V	VCC_12V
107	VCC_12V	VCC_12V
108	VCC_12V	VCC_12V
109	VCC_12V	VCC_12V
110	GND(FIXED)	GND(FIXED)

 **Note:**
16 RSVD pins are reserved for future use and should be no connect. Do not tie the RSVD pins together.

COM Express Connectors Signal Description

Pin Types
 I Input to the Module
 O Output from the Module
 I/O Bi-directional input / output signal
 OD Open drain output

AC97/HDA Signals Descriptions

Signal	Pin#	Pin Type	Pwr Rail /Tolerance	PU/PD	Description
AC/HAD_RST#	A30	O CMOS	3.3V Suspend/3.3V		Reset output to CODEC, active low.
AC/HDA_SYNC	A29	O CMOS	3.3V/3.3V	PD 1MΩ	Sample-synchronization signal to the CODEC(s).
AC/HDA_BITCLK	A32	I/O CMOS	3.3V/3.3V		Serial data clock generated by the external CODEC(s).
AC/HDA_SDOUT	A33	O CMOS	3.3V/3.3V		Serial TDM data output to the CODEC.
AC/HDA_SDIN2	B28	I/O CMOS	3.3V Suspend/3.3V		Serial TDM data inputs from up to 3 CODECs.
AC/HDA_SDIN1	B29	I/O CMOS	3.3V Suspend/3.3V		
AC/HDA_SDIN0	B30	I/O CMOS	3.3V Suspend/3.3V		

Gigabit Ethernet Signals Descriptions

Signal	Pin#	Pin Type	Pwr Rail /Tolerance	PU/PD	Description																				
GBEO_MD10+	A13	I/O Analog	3.3V max Suspend		Gigabit Ethernet Controller 0: Media Dependent Interface Differential Pairs 0,1,2,3. The MDI can operate in 1000, 100 and 10 Mbit / sec modes. Some pairs are unused in some modes, per the following: <table border="0"> <tr> <td></td> <td>1000BASE-T</td> <td>100BASE-TX</td> <td>10BASE-T</td> </tr> <tr> <td>MDI[0]+/-</td> <td>B1_DA+/-</td> <td>TX+/-</td> <td>TX+/-</td> </tr> <tr> <td>MDI[1]+/-</td> <td>B1_DB+/-</td> <td>RX+/-</td> <td>RX+/-</td> </tr> <tr> <td>MDI[2]+/-</td> <td>B1_DC+/-</td> <td></td> <td></td> </tr> <tr> <td>MDI[3]+/-</td> <td>B1_DD+/-</td> <td></td> <td></td> </tr> </table>		1000BASE-T	100BASE-TX	10BASE-T	MDI[0]+/-	B1_DA+/-	TX+/-	TX+/-	MDI[1]+/-	B1_DB+/-	RX+/-	RX+/-	MDI[2]+/-	B1_DC+/-			MDI[3]+/-	B1_DD+/-		
	1000BASE-T	100BASE-TX	10BASE-T																						
MDI[0]+/-	B1_DA+/-	TX+/-	TX+/-																						
MDI[1]+/-	B1_DB+/-	RX+/-	RX+/-																						
MDI[2]+/-	B1_DC+/-																								
MDI[3]+/-	B1_DD+/-																								
GBEO_MD10-	A12	I/O Analog	3.3V max Suspend																						
GBEO_MD11+	A10	I/O Analog	3.3V max Suspend																						
GBEO_MD11-	A9	I/O Analog	3.3V max Suspend																						
GBEO_MD12+	A7	I/O Analog	3.3V max Suspend																						
GBEO_MD12-	A6	I/O Analog	3.3V max Suspend																						
GBEO_MD13+	A3	I/O Analog	3.3V max Suspend																						
GBEO_MD13-	A2	I/O Analog	3.3V max Suspend																						
GBEO_ACT#	B2	OD CMOS	3.3V Suspend/3.3V		Gigabit Ethernet Controller 0 activity indicator, active low.																				
GBEO_LINK#	A8	OD CMOS	3.3V Suspend/3.3V		Gigabit Ethernet Controller 0 link indicator, active low.																				
GBEO_LINK100#	A4	OD CMOS	3.3V Suspend/3.3V		Gigabit Ethernet Controller 0 100 Mbit / sec link indicator, active low.																				
GBEO_LINK1000#	A5	OD CMOS	3.3V Suspend/3.3V		Gigabit Ethernet Controller 0 1000 Mbit / sec link indicator, active low.																				
GBEO_CTREF	A14	REF	GND min 3.3V max	N.C.	Reference voltage for Carrier Board Ethernet channel 0 magnetics center tap. The reference voltage is determined by the requirements of the Module PHY and may be as low as 0V and as high as 3.3V. The reference voltage output shall be current limited on the Module. In the case in which the reference																				

IDE Signals Descriptions					
Signal	Pin#	Pin Type	Pwr Rail /Tolerance	PU/PD	Description
IDE_D0	D7	I/O CMOS	3.3V / 5V	PD 10K Ω to GND	Bidirectional data to / from IDE device.
IDE_D1	C10				
IDE_D2	C8				
IDE_D3	C4				
IDE_D4	D6				
IDE_D5	D2				
IDE_D6	C3				
IDE_D7	C2				
IDE_D8	C6				
IDE_D9	C7				
IDE_D10	D3				
IDE_D11	D4				
IDE_D12	D5				
IDE_D13	C9				
IDE_D14	C12				
IDE_D15	C5				
IDE_A0	D13	O CMOS	3.3V / 3.3V		Address lines to IDE device.
IDE_A1	D14				
IDE_A2	D15				
IDE_IOW#	D9	O CMOS	3.3V / 3.3V		I/O write line to IDE device. Data latched on trailing (rising) edge.
IDE_IOR#	C14	O CMOS	3.3V / 3.3V		I/O read line to IDE device.
IDE_REQ	D8	I CMOS	3.3V / 5V	PD 5.6K Ω to GND	IDE Device DMA Request. It is asserted by the IDE device to request a data transfer.
IDE_ACK#	D10	O CMOS	3.3V / 3.3V		IDE Device DMA Acknowledge.
IDE_CS1#	D16	O CMOS	3.3V / 3.3V		IDE Device Chip Select for 1F0h to 1FFh range.
IDE_CS3#	D17	O CMOS	3.3V / 3.3V		IDE Device Chip Select for 3F0h to 3FFh range.
IDE_IORDY	C13	I CMOS	3.3V / 5V	PU 4.7K Ω to 3.3V	IDE device I/O ready input. Pulled low by the IDE device to extend the cycle.
IDE_RESET#	D18	O CMOS	3.3V / 3.3V		Reset output to IDE device, active low.
IDE_IRQ	D12	I CMOS	3.3V / 5V	PD 10K Ω to GND	Interrupt request from IDE device.
IDE_CBLID#	D77	I CMOS	3.3V / 5V		Input from off-Module hardware indicating the type of IDE cable being used. High indicates a 40-pin cable used for legacy IDE modes. Low indicates that an 80-pin cable with interleaved grounds is used. Such a cable is required for Ultra-DMA 66, 100 and 133 modes.

SATA Signals Descriptions					
Signal	Pin#	Pin Type	Pwr Rail /Tolerance	PU/PD	Description
SATA0_TX+	A16	O SATA	AC coupled on Module		Serial ATA or SAS Channel 0 transmit differential pair.
SATA0_TX-	A17	O SATA	AC coupled on Module		
SATA0_RX+	A19	I SATA	AC coupled on Module		Serial ATA or SAS Channel 0 receive differential pair.
SATA0_RX-	A20	I SATA	AC coupled on Module		
SATA1_TX+	B16	O SATA	AC coupled on Module		Serial ATA or SAS Channel 1 transmit differential pair.
SATA1_TX-	B17	O SATA	AC coupled on Module		
SATA1_RX+	B19	I SATA	AC coupled on Module		Serial ATA or SAS Channel 1 receive differential pair.
SATA1_RX-	B20	I SATA	AC coupled on Module		
SATA2_TX+	A22	O SATA	AC coupled on Module		Serial ATA or SAS Channel 2 transmit differential pair.
SATA2_TX-	A23	O SATA	AC coupled on Module		
SATA2_RX+	A25	I SATA	AC coupled on Module		Serial ATA or SAS Channel 2 receive differential pair.
SATA2_RX-	A26	I SATA	AC coupled on Module		
SATA3_TX+	B22	O SATA	AC coupled on Module		Serial ATA or SAS Channel 3 transmit differential pair.
SATA3_TX-	B23	O SATA	AC coupled on Module		
SATA3_RX+	B25	I SATA	AC coupled on Module		Serial ATA or SAS Channel 3 receive differential pair.
SATA3_RX-	B26	I SATA	AC coupled on Module		
ATA_ACT#	A28	I/O CMOS	3.3V / 3.3V	PU 10K Ω to 3.3V	ATA (parallel and serial) or SAS activity indicator, active low.

PCI Express Lanes Signals Descriptions

Signal	Pin#	Pin Type	Pwr Rail /Tolerance	PU/PD	Description
PCIE_TX0+	A68	O PCIE	AC coupled on Module		PCI Express Differential Transmit Pairs 0
PCIE_TX0-	A69				
PCIE_RX0+	B68	I PCIE	AC coupled off Module		PCI Express Differential Receive Pairs 0
PCIE_RX0-	B69				
PCIE_TX1+	A64	O PCIE	AC coupled on Module		PCI Express Differential Transmit Pairs 1
PCIE_TX1-	A65				
PCIE_RX1+	B64	I PCIE	AC coupled off Module		PCI Express Differential Receive Pairs 1
PCIE_RX1-	B65				
PCIE_TX2+	A61	O PCIE	AC coupled on Module		PCI Express Differential Transmit Pairs 2
PCIE_TX2-	A62				
PCIE_RX2+	B61	I PCIE	AC coupled off Module		PCI Express Differential Receive Pairs 2
PCIE_RX2-	B62				
PCIE_TX3+	A58	O PCIE	AC coupled on Module		PCI Express Differential Transmit Pairs 3
PCIE_TX3-	A59				
PCIE_RX3+	B58	I PCIE	AC coupled off Module		PCI Express Differential Receive Pairs 3
PCIE_RX3-	B59				
PCIE_TX4+	A55	O PCIE	AC coupled on Module		PCI Express Differential Transmit Pairs 4
PCIE_TX4-	A56				
PCIE_RX4+	B55	I PCIE	AC coupled off Module		PCI Express Differential Receive Pairs 4
PCIE_RX4-	B56				
PCIE_TX5+	A52	O PCIE	AC coupled on Module		PCI Express Differential Transmit Pairs 5
PCIE_TX5-	A53				
PCIE_RX5+	B52	I PCIE	AC coupled off Module		PCI Express Differential Receive Pairs 5
PCIE_RX5-	B53				
PCIE0_CK_REF+	A88	O PCIE	PCIE		Reference clock output for all PCI Express and PCI Express Graphics lanes.
PCIE0_CK_REF-	A89				

PEG Signals Descriptions

Signal	Pin#	Pin Type	Pwr Rail /Tolerance	PU/PD	Description
PEG_TX0+	D52	O PCIE	AC coupled on Module		PCI Express Graphics transmit differential pairs 0
PEG_TX0-	D53				
PEG_RX0+	C52	I PCIE	AC coupled off Module		PCI Express Graphics receive differential pairs 0
PEG_RX0-	C53				
PEG_TX1+	D55	O PCIE	AC coupled on Module		PCI Express Graphics transmit differential pairs 1
PEG_TX1-	D56				
PEG_RX1+	C55	I PCIE	AC coupled off Module		PCI Express Graphics receive differential pairs 1
PEG_RX1-	C56				
PEG_TX2+	D58	O PCIE	AC coupled on Module		PCI Express Graphics transmit differential pairs 2
PEG_TX2-	D59				
PEG_RX2+	C58	I PCIE	AC coupled off Module		PCI Express Graphics receive differential pairs 2
PEG_RX2-	C59				
PEG_TX3+	D61	O PCIE	AC coupled on Module		PCI Express Graphics transmit differential pairs 3
PEG_TX3-	D62				
PEG_RX3+	C61	I PCIE	AC coupled off Module		PCI Express Graphics receive differential pairs 3
PEG_RX3-	C62				
PEG_TX4+	D65	O PCIE	AC coupled on Module		PCI Express Graphics transmit differential pairs 4
PEG_TX4-	D66				
PEG_RX4+	C65	I PCIE	AC coupled off Module		PCI Express Graphics receive differential pairs 4
PEG_RX4-	C66				
PEG_TX5+	D68	O PCIE	AC coupled on Module		PCI Express Graphics transmit differential pairs 5
PEG_TX5-	D69				
PEG_RX5+	C68	I PCIE	AC coupled off Module		PCI Express Graphics receive differential pairs 5
PEG_RX5-	C69				

PEG Signals Descriptions					
Signal	Pin#	Pin Type	Pwr Rail /Tolerance	PU/PD	Description
PEG_TX6+	D71				
PEG_TX6-	D72	O PCIE	AC coupled on Module		PCI Express Graphics transmit differential pairs 6
PEG_RX6+	C71	I PCIE	AC coupled off Module		PCI Express Graphics receive differential pairs 6
PEG_RX6-	C72				
PEG_TX7+	D74	O PCIE	AC coupled on Module		PCI Express Graphics transmit differential pairs 7
PEG_TX7-	D75				
PEG_RX7+	C74	I PCIE	AC coupled off Module		PCI Express Graphics receive differential pairs 7
PEG_RX7-	C75				
PEG_TX8+	D78	O PCIE	AC coupled on Module		PCI Express Graphics transmit differential pairs 8
PEG_TX8-	D79				
PEG_RX8+	C78	I PCIE	AC coupled off Module		PCI Express Graphics receive differential pairs 8
PEG_RX8-	C79				
PEG_TX9+	D81	O PCIE	AC coupled on Module		PCI Express Graphics transmit differential pairs 9
PEG_TX9-	D82				
PEG_RX9+	C81	I PCIE	AC coupled off Module		PCI Express Graphics receive differential pairs 9
PEG_RX9-	C82				
PEG_TX10+	D85	O PCIE	AC coupled on Module		PCI Express Graphics transmit differential pairs 10
PEG_TX10-	D86				
PEG_RX10+	C85	I PCIE	AC coupled off Module		PCI Express Graphics receive differential pairs 10
PEG_RX10-	C86				
PEG_TX11+	D88	O PCIE	AC coupled on Module		PCI Express Graphics transmit differential pairs 11
PEG_TX11-	D89				
PEG_RX11+	C88	I PCIE	AC coupled off Module		PCI Express Graphics receive differential pairs 11
PEG_RX11-	C89				
PEG_TX12+	D91	O PCIE	AC coupled on Module		PCI Express Graphics transmit differential pairs 12
PEG_TX12-	D92				
PEG_RX12+	C91	I PCIE	AC coupled off Module		PCI Express Graphics receive differential pairs 12
PEG_RX12-	C92				
PEG_TX13+	D94	O PCIE	AC coupled on Module		PCI Express Graphics transmit differential pairs 13
PEG_TX13-	D95				
PEG_RX13+	C94	I PCIE	AC coupled off Module		PCI Express Graphics receive differential pairs 13
PEG_RX13-	C95				
PEG_TX14+	D98	O PCIE	AC coupled on Module		PCI Express Graphics transmit differential pairs 14
PEG_TX14-	D99				
PEG_RX14+	C98	I PCIE	AC coupled off Module		PCI Express Graphics receive differential pairs 14
PEG_RX14-	C99				
PEG_TX15+	D101	O PCIE	AC coupled on Module		PCI Express Graphics transmit differential pairs 15
PEG_TX15-	D102				
PEG_RX15+	C101	I PCIE	AC coupled off Module		PCI Express Graphics receive differential pairs 15
PEG_RX15-	C102				
PEG_LANE_RV#	D54	I CMOS	3.3V / 3.3V		PCI Express Graphics lane reversal input strap. Pull low on the Carrier board to reverse lane order.
PEG_ENABLE#	D97	I CMOS	3.3V /3.3V	PU 10KΩ to 3.3V	Strap to enable PCI Express x16 external graphics interface. Pull low to enable the x16 PEG interface.

ExpressCard Signals Descriptions					
Signal	Pin#	Pin Type	Pwr Rail /Tolerance	PU/PD	Description
EXCDO_CPPE#	A49	I CMOS	3.3V /3.3V	PU 10KΩ to 3.3V	PCI ExpressCard: PCI Express capable card request, active low, one per card
EXCD1_CPPE#	B48				
EXCDO_PERST#	A48	O CMOS	3.3V /3.3V		PCI ExpressCard: reset, active low, one per card
EXCD1_PERST#	B47				

PCI Signals Descriptions					
Signal	Pin#	Pin Type	Pwr Rail /Tolerance	PU/PD	Description
PCI_AD0	C24				
PCI_AD1	D22				
PCI_AD2	C25				
PCI_AD3	D23				
PCI_AD4	C26				
PCI_AD5	D24				
PCI_AD6	C27				
PCI_AD7	D25				
PCI_AD8	C28				
PCI_AD9	D27				
PCI_AD10	C29				
PCI_AD11	D28				
PCI_AD12	C30				
PCI_AD13	D29				
PCI_AD14	C32				
PCI_AD15	D30	I/O CMOS	3.3V / 5V		PCI bus multiplexed address and data lines
PCI_AD16	D37				
PCI_AD17	C39				
PCI_AD18	D38				
PCI_AD19	C40				
PCI_AD20	D39				
PCI_AD21	C42				
PCI_AD22	D40				
PCI_AD23	C43				
PCI_AD24	D42				
PCI_AD25	C45				
PCI_AD26	D43				
PCI_AD27	C46				
PCI_AD28	D44				
PCI_AD29	C47				
PCI_AD30	D45				
PCI_AD31	C48				
PCI_C/BE0#	D26				
PCI_C/BE1#	C33	I/O CMOS	3.3V / 5V		PCI bus byte enable lines, active low
PCI_C/BE2#	C38				
PCI_C/BE3#	C44				
PCI_DEVSEL#	C36	I/O CMOS	3.3V / 5V	PU 8.2K Ω to 3.3V	PCI bus Device Select, active low.
PCI_FRAME#	D36	I/O CMOS	3.3V / 5V	PU 8.2K Ω to 3.3V	PCI bus Frame control line, active low.
PCI_IRDY#	C37	I/O CMOS	3.3V / 5V	PU 8.2K Ω to 3.3V	PCI bus Initiator Ready control line, active low.
PCI_TRDY#	D35	I/O CMOS	3.3V / 5V	PU 8.2K Ω to 3.3V	PCI bus Target Ready control line, active low.
PCI_STOP#	D34	I/O CMOS	3.3V / 5V	PU 8.2K Ω to 3.3V	PCI bus STOP control line, active low, driven by cycle initiator.
PCI_PAR	D32	I/O CMOS	3.3V / 5V		PCI bus parity
PCI_PERR#	C34	I/O CMOS	3.3V / 5V	PU 8.2K Ω to 3.3V	Parity Error: An external PCI device drives PERR# when it receives data that has a parity error.
PCI_REQ0#	C22			PU 8.2K Ω to 3.3V	
PCI_REQ1#	C19	I CMOS	3.3V / 5V	PU 8.2K Ω to 3.3V	PCI bus master request input lines, active low.
PCI_REQ2#	C17			PU 8.2K Ω to 3.3V	
PCI_REQ3#	D20			PU 8.2K Ω to 3.3V	
PCI_GNT0#	C20				
PCI_GNT1#	C18	O CMOS	3.3V / 5V		PCI bus master grant output lines, active low.
PCI_GNT2#	C16				
PCI_GNT3#	D19				

PCI Signals Descriptions					
Signal	Pin#	Pin Type	Pwr Rail /Tolerance	PU/PD	Description
PCI_RESET#	C23	O CMOS	3.3V Suspend/ 5V		PCI Reset output, active low.
PCI_LOCK#	C35	I/O CMOS	3.3V / 5V	PU 8.2K Ω to 3.3V	PCI Lock control line, active low.
PCI_SERR#	D33	I/O OD CMOS	3.3V / 5V	PU 8.2K Ω to 3.3V	System Error: SERR# may be pulsed active by any PCI device that detects a system error condition.
PCI_PME#	C15	I CMOS	3.3V Suspend/ 5V	PU 10K Ω to 3.3V Suspend	PCI Power Management Event: PCI peripherals drive PME# to wake system from low-power states S1–S5.
PCI_CLKRUN#	D48	I/O CMOS	3.3V / 5V	PU 8.2K Ω to 3.3V	Bidirectional pin used to support PCI clock run protocol for mobile systems.
PCI_IRQA#	C49	I CMOS	3.3V / 5V	PU 8.2K Ω to 3.3V	PCI interrupt request lines.
PCI_IROB#	C50			PU 8.2K Ω to 3.3V	
PCI_IRQC#	D46			PU 8.2K Ω to 3.3V	
PCI_IRQD#	D47			PU 8.2K Ω to 3.3V	
PCI_CLK	D50	O CMOS	3.3V / 3.3V		PCI 33MHz clock output.
PCI_M66EN	D49	I CMOS	3.3V / 5V	N.C. and chip PD 10K Ω to GND	Module input signal indicates whether an off-Module PCI device is capable of 66MHz operation. Pulled to GND by Carrier Board device or by Slot Card if the devices are NOT capable of 66 MHz operation. If the Module is not capable of supporting 66 MHz PCI operation, this input may be a no-connect on the Module. If the Module is capable of supporting 66 MHz PCI operation, and if this input is held low by the Carrier Board, the Module PCI interface shall operate at 33 MHz.

USB Signals Descriptions					
Signal	Pin#	Pin Type	Pwr Rail /Tolerance	PU/PD	Description
USB0+	A46	I/O USB	3.3V Suspend/3.3V		USB differential pairs 0
USB0-	A45				
USB1+	B46	I/O USB	3.3V Suspend/3.3V		USB differential pairs 1
USB1-	B45				
USB2+	A43	I/O USB	3.3V Suspend/3.3V		USB differential pairs 2
USB2-	A42				
USB3+	B43	I/O USB	3.3V Suspend/3.3V		USB differential pairs 3
USB3-	B42				
USB4+	A40	I/O USB	3.3V Suspend/3.3V		USB differential pairs 4
USB4-	A39				
USB5+	B40	I/O USB	3.3V Suspend/3.3V		USB differential pairs 5
USB5-	B39				
USB6+	A37	I/O USB	3.3V Suspend/3.3V		USB differential pairs 6
USB6-	A36				
USB7+	B37	I/O USB	3.3V Suspend/3.3V		USB differential pairs 7, USB7 may be configured as a USB client or as a host, or both, at the Module designer's discretion. (CR902-B/BL default set as a host)
USB7-	B36				
USB_0_1_OC#	B44	I CMOS	3.3V Suspend/3.3V	PU 10K Ω to 3.3V Suspend	USB over-current sense, USB channels 0 and 1. A pull-up for this line shall be present on the Module. An open drain driver from a USB current monitor on the Carrier Board may drive this line low. Do not pull this line high on the Carrier Board.
USB_2_3_OC#	A44	I CMOS	3.3V Suspend/3.3V	PU 10K Ω to 3.3V Suspend	USB over-current sense, USB channels 2 and 3. A pull-up for this line shall be present on the Module. An open drain driver from a USB current monitor on the Carrier Board may drive this line low. Do not pull this line high on the Carrier Board.
USB_4_5_OC#	B38	I CMOS	3.3V Suspend/3.3V	PU 10K Ω to 3.3V Suspend	USB over-current sense, USB channels 4 and 5. A pull-up for this line shall be present on the Module. An open drain driver from a USB current monitor on the Carrier Board may drive this line low. Do not pull this line high on the Carrier Board.
USB_6_7_OC#	A38	I CMOS	3.3V Suspend/3.3V	PU 10K Ω to 3.3V Suspend	USB over-current sense, USB channels 6 and 7. A pull-up for this line shall be present on the Module. An open drain driver from a USB current monitor on the Carrier Board may drive this line low. Do not pull this line high on the Carrier Board.

LVDS Signals Descriptions					
Signal	Pin#	Pin Type	Pwr Rail /Tolerance	PU/PD	Description
LVDS_A0+	A71	O LVDS	LVDS		LVDS Channel A differential pairs
LVDS_A0-	A72				
LVDS_A1+	A73				
LVDS_A1-	A74				
LVDS_A2+	A75				
LVDS_A2-	A76				
LVDS_A3+	A78	O LVDS	LVDS		LVDS Channel A differential clock
LVDS_A3-	A79				
LVDS_A_CK+	A81	O LVDS	LVDS		LVDS Channel A differential clock
LVDS_A_CK-	A82				
LVDS_B0+	B71	O LVDS	LVDS		LVDS Channel B differential pairs
LVDS_B0-	B72				
LVDS_B1+	B73				
LVDS_B1-	B74				
LVDS_B2+	B75				
LVDS_B2-	B76				
LVDS_B3+	B77	O LVDS	LVDS		LVDS Channel B differential clock
LVDS_B3-	B78				
LVDS_B_CK+	B81	O LVDS	LVDS		LVDS Channel B differential clock
LVDS_B_CK-	B82				
LVDS_VDD_EN	A77	O CMOS	3.3V / 3.3V	PD 100KΩ to GND	LVDS panel power enable
LVDS_BKLT_EN	B79	O CMOS	3.3V / 3.3V	PD 100KΩ to GND	LVDS panel backlight enable
LVDS_BKLT_CTRL	B83	O CMOS	3.3V / 3.3V	PD 100KΩ to GND	LVDS panel backlight brightness control
LVDS_I2C_CK	A83	I/O OD CMOS	3.3V / 3.3V	PU 2.2KΩ to 3.3V	I2C clock output for LVDS display use
LVDS_I2C_DAT	A84	I/O OD CMOS	3.3V / 3.3V	PU 2.2KΩ to 3.3V	I2C data line for LVDS display use

LPC Signals Descriptions					
Signal	Pin#	Pin Type	Pwr Rail /Tolerance	PU/PD	Description
LPC_AD0	B4	I/O CMOS	3.3V / 3.3V		LPC multiplexed address, command and data bus
LPC_AD1	B5				
LPC_AD2	B6				
LPC_AD3	B7				
LPC_FRAME#	B3	O CMOS	3.3V / 3.3V		LPC frame indicates the start of an LPC cycle
LPC_DRQ0#	B8	I CMOS	3.3V / 3.3V		LPC serial DMA request
LPC_DRQ1#	B9				
LPC_SERIRQ	A50	I/O CMOS	3.3V / 3.3V	PU 10KΩ to 3.3V	LPC serial interrupt
LPC_CLK	B10	O CMOS	3.3V / 3.3V		LPC clock output - 33MHz nominal

SPI Signals Descriptions					
Signal	Pin#	Pin Type	Pwr Rail /Tolerance	PU/PD	Description
SPI_CS#	B97	O CMOS	3.3V Suspend/3.3V		Chip select for Carrier Board SPI - may be sourced from chipset SPI0 or SPI1
SPI_MISO	A92	I CMOS	3.3V Suspend/3.3V		Data in to Module from Carrier SPI
SPI_MOSI	A95	O CMOS	3.3V Suspend/3.3V		Data out from Module to Carrier SPI
SPI_CLK	A94	O CMOS	3.3V Suspend/3.3V		Clock from Module to Carrier SPI
SPI_POWER	A91	O	3.3V Suspend/3.3V		Power supply for Carrier Board SPI – sourced from Module – nominally 3.3V. The Module shall provide a minimum of 100mA on SPI_POWER. Carriers shall use less than 100mA of SPI_POWER. SPI_POWER shall only be used to power SPI devices on the Carrier
BIOS_DIS0#	A34	I CMOS	NA		Selection straps to determine the BIOS boot device. The Carrier should only float these or pull them low, please refer to COM Express Module Base Specification Revision 2.1 for strapping options of BIOS disable signals.
BIOS_DIS1#	B88				

VGA Signals Descriptions

Signal	Pin#	Pin Type	Pwr Rail /Tolerance	PU/PD	Description
VGA_RED	B89	O Analog	Analog	PD 150Ω	Red for monitor. Analog output
VGA_GRN	B91	O Analog	Analog	PD 150Ω	Green for monitor. Analog output
VGA_BLU	B92	O Analog	Analog	PD 150Ω	Blue for monitor. Analog output
VGA_HSYNC	B93	O CMOS	3.3V / 3.3V		Horizontal sync output to VGA monitor
VGA_VSYNC	B94	O CMOS	3.3V / 3.3V		Vertical sync output to VGA monitor
VGA_I2C_CK	B95	I/O OD CMOS	3.3V / 3.3V	PU 2.2KΩ to 3.3V	DDC clock line (I2C port dedicated to identify VGA monitor capabilities)
VGA_I2C_DAT	B96	I/O OD CMOS	3.3V / 3.3V	PU 2.2KΩ to 3.3V	DDC data line.

I2C BUS Signal Descriptions

Signal	Pin#	Pin Type	Pwr Rail /Tolerance	PU/PD	Description
I2C_CK	B33	I/O OD CMOS	3.3V Suspend/3.3V	PU 2.2KΩ to 3.3V Suspend	General purpose I2C port clock output
I2C_DAT	B34	I/O OD CMOS	3.3V Suspend/3.3V	PU 2.2KΩ to 3.3V Suspend	General purpose I2C port data I/O line

Miscellaneous Signal Descriptions

Signal	Pin#	Pin Type	Pwr Rail /Tolerance	PU/PD	Description
SPKR	B32	O CMOS	3.3V / 3.3V		Output for audio enunciator - the "speaker" in PC-AT systems. This port provides the PC beep signal and is mostly intended for debugging purposes.
WDT	B27	O CMOS	3.3V / 3.3V		Output indicating that a watchdog time-out event has occurred.
KBD_RST#	A86	I CMOS	3.3V / 3.3V	PU 10KΩ to 3.3V	Input to Module from (optional) external keyboard controller that can force a reset. Pulled high on the Module. This is a legacy artifact of the PC-AT.
KBD_A20GATE	A87	I CMOS	3.3V / 3.3V	PU 10KΩ to 3.3V	Input to Module from (optional) external keyboard controller that can be used to control the CPU A20 gate line. The A20GATE restricts the memory access to the bottom megabyte and is a legacy artifact of the PC-AT. Pulled high on the Module.

Power and System Management Signals Descriptions					
Signal	Pin#	Pin Type	Pwr Rail /Tolerance	PU/PD	Description
PWRBTN#	B12	I CMOS	3.3V Suspend/3.3V	PU 10KΩ to 3.3V Suspend	A falling edge creates a power button event. Power button events can be used to bring a system out of S5 soft off and other suspend states, as well as powering the system down.
SYS_RESET#	B49	I CMOS	3.3V Suspend/3.3V	PU 10KΩ to 3.3V Suspend	Reset button input. Active low request for Module to reset and reboot. May be falling edge sensitive. For situations when SYS_RESET# is not able to reestablish control of the system, PWR_OK or a power cycle may be used.
CB_RESET#	B50	O CMOS	3.3V Suspend/3.3V	PD 100KΩ to GND	Reset output from Module to Carrier Board. Active low. Issued by Module chipset and may result from a low SYS_RESET# input, a low PWR_OK input, a VCC_12V power input that falls below the minimum specification, a watchdog timeout, or may be initiated by the Module software.
PWR_OK	B24	I CMOS	3.3V / 3.3V		Power OK from main power supply. A high value indicates that the power is good. This signal can be used to hold off Module startup to allow Carrier based FPGAs or other configurable devices time to be programmed.
SUS_STAT#	B18	O CMOS	3.3V Suspend/3.3V		Indicates imminent suspend operation; used to notify LPC devices.
SUS_S3#	A15	O CMOS	3.3V Suspend/3.3V		Indicates system is in Suspend to RAM state. Active low output. An inverted copy of SUS_S3# on the Carrier Board may be used to enable the non-standby power on a typical ATX supply.
SUS_S4#	A18	O CMOS	3.3V Suspend/3.3V		Indicates system is in Suspend to Disk state. Active low output.
SUS_S5#	A24	O CMOS	3.3V Suspend/3.3V		Indicates system is in Soft Off state.
WAKEO#	B66	I CMOS	3.3V Suspend/3.3V	PU 10KΩ to 3.3V Suspend	PCI Express wake up signal.
WAKE1#	B67	I CMOS	3.3V Suspend/3.3V	PU 10KΩ to 3.3V Suspend	General purpose wake up signal. May be used to implement wake-up on PS2 keyboard or mouse activity.
BATLOW#	A27	I CMOS	3.3V Suspend/ 3.3V	PU 10KΩ to 3.3V Suspend	Indicates that external battery is low. This port provides a battery-low signal to the Module for orderly transitioning to power saving or power cut-off ACPI modes.

Thermal Protection Signals Descriptions					
Signal	Pin#	Pin Type	Pwr Rail /Tolerance	PU/PD	Description
THRM#	B35	I CMOS	3.3V / 3.3V	PU 10KΩ to 3.3V	Input from off-Module temp sensor indicating an over-temp situation.
THRMTRIP#	A35	O CMOS	3.3V / 3.3V	PU 10KΩ to 3.3V	Active low output indicating that the CPU has entered thermal shutdown.

SM Bus Signals Descriptions					
Signal	Pin#	Pin Type	Pwr Rail /Tolerance	PU/PD	Description
SMB_CK	B13	I/O OD CMOS	3.3V Suspend/3.3V	PU 2.2KΩ to 3.3VSB	System Management Bus bidirectional clock line.
SMB_DAT	B14	I/O OD CMOS	3.3V Suspend/3.3V	PU 2.2KΩ to 3.3VSB	System Management Bus bidirectional data line.
SMB_ALERT#	B15	I CMOS	3.3V Suspend/3.3V	PU 10KΩ to 3.3VSB	System Management Bus Alert – active low input can be used to generate an SMI# (System Management Interrupt) or to wake the system.

GPIO Signals Descriptions					
Signal	Pin#	Pin Type	Pwr Rail /Tolerance	PU/PD	Description
GPO0	A93	O CMOS	3.3V / 3.3V		General purpose output pins.
GPO1	B54				
GPO2	B57				
GPO3	B63				
GPI0	A54	I CMOS	3.3V Suspend / 3.3V		General purpose input pins. (Note: Default input)
GPI1	A63				
GPI2	A67				
GPI3	A85				

Power and GND Signal Descriptions					
Signal	Pin#	Pin Type	Pwr Rail /Tolerance	PU/PD	Description
VCC_12V	A104-A109 B104-B109 C104-C109 D104-D109	Power			Primary power input: +12V nominal. All available VCC_12V pins on the connector(s) shall be used.
VCC_5V_SBY	B84-B87	Power			Standby power input: +5.0V nominal. If VCC5_SBY is used, all available VCC_5V_SBY pins on the connector(s) shall be used. Only used for standby and suspend functions. May be left unconnected if these functions are not used in the system design.
VCC_RTC	A47	Power			Real-time clock circuit-power input. Nominally +3.0V.
GND	A1, A11, A21, A31, A41, A51, A57, A60, A66, A70, A80, A90, A96, A100, A110, B1, B11, B21, B31, B41, B51, B60, B70, B80, B90, B100, B110, C1, C11, C21, C31, C41, C51, C60, C70, C76, C80, C84, C87, C90, C93, C96, C100, C103, C110, D1, D11, D21, D31, D41, D51, D60, D67, D70, D76, D80, D84, D87, D90, D93, D96, D100, D103, D110	Power			Ground - DC power and signal and AC signal return path. All available GND connector pins shall be used and tied to Carrier Board GND plane.

Module type Signal Descriptions					
Signal	Pin#	Pin Type	Pwr Rail /Tolerance	PU/PD	Description
TYPE0#	C54	PDS		N.C.	TYPE2# TYPE1# TYPE0# X X X pin out Type 1 NC NC NC pin out Type 2 NC NC GND pin out Type 3 (no IDE) NC GND NC pin out Type 4 (no PCI) NC GND GND pin out Type 5 (no IDE, no PCI) GND NC NC pin out Type 6 (no IDE, no PCI)
TYPE1#	C57	PDS		N.C.	
TYPE2#	D57	PDS		N.C.	
TYPE10#	A97	PDS		N.C.	TYPE 10# NC pin out R2.0 PD pin out Type 10 pull down to ground with 47K resistor 12V pin out R1.0 A carrier can detect a R1.0 Module by the presence of 12V on this pin. R2.0 Module types 1-6 will not connect this pin. Type 10 Modules shall pull this pin to ground through a 4.7K resistor.

Standby Power LED

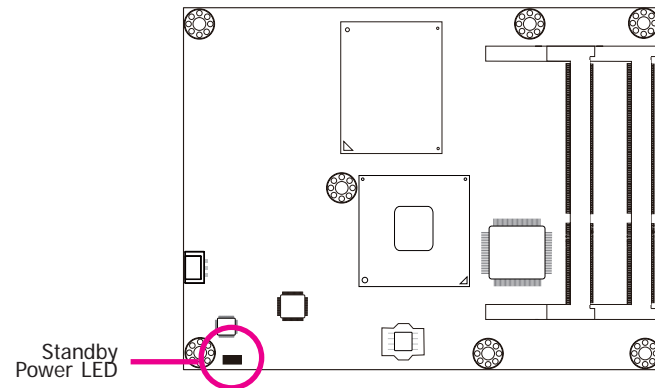

This LED will light when the system is in the standby mode.

Cooling Option

Heat Spreader/Heat Spreader with Heat Sink and Fan



Note:

The system board used in the following illustrations may not resemble the actual board. These illustrations are for reference only.



Top View of the Heat Sink

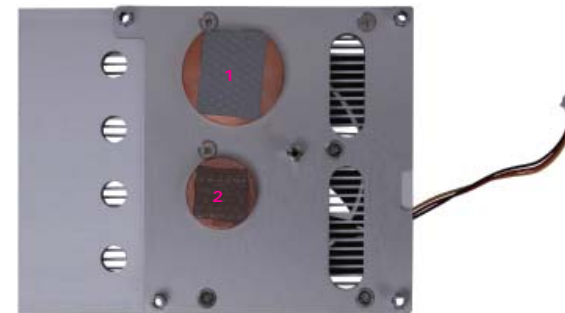

Bottom View of the Heat Sink

- "1" and "2" denote the locations of the thermal pads designed to contact the corresponding components that are on CR902-B/BL Series.



Important:

Remove the plastic covering from the thermal pads prior to mounting the heat sink onto CR902-B/BL Series.

Installing CR902-B/BL Series onto a Carrier Board



Important:

The carrier board (COM330-B) used in this section is for reference purpose only and may not resemble your carrier board. These illustrations are mainly to guide you on how to install CR902-B/BL Series onto the carrier board of your choice. The system board used in the following illustrations may not resemble the actual one. These illustrations are for reference only.

• To download COM330-B datasheet and manual

1. Use the provided screw to install the heatsink onto the module. First align the mounting hole of the heatsink with the mounting hole of the module and then from the bottom side of the module, secure them with the provided screw. The module and heatsink assembly should look like the one shown below.

bottom side of heat sink

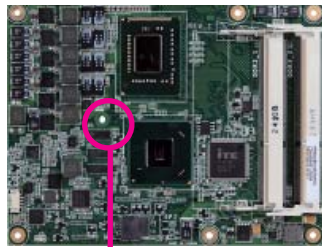

Mounting hole

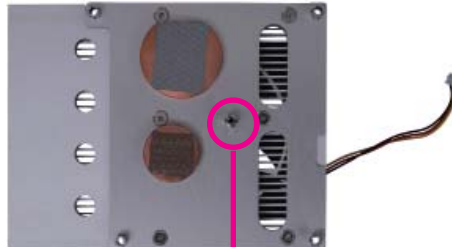

Mounting hole



Top view



Bottom view



Mounting screw

2. Now install the module and heatsink assembly onto the carrier board. The photo below shows the locations of the mounting holes on carrier board.

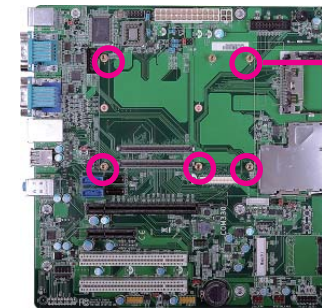

Mounting hole

3. Insert the provided mounting screws into the mounting holes - from the bottom through the top of the carrier board.

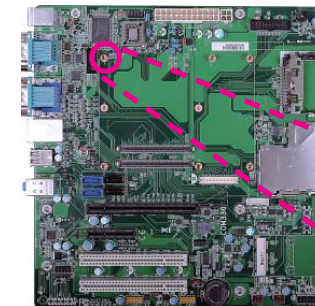

Mounting screws



4. While supporting the mounting screw at the bottom, from the top side of the board, fasten a bolt into the screw.

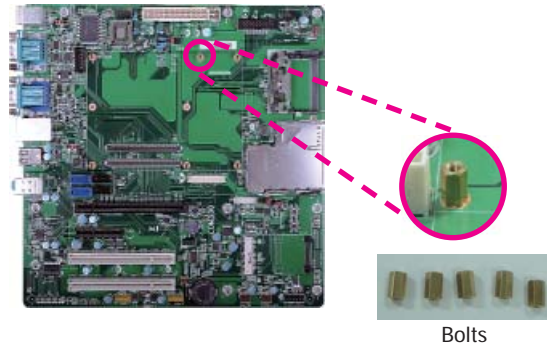

5. The photo below shows the solder side of the board with the screws already fixed in place.

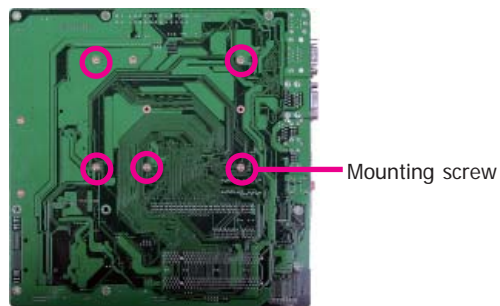

6. The photo below shows the component side of the board with the bolts already fixed in place.

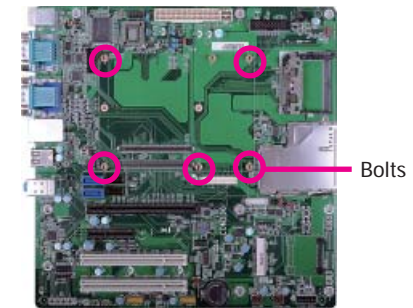

7. Position the heat sink on top of CR902-B/BL series with the heat sink's mounting holes aligned with CR902-B/BL's mounting holes. Insert one of the provided long screws into the mounting hole shown in the photo below.

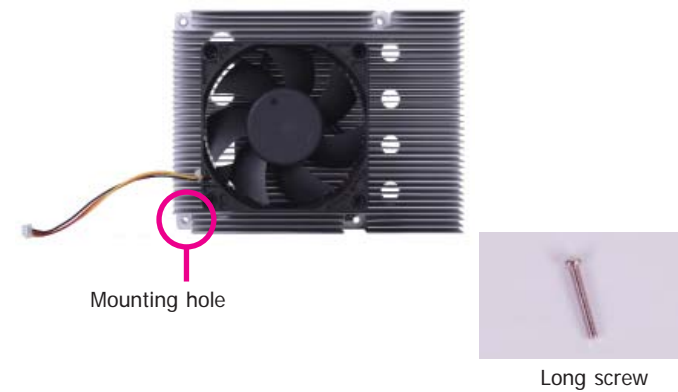

- From the bottom of the board, fasten the provided bolt into the screw and then connect the heat spreader/heat spreader with heat sink and fan's cable to the fan connector on CR902-B/BL Series.

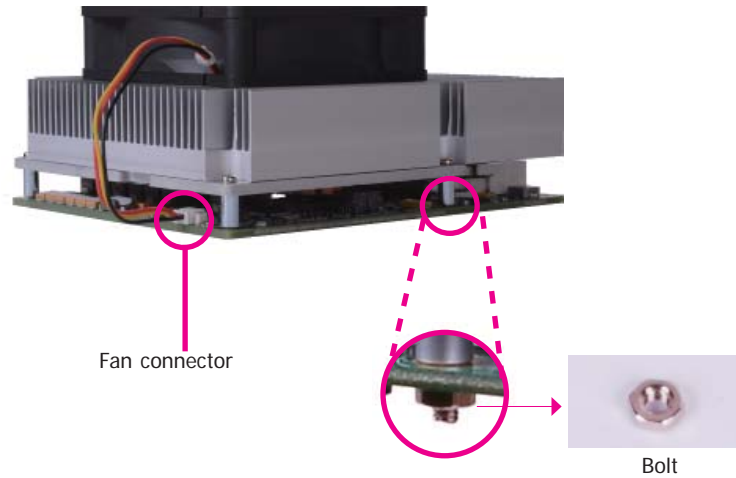

- Grasping CR902-B/BL Series by its edges, position it on top of the carrier board with its mounting holes aligned with the bolts on the carrier board. This will also align the COM Express connectors of the two boards to each other.

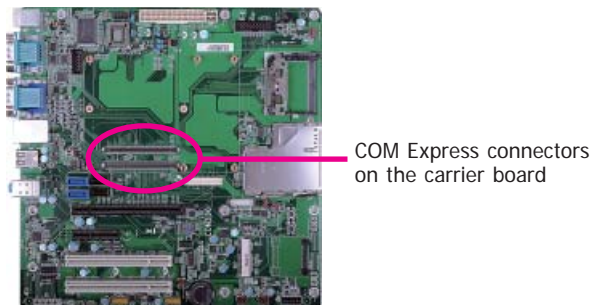
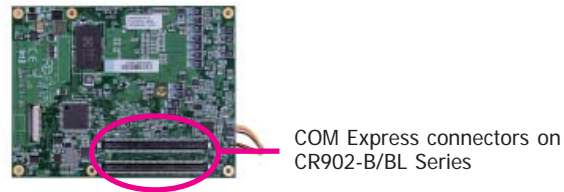

- Press CR902-B/BL Series down firmly until it is completely seated on the COM Express connectors of the carrier board.

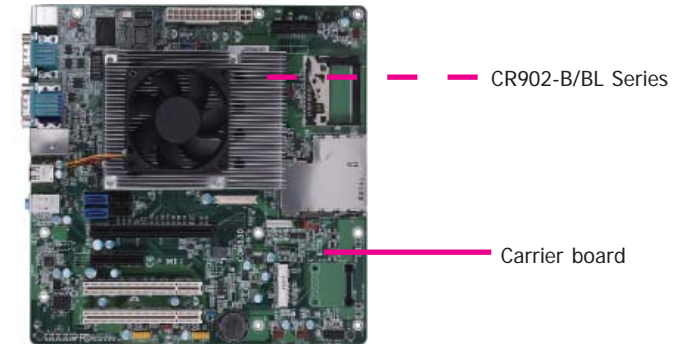

- Use the provided mounting screws to secure CR902-B/BL Series with heat sink to the carrier board. The photo below shows the locations of the long/short mounting screws.

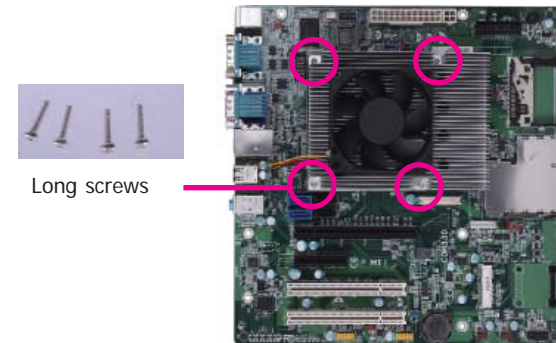

Chapter 4 - BIOS Setup

Overview

The BIOS is a program that takes care of the basic level of communication between the CPU and peripherals. It contains codes for various advanced features found in this system board. The BIOS allows you to configure the system and save the configuration in a battery-backed CMOS so that the data retains even when the power is off. In general, the information stored in the CMOS RAM of the EEPROM will stay unchanged unless a configuration change has been made such as a hard drive replaced or a device added. It is possible that the CMOS battery will fail causing CMOS data loss. If this happens, you need to install a new CMOS battery and reconfigure the BIOS settings.

Note:

The BIOS is constantly updated to improve the performance of the system board; therefore the BIOS screens in this chapter may not appear the same as the actual one. These screens are for reference purpose only.

Default Configuration

Most of the configuration settings are either predefined according to the Load Optimal Defaults settings which are stored in the BIOS or are automatically detected and configured without requiring any actions. There are a few settings that you may need to change depending on your system configuration.

Entering the BIOS Setup Utility

The BIOS Setup Utility can only be operated from the keyboard and all commands are keyboard commands. The commands are available at the right side of each setup screen.

The BIOS Setup Utility does not require an operating system to run. After you power up the system, the BIOS message appears on the screen and the memory count begins. After the memory test, the message "Press DEL to run setup" will appear on the screen. If the message disappears before you respond, restart the system or press the "Reset" button. You may also restart the system by pressing the <Ctrl> <Alt> and keys simultaneously.

Legends

KEYs	Function
Right and Left Arrows	Moves the highlight left or right to select a menu.
Up and Down Arrows	Moves the highlight up or down between submenus or fields.
<Esc>	Exits to the BIOS setup utility
+ (plus key)	Scrolls forward through the values or options of the highlighted field.
- (minus key)	Scrolls backward through the values or options of the highlighted field.
<F1>	Displays general help
<F2>	Displays previous values
<F3>	Optimized defaults
<F4>	Saves and reset the setup program.
<Enter>	Press <Enter> to enter the highlighted submenu

Scroll Bar

When a scroll bar appears to the right of the setup screen, it indicates that there are more available fields not shown on the screen. Use the up and down arrow keys to scroll through all the available fields.

Submenu

When "►" appears on the left of a particular field, it indicates that a submenu which contains additional options are available for that field. To display the submenu, move the highlight to that field and press <Enter>.

AMI BIOS Setup Utility

Main

The Main menu is the first screen that you will see when you enter the BIOS Setup Utility.

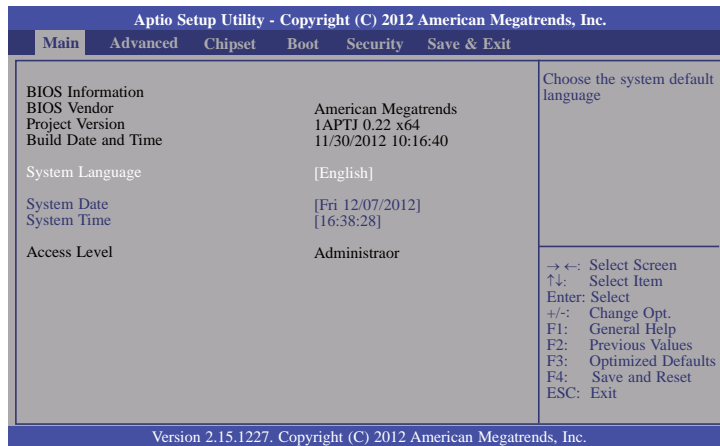

System Date

The date format is <day>, <month>, <date>, <year>. Day displays a day, from Sunday to Saturday. Month displays the month, from January to December. Date displays the date, from 1 to 31. Year displays the year, from 1980 to 2099.

System Time

The time format is <hour>, <minute>, <second>. The time is based on the 24-hour military-time clock. For example, 1 p.m. is 13:00:00. Hour displays hours from 00 to 23. Minute displays minutes from 00 to 59. Second displays seconds from 00 to 59.

Advanced

The Advanced menu allows you to configure your system for basic operation. Some entries are defaults required by the system board, while others, if enabled, will improve the performance of your system or let you set some features according to your preference.



Important:

Setting incorrect field values may cause the system to malfunction.

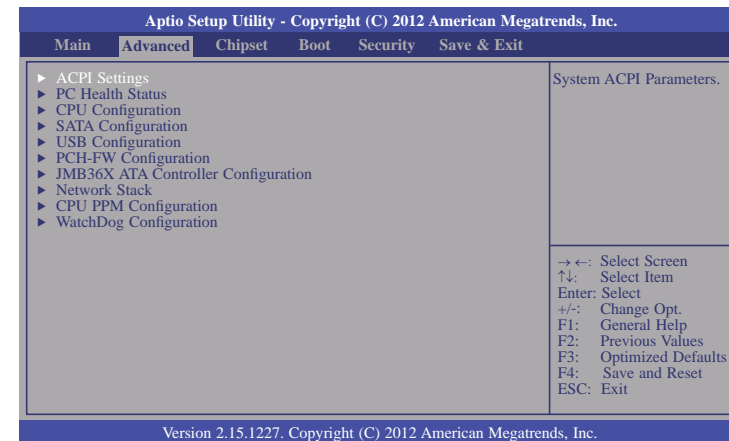

ACPI Power Management Configuration

This section is used to configure the ACPI Power Management.

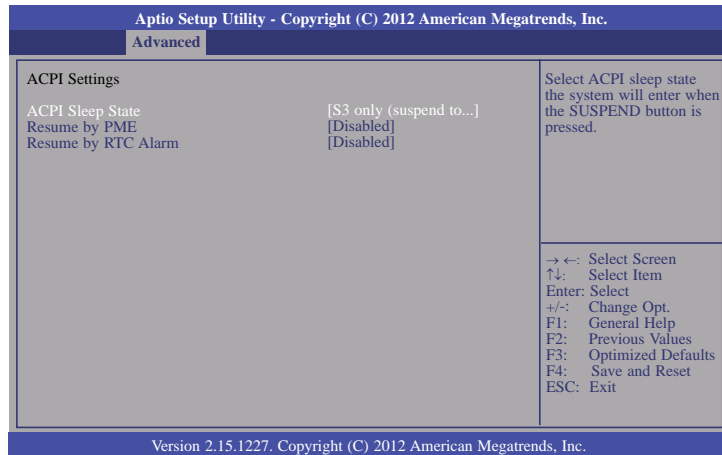

ACPI Sleep State

Selects the highest ACPI sleep state the system will enter when the Suspend button is pressed.

S1(POS) Enables the Power On Suspend function.

S3(STR) Enables the Suspend to RAM function.

Resume by PME

Enable this field to use the PME signal to wake up the system (via PCIE and onboard LAN).

Resume by RTC Alarm

When Enabled, the system uses the RTC to generate a wakeup event.

PC Health Status

This section displays hardware health monitor.

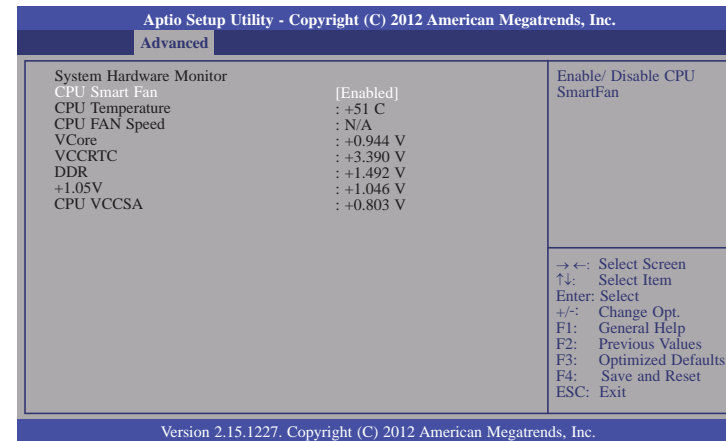

CPU Configuration

This section is used to configure the CPU. It will also display the detected CPU information.

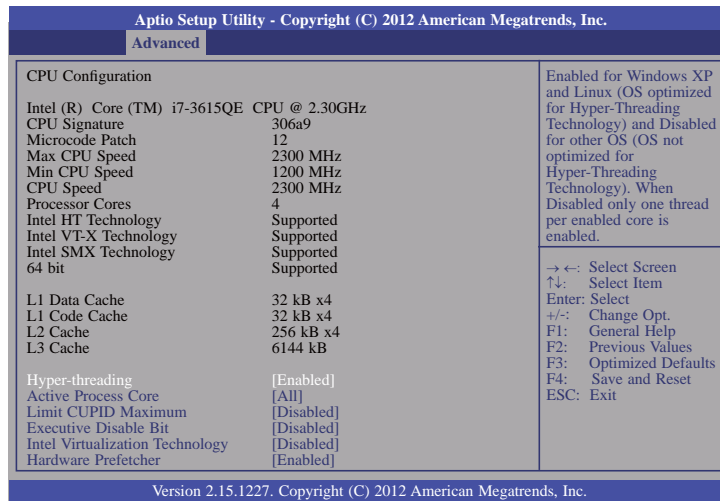

Hyper-threading

Enable this field for Windows XP and Linux which are optimized for Hyper-Threading technology. Select disabled for other OSES not optimized for Hyper-Threading technology. When disabled, only one thread per enabled core is enabled.

Active Process Core

Number of cores to enable in each processor package

Limit CUPID Maximum

The CUPID instruction of some newer CPUs will return a value greater than 3. The default is Disabled because this problem does not exist in the Windows series operating systems. If you are using an operating system other than Windows, this problem may occur. To avoid this problem, enable this field to limit the return value to 3 or less than 3.

Executive Disable Bit

XD can prevent certain classes of malicious buffer overflow attacks when combined with a supporting OS (Windows Server 2003 SP1, Windows XP SP2, SuSE Linux 9.2, RedHat Enterprise 3 Update 3.)

Intel Virtualization Technology

When this field is set to Enabled, the VMM can utilize the additional hardware capabilities provided by Vanderpool Technology.

Hardware Prefetcher

To turn on/off the Mid level Cache (L2) streamer prefetcher.

SATA Configuration

This section is used to configure SATA functions.

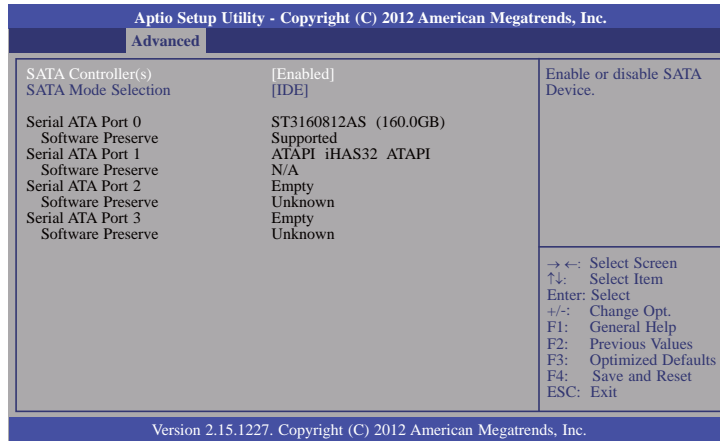

SATA Controller(s)

This field is used to enable or disable the Serial ATA channels.

SATA Mode Selection

IDE Mode

This option configures the Serial ATA drives as Parallel ATA storage devices.

AHCI Mode

This option allows the Serial ATA devices to use AHCI (Advanced Host Controller Interface).

RAID Mode (CR902-B Series only)

This option allows the Serial ATA devices to use RAID 0/1/5/10/Recovery (Redundant Array of Independent Disks)

If AHCI or RAID(CR902-B only) is selected in the SATA Mode Selection, it will display the following information:

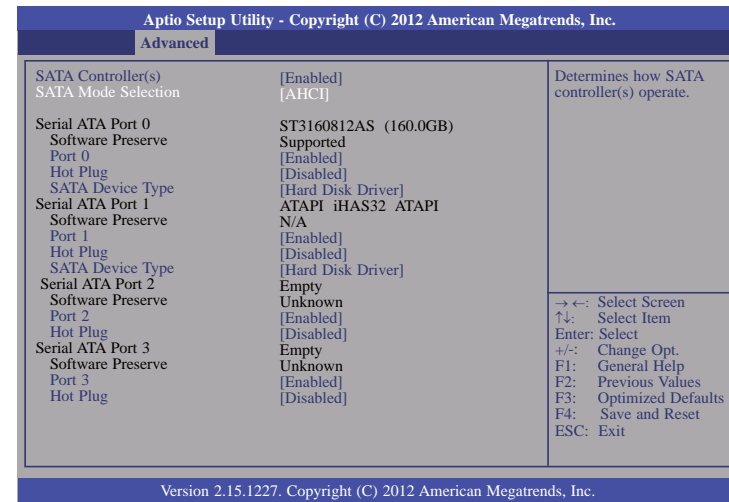

Serial ATA Port 0 to Serial ATA Port 3

These fields are used to configure the connected SATA devices.

USB Configuration

This section is used to configure USB.

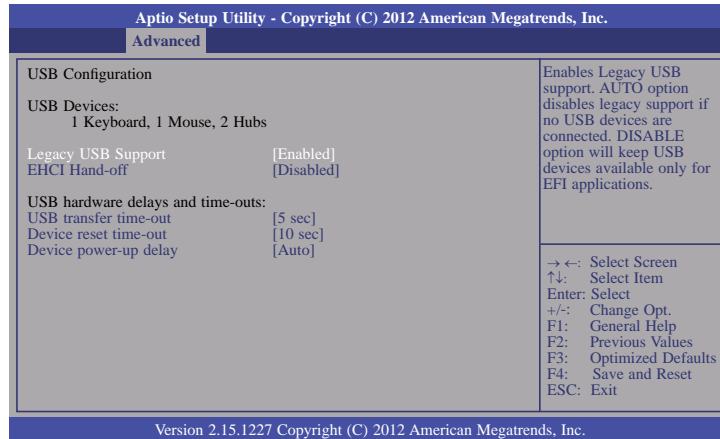

Legacy USB Support

Enabled

Enables legacy USB.

Auto

Disables support for legacy when no USB devices are connected.

Disabled

Keeps USB devices available only for EFI applications.

EHCI Hand-off

This is a workaround for OSes that does not support EHCI hand-off. The EHCI ownership change should be claimed by the EHCI driver.

USB transfer time-out

The time-out value for Bulk and Interrupt transfers.

Device reset time-out

Selects the USB mass storage device start unit command timeout.

Device power-up delay

Maximum time the device will take before it properly reports itself to the Host Controller. "Auto" uses default value: for a Root port it is 100 ms, for a Hub port the delay is taken from Hub descriptor.

PCH-FW Configuration

Aptio Setup Utility - Copyright (C) 2012 American Megatrends, Inc.	
Advanced	
ME FW Version	8,0.13.1502
ME Firmware Mode	Normal Mode
ME Firmware Type	Full Sku Firmware
ME Firmware SKU	5MB
→ ←: Select Screen ↑ ↓: Select Item Enter: Select +/-: Change Opt. F1: General Help F2: Previous Values F3: Optimized Defaults F4: Save and Reset ESC: Exit	
Version 2.15.1227. Copyright (C) 2012 American Megatrends, Inc.	

JMB36X ATA Controller Configuration

Aptio Setup Utility - Copyright (C) 2012 American Megatrends, Inc.	
Advanced	
PATA Primary Master	Not Present
PATA Primary Slave	Not Present
→ ←: Select Screen ↑ ↓: Select Item Enter: Select +/-: Change Opt. F1: General Help F2: Previous Values F3: Optimized Defaults F4: Save and Reset ESC: Exit	
Version 2.15.1227. Copyright (C) 2012 American Megatrends, Inc.	

Network Stack

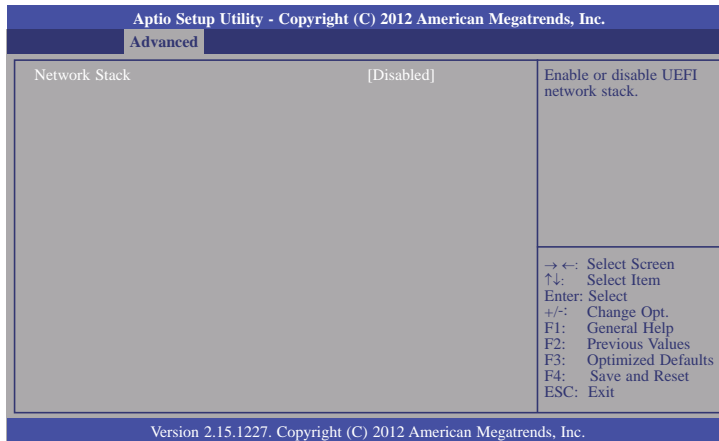

Network Stack

This field is used to enable or disable the UEFI network stack, when enabled, Ipv4 PXE Support and Ipv6 PXE Support are available to setup.

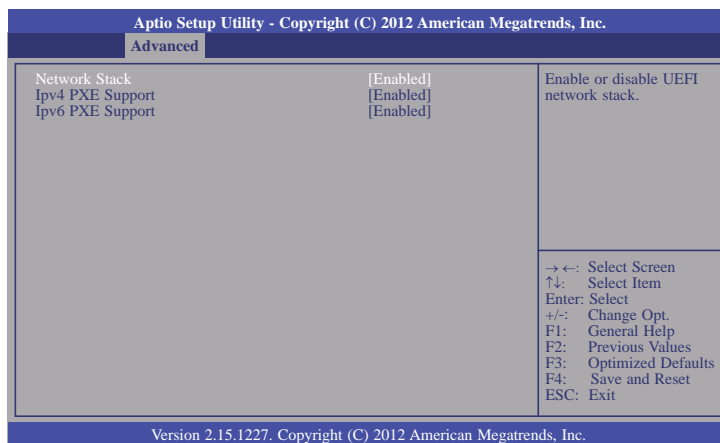

Ipv4 PXE Support

Enabled Ipv4 PXE Boot Support. If disabled Ipv4 PXE Boot option will not be created.

Ipv6 PXE Support

Enabled Ipv6 PXE Boot Support. If disabled Ipv4 PXE Boot option will not be created.

CPU PPM Configuration

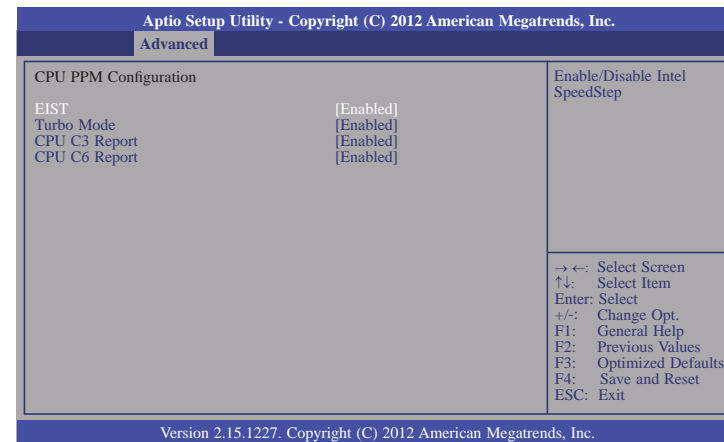

EIST

This field is used to enable or disable the Intel Enhanced SpeedStep Technology.

Turbo Mode

The options are Enabled and Disabled.

CPU C3 Report

Enabled/Disabled CPU C3 (ACPI C2) report to OS.

CPU C6 Report

Enabled/Disabled CPU C6 (ACPI C3) report to OS.

WatchDog Configuration

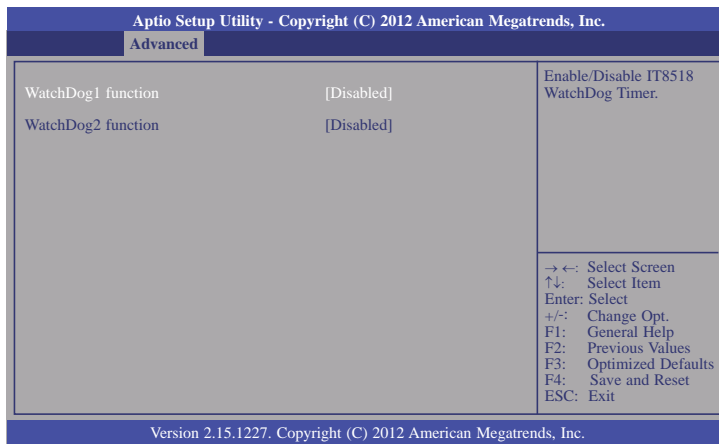

WatchDog function

This field is used to enable or disable the Watchdog timer function.

Watchdog 1 function

For CR902-B/BL module board (Reset CR902-B/BL by hardware)

Watchdog 2 function

For carrier board usage.

Chipset

Configures relevant chipset functions.

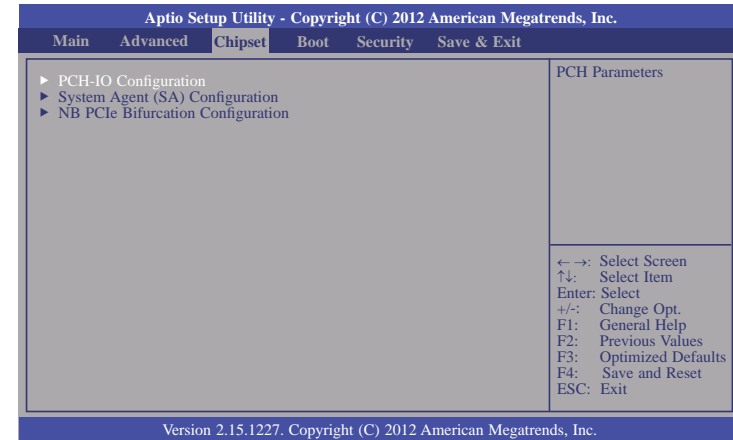

PCH-IO Configuration

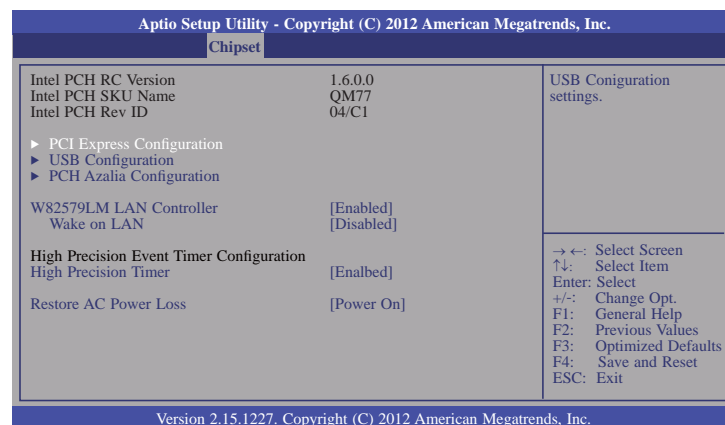
**W82579LM LAN Controller**

Enables or disables onboard NIC.

Wake on LAN Enable

Set this field to Enabled to wake up the system via the onboard LAN or via a LAN card that supports the remote wake up function.

High Precision Timer

Enabled or disable the high precision event timer.

Restore AC Power Loss

Off

When power returns after an AC power failure, the system's power is off. You must press the Power button to power-on the system.

On

When power returns after an AC power failure, the system will automatically power-on.

Former-Sts

When power returns after an AC power failure, the system will return to the state where you left off before power failure occurs. If the system's power is off when AC power failure occurs, it will remain off when power returns. If the system's power is on when AC power failure occurs, the system will power-on when power returns.

PCI Express Configuration

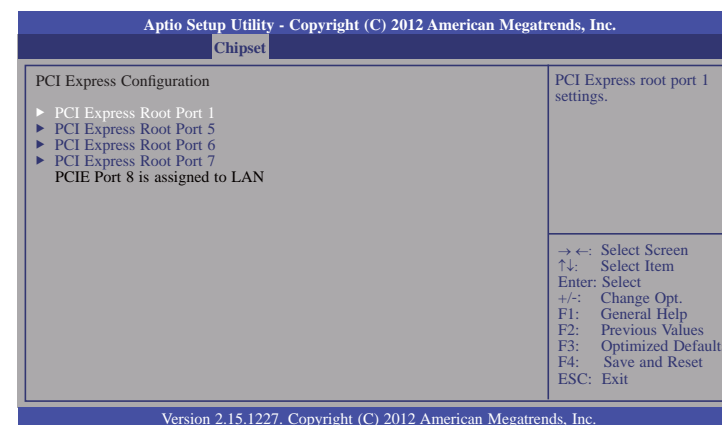
**PCI Express Root Port 1, port 5 to PCI Express Root Port 7**

Controls the PCI Express Root Port.

USB Configuration

Aptio Setup Utility - Copyright (C) 2012 American Megatrends, Inc.	
Chipset	
USB Configuration	Control the USB EHCI (USB 2.0) functions. One EHCI controller must always be enabled.
EHCI 1	[Enabled]
EHCI 2	[Enabled]
→ ←: Select Screen ↑ ↓: Select Item Enter: Select +/-: Change Opt. F1: General Help F2: Previous Values F3: Optimized Defaults F4: Save and Reset ESC: Exit	
Version 2.15.1227. Copyright (C) 2012 American Megatrends, Inc.	

PCH Azalia Configuration

Aptio Setup Utility - Copyright (C) 2012 American Megatrends, Inc.	
Chipset	
PCH Azalia Configuration	Control detection of the Azalia device. Disable= Azalia will be unconditionally disabled. Enabled= Azalia will be unconditionally enabled. Auto=Azalia will be enabled if present, disabled otherwise.
Azalia	[Auto]
→ ←: Select Screen ↑ ↓: Select Item Enter: Select +/-: Change Opt. F1: General Help F2: Previous Values F3: Optimized Defaults F4: Save and Reset ESC: Exit	
Version 2.15.1227. Copyright (C) 2012 American Megatrends, Inc.	

System Agent (SA) Configuration

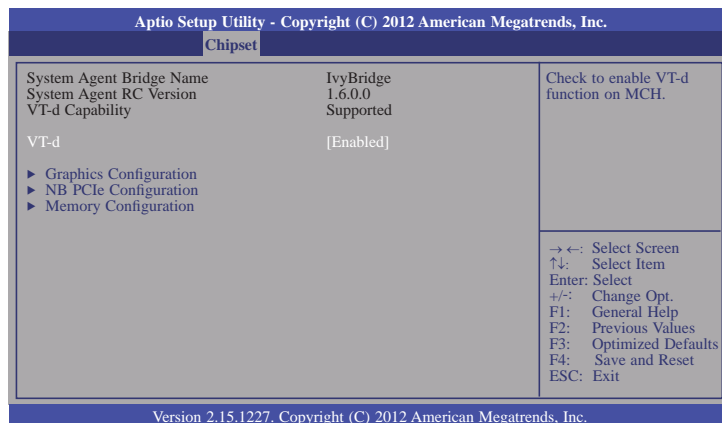

Graphics Configuration

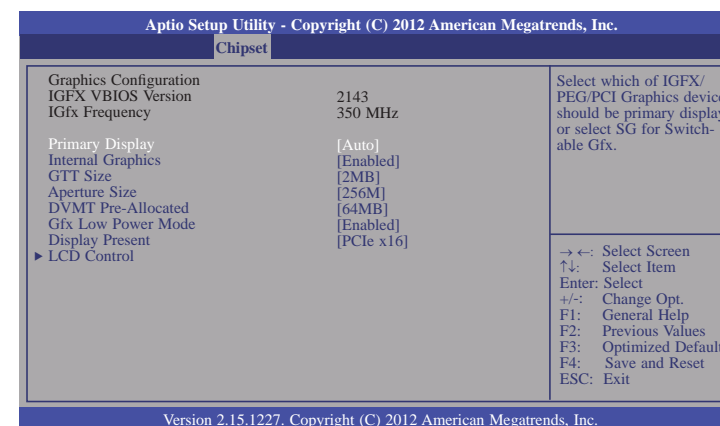

Primary Display

Auto When the system boots, it will auto detect the display device.

IGFX When the system boots, it will first initialize the onboard VGA.

PEG When the system boots, it will first initialize the PCI Express x16 graphics card.

Internal Graphics

Keep IGD enabled based on setup options.

GTT Size

Select the GTT size.

Aperture Size

Select the Aperture size.

DVMT Pre-Allocated

Select DVMT 5.0 Pre-Allocated (Fixed) Graphics Memory size used by the Internal Graphics Device.

Gfx Low Power Mode

This option is applicable for SFF only. Enable or Disable the Gfx Low Power Mode.

Display Present

Select display mode.

LCD Control

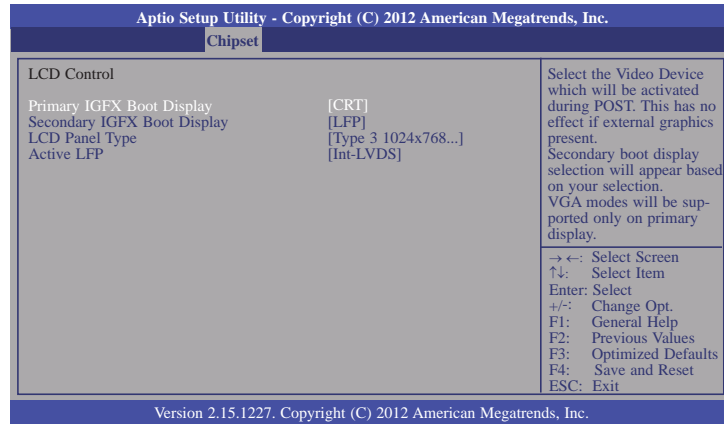

Secondary IGFX Boot Display

Select secondary display device.

LCD Panel Type

Select LCD panel used by Internal Graphics Device by selecting the appropriate setup item.

Active LFP

Select the active LFP configuration.

No LVDS VBIOS does not enable LVDS.

Int-LVDS VBIOS enables LVDS driver by intergrated encoder.

NB PCIe Configuration

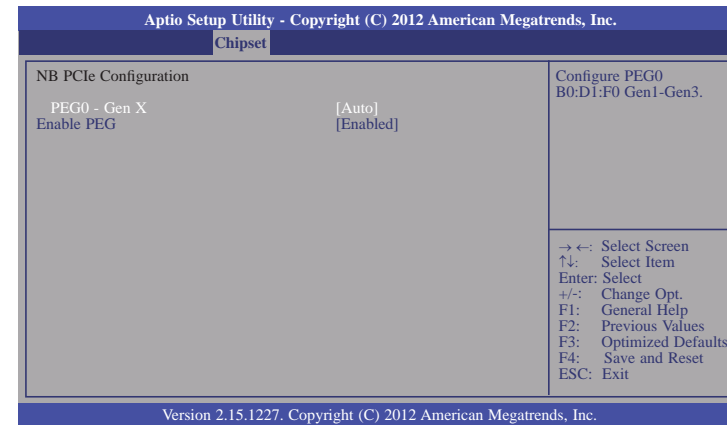

Enable PEG

To enables or disables the PEG.

Memory Configuration

Aptio Setup Utility - Copyright (C) 2012 American Megatrends, Inc.

Chipset

Memory Information		DDR3 or DDR3L selection.
Memory RC Version	1.6.0.0	
Memory Frequency	1333 Mhz	
Total Memory	2048 MB (DDR3)	
DIMM#1	2048 MB (DDR3)	
DIMM#2	Not Present	
CAS Latency (tCL)	9	
Minimum delay time		
CAS to RAS (tRCDmin)	9	
Row Precharge (tRPmin)	9	
Active to Precharge (tRASmin)	24	
DDR Selection	[DDR3]	
Memory Remap	[Enabled]	

→ ←: Select Screen
 ↑↓: Select Item
 Enter: Select
 +/-: Change Opt.
 F1: General Help
 F2: Previous Values
 F3: Optimized Defaults
 F4: Save and Reset
 ESC: Exit

Version 2.15.1227. Copyright (C) 2012 American Megatrends, Inc.

NB PCIe Bifurcation Configuration

Aptio Setup Utility - Copyright (C) 2012 American Megatrends, Inc.

Chipset

NB PCIe Bifurcation Configuration		PEG bifurcation configuration.
PEG Bifurcation	[x16]	
	<div style="border: 1px solid black; padding: 5px; width: fit-content; margin: 0 auto;"> PEG Bifurcation x8, x4, x4 Reserved x8, x8 x16 </div>	

→ ←: Select Screen
 ↑↓: Select Item
 Enter: Select
 +/-: Change Opt.
 F1: General Help
 F2: Previous Values
 F3: Optimized Defaults
 F4: Save and Reset
 ESC: Exit

Version 2.15.1227. Copyright (C) 2012 American Megatrends, Inc.

Memory Remap

To enables or disables memory remap above 4G.

Boot

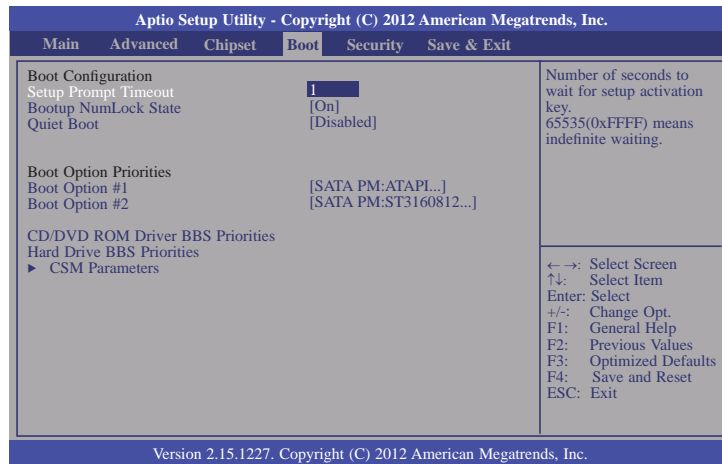

Setup Prompt Timeout

Selects the number of seconds to wait for the setup activation key. 65535(0xFFFF) denotes indefinite waiting.

Bootup NumLock State

This allows you to determine the default state of the numeric keypad. By default, the system boots up with NumLock on wherein the function of the numeric keypad is the number keys. When set to Off, the function of the numeric keypad is the arrow keys.

Quiet Boot

Enables or disables the quiet boot function.

CD/DVD ROM Driver BBS Priorities

Set the order of the legacy devices in this group.

Hard Driver BBS Priorities

Set the order of the legacy devices in this group.

CSM Parameters

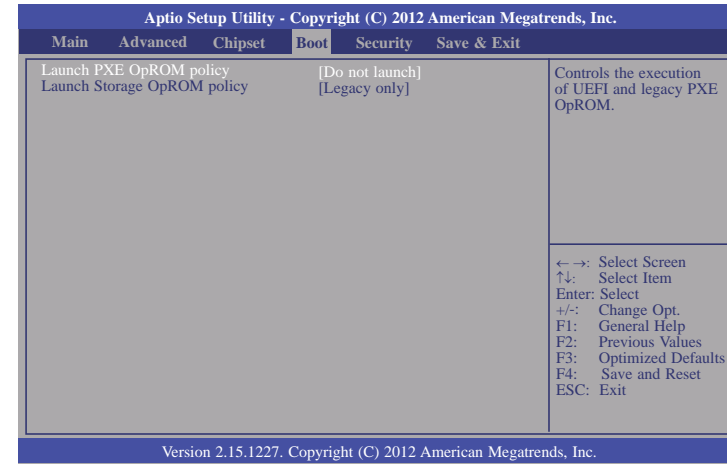

Launch Storage OpROM policy

Controls the execution of UEFI and legacy storage OpROM.

Security

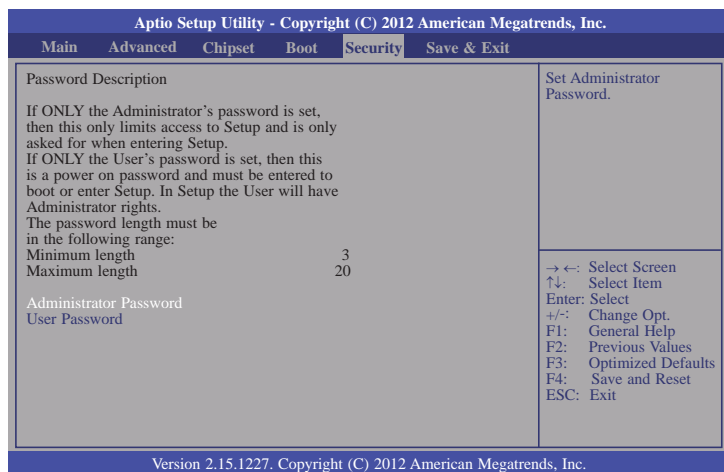

Administrator Password

Sets the administrator password.

User Password

Sets the user password.

Save & Exit

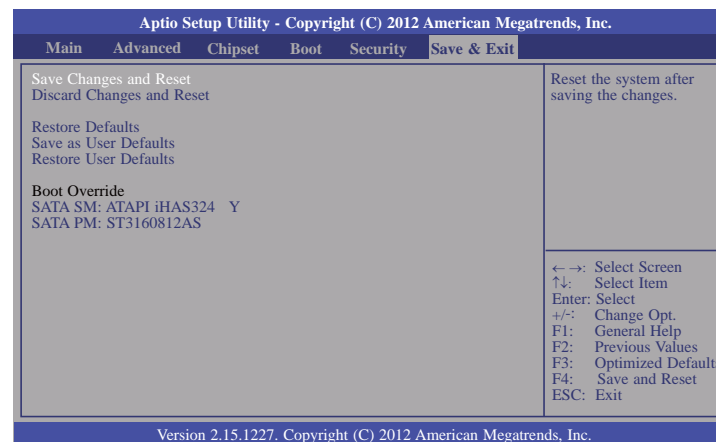

Save Changes and Reset

To save the changes, select this field and then press <Enter>. A dialog box will appear. Select Yes to reset the system after saving all changes made.

Discard Changes and Reset

To discard the changes, select this field and then press <Enter>. A dialog box will appear. Select Yes to reset the system setup without saving any changes.

Restore Defaults

To restore and load the optimized default values, select this field and then press <Enter>. A dialog box will appear. Select Yes to restore the default values of all the setup options.

Save as User Defaults

To save changes done so far as user default, select this field and then press <Enter>. A dialog box will appear. Select Yes to save values as user default.

Restore User Defaults

To restore user default to all the setup options, select this field and then press <Enter>. A dialog box will appear. Select Yes to restore user default.

Updating the BIOS

To update the BIOS, you will need the new BIOS file and a flash utility, AFUDOS.EXE. Please contact technical support or your sales representative for the files.

To execute the utility, type:

A:> AFUDOS BIOS_File_Name /b /p /n
then press <Enter>.

```
C:\AFU\AFUDOS>afudos filename /B /P /N
+-----+
|              AMI Firmware Update Utility(APTIO) v2.25              |
|              Copyright (C)2008 American Megatrends Inc. All Rights Reserved.              |
+-----+
Reading file ..... done
Erasing flash ..... done
Writing flash ..... done
Verifying flash ..... done
Erasing BootBlock ..... done
Writing BootBlock ..... done
Verifying BootBlock ..... done

C:\AFU\AFUDOS>
```

After finishing BIOS update, please turn off the AC power. Wait about 10 seconds and then turn on the AC power again.

Notice: BIOS SPI ROM

1. The Intel® Management Engine has already been integrated into this system board. Due to the safety concerns, the BIOS (SPI ROM) chip cannot be removed from this system board and used on another system board of the same model.
2. The BIOS (SPI ROM) on this system board must be the original equipment from the factory and cannot be used to replace one which has been utilized on other system boards.
3. If you do not follow the methods above, the Intel® Management Engine will not be updated and will cease to be effective.

Note:



- a. You can take advantage of flash tools to update the default configuration of the BIOS (SPI ROM) to the latest version anytime.
- b. When the BIOS IC needs to be replaced, you have to populate it properly onto the system board after the EEPROM programmer has been burned and follow the technical person's instructions to confirm that the MAC address should be burned or not.

Chapter 5 - Supported Software

The CD that came with the system board contains drivers, utilities and software applications required to enhance the performance of the system board.

Insert the CD into a CD-ROM drive. The autorun screen (Mainboard Utility CD) will appear. If after inserting the CD, "Autorun" did not automatically start (which is, the Mainboard Utility CD screen did not appear), please go directly to the root directory of the CD and double-click "Setup".

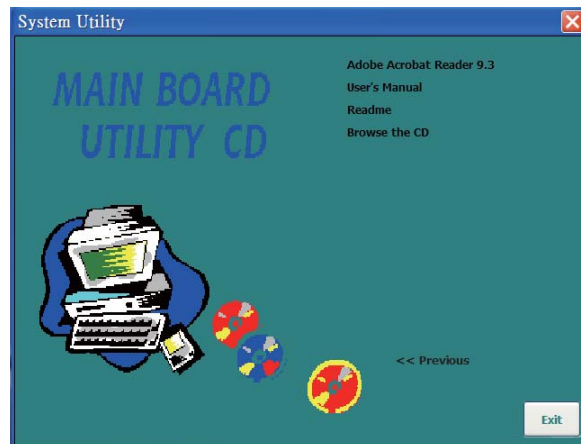
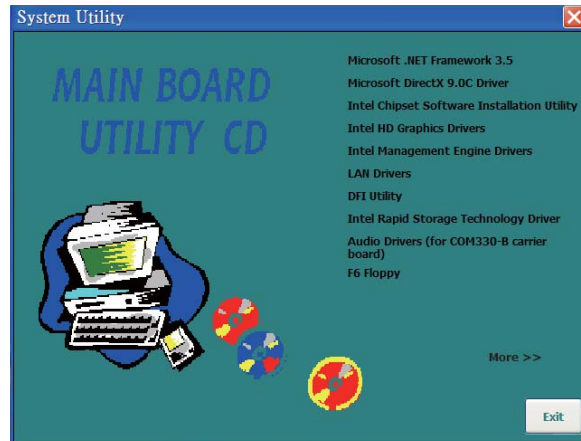

Auto Run Pages (for Windows 7)

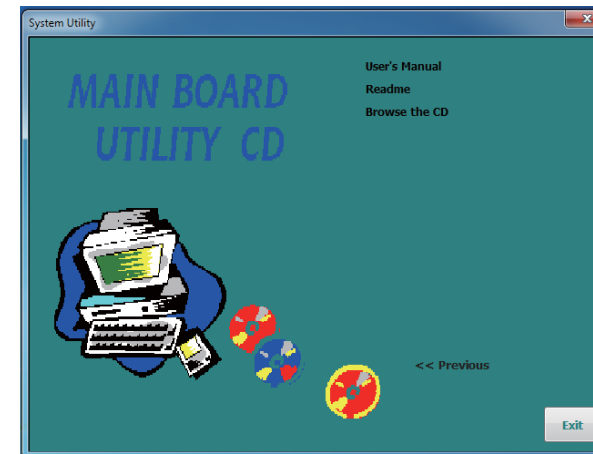
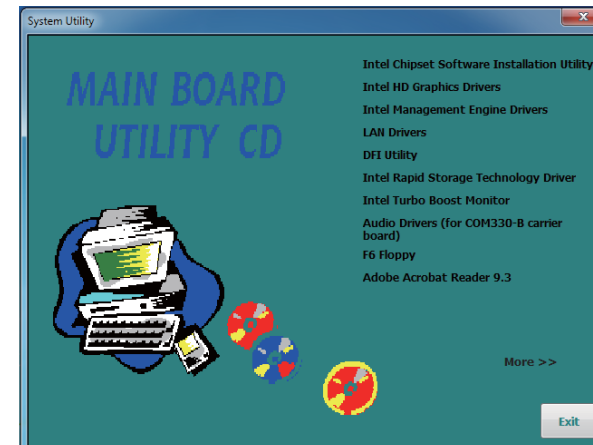

Microsoft .NET Framework 3.5 (for Windows XP)



Note:

Before installing Microsoft .NET Framework 3.5, make sure you have updated your Windows XP operating system to Service Pack 3.

To install the driver, click "Microsoft .NET Framework 3.5" on the main menu.

1. Read the license agreement carefully.

Click "I have read and accept the terms of the License Agreement" then click Install.

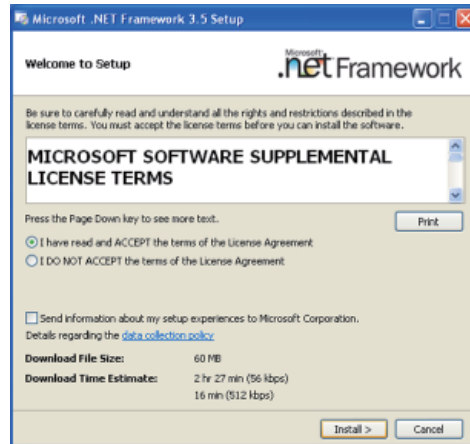

2. Setup is now installing the driver.

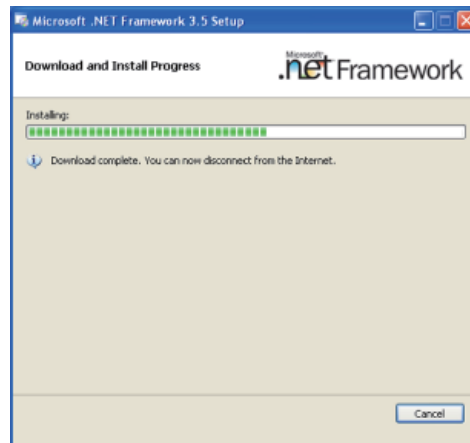

3. Click Exit.

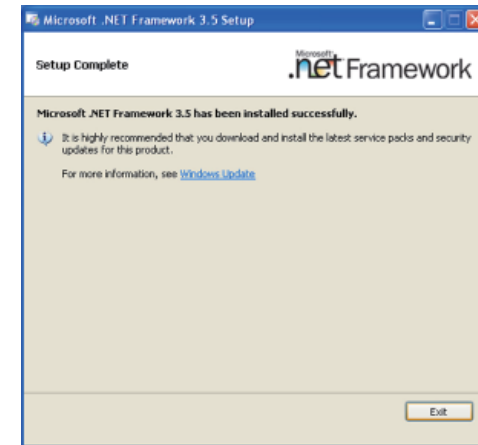

Microsoft DirectX 9.0C Driver

(for Windows XP only)

To install the utility, click "Microsoft DirectX 9.0C Driver" on the main menu.

1. Click "I accept the agreement" then click Next.

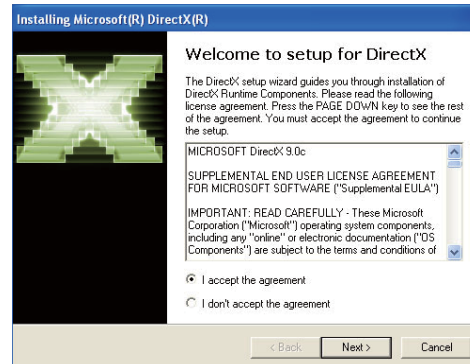

2. To start installation, click Next.

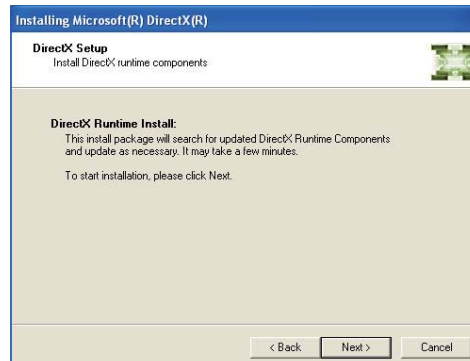

3. Click Finish. Reboot the system for DirectX to take effect.

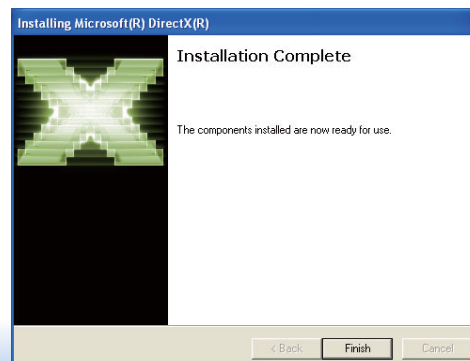

Intel Chipset Device Software

The Intel Chipset Device Software is used for updating Windows® INF files so that the Intel chipset can be recognized and configured properly in the system.

To install the utility, click "Intel Chipset Device Software" on the main menu.

1. Setup is ready to install the utility. Click Next.



2. Read the license agreement then click Yes.

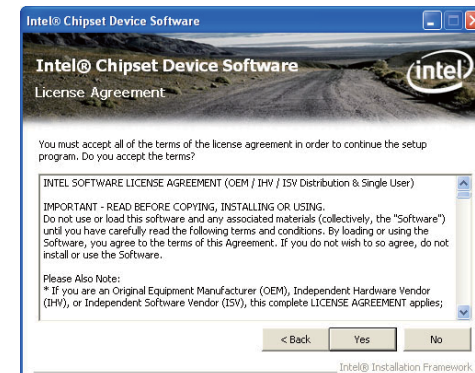

- Go through the readme document for more installation tips then click Next.

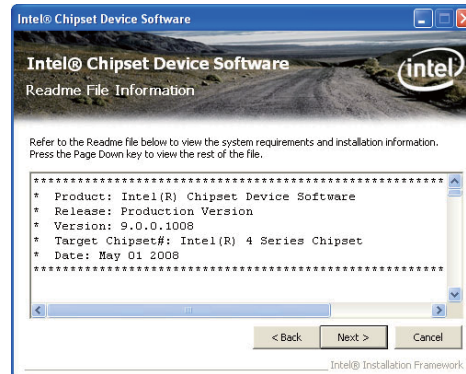

- After all setup operations are done, click Next.



- Click "Yes, I want to restart this computer now" then click Finish.

Restarting the system will allow the new software installation to take effect.



Intel HD Graphics Drivers (for Windows 7/ Windows 8)

To install the driver, click "Intel HD Graphics Drivers" on the main menu.

- Setup is now ready to install the graphics driver. Click Next.



By default, the "Automatically run WinSAT and enable the Windows Aero desktop theme" is enabled. With this enabled, after installing the graphics driver and the system rebooted, the screen will turn blank for 1 to 2 minutes (while WinSAT is running) before the Windows 7/ Windows 8 desktop appears. The "blank screen" period is the time Windows is testing the graphics performance.

We recommend that you skip this process by disabling this function then click Next.

2. Read the license agreement then click Yes.

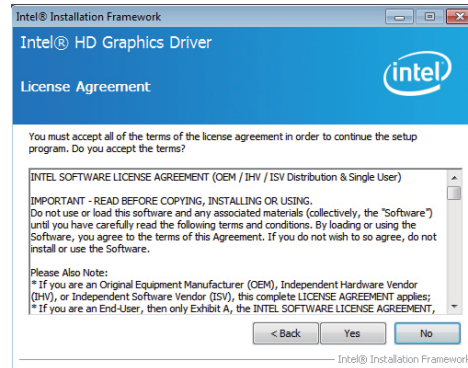

3. Go through the readme document for system requirements and installation tips then click Next.

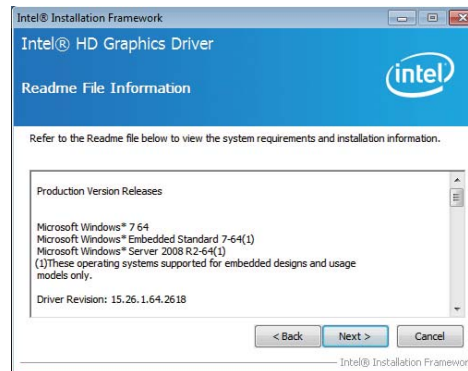

4. Setup is now installing the driver. Click Next to continue.

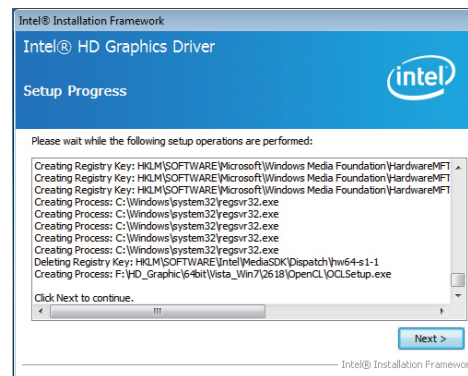

5. Click "Yes, I want to restart this computer now" then click Finish.

Restarting the system will allow the new software installation to take effect.

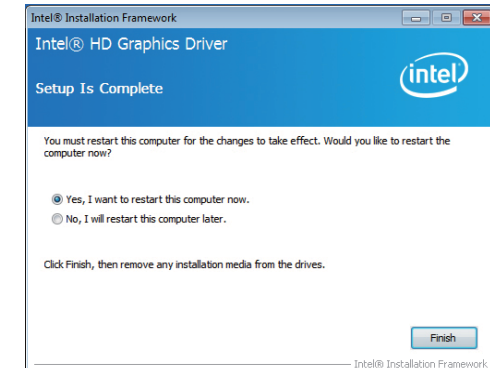

Intel HD Graphics Drivers (for Windows XP)



Note:

Before installing Intel HD Graphics Drivers, make sure you have installed Microsoft .NET Framework 3.5 SP1.

To install the driver, click “Intel HD Graphics Drivers” on the main menu.

1. Setup is ready to install the graphics driver. Click Next.

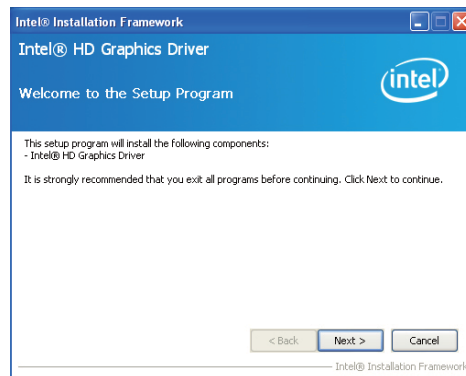

2. Read the license agreement then click Yes.

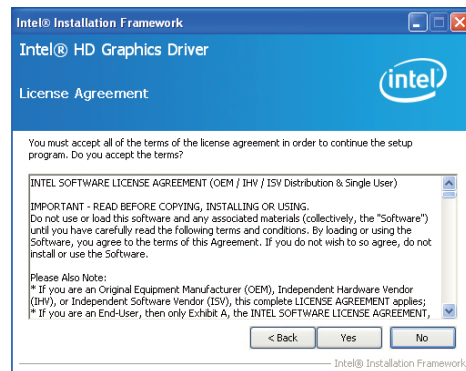

3. Go through the readme document for more installation tips then click Next.

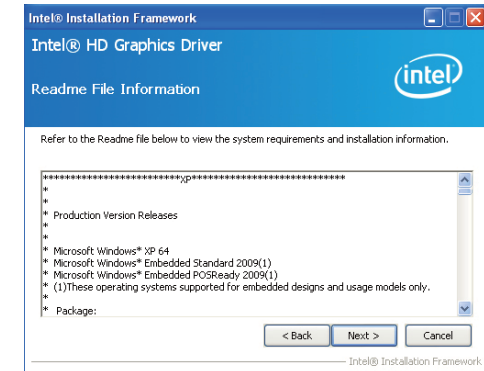

4. Setup is currently installing the driver. After installation has completed, click Next.

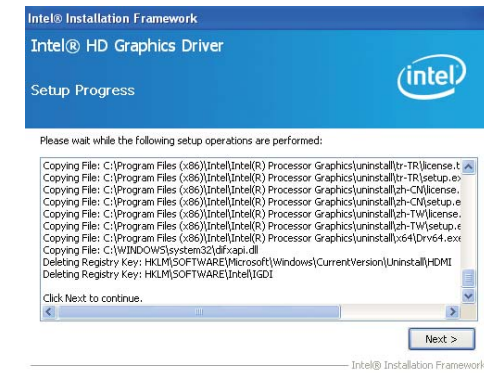

5. Click “Yes, I want to restart this computer now.” then click Finish.

Restarting the system will allow the new software installation to take effect.

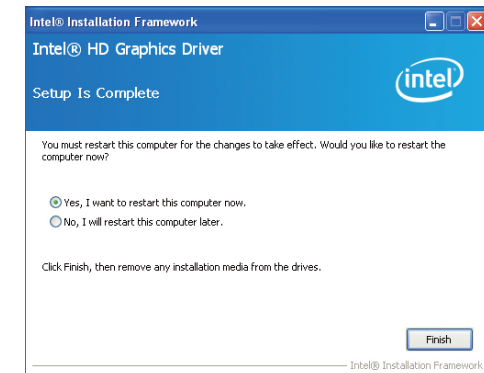

Intel Management Engine Drivers

To install the driver, click "Intel Management Engine Drivers" on the main menu.

1. Setup is ready to install the driver. Click Next.

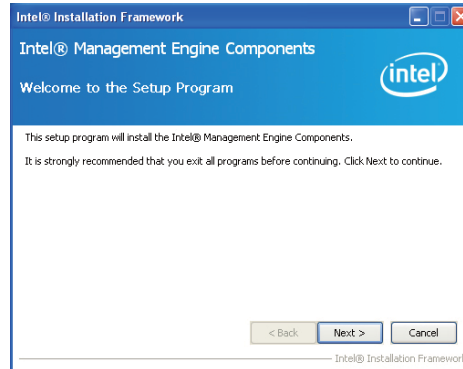

2. Read the license agreement then click Yes.

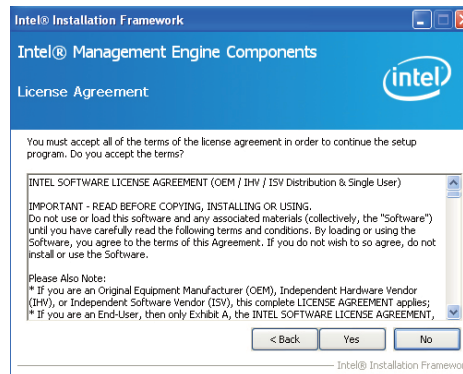

3. Setup is currently installing the driver. After installation has completed, click Next.

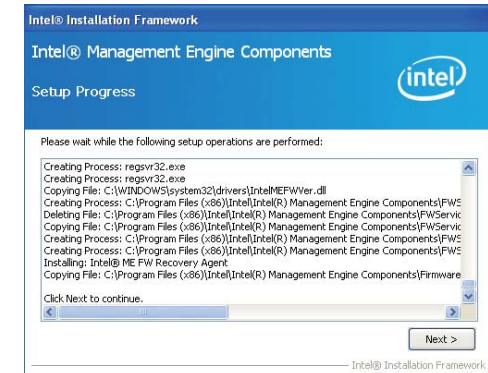

4. After completing installation, click Finish.

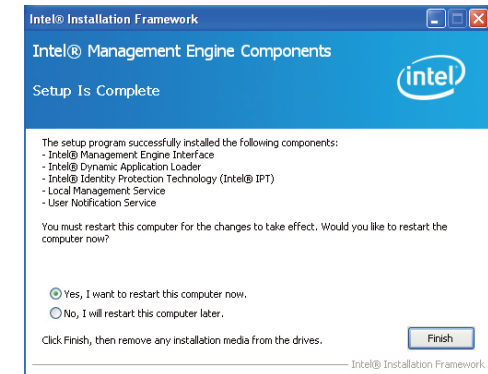

LAN Drivers

To install the driver, click “LAN Drivers” on the main menu.

1. Setup is ready to install the driver.
Click Install Drivers and Software.

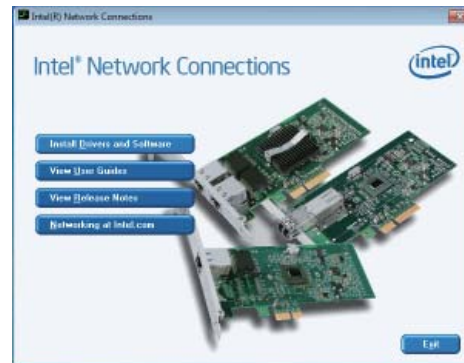

2. Setup is now ready to install the LAN driver. Click Next.

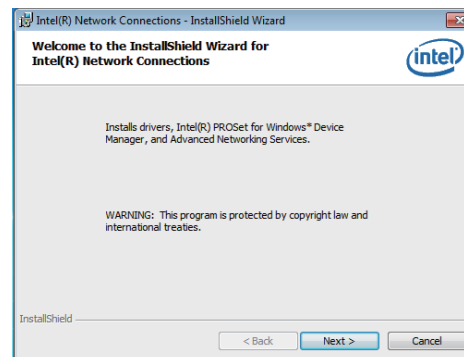

3. Click “I accept the terms in the license agreement” then click Next.

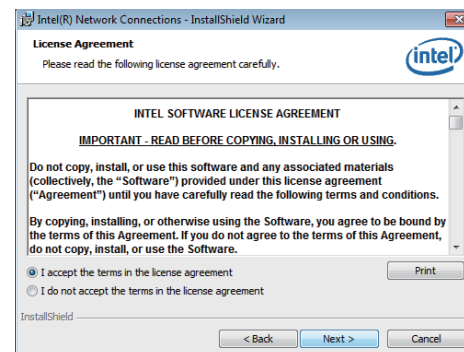

4. Select the program features you want installed then click Next.

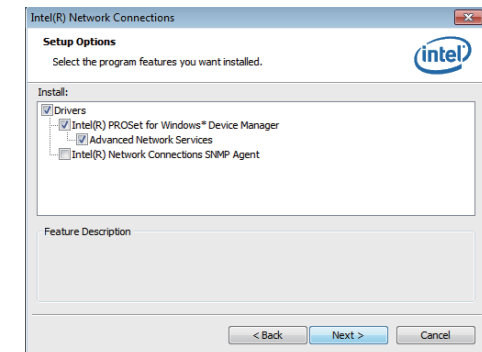

5. Click Install to begin the installation.

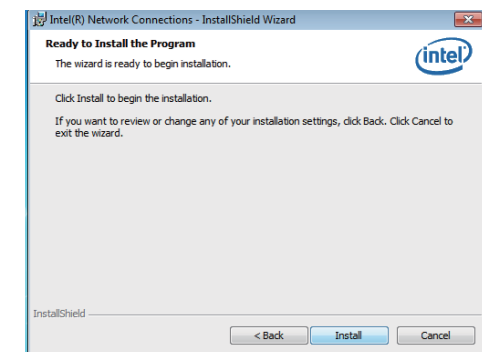

6. After completing installation, click Finish.

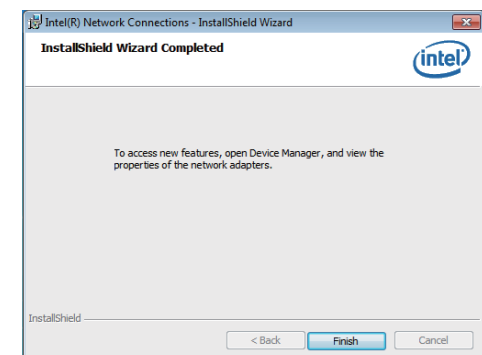

DFI Utility

DFI Utility provides information about the board, HW Health, Watchdog, DIO, and Backlight. To access the utility, click “DFI Utility” on the main menu.



Note:

If you are using Windows 7, you need to access the operating system as an administrator to be able to install the utility.

1. Setup is ready to install the DFI Utility driver. Click Next.



2. Click “I accept the terms in the license agreement” and then click Next.

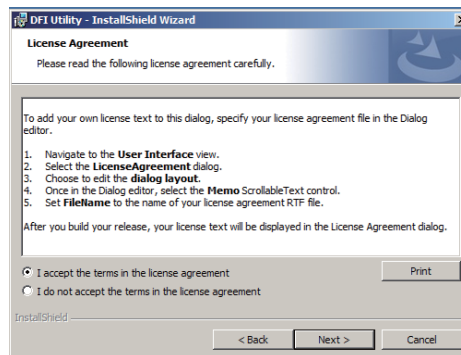

3. Enter “User Name” and “Organization” information and then click Next.

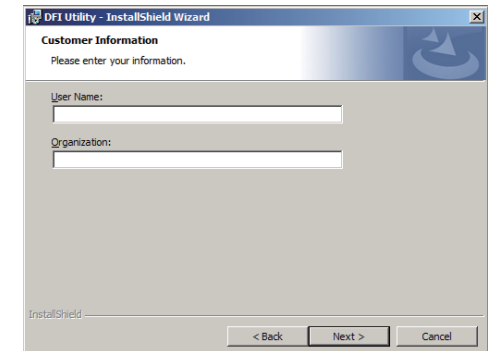

4. Click Install to begin the installation.

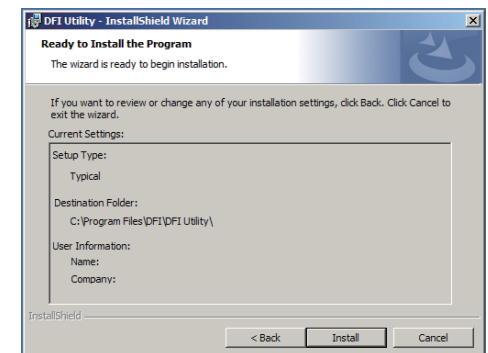

5. After completing installation, click Finish.

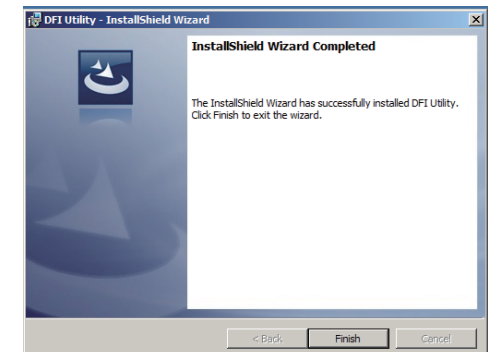

The DFI Utility icon will appear on the desktop. Double-click the icon to open the utility.

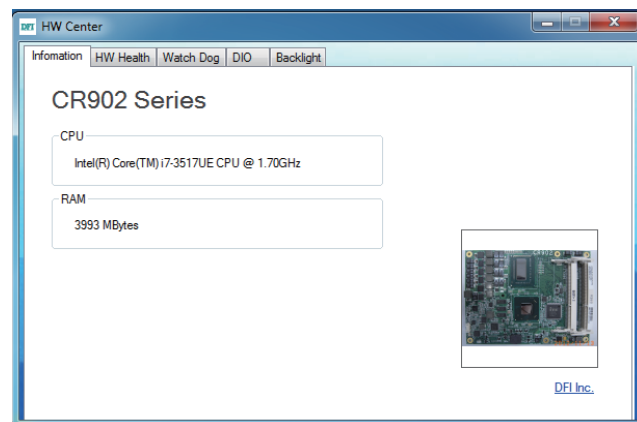

Intel Rapid Storage Technology

The Intel Rapid Storage Technology is a utility that allows you to monitor the current status of the SATA drives. It enables enhanced performance and power management for the storage subsystem.

To install the driver, click “Intel Rapid Storage Technology” on the main menu.



Note:
Windows Vista is not supported.

1. Setup is now ready to install the utility. Click Next.

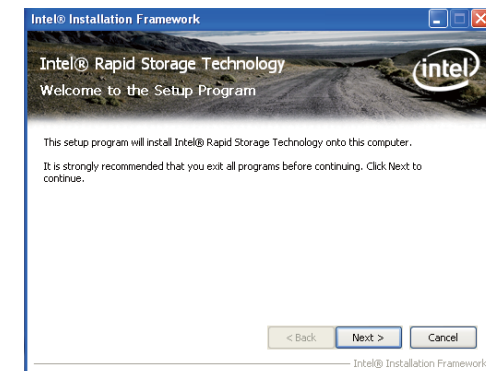

2. Read the warning then click Yes.



3. Read the license agreement then click Yes.

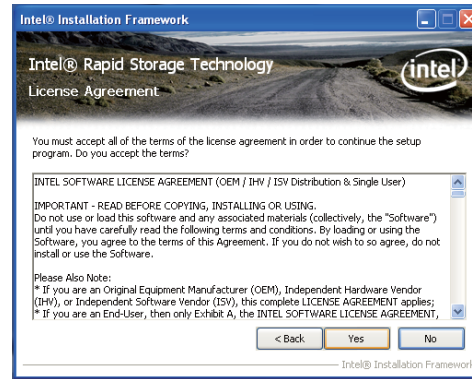

4. Go through the readme document for system requirements and installation tips then click Next.

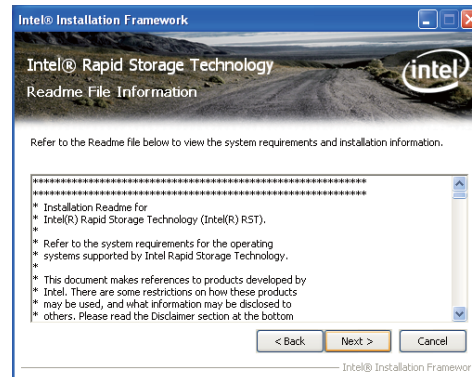

5. Setup is now installing the utility. Click Next to continue.

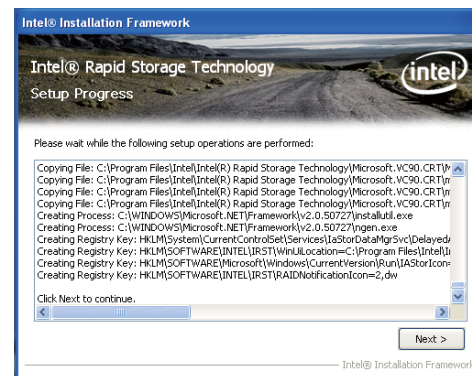

6. Click "Yes, I want to restart my computer now" then click Finish.

Restarting the system will allow the new software installation to take effect.

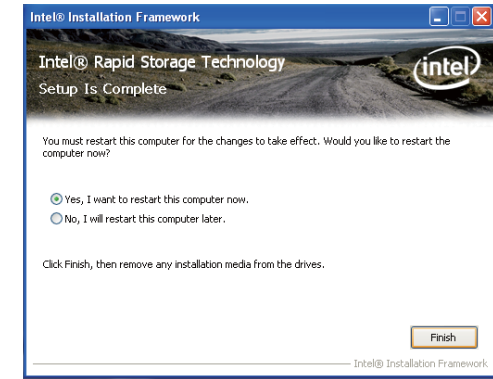

7. Run the Intel Matrix Storage Console utility to view the hard drives' configuration.

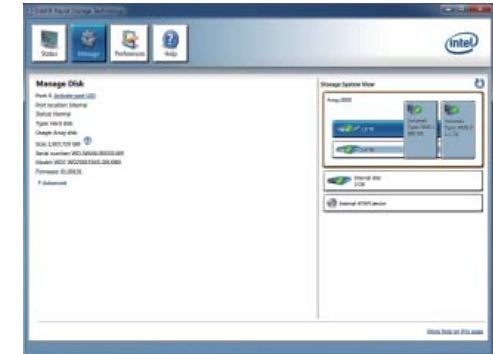

Intel Turbo Boost Monitor (for Windows 7 only)

To install the driver, click “Intel Turbo Boost Monitor” on the main menu.

1. The setup program is configuring the new software installation.



2. Click Next.

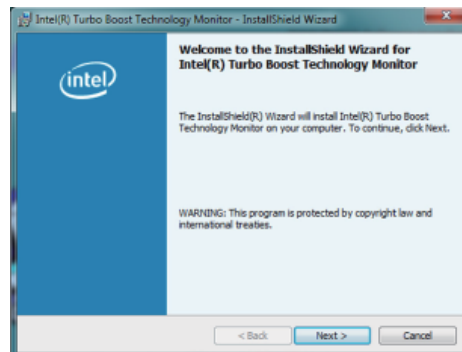

3. Read the license agreement and then click “I accept the terms in the license agreement”. Click Next.



4. Click Install.



5. The setup program is currently installing the software.

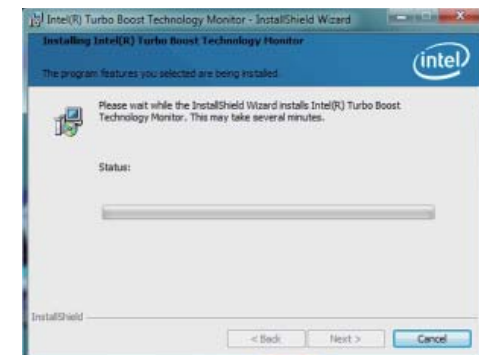

6. Click Finish.



Audio Drivers (for COM330-B Carrier Board)

To install the driver, click “Audio Drivers (for COM330-B Carrier Board)” on the main menu.

1. Setup is now ready to install the audio driver. Click Next.
2. Follow the remainder of the steps on the screen; clicking “Next” each time you finish a step.

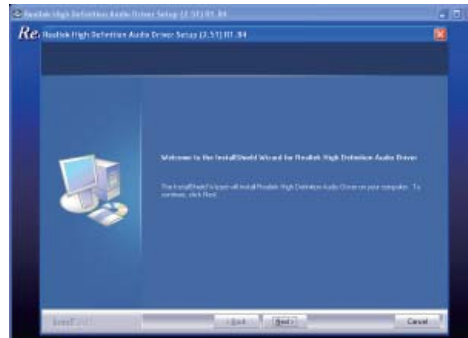

3. Click “Yes, I want to restart my computer now” then click Finish.

Restarting the system will allow the new software installation to take effect.

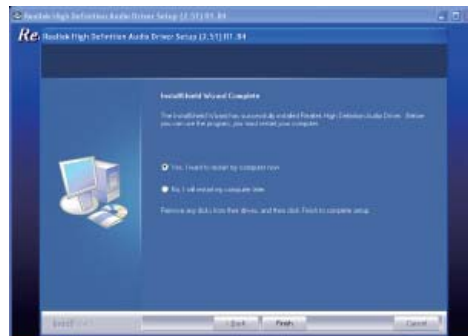

F6 Floppy

This is used to create a floppy driver diskette needed when you install Windows® XP using the F6 installation method. This will allow you to install the operating system onto a hard drive when in AHCI mode.

1. Insert a blank floppy diskette.
2. Locate for the drivers in the CD then copy them to the floppy diskette. The CD includes drivers for both 32-bit and 64-bit operating systems. The path to the drivers are shown below.

32-bit

CD Drive:\IRST\WINDOWS\flpy-x86

64-bit

CD Drive:\IRST\WINDOWS\flpy-x64

Adobe Acrobat Reader 9.3

To install the reader, click “Adobe Acrobat Reader 9.3” on the main menu.

1. Click Next to install or click Change Destination Folder to select another folder.

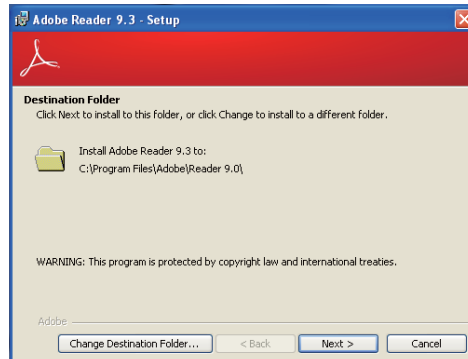

2. Click Install to begin installation.

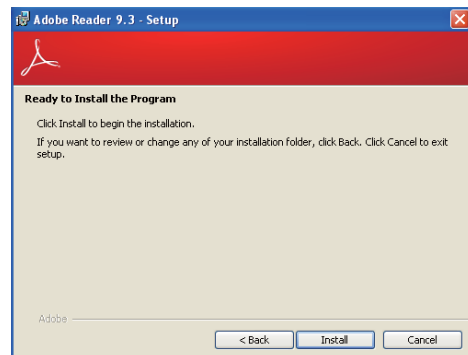

3. Click Finish to exit installation.

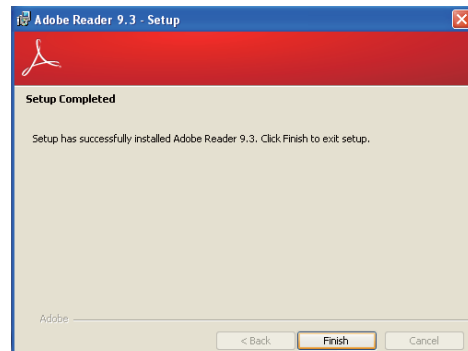

Appendix A - NLITE and AHCI Installation Guide

nLite

nLite is an application program that allows you to customize your XP installation disc by integrating the RAID/AHCI drivers into the disc. By using nLite, the F6 function key usually required during installation is no longer needed.



Note:

The installation steps below are based on nLite version 1.4.9. Installation procedures may slightly vary if you're using another version of the program.

1. Download the program from nLite's official website.

<http://www.nliteos.com/download.html>

2. Install nLite.



Important:

Due to it's coding with Visual.Net, you may need to first install .NET Framework prior to installing nLite.

3. Download relevant RAID/AHCI driver files from Intel's website. The drivers you choose will depend on the operating system and chipset used by your computer.

The downloaded driver files should include iaahci.cat, iaAHCI.inf, iastor.cat, iaStor.inf, IaStor.sys, license.txt and TXTSETUP.OEM.

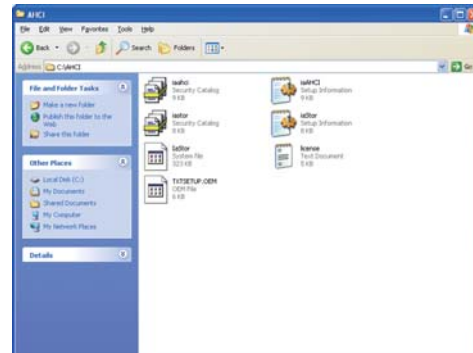

4. Insert the XP installation disc into an optical drive.
5. Launch nLite. The Welcome screen will appear. Click Next.

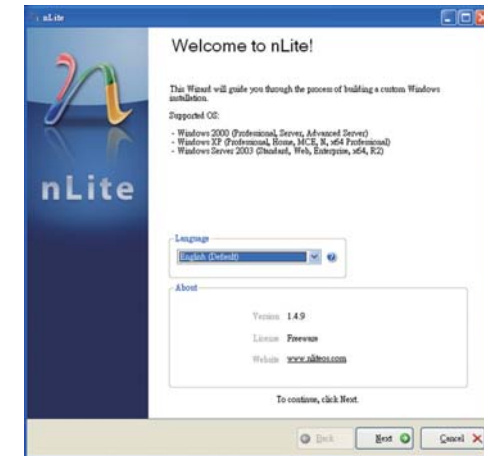

6. Click Next to temporarily save the Windows installation files to the designated default folder.

If you want to save them in another folder, click Browse, select the folder and then click Next.

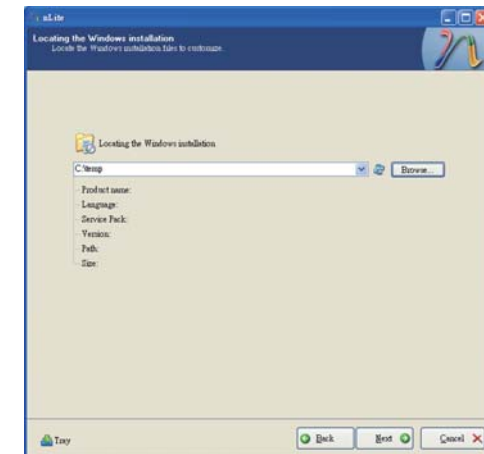

7. Click Next.

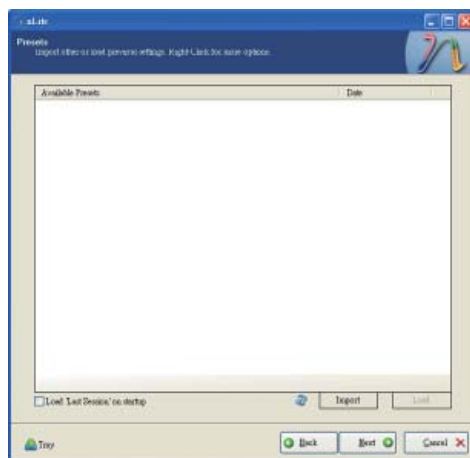

8. In the Task Selection dialog box, click Drivers and Bootable ISO. Click Next.



9. Click Insert and then select Multiple driver folder to select the drivers you will integrate. Click Next.

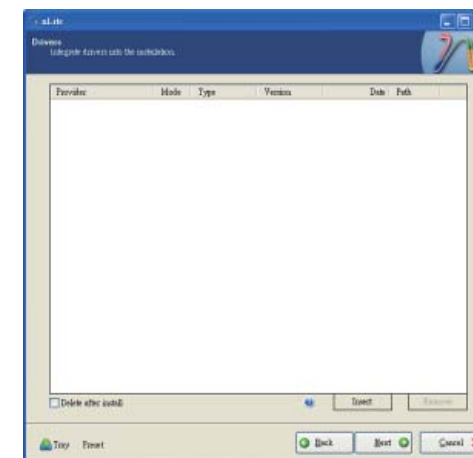

10. Select only the drivers appropriate for the Windows version that you are using and then click OK.

Integrating 64-bit drivers into 32-bit Windows or vice versa will cause file load errors and failed installation.

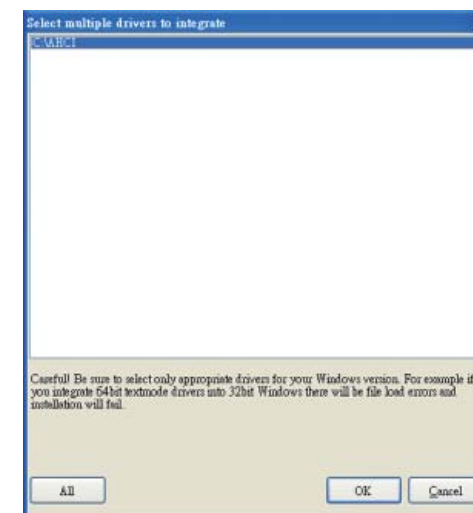

11. If you are uncertain of the southbridge chip used on your motherboard, select all RAID/AHCI controllers and then click OK.



12. Click Next.

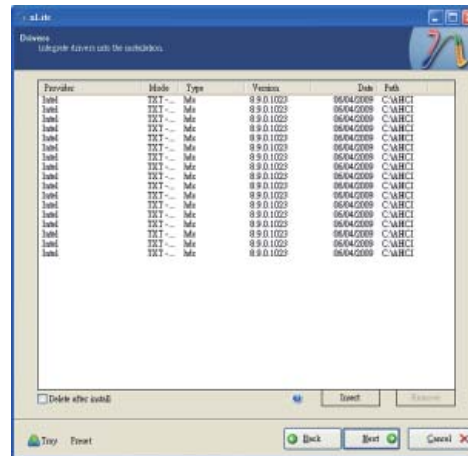

13. The program is currently integrating the drivers and applying changes to the installation.

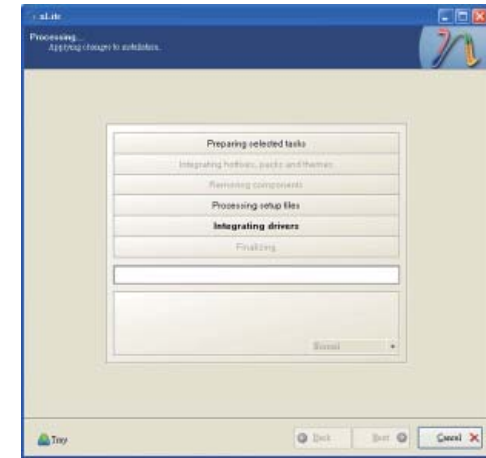

14. When the program is finished applying the changes, click Next.

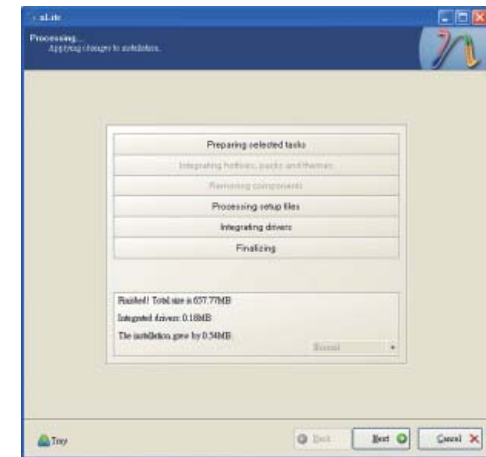

15. To create an image, select the Create Image mode under the General section and then click Next.

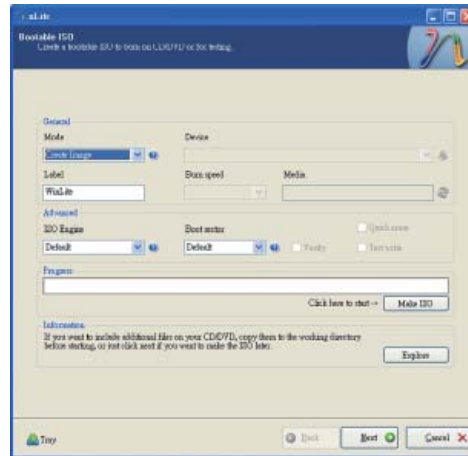

16. Or you can choose to burn it directly to a disc by selecting the Direct Burn mode under the General section.

Select the optical device and all other necessary settings and then click Next.

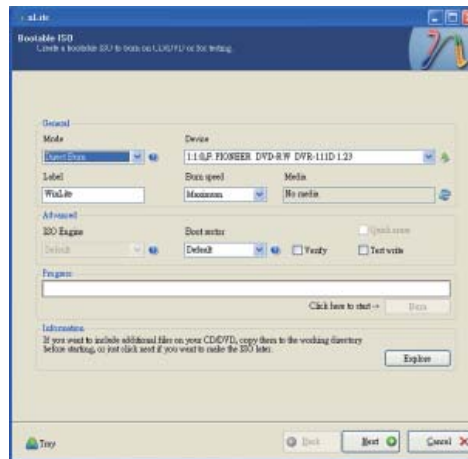

17. You have finished customizing the Windows XP installation disc. Click Finish.

Enter the BIOS utility to configure the SATA controller to RAID/AHCI. You can now install Windows XP.

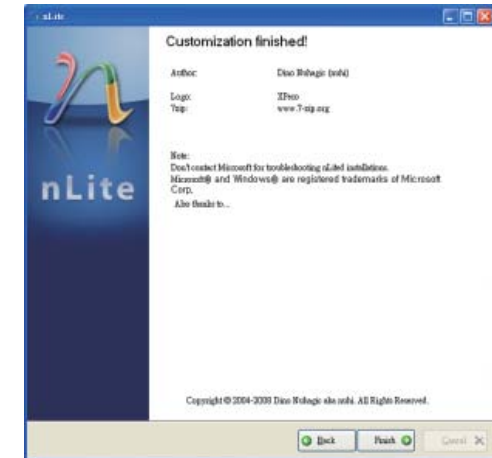

AHCI

The installation steps below will guide you in configuring your SATA drive to AHCI mode.

1. Enter the BIOS utility and configure the SATA controller to IDE mode.
2. Install Windows XP but do not press F6.
3. Download relevant RAID/AHCI driver files supported by the motherboard chipset from Intel's website.

Transfer the downloaded driver files to C:\AHCI.

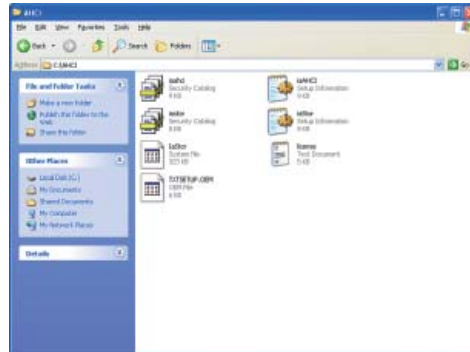

4. Open Device Manager and right click on one of the Intel Serial ATA Storage Controllers, then select Update Driver.

If the controller you selected did not work, try selecting another one.

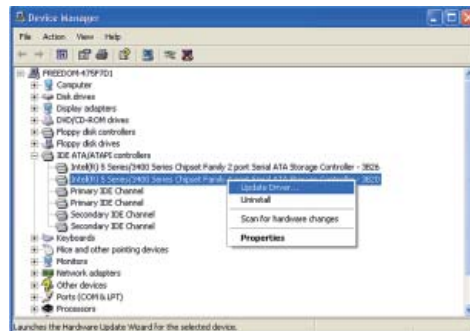

5. In the Hardware Update Wizard dialog box, select "No, not this time" then click Next.



6. Select "Install from a list or specific location (Advanced)" and then click Next.

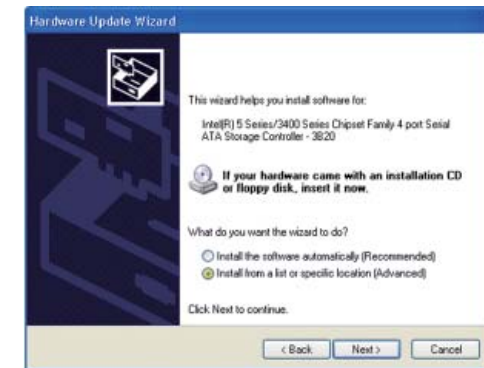

7. Select "Don't search. I will choose the driver to install" and then click Next.

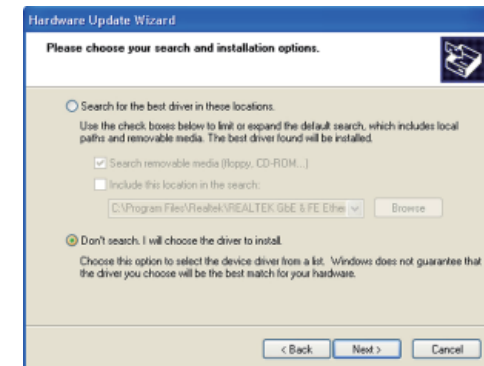

8. Click "Have Disk".

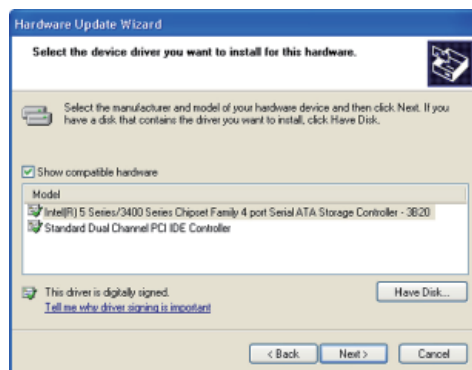

9. Select C:\AHCI\iaAHCI.inf and then click Open.

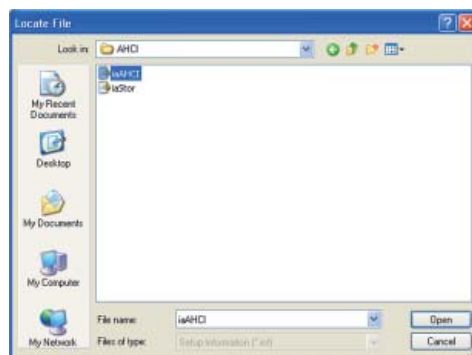

10. Select the appropriate AHCI Controller of your hardware device and then click Next.

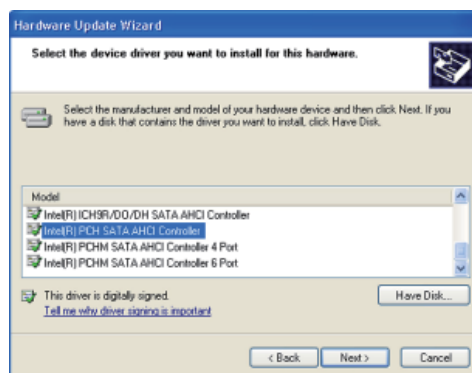

11. A warning message appeared because the selected SATA controller did not match your hardware device.

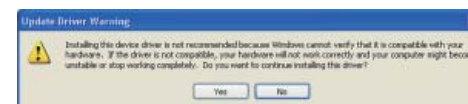

Ignore the warning and click Yes to proceed.

12. Click Finish.

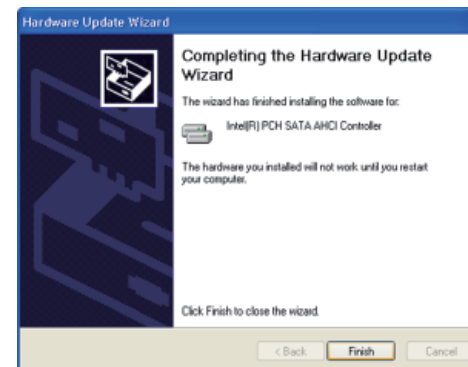

13. The system's settings have been changed. Windows XP requires that you restart the computer. Click Yes.



14. Enter the BIOS utility and modify the SATA controller from IDE to AHCI. By doing so, Windows will work normally with the SATA controller that is in AHCI mode.

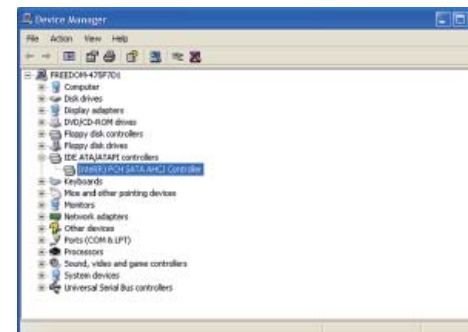

Appendix B - Watchdog Sample Code

```

#include <stdio.h>
//-----
#define EC_EnablePort 0x66
#define EC_DataPort 0x62
//-----
void WriteEC(char,int);
void SetWdTime(int,int);
int GetWdTime(void);
//-----
main()
{
    unsigned int countdown;
    unsigned int input,count_h,count_l;

    printf("Input WD Time: ");
    scanf("%d",&input);
    printf("\n");
    count_h=input>>8;
    count_l=input&0x00FF;
    SetWdTime(count_h,count_l);

    while(1)
    {
        countdown = GetWdTime();
        delay(100);
        printf("\rTime Remaining: %d ",countdown);
    }
}
//-----
void SetWdTime(int count_H,int count_L)
{
    //Set Count
    WriteEC(0xB7,count_H); //High Byte
    WriteEC(0xB8,count_L); //Low Byte
    //Enable Watch Dog Timer
    WriteEC(0xB4,0x02);
}
//-----

int GetWdTime(void)
{
    int sum,data_h,data_l;
    //Select EC Read Type
    outportb(EC_EnablePort,0x80);
    delay(5);
    //Get Remaining Count High Byte
    outportb(EC_DataPort,0xF6);
    delay(5);
    data_h=inportb(EC_DataPort);
    delay(5);
    //Select EC Read Type
    outportb(EC_EnablePort,0x80);
    delay(5);
    //Get Remaining Count Low Byte
    outportb(EC_DataPort,0xF7);
    delay(5);
    data_l=inportb(EC_DataPort);
    delay(5);

    data_h<=8;
    data_h&=0xFF00;
    sum=data_h|data_l;
    return sum;
}
//-----
void WriteEC(char EC_Addr, int data)
{
    //Select EC Write Type
    outportb(EC_EnablePort,0x81);
    delay(5);
    outportb(EC_DataPort,EC_Addr);
    delay(5);
    outportb(EC_DataPort,data);
    delay(5);
}
//-----

```

Appendix C - System Error Message

When the BIOS encounters an error that requires the user to correct something, either a beep code will sound or a message will be displayed in a box in the middle of the screen and the message, PRESS F1 TO CONTINUE, CTRL-ALT-ESC or DEL TO ENTER SETUP, will be shown in the information box at the bottom. Enter Setup to correct the error.

Error Messages

One or more of the following messages may be displayed if the BIOS detects an error during the POST. This list indicates the error messages for all Awards BIOSes:

CMOS BATTERY HAS FAILED

The CMOS battery is no longer functional. It should be replaced.

**Important:**

Danger of explosion if battery incorrectly replaced. Replace only with the same or equivalent type recommended by the manufacturer. Dispose of used batteries according to the battery manufacturer's instructions.

CMOS CHECKSUM ERROR

Checksum of CMOS is incorrect. This can indicate that CMOS has become corrupt. This error may have been caused by a weak battery. Check the battery and replace if necessary.

DISPLAY SWITCH IS SET INCORRECTLY

The display switch on the motherboard can be set to either monochrome or color. This indicates the switch is set to a different setting than indicated in Setup. Determine which setting is correct, either turn off the system and change the jumper or enter Setup and change the VIDEO selection.

Appendix D - Troubleshooting

Troubleshooting Checklist

This chapter of the manual is designed to help you with problems that you may encounter with your personal computer. To efficiently troubleshoot your system, treat each problem individually. This is to ensure an accurate diagnosis of the problem in case a problem has multiple causes.

Some of the most common things to check when you encounter problems while using your system are listed below.

1. The power switch of each peripheral device is turned on.
2. All cables and power cords are tightly connected.
3. The electrical outlet to which your peripheral devices are connected is working. Test the outlet by plugging in a lamp or other electrical device.
4. The monitor is turned on.
5. The display's brightness and contrast controls are adjusted properly.
6. All add-in boards in the expansion slots are seated securely.
7. Any add-in board you have installed is designed for your system and is set up correctly.

Monitor/Display

If the display screen remains dark after the system is turned on:

1. Make sure that the monitor's power switch is on.
2. Check that one end of the monitor's power cord is properly attached to the monitor and the other end is plugged into a working AC outlet. If necessary, try another outlet.
3. Check that the video input cable is properly attached to the monitor and the system's display adapter.
4. Adjust the brightness of the display by turning the monitor's brightness control knob.

The picture seems to be constantly moving.

1. The monitor has lost its vertical sync. Adjust the monitor's vertical sync.
2. Move away any objects, such as another monitor or fan, that may be creating a magnetic field around the display.
3. Make sure your video card's output frequencies are supported by this monitor.

The screen seems to be constantly wavering.

1. If the monitor is close to another monitor, the adjacent monitor may need to be turned off. Fluorescent lights adjacent to the monitor may also cause screen wavering.

Power Supply

When the computer is turned on, nothing happens.

1. Check that one end of the AC power cord is plugged into a live outlet and the other end properly plugged into the back of the system.
2. Make sure that the voltage selection switch on the back panel is set for the correct type of voltage you are using.
3. The power cord may have a "short" or "open". Inspect the cord and install a new one if necessary.

Hard Drive

Hard disk failure.

1. Make sure the correct drive type for the hard disk drive has been entered in the BIOS.
2. If the system is configured with two hard drives, make sure the bootable (first) hard drive is configured as Master and the second hard drive is configured as Slave. The master hard drive must have an active/bootable partition.

Excessively long formatting period.

If your hard drive takes an excessively long period of time to format, it is likely a cable connection problem. However, if your hard drive has a large capacity, it will take a longer time to format.

Serial Port

The serial device (modem, printer) doesn't output anything or is outputting garbled characters.

1. Make sure that the serial device's power is turned on and that the device is on-line.
2. Verify that the device is plugged into the correct serial port on the rear of the computer.
3. Verify that the attached serial device works by attaching it to a serial port that is working and configured correctly. If the serial device does not work, either the cable or the serial device has a problem. If the serial device works, the problem may be due to the onboard I/O or the address setting.
4. Make sure the COM settings and I/O address are configured correctly.

Keyboard

Nothing happens when a key on the keyboard was pressed.

1. Make sure the keyboard is properly connected.
2. Make sure there are no objects resting on the keyboard and that no keys are pressed during the booting process.

System Board

1. Make sure the add-in card is seated securely in the expansion slot. If the add-in card is loose, power off the system, re-install the card and power up the system.
2. Check the jumper settings to ensure that the jumpers are properly set.
3. Verify that all memory modules are seated securely into the memory sockets.
4. Make sure the memory modules are in the correct locations.
5. If the board fails to function, place the board on a flat surface and seat all socketed components. Gently press each component into the socket.
6. If you made changes to the BIOS settings, re-enter setup and load the BIOS defaults.

Appendix E - BIOS Status Code

Status Code Ranges

Status Code Range	Description
0x01 – 0x0F	SEC Status Codes & Errors
0x10 – 0x2F	PEI execution up to and including memory detection
0x30 – 0x4F	PEI execution after memory detection
0x50 – 0x5F	PEI errors
0x60 – 0xCF	DXE execution up to BDS
0xD0 – 0xDF	DXE errors
0xE0 – 0xE8	S3 Resume (PEI)
0xE9 – 0xEF	S3 Resume errors (PEI)
0xF0 – 0xF8	Recovery (PEI)
0xF9 – 0xFF	Recovery errors (PEI)

Standard Status Codes

SEC Status Codes

Status Code	Description
0x0	Not used
Progress Codes	
0x1	Power on. Reset type detection (soft/hard).
0x2	AP initialization before microcode loading
0x3	North Bridge initialization before microcode loading
0x4	South Bridge initialization before microcode loading
0x5	OEM initialization before microcode loading
0x6	Microcode loading
0x7	AP initialization after microcode loading
0x8	North Bridge initialization after microcode loading
0x9	South Bridge initialization after microcode loading
0xA	OEM initialization after microcode loading
0xB	Cache initialization
SEC Error Codes	
0xC – 0xD	Reserved for future AMI SEC error codes
0xE	Microcode not found
0xF	Microcode not loaded

PEI Status Codes

Status Code	Description
Progress Codes	
0x10	PEI Core is started
0x11	Pre-memory CPU initialization is started
0x12	Pre-memory CPU initialization (CPU module specific)
0x13	Pre-memory CPU initialization (CPU module specific)
0x14	Pre-memory CPU initialization (CPU module specific)
0x15	Pre-memory North Bridge initialization is started
0x16	Pre-Memory North Bridge initialization (North Bridge module specific)
0x17	Pre-Memory North Bridge initialization (North Bridge module specific)
0x18	Pre-Memory North Bridge initialization (North Bridge module specific)
0x19	Pre-memory South Bridge initialization is started
0x1A	Pre-memory South Bridge initialization (South Bridge module specific)
0x1B	Pre-memory South Bridge initialization (South Bridge module specific)
0x1C	Pre-memory South Bridge initialization (South Bridge module specific)
0x1D – 0x2A	OEM pre-memory initialization codes
0x2B	Memory initialization. Serial Presence Detect (SPD) data reading
0x2C	Memory initialization. Memory presence detection
0x2D	Memory initialization. Programming memory timing information
0x2E	Memory initialization. Configuring memory
0x2F	Memory initialization (other).
0x30	Reserved for ASL (see ASL Status Codes section below)
0x31	Memory Installed
0x32	CPU post-memory initialization is started
0x33	CPU post-memory initialization. Cache initialization
0x34	CPU post-memory initialization. Application Processor(s) (AP) initialization
0x35	CPU post-memory initialization. Boot Strap Processor (BSP) selection
0x36	CPU post-memory initialization. System Management Mode (SMM) initialization
0x37	Post-Memory North Bridge initialization is started
0x38	Post-Memory North Bridge initialization (North Bridge module specific)
0x39	Post-Memory North Bridge initialization (North Bridge module specific)

0x3A	Post-Memory North Bridge initialization (North Bridge module specific)
0x3B	Post-Memory South Bridge initialization is started
0x3C	Post-Memory South Bridge initialization (South Bridge module specific)
0x3D	Post-Memory South Bridge initialization (South Bridge module specific)
0x3E	Post-Memory South Bridge initialization (South Bridge module specific)
0x3F-0x4E	OEM post memory initialization codes
0x4F	DXE IPL is started
PEI Error Codes	
0x50	Memory initialization error. Invalid memory type or incompatible memory speed
0x51	Memory initialization error. SPD reading has failed
0x52	Memory initialization error. Invalid memory size or memory modules do not match.
0x53	Memory initialization error. No usable memory detected
0x54	Unspecified memory initialization error.
0x55	Memory not installed
0x56	Invalid CPU type or Speed
0x57	CPU mismatch
0x58	CPU self test failed or possible CPU cache error
0x59	CPU micro-code is not found or micro-code update is failed
0x5A	Internal CPU error
0x5B	reset PPI is not available
0x5C-0x5F	Reserved for future AMI error codes
S3 Resume Progress Codes	
0xE0	S3 Resume is started (S3 Resume PPI is called by the DXE IPL)
0xE1	S3 Boot Script execution
0xE2	Video repost
0xE3	OS S3 wake vector call
0xE4-0xE7	Reserved for future AMI progress codes
0xE0	S3 Resume is started (S3 Resume PPI is called by the DXE IPL)
S3 Resume Error Codes	
0xE8	S3 Resume Failed in PEI
0xE9	S3 Resume PPI not Found
0xEA	S3 Resume Boot Script Error
0xEB	S3 OS Wake Error
0xEC-0xEF	Reserved for future AMI error codes
Recovery Progress Codes	
0xF0	Recovery condition triggered by firmware (Auto recovery)
0xF1	Recovery condition triggered by user (Forced recovery)
0xF2	Recovery process started

0xF3	Recovery firmware image is found
0xF4	Recovery firmware image is loaded
0xF5-0xF7	Reserved for future AMI progress codes
Recovery Error Codes	
0xF8	Recovery PPI is not available
0xF9	Recovery capsule is not found
0xFA	Invalid recovery capsule
0xFB – 0xFF	Reserved for future AMI error codes

PEI Beep Codes

# of Beeps	Description
1	Memory not Installed
1	Memory was installed twice (InstallPeiMemory routine in PEI Core called twice)
2	Recovery started
3	DXE IPL was not found
3	DXE Core Firmware Volume was not found
7	Reset PPI is not available
4	Recovery failed
4	S3 Resume failed

DXE Status Codes

Status Code	Description
0x60	DXE Core is started
0x61	NVRAM initialization
0x62	Installation of the South Bridge Runtime Services
0x63	CPU DXE initialization is started
0x64	CPU DXE initialization (CPU module specific)
0x65	CPU DXE initialization (CPU module specific)
0x66	CPU DXE initialization (CPU module specific)
0x67	CPU DXE initialization (CPU module specific)
0x68	PCI host bridge initialization
0x69	North Bridge DXE initialization is started
0x6A	North Bridge DXE SMM initialization is started
0x6B	North Bridge DXE initialization (North Bridge module specific)
0x6C	North Bridge DXE initialization (North Bridge module specific)
0x6D	North Bridge DXE initialization (North Bridge module specific)
0x6E	North Bridge DXE initialization (North Bridge module specific)
0x6F	North Bridge DXE initialization (North Bridge module specific)

0x70	South Bridge DXE initialization is started
0x71	South Bridge DXE SMM initialization is started
0x72	South Bridge devices initialization
0x73	South Bridge DXE Initialization (South Bridge module specific)
0x74	South Bridge DXE Initialization (South Bridge module specific)
0x75	South Bridge DXE Initialization (South Bridge module specific)
0x76	South Bridge DXE Initialization (South Bridge module specific)
0x77	South Bridge DXE Initialization (South Bridge module specific)
0x78	ACPI module initialization
0x79	CSM initialization
0x7A – 0x7F	Reserved for future AMI DXE codes
0x80 – 0x8F	OEM DXE initialization codes
0x90	Boot Device Selection (BDS) phase is started
0x91	Driver connecting is started
0x92	PCI Bus initialization is started
0x93	PCI Bus Hot Plug Controller Initialization
0x94	PCI Bus Enumeration
0x95	PCI Bus Request Resources
0x96	PCI Bus Assign Resources
0x97	Console Output devices connect
0x98	Console input devices connect
0x99	Super IO Initialization
0x9A	USB initialization is started
0x9B	USB Reset
0x9C	USB Detect
0x9D	USB Enable
0x9E – 0x9F	Reserved for future AMI codes
0xA0	IDE initialization is started
0xA1	IDE Reset
0xA2	IDE Detect
0xA3	IDE Enable
0xA4	SCSI initialization is started
0xA5	SCSI Reset
0xA6	SCSI Detect
0xA7	SCSI Enable
0xA8	Setup Verifying Password
0xA9	Start of Setup
0xAA	Reserved for ASL (see ASL Status Codes section below)

0xAB	Setup Input Wait
0xAC	Reserved for ASL (see ASL Status Codes section below)
0xAD	Ready To Boot event
0xAE	Legacy Boot event
0xAF	Exit Boot Services event
0xB0	Runtime Set Virtual Address MAP Begin
0xB1	Runtime Set Virtual Address MAP End
0xB2	Legacy Option ROM Initialization
0xB3	System Reset
0xB4	USB hot plug
0xB5	PCI bus hot plug
0xB6	Clean-up of NVRAM
0xB7	Configuration Reset (reset of NVRAM settings)
0xB8 – 0xBF	Reserved for future AMI codes
0xC0 – 0xCF	OEM BDS initialization codes
DXE Error Codes	
0xD0	CPU initialization error
0xD1	North Bridge initialization error
0xD2	South Bridge initialization error
0xD3	Some of the Architectural Protocols are not available
0xD4	PCI resource allocation error. Out of Resources
0xD5	No Space for Legacy Option ROM
0xD6	No Console Output Devices are found
0xD7	No Console Input Devices are found
0xD8	Invalid password
0xD9	Error loading Boot Option (LoadImage returned error)
0xDA	Boot Option is failed (StartImage returned error)
0xDB	Flash update is failed
0xDC	Reset protocol is not available

DXE Beep Codes

# of Beeps	Description
4	Some of the Architectural Protocols are not available
5	No Console Output Devices are found
5	No Console Input Devices are found
1	Invalid password
6	Flash update is failed
7	Reset protocol is not available
8	Platform PCI resource requirements cannot be met

ACPI/ASL Status Codes

Status Code	Description
0x01	System is entering S1 sleep state
0x02	System is entering S2 sleep state
0x03	System is entering S3 sleep state
0x04	System is entering S4 sleep state
0x05	System is entering S5 sleep state
0x10	System is waking up from the S1 sleep state
0x20	System is waking up from the S2 sleep state
0x30	System is waking up from the S3 sleep state
0x40	System is waking up from the S4 sleep state
0xAC	System has transitioned into ACPI mode. Interrupt controller is in PIC mode.
0xAA	System has transitioned into ACPI mode. Interrupt controller is in APIC mode.

OEM-Reserved Status Code Ranges

Status Code	Description
0x5	OEM SEC initialization before microcode loading
0xA	OEM SEC initialization after microcode loading
0x1D – 0x2A	OEM pre-memory initialization codes
0x3F – 0x4E	OEM PEI post memory initialization codes
0x80 – 0x8F	OEM DXE initialization codes
0xC0 – 0xCF	OEM BDS initialization codes