

# KS070-AL

Atom



## Features

- 7" 800x480 TFT LCD panel with touch screen
- 1x CFast socket for storage
- IP65 front panel protection
- Dual displays: VGA + DP++
- Rich I/O: 2 LAN, 2 COM, 2 USB 3.0, 2 USB 2.0



## Panel

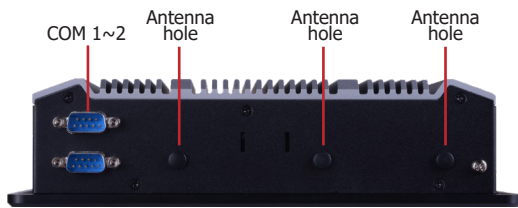

Top View

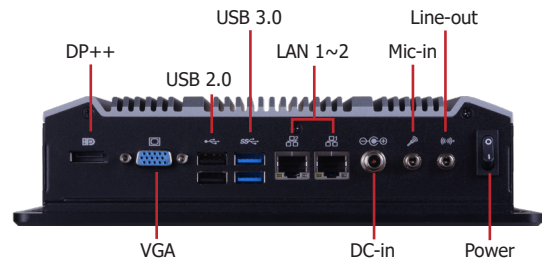

Bottom View

## Dimensions

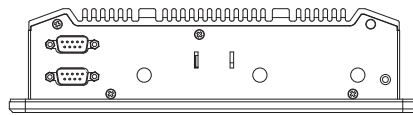

Top View

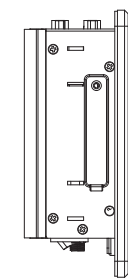

Left View

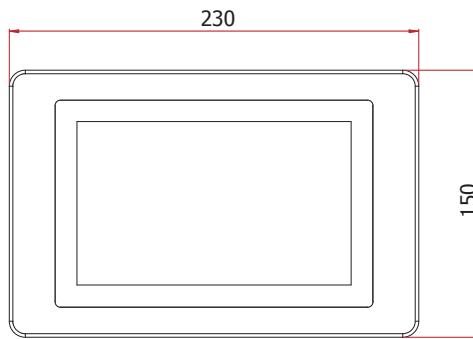

Front View

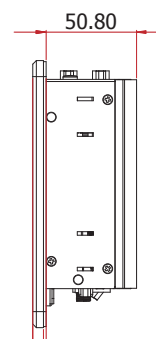

Right View

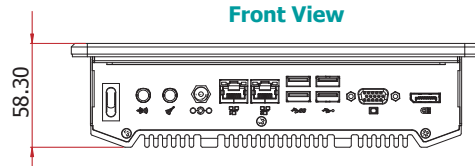

Bottom View

## ► Specifications

<b>SYSTEM</b>	<b>Processor</b>	Intel Atom® Processor E3900 Series, BGA 1296 Intel Atom® x5-E3940 Processor, Quad Core, 2M Cache, 1.6GHz (1.8GHz), 9.5W Intel® Celeron® Processor N3350, Dual Core, 2M Cache, 1.1GHz (2.4GHz), 6W
	<b>Memory</b>	One 204-pin SODIMM up to 8GB Single Channel DDR3L 1866MHz (4GB memory by default)
	<b>BIOS</b>	Insyde SPI 128Mbit (supports UEFI boot only)
<b>DISPLAY AND TOUCH SCREEN</b>	<b>Display</b>	7" 800x480 TFT LCD Panel with Capacitive/Resistive Touch Screen
	<b>Brightness</b>	500 cd/m <sup>2</sup>
	<b>Contrast</b>	400:1
	<b>Backlight Lifetime</b>	50,000 hours
<b>GRAPHICS</b>	<b>Controller</b>	Intel® HD Graphics
	<b>Feature</b>	OpenGL 4.2, Direct X 11.1, OpenCL 1.2, OGL ES 3.0 HW Decode: H.264, MPEG2, VC1, VP8, H.265, MPEG4 HW Encode: H.264, MPEG2, MPEG4
	<b>Display</b>	1 x VGA 1 x DP++ VGA: resolution up to 1920x1200 @ 60Hz DP++: resolution up to 4096x2160 @ 60Hz
	<b>Dual Displays</b>	VGA + DP++
<b>STORAGE</b>		1 x CFast Socket
<b>EXPANSION</b>	<b>Interface</b>	1 x Full-size Mini PCIe (USB/PCIe) 1 x M.2 2242 B-key (PCIe/USB 2.0/SATA 3.0)
<b>AUDIO</b>	<b>Audio Codec</b>	Realtek ALC262
<b>ETHERNET</b>	<b>Controller</b>	2 x Intel® I211AT PCIe (10/100/1000Mbps)
<b>TOP I/O</b>	<b>Serial</b>	2 x RS-232/422/485 (DB-9)
	<b>DIO</b>	1 x 8-bit DIO (DB-9) (available upon request)
	<b>Buttons</b>	1 x Power Button
	<b>Wi-Fi Antenna</b>	3 x Wi-Fi Module Antenna Hole
<b>BOTTOM I/O</b>	<b>Ethernet</b>	2 x GbE (RJ-45) (10/100/1000Mbps)
	<b>USB</b>	2 x USB 3.0 (type A) 2 x USB 2.0 (type A)
	<b>Display</b>	1 x VGA 1 x DP++
	<b>Audio</b>	1 x Line-out 1 x Mic-in
<b>WATCHDOG TIMER</b>	<b>Output &amp; Interval</b>	System Reset, Programmable via Software from 1 to 255 Seconds
<b>POWER</b>	<b>Type</b>	12V DC
	<b>Connector</b>	DC Jack
<b>OS SUPPORT (UEFI ONLY)</b>		Windows 10 IoT Enterprise 64-bit
<b>MECHANISM</b>	<b>Construction</b>	Sheet Metal
	<b>IP Rating</b>	IP65 Front Panel Protection
	<b>Mounting</b>	Panel/VESA Mount
	<b>Dimensions (W x H x D)</b>	230mm x 150mm x 58.3mm
	<b>Weight</b>	1.5kg
<b>ENVIRONMENT</b>	<b>Operating Temperature</b>	-20 to 55°C
	<b>Storage Temperature</b>	-30 to 80°C
	<b>Relative Humidity</b>	5 to 85% RH (non-condensing)
<b>STANDARDS AND CERTIFICATIONS</b>	<b>Shock</b>	OP: Half-sine, 3G @ 11ms Non-OP: Half-sine, 5G @ 11ms
		OP: Random, 1Grms @ 5~500Hz, 30min Non-OP: Sweep sine, 3Grms @ 10~500Hz, 30min
	<b>Vibration</b>	
	<b>Certifications</b>	TBD

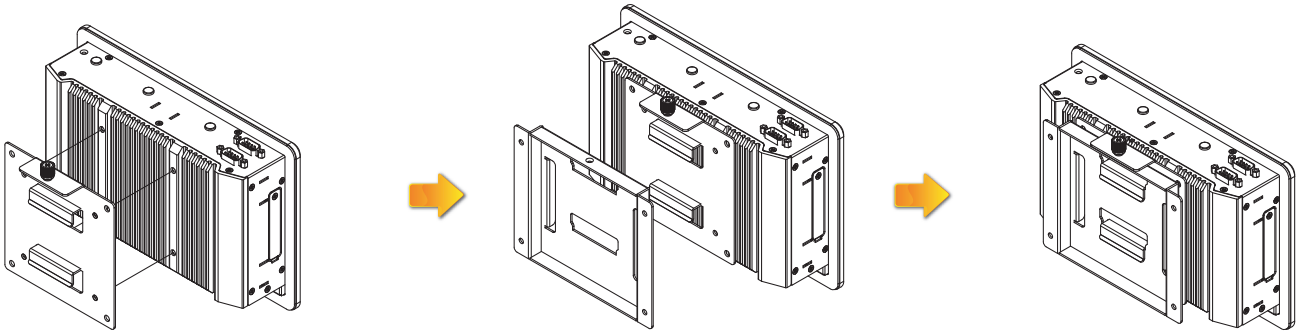
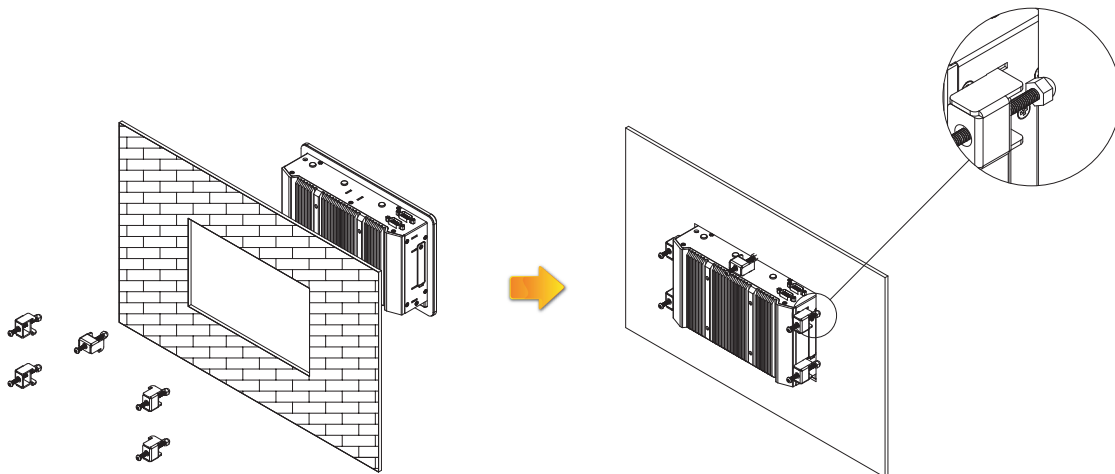
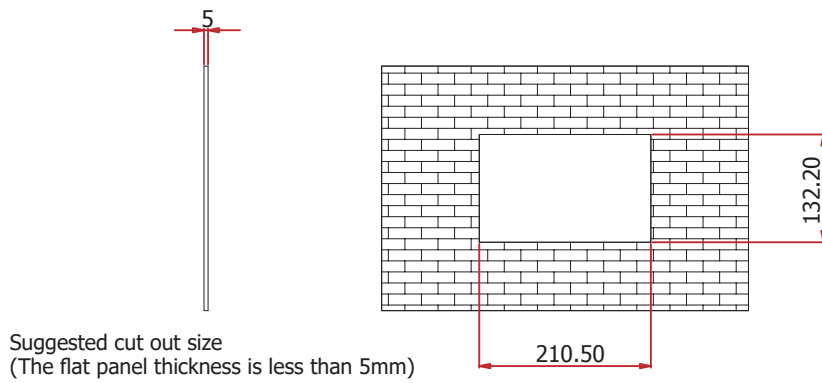
**▶ VESA Mounting****▶ Panel Mounting**

### ► Ordering Information

Model Name	Part Number	Description
<b>KS070-ALE39P</b>	750-KS070A-000G	7" Panel PC, Intel Atom® x5-E3940, 4GB Memory, Capacitive Touch
<b>KS070-ALN33P</b>	750-KS070A-100G	7" Panel PC, Intel® Celeron® Processor N3350, 4GB Memory, Capacitive Touch
<b>KS070-ALN33R</b>	750-KS070A-200G	7" Panel PC, Intel® Celeron® Processor N3350, 4GB Memory, Resistive Touch

### ► Optional Items

Optional Items	Part Number	Description
<b>Wi-Fi</b>	761-AP1235-000G	Wi-Fi kit, RoHS
<b>Power Cord</b>	785-PWRD	Power cord, Standards (USA/EUR/CH), 1.8m, RoHS
<b>Power Adapter</b>	671-106012-000G	60W, 12V/5A, Level 6, RoHS
<b>Panel Mount</b>	761-KS2020-000G	7" Panel PC Panel Mount Kit, RoHS

785-XXX is a group number instead of a unique part number. Please contact your regional sales representative if you need more information.

### ► Packing List

• 1 KS070-AL Touch Panel PC
• 1 Poron foam
• 1 Chassis Panel Mount Bracket
• 1 Quick Installation Guide
• 1 CD disk includes:
- Manual