



EC531/532-KH

User's Manual



Copyright

This publication contains information that is protected by copyright. No part of it may be reproduced in any form or by any means or used to make any transformation/adaptation without the prior written permission from the copyright holders.

This publication is provided for informational purposes only. The manufacturer makes no representations or warranties with respect to the contents or use of this manual and specifically disclaims any express or implied warranties of merchantability or fitness for any particular purpose. The user will assume the entire risk of the use or the results of the use of this document. Further, the manufacturer reserves the right to revise this publication and make changes to its contents at any time, without obligation to notify any person or entity of such revisions or changes.

Changes after the publication's first release will be based on the product's revision. The website will always provide the most updated information.

© 2019. All Rights Reserved.

Trademarks

Product names or trademarks appearing in this manual are for identification purpose only and are the properties of the respective owners.

FCC and DOC Statement on Class A

This equipment has been tested and found to comply with the limits for a Class A digital device, pursuant to Part 15 of the FCC rules. These limits are designed to provide reasonable protection against harmful interference when the equipment is operated in a residential installation. This equipment generates, uses and can radiate radio frequency energy and, if not installed and used in accordance with the instruction manual, may cause harmful interference to radio communications. However, there is no guarantee that interference will not occur in a particular installation. If this equipment does cause harmful interference to radio or television reception, which can be determined by turning the equipment off and on, the user is encouraged to try to correct the interference by one or more of the following measures:

- Reorient or relocate the receiving antenna.
- Increase the separation between the equipment and the receiver.
- Connect the equipment into an outlet on a circuit different from that to which the receiver is connected.
- Consult the dealer or an experienced radio TV technician for help.

Notice:

1. The changes or modifications not expressly approved by the party responsible for compliance could void the user's authority to operate the equipment.
2. Shielded interface cables must be used in order to comply with the emission limits.

Copyright.....	2
Trademarks.....	2
FCC and DOC Statement on Class A	2
About this Manual.....	4
Static Electricity Precautions	4
Safety Measures.....	4
Safety Precautions	5
About the Package.....	5
Chapter 1 - Introduction.....	6
Overview.....	6
Key Features	6
Specifications.....	7
Getting to Know the EC531/EC532-KH.....	8
Mechanical Dimensions	9
Chapter 2 - Getting Started.....	10
Chapter 3 - Installing the Devices.....	11
Expansion Slots Sequence	12
Removing the Chassis Cover.....	13
Installing a SODIMM	13
Installing a Mini PCIe Card.....	14
Chapter 4 - Jumper Settings.....	16
Clear CMOS Data.....	16
PS/2 KB/MS Power Select.....	16
COM1/COM2 RS232 Power Select	17
DIO Power Source Select (Pins 0~7)	17
COM1/COM2 RS232/422/485 Select.....	18
COM3/COM4 RS232/422/485 Select.....	19
DIO High/Low Select (DIO 0~3).....	20

DIO High/Low Select (DIO 4~7).....	20
COM6 /COM7 /COM8 RS232/422/485 Select (daughter board) 21	
COM6/COM7 RS232 Power Select (daughter board)	22
Chapter 5 - Ports and Connectors.....	23
Front Panel I/O Ports.....	23
Rear Panel I/O Ports	23
USB Ports (mainboard)	24
USB Ports (daughter board)	24
RJ45 LAN Ports.....	25
Display Interfaces.....	25
COM (Serial) Ports	26
COM (Serial) Ports (daughter board)	26
9~36V DC-in	27
Rear Audio Connector.....	27
SATA (Serial ATA) & Power Connectors	28
SMBus Connector	28
Digital I/O Connector & DIO Power (mainboard).....	29
Digital I/O Connector (daughter board)	29
Front Panel Connector	30
12V DC-out	30
Expansion Slots	31
PS/2 KB/MS Connector.....	32
LPC Connector.....	33
Chapter 6 - Mounting Options	34

About this Manual

An electronic file of this manual can be obtained from the DFI website at www.dfi.com. To download the user's manual from our website, please go to "Support" > "Download Center." On the Download Center page, select your product or type the model name and click "Search" to find all technical documents including the user's manual for a specific product.

Warranty

1. Warranty does not cover damages or failures that arised from misuse of the product, inability to use the product, unauthorized replacement or alteration of components and product specifications.
2. The warranty is void if the product has been subjected to physical abuse, improper installation, modification, accidents or unauthorized repair of the product.
3. Unless otherwise instructed in this user's manual, the user may not, under any circumstances, attempt to perform service, adjustments or repairs on the product, whether in or out of warranty. It must be returned to the purchase point, factory or authorized service agency for all such work.
4. We will not be liable for any indirect, special, incidental or damages to the product that has been modified or altered.

Static Electricity Precautions

It is quite easy to inadvertently damage your PC, system board, components or devices even before installing them in your system unit. Static electrical discharge can damage computer components without causing any signs of physical damage. You must take extra care in handling them to ensure against electrostatic build-up.

1. To prevent electrostatic build-up, leave the system board in its anti-static bag until you are ready to install it.
2. Wear an antistatic wrist strap.
3. Do all preparation work on a static-free surface.
4. Hold the device only by its edges. Be careful not to touch any of the components, contacts or connections.
5. Avoid touching the pins or contacts on all modules and connectors. Hold modules or connectors by their ends.



Important:

Electrostatic discharge (ESD) can damage your processor, disk drive and other components. Perform the upgrade instruction procedures described at an ESD workstation only. If such a station is not available, you can provide some ESD protection by wearing an antistatic wrist strap and attaching it to a metal part of the system chassis. If a wrist strap is unavailable, establish and maintain contact with the system chassis throughout any procedures requiring ESD protection.

Safety Measures

To avoid damage to the system:

- Use the correct AC input voltage range.

To reduce the risk of electric shock:

- Unplug the power cord before removing the system chassis cover for installation or servicing. After installation or servicing, cover the system chassis before plugging the power cord.

Battery:

- Danger of explosion if battery incorrectly replaced.
- Replace only with the same or equivalent type recommend by the manufacturer.
- Dispose of used batteries according to local ordinance.

Safety Precautions

- Use the correct DC input voltage range.
- Unplug the power cord before removing the system chassis cover for installation or servicing. After installation or servicing, cover the system chassis before plugging the power cord.
- Danger of explosion if battery incorrectly replaced.
- Replace only with the same or equivalent type recommend by the manufacturer.
- Dispose of used batteries according to local ordinance.
- Keep this system away from humidity.
- Place the system on a stable surface. Dropping it or letting it fall may cause damage.
- The openings on the system are for air ventilation to protect the system from overheating. **DO NOT COVER THE OPENINGS.**
- Place the power cord in such a way that it will not be stepped on. Do not place anything on top of the power cord. Use a power cord that has been approved for use with the system and that it matches the voltage and current marked on the system's electrical range label.
- If the system will not be used for a long time, disconnect it from the power source to avoid damage by transient overvoltage.
- If one of the following occurs, consult a service personnel:
 - The power cord or plug is damaged.
 - Liquid has penetrated the system.
 - The system has been exposed to moisture.
 - The system is not working properly.
 - The system dropped or is damaged.
 - The system has obvious signs of breakage.
- The unit uses a three-wire ground cable which is equipped with a third pin to ground the unit and prevent electric shock. Do not defeat the purpose of this pin. If your outlet does not support this kind of plug, contact your electrician to replace the outlet.
- Disconnect the system from the DC outlet before cleaning. Use a damp cloth. Do not use liquid or spray detergents for cleaning.

About the Package

The package contains the following items. If any of these items are missing or damaged, please contact your dealer or sales representative for assistance.

- 1 EC531/EC532-KH system unit
- 1 CD disk includes: Drivers/Manual

Optional Items

- Wall Mount kit
- Power Cord
- Power Adapter (100W/120W/160W)

The board and accessories in the package may not come similar to the information listed above. This may differ in accordance to the sales region or models in which it was sold. For more information about the standard package in your region, please contact your dealer or sales representative.

Chapter 1 - Introduction

Overview



Front View



Rear View

Key Features

Model Name	EC531/EC532-KH
Processor	7th Generation Intel® Core™ processors
Chipset	Intel® CM238 or Intel® QM175 Chipset
LAN	2 LAN ports
COM	8 COM ports
Display	VGA DVI-D (DVI-I connector) ⁽¹⁾ HDMI or DP ⁽²⁾
USB	8 USB 3.0 + 2 USB 2.0 Type A ports
Power	9~36V DC-in



Notes:

1. This port can be in HDMI or DVI-D (DVI-D available upon request).
2. This port is a DP/HDMI combo port but can only transmit either HDMI or DP signals (as indicated on the panel). Please plug in a DP or an HDMI cable with the right orientation and alignment to avoid damage to the connector. You should feel resistance (due to a pin on the right) if the cable is not inserted correctly. For detailed instructions, see <https://youtu.be/SUj07rfN518>.

Specifications

Processor System	7th Generation Intel® Core™ Processors, BGA 1440 Intel® Xeon® Processor E3-1535M v6, Quad Core, 8M Cache, 3.1GHz (4.2GHz), 45W Intel® Core™ i7-7820EQ Processor, Quad Core, 8M Cache, 3.0GHz (3.7GHz), 45W Intel® Core™ i5-7440EQ Processor, Quad Core, 6M Cache, 2.9GHz (3.6GHz), 45W Intel® Core™ i5-7442EQ Processor, Quad Core, 6M Cache, 2.1GHz (2.9GHz), 25W Intel® Core™ i3-7100E Processor, Dual Core, 3M Cache, 2.9GHz, 35W Intel® Core™ i3-7102E Processor, Dual Core, 3M Cache, 2.1GHz, 25W
Chipset	<ul style="list-style-type: none"> Intel® CM238 Chipset or Intel® QM175 Chipset
Memory	Two 260-pin SODIMM <ul style="list-style-type: none"> Supports dual-channel DDR4 2400MHZ Supports up to 32GB system memory Intel® CM238 supports ECC
Graphics	Intel® HD Graphics OpenGL 5.0, DirectX 11, OpenCL 2.1 <ul style="list-style-type: none"> Supports these codecs: HW Decode: HEVC/H.265, H.264, M/JPEG, MPEG2, VC1/WMV9, VP8 (8-bit), VP9 (10-bit) HW Encode: HEVC/H.265, M/JPEG, MPEG2, VP8 Output displays: VGA: resolution up to 1920x1200 @ 60Hz DVI-I: resolution up to 1920x1200 @ 60Hz HDMI: resolution up to 4096x2160 @ 24Hz DP: resolution up to 4096x2304 @ 60Hz
Triple/Dual Display	VGA (+) DVI-D (DVI-I connector) or HDMI (+) HDMI or DP
Storage	<ul style="list-style-type: none"> Two 2.5" SATA Drive Bay (support only HDD or SSD with 7mm thickness) SATA 3.0 port with data transfer rate up to 6Gb/s
Ethernet	<ul style="list-style-type: none"> One Intel® I211IT PCIe (10/100/1000Mbps) One Intel® I219LM with iAMT11.0 PCIe (10/100/1000Mbps) (only Intel® Xeon® and Core™ i7/i5 support iAMT)
Expansion	1 x PCIe x16 + 2 x PCI (EC531-KH only) or 2 x PCIe x16 (x1 and x8 signal) + 1 x PCI (EC532-KH only) 1 x M.2 2280 M key (PCIe x4 NVMe, Intel® Optane™ memory support) One full-size/half-size Mini PCIe with mini SIM socket (PCIe & USB) One full-size/half-size Mini PCIe with mini SIM socket (USB)



Note:

Please contact your sales representative for more information on the mounting kit, which is not included in the standard model.

I/O Ports	Front: <ul style="list-style-type: none"> Two RS-232/422/485 (DB-9) Two USB 2.0 ports One status and HDD LED One power button with LED One reset button One remote switch Three antenna holes Rear: <ul style="list-style-type: none"> One VGA port & DVI-D (DVI-I connector) & one HDMI Eight USB 3.0 Type A ports One Line-out and Mic-in Ports Six RS-232/422/485 (DB-9) (RS-232 with power) Two GbE ports (RJ-45) One 8-bit DIO One 9~36V DC-in 3-pole terminal block
Power	<ul style="list-style-type: none"> Power input voltage: 9~36V DC-in (terminal block connector)
Cooling System	<ul style="list-style-type: none"> Fanless with heatsink
Environment	<ul style="list-style-type: none"> Operating Temperature: <ul style="list-style-type: none"> - 0 to 50°C (HDD) - 20 to 60°C (SSD) - 40 to 70°C (optional) Storage Temperature: <ul style="list-style-type: none"> -20 to 85°C Relative Humidity: <ul style="list-style-type: none"> 5 to 95% RH (non-condensing) Shock: <ul style="list-style-type: none"> Half sine wave 3G, 11ms, 3 shock per axis Vibration: <ul style="list-style-type: none"> IEC68-2-64
Construction	<ul style="list-style-type: none"> Metal + Aluminum
Mounting	<ul style="list-style-type: none"> Wall mount - Mounting brackets and screws* (optional)
Dimensions	<ul style="list-style-type: none"> 235mm x 153.8mm x 222mm (W x H x D)
Weight	<ul style="list-style-type: none"> 4.8 kg
BIOS	Insyde SPI 128Mbit
OS Support	<ul style="list-style-type: none"> Windows 10 IoT Enterprise 64 Bit Linux (available upon request)
Other Features	System Reset, Programmable via Software from 1 to 255 Seconds
Standards and Certifications	Vibration: IEC68-2-64 Certificates: CE, FCC Class A, Microsoft Azure

Getting to Know the EC531/EC532-KH

Front View

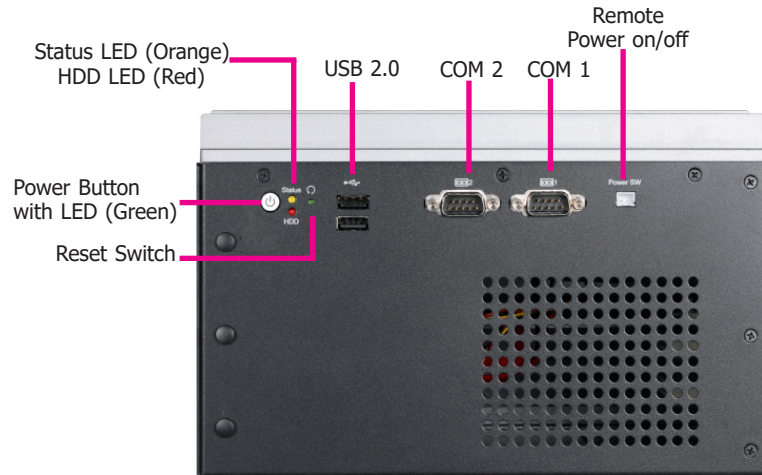

Rear View

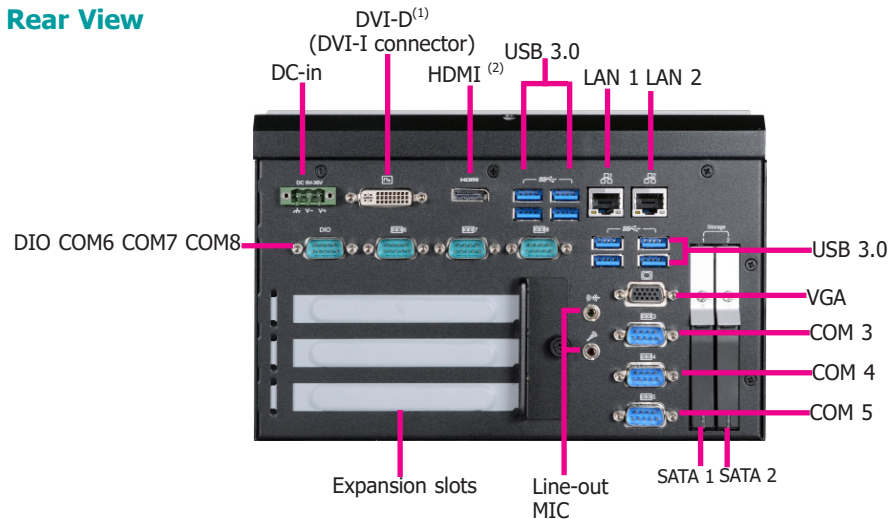

Notes:

1. This port can be in HDMI or DVI-D (DVI-D available upon request).
2. This port is a DP/HDMI combo port but can only transmit either HDMI or DP signals (as indicated on the panel). Please plug in a DP or an HDMI cable with the right orientation and alignment to avoid damage to the connector. You should feel resistance (due to a pin on the right) if the cable is not inserted correctly. For detailed instructions, see <https://youtu.be/SUj07rfN518>.

Front I/O Ports

Power Button with LED (Green)

Press to power on or power off the system.

Reset Button

Press to reset the system.

HDD LED (Red)

Indicates the status of disk drives.

HDD LED		
HDD State	Disk access activity	Disk drives present or not present
LED Behavior	Blink	Off

Status LED (Orange)

Indicates system status as below.

Status LED				
Suspend Mode	S0	S1	S3	S4, S5
LED Behavior	Always ON	Quick Blink (cycle 1 sec)	Slow Blink (cycle >1 sec)	Off

SATA 1 /SATA 2

Install SATA drives into the system.

Remote Power-on/Power-off Switch Connector

Connects distant power on/off switch.

USB 3.0 Ports

Connect to USB 3.0 as well as devices based on previous USB versions.

COM and DIO Ports

All COM1~COM4 and COM6~COM8 can be selected among RS232, RS422 and RS485.

In addition, COM1~COM2 and COM6~COM7 can be selected between RS232 and RS232 with power via jumper settings.

The DIO port provides 8-bit digital input/output.

DVI-D (DVI-I connector) / HDMI / VGA Connector

Connects the DVI / HDMI / VGA connector of an LCD monitor.

Line-out and Microphone Ports

Connect audio devices such as microphones and speakers.

Gigabit LAN Ports

Connect the system to a local area network.

DC-in

DC 9~36V power input via a terminal block connector.

PCIe Expansion Slots

Provide PCIe and PCI expansion via a riser card.

Mechanical Dimensions

Chassis Dimensions

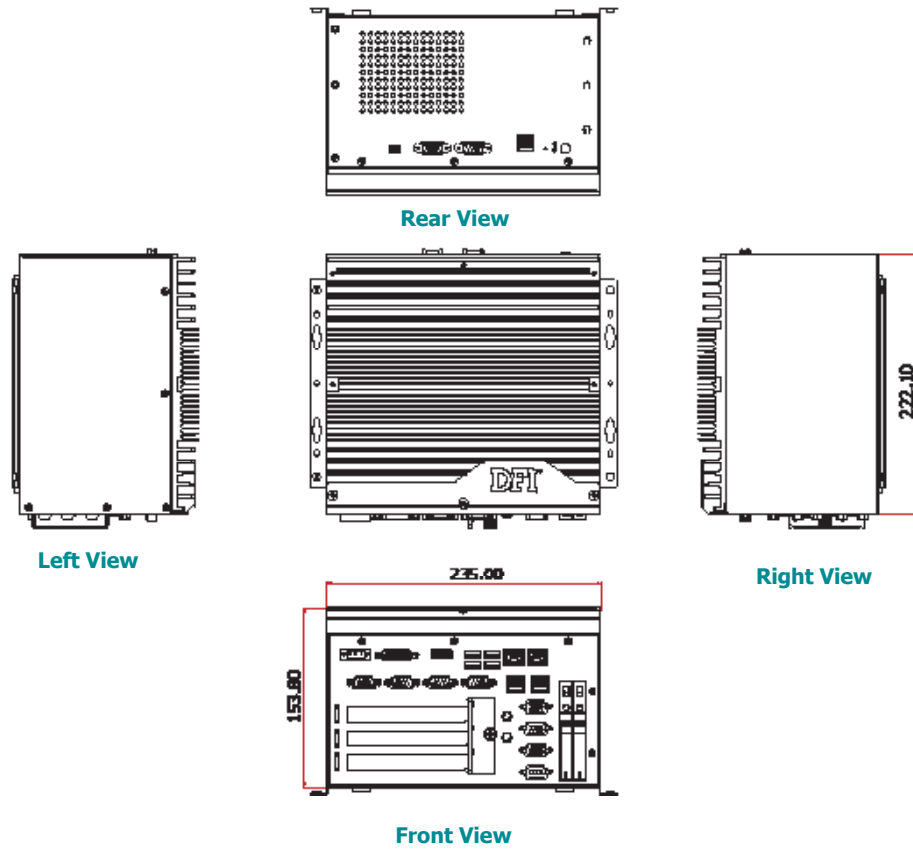

Motherboard Dimensions

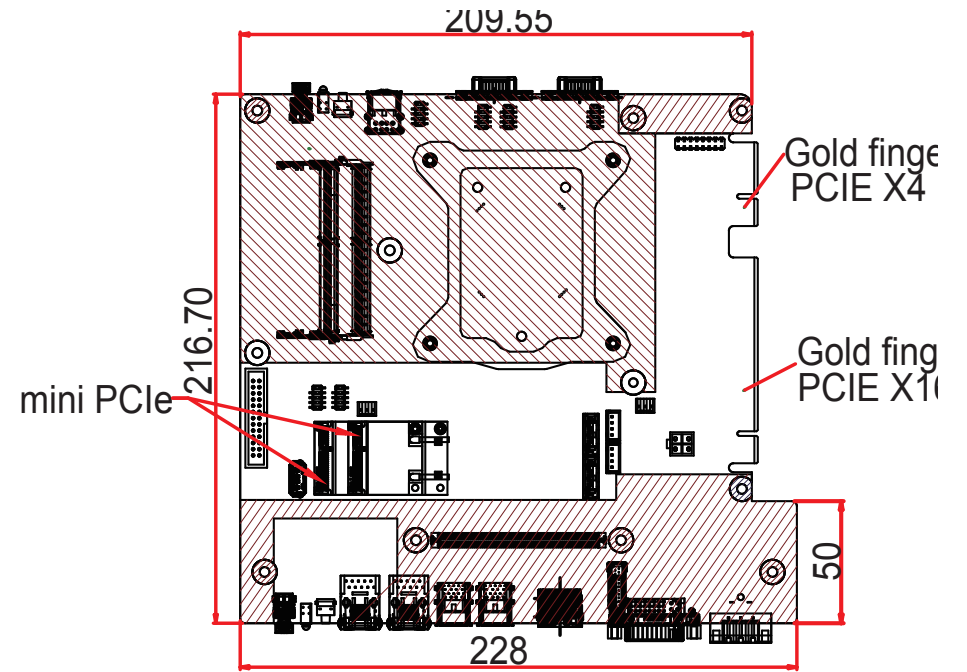

Chapter 2 - Getting Started

Preparing the System

Before you start using the system, you need the following items:

- SATA hard drive
- AC power adapter
- Optical drive (for installing software/drivers)
- Memory module

Installing Devices

The following devices can be installed in the system.

- Memory modules
- SATA hard drives
- Mini PCIe cards
- PCIe and PCI expansion cards

Configuring the BIOS

To get you started, you may need to change configurations such as the date, time and the type of hard disk drive.

1. Power-on the system.
2. After the memory test, the message "Press DEL to run setup" will appear on the screen. Press the Delete key to enter the BIOS setup utility.

Installing an Operating System

To install an OS, you need an optical drive or a USB flash drive and boot from such a device.

Make sure a 2.5" SATA drive is already installed.

1. Refer to the following chapters for information on installing a SATA drive.
2. Refer to your operating system manual for instructions on installing an operating system.

Installing the Drivers

The system requires you to install drivers for some devices to operate properly. Refer to the Supported Software chapter for instructions on installing the drivers.

Chapter 3 - Installing the Devices

The SATA drive bay can be easily accessed without opening the system. However, the system does not support hot-swapping hard drives; turn off the system first.

Use the following procedure to install a SATA HDD or SSD to the system:

1. Locate the drive bay on the front panel and open it by releasing the handle.



SATA drive bay
SATA 1 SATA 2

2. Slide the HDD into the drive bay. Note that the HDD should be positioned vertically with the SATA power connector on top of the data connector to correctly engage with the system's SATA connectors. Then close the drive bay and lock the handle.



Notes:

1. The slot is designed to exactly fit a 2.5" SATA drive with 7mm thickness; it cannot fit SATA drives with other sizes.
2. Do not force to close the drive bay if the HDD is not correctly inserted.

Expansion Slots Sequence

EC531-KH

Below figure shows the expansion slots of PCIe, PCI, PCI (from top to bottom)

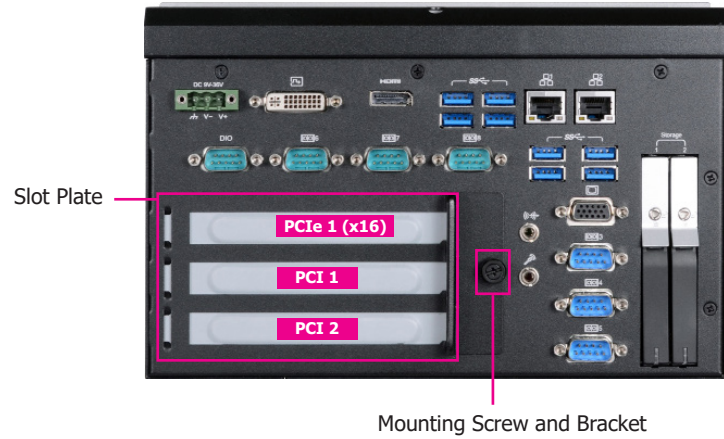

EC532-KH

Below figure shows the expansion slots of PCIe, PCI, PCI (from top to bottom)

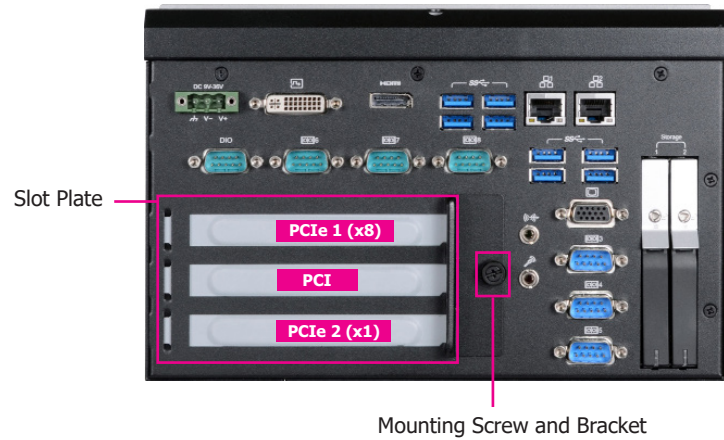

Removing the Chassis Cover

Before working inside your system, observe the following precautions:

1. Make sure the system and all other peripherals connected to it have been powered off.
2. Disconnect all power cords and cables.
3. The 4 mounting screws on the bottom of the system are used to secure the cover to the chassis. Remove these screws and put them in a safe place for later use.

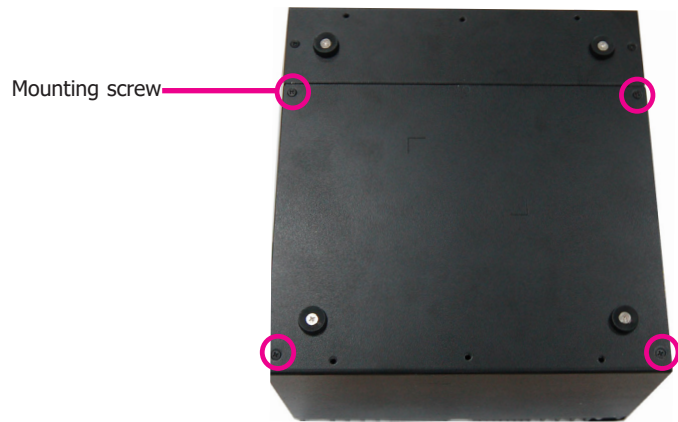

4. Lift the cover upward to open the system.



Installing a SODIMM

The SODIMM sockets are located on the system board and under the supporting bracket. You can access the sockets by working in the small space between the bracket and the system board.

The SODIMM sockets are under the supporting bracket.

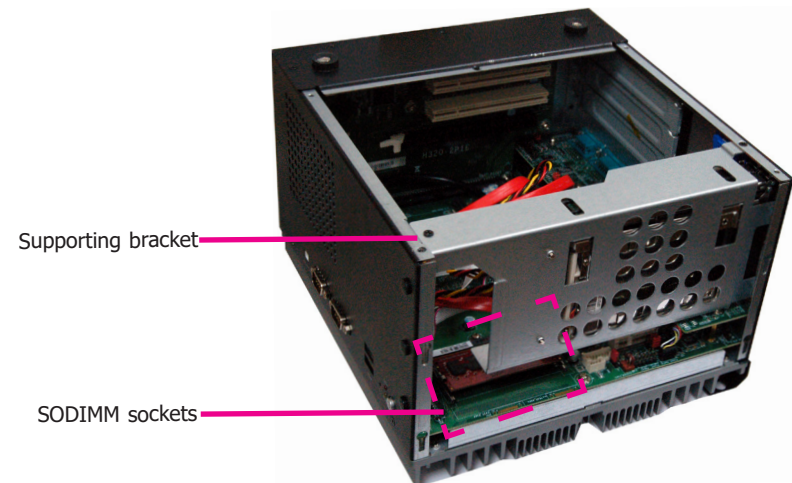

To install a SODIMM module, grasp the module by its edges and align the module's notch with the socket's notch; then insert the module into the socket at an angle and push it down until you feel a click.

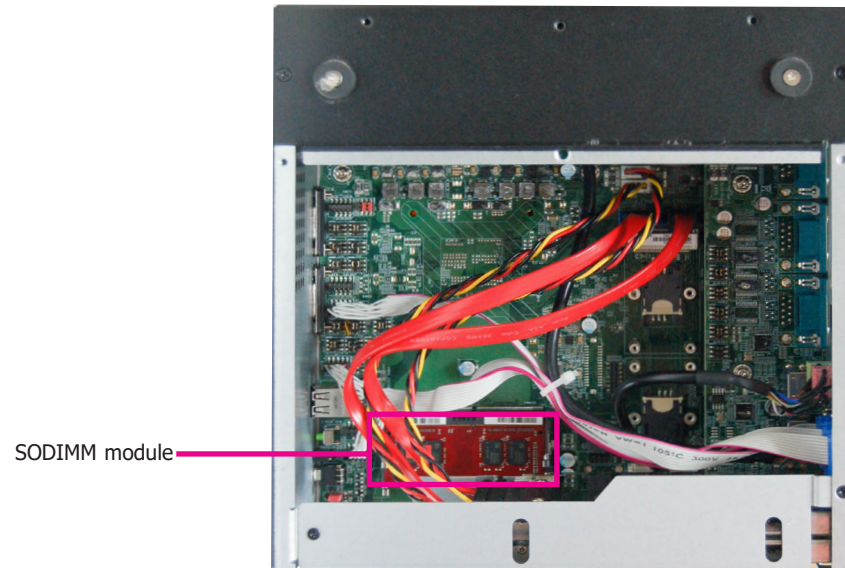

Notes:

1. The system supports dual-channel configuration. To enable dual-channel, populate both SODIMM sockets.
2. The SODIMM sockets can only accept DDR4 memory modules (Skus with Intel® CM238 chipset support ECC). Please do not install other types of memory modules.

Installing a Mini PCIe Card

The system board is equipped with 2 Mini PCIe slots with Mini SIM card sockets to support a variety of wireless LAN and mobile broadband communication modules. Mini PCIe slot 1 provides both USB and PCIe interfaces whereas Mini PCIe slot 2 provides only USB interface.

1. Grasp the Mini PCIe card by its edges and align the notch in the connector of the Mini PCIe card with the notch in the connector on the system board.

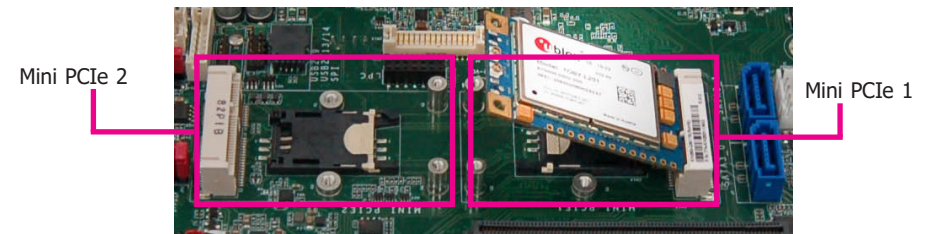

2. Push down the other end of the card and secure it on the board with the provided mounting screws.



Installing a SIM Card

Open the SIM card socket by pushing the white latch inward.

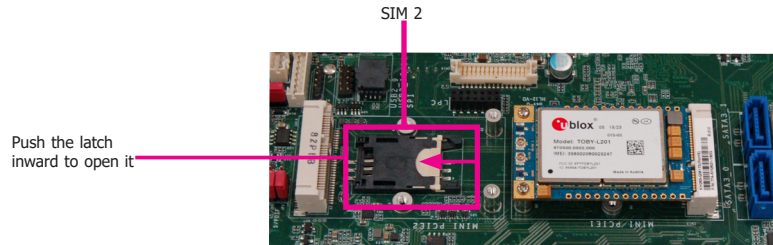

Insert the SIM card into the slot. Please place the card with the IC facing down and the angled corner aligning with the socket's angled corner so it will be correctly in contact with the system board.

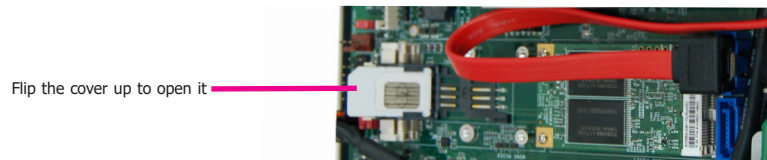

Close the slot's cover and lock the slot by pushing the white latch outward.

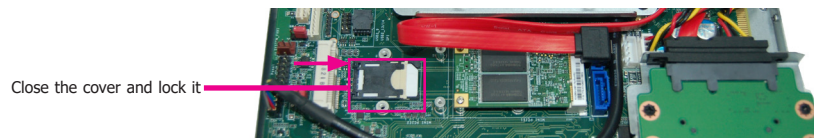

Installing an M.2 Card

The onboard M.2 Type 2280 connector (M Key) supports PCIe NVMe modules up to PCIe Gen 3.0 x4 bandwidth. Note that only SKUs with Intel® QM175 Chipset support M.2 socket.

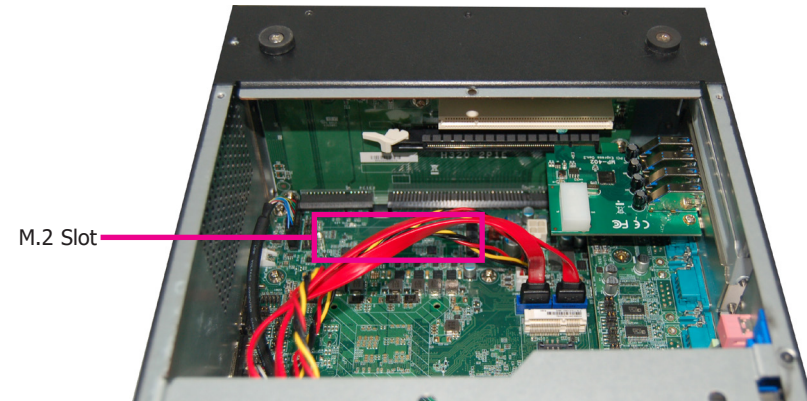

To install an M.2 card, insert the bottom edge of the M.2 card into the connector, and then secure the card to the standoff with the provided mounting screw.



Chapter 4 - Jumper Settings

Clear CMOS Data

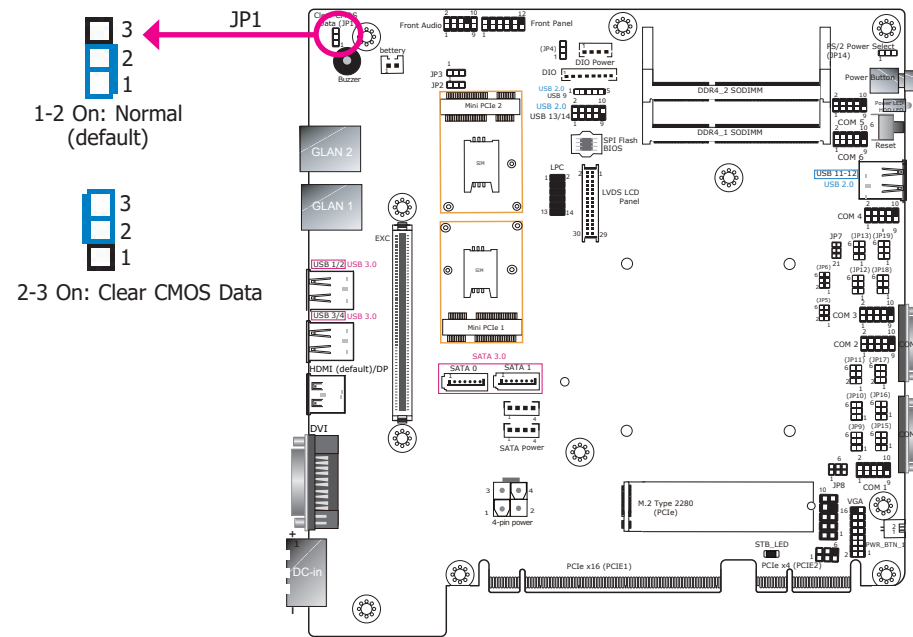

If you encounter the following conditions, you can reconfigure the system with the default values stored in the ROM BIOS.

- a) CMOS data becomes corrupted.
- b) You forgot the supervisor or user password.

To load the default values stored in the ROM BIOS, please follow these steps below:

1. Power-off the system and unplug the power cord.
2. Set the jumper pins 2 and 3 to On. Wait for a few seconds and set jumper back to its default setting, pins 1 and 2 On.
3. Now plug the power cord and power on the system.

PS/2 KB/MS Power Select

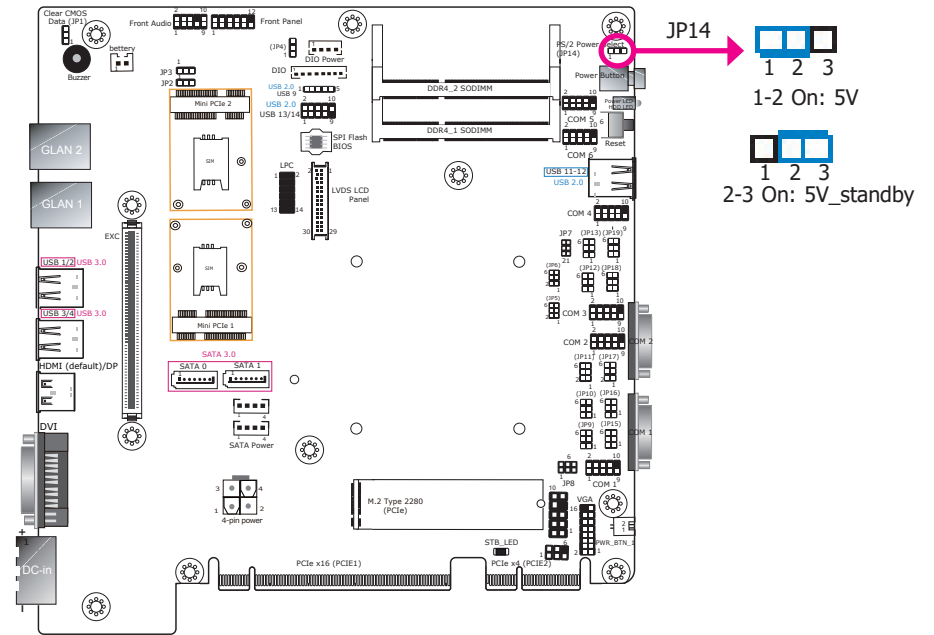

JP14 is used to select power for the PS/2 KB/MS connector (J20). Please refer to Chapter 5 for detailed information on connectors.

Selecting +5V_standby will allow you to use PS/2 devices to wake up the system.

COM1/COM2 RS232 Power Select

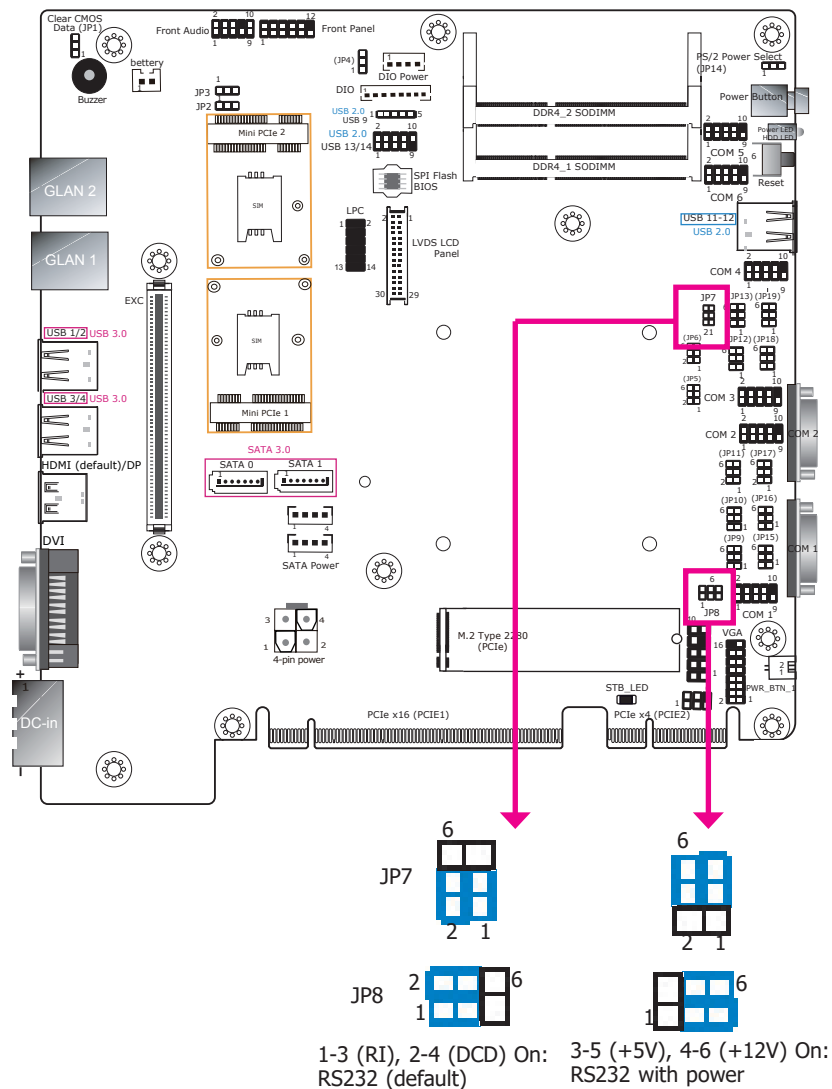

JP8 (for COM1) and JP7 (for COM2) are used to configure Serial COM ports to pure RS232 or RS232 with power. The pin functions (Pin 1 and Pin 9) of COM1 and COM2 will vary according to JP8's and JP7's setting respectively.

DIO Power Source Select (Pins 0~7)

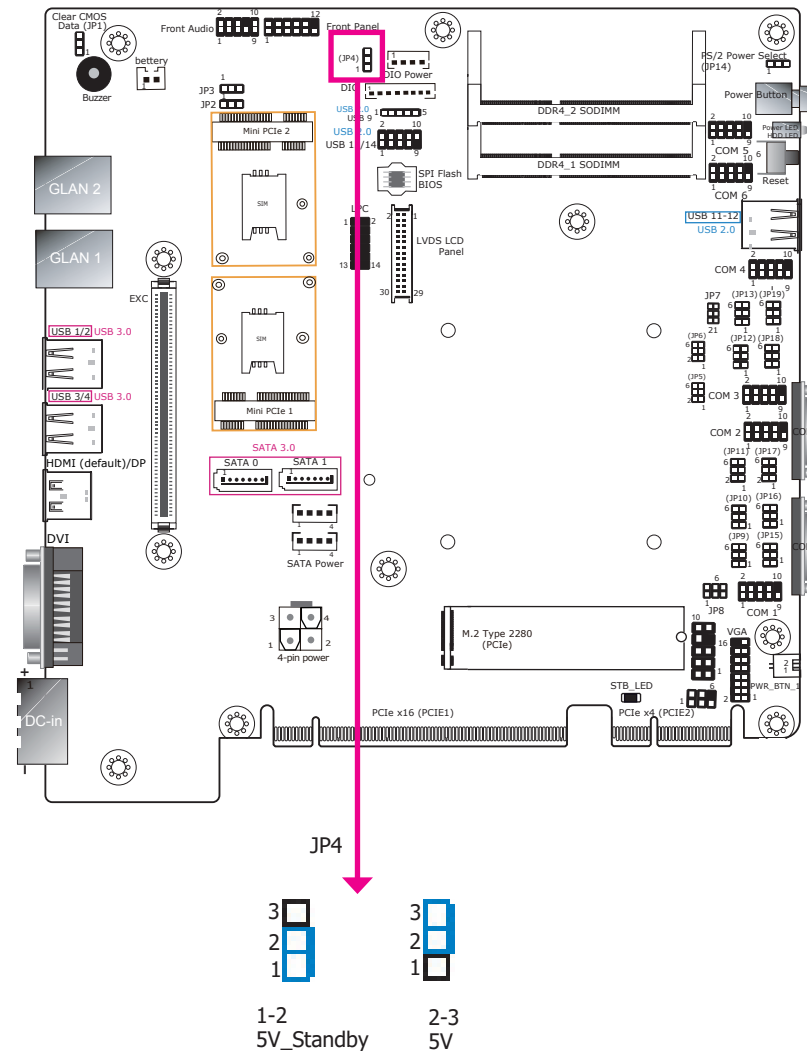

JP4 is used to configure the power of the DIO pins 0~7.

COM1/COM2 RS232/422/485 Select

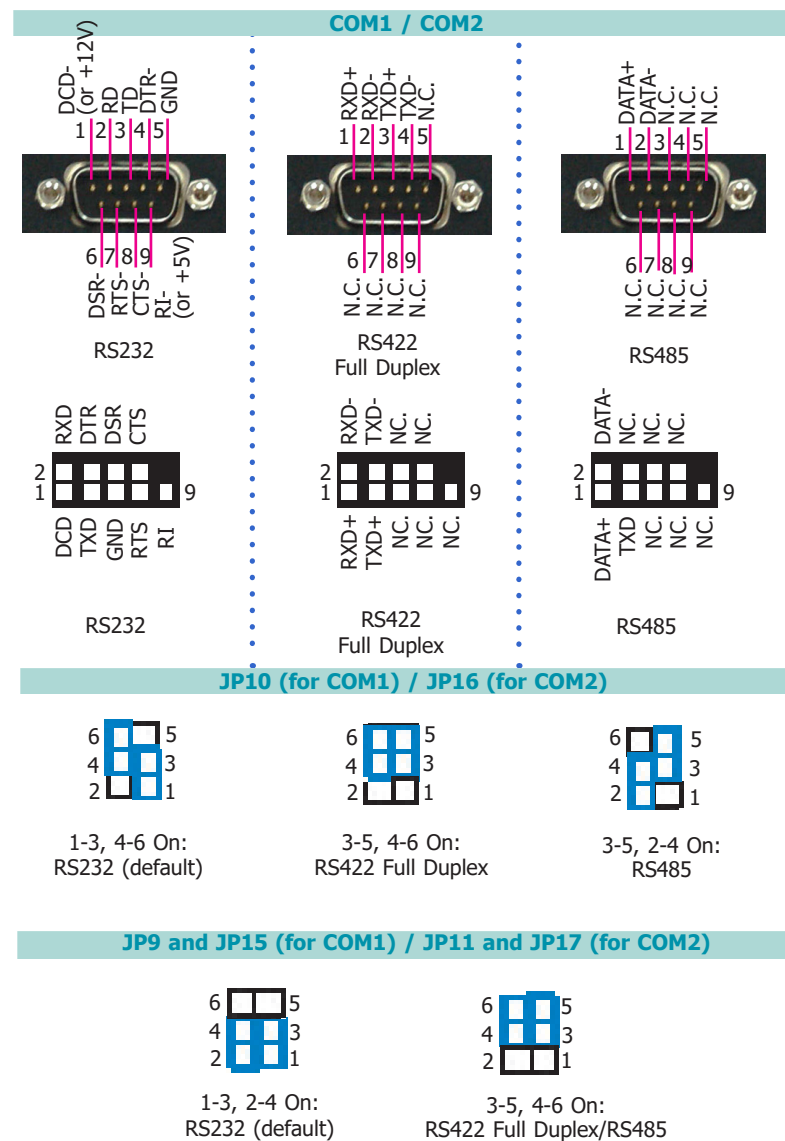
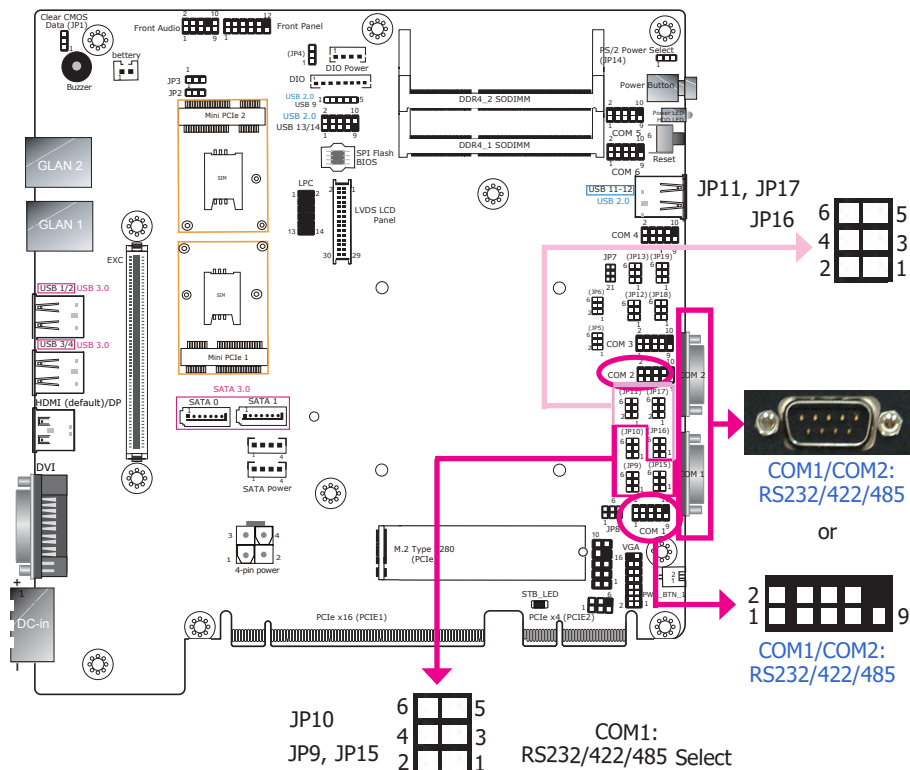

These jumpers allow you to configure the Serial COM ports to RS232, RS422 (full duplex) or RS485. JP9, JP10 and JP15 are used to configure Serial COM port 1; JP11, JP16 and JP17 are used to configure Serial COM port 2. The pin assignments of COM port 1 and COM port 2 will vary according to these jumpers' settings. You can also configure the RS485 auto flow mechanism through the BIOS setup utility. For more information, please refer to Chapter 7.



Note:

When COM1 RS232/422/485 is selected, JP9 and JP15 must be set in accordance to JP10. And when COM2 RS232/422/485 is selected, JP11 and JP17 must be set in accordance to JP16.

COM3/COM4 RS232/422/485 Select

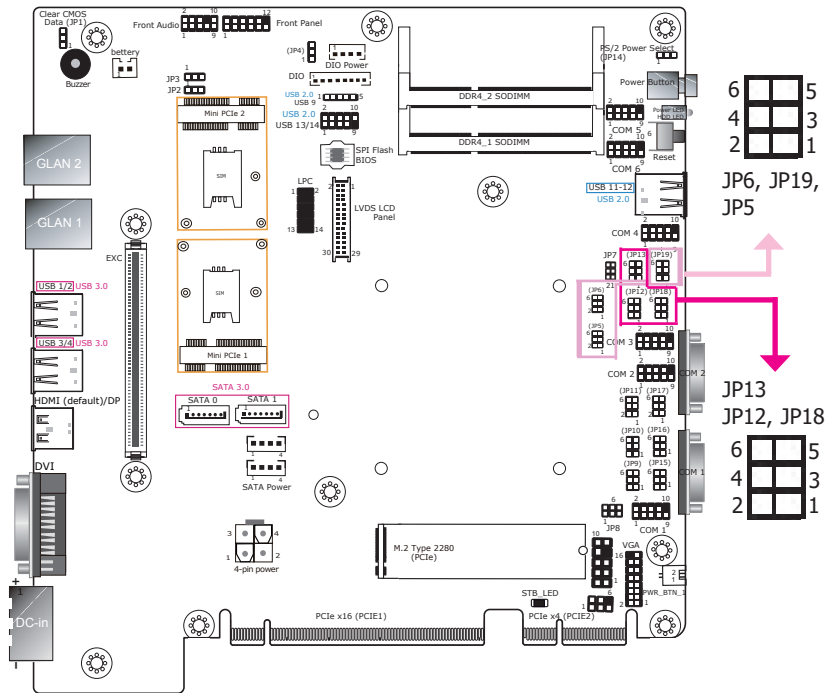

These jumpers allow you to configure the Serial COM ports to RS232, RS422 (full duplex) or RS485. JP12, JP13 and JP18 are used to configure Serial COM port 3; JP5, JP6 and JP19 are used to configure Serial COM port 4. The pin assignments of COM port 3 and COM port 4 will vary according to these jumpers' settings. You can also configure the RS485 auto flow mechanism through the BIOS setup utility. For more information, please refer to Chapter 7.



Note: When COM3 RS232/422/485 is selected, JP12 and JP18 must be set in accordance to JP13. And when COM4 RS232/422/485 is selected, JP6 and JP19 must be set in accordance to JP5.

COM3 / COM4

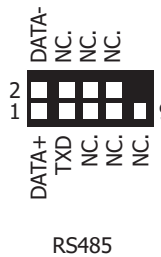
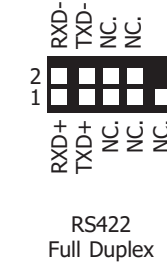
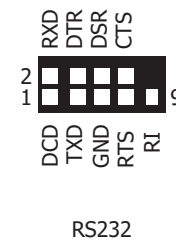
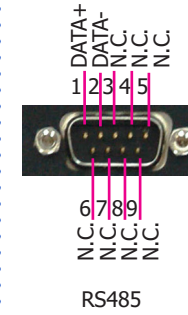
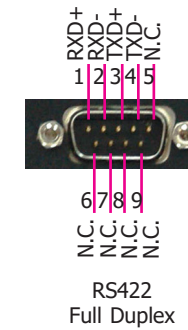
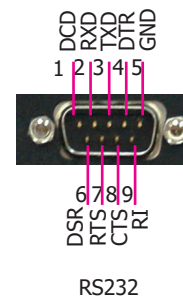

JP13 (for COM3) / JP5 (for COM4)

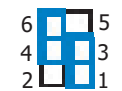

1-3, 4-6 On:
RS232 (default)

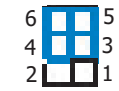

3-5, 4-6 On:
RS422 Full Duplex

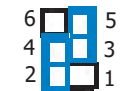

3-5, 2-4 On:
RS485

JP12 and JP18 (for COM3) / JP6 and JP19 (for COM4)



1-3, 2-4 On:
RS232 (default)

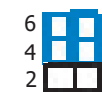

3-5, 4-6 On:
RS422 Full Duplex/RS485

DIO High/Low Select (DIO 0~3)

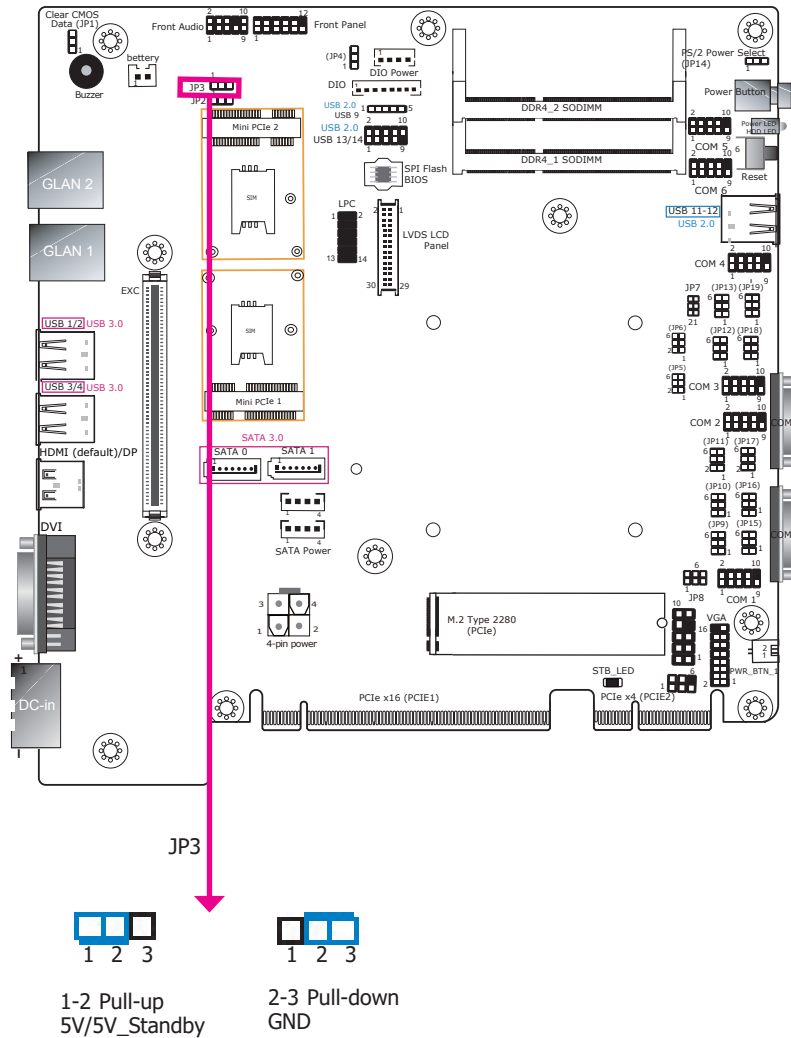

JP3 is used to set the digital pins 0~3 to pull-up or pull-down.

DIO High/Low Select (DIO 4~7)

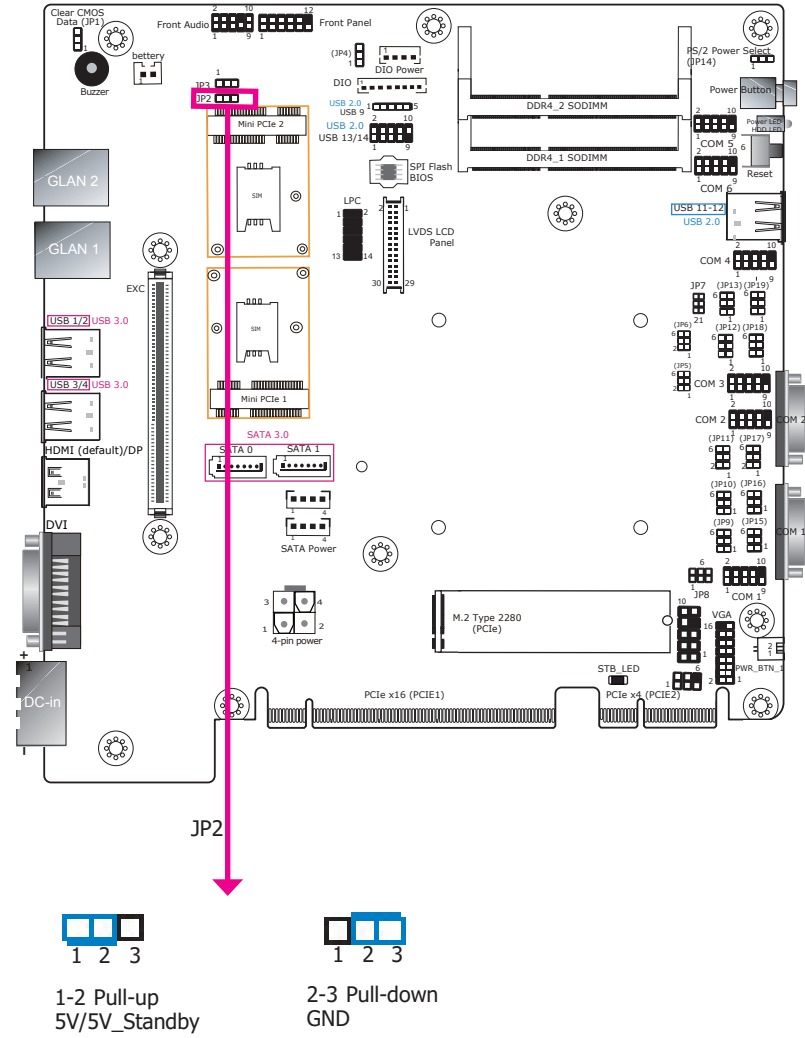

JP2 is used to set the digital pins 4~7 to pull-up or pull-down.

COM6 / COM7 / COM8 RS232/422/485 Select (daughter board)

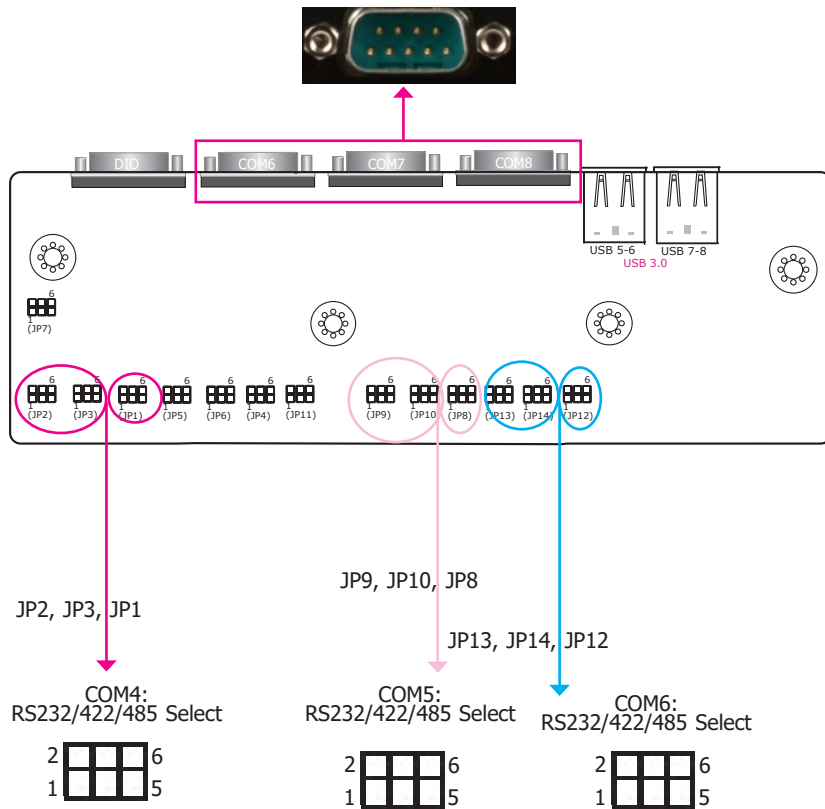

These jumpers (on the daughter board) allow you to configure the serial COM ports to RS232, RS422 (full duplex) or RS485. JP1, JP2 and JP3 are used to configure serial COM port 6. JP8, JP9 and JP10 are used to configure serial COM port 7. JP12, JP13 and JP14 are used to configure serial COM port 8. The pin assignments of COM port 6 to COM port 8 will vary according to these jumpers' settings. In addition, COM port 6 and COM port 7 can be switched between normal RS232 and RS232 with power (see below jumper settings on next page). You can also configure the RS485 auto flow mechanism with the BIOS setup utility. For more information, refer to Chapter 7.

- Notes:**
1. When COM6 RS232/422/485 is selected, JP2 and JP3 must be set in accordance to JP1.
 2. When COM7 RS232/422/485 is selected, JP9 and JP10 must be set in accordance to JP8.
 3. When COM8 RS232/422/485 is selected, JP13 and JP14 must be set in accordance to JP12.

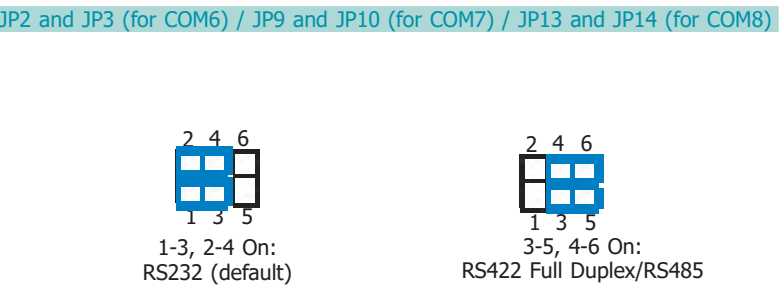
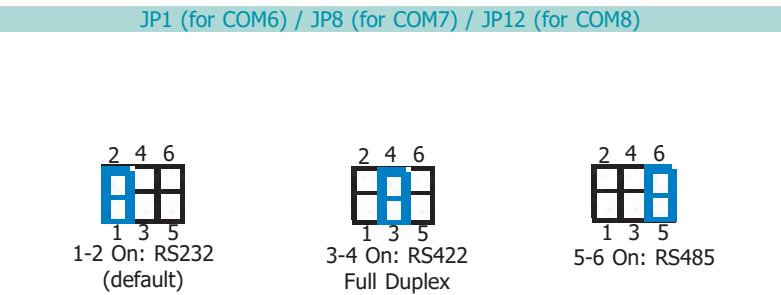
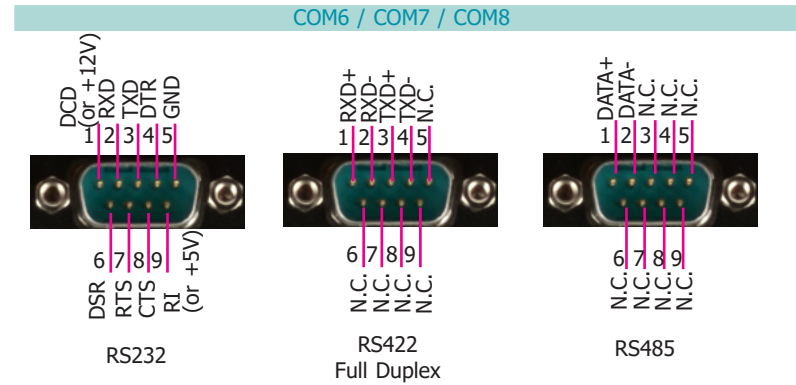

COM6/COM7 RS232 Power Select (daughter board)

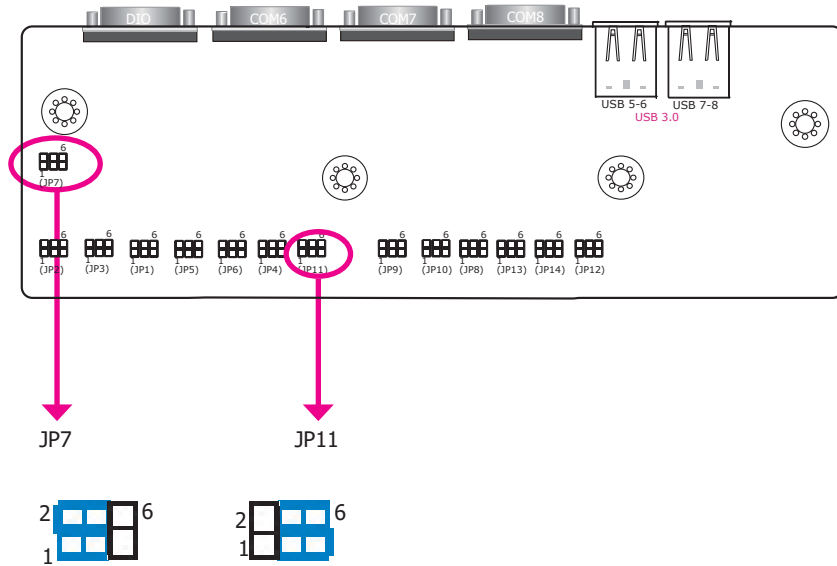

1-3 (RI), 2-4 (DCD) On: RS232 (default)
 3-5 (+5V), 4-6 (+12V) On: RS232 with power

JP7 (for COM6) and JP11 (for COM7) are used to configure serial COM ports on the daughter board to normal RS232 or RS232 with power. The pin assignments (Pin 1: optional 12V and Pin 9: optional 5V) of COM port 6 and COM port 7 will vary according to JP7's and JP11's setting respectively.

Chapter 5 - Ports and Connectors

Front Panel I/O Ports

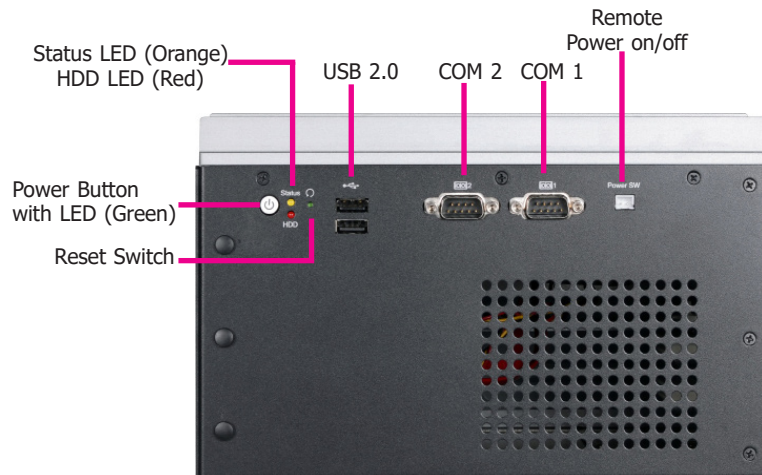

The front panel I/O consists of the following ports:

- Buttons and Swiches:
 - Power button with LED
 - Remote power-on/off switch
 - Reset switch
- LED Indicators:
 - Status and HDD LEDs
- USB:
 - Two USB 2.0 ports
- Serial Communication:
 - COM1 & COM2 are RS232/422/485 ports

Rear Panel I/O Ports

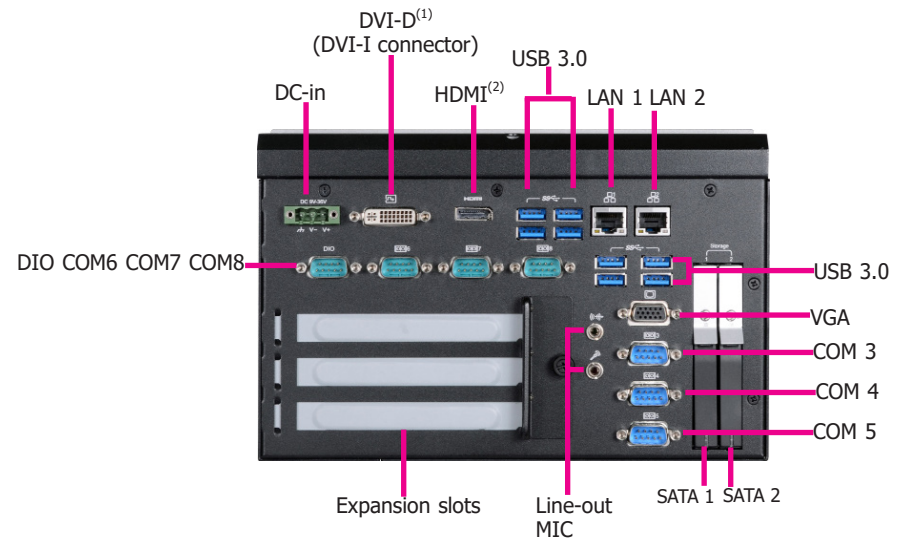

The rear panel I/O consists of the following ports:

- Power:
 - 9~36V DC-in
- Audio:
 - Line-out and microphone ports
- Storage:
 - SATA Drive Bay
- DIO:
 - One Digital I/O connector (8-bit DIO)
- Expansion:
 - Three expansion slots
- Display:
 - DVI-D (DVI-I connector)⁽¹⁾/HDMI ⁽²⁾/ VGA ports
- USB:
 - Eight USB 3.0 ports
- Ethernet:
 - Two RJ45 LAN ports
- Serial Communication:
 - COM3 to COM8 are RS232/422/485 ports
 - COM 5 is an RS232 port

Notes:

1. This port can be in HDMI or DVI-D (DVI available upon request).
2. This port is a DP/HDMI combo port but can only transmit either HDMI or DP signals (as indicated on the panel). Please plug in a DP or an HDMI cable with the right orientation and alignment to avoid damage to the connector. You should feel resistance (due to a pin on the right) if the cable is not inserted correctly. For detailed instructions, see <https://youtu.be/SUj07rN5I8>.

USB Ports (mainboard)

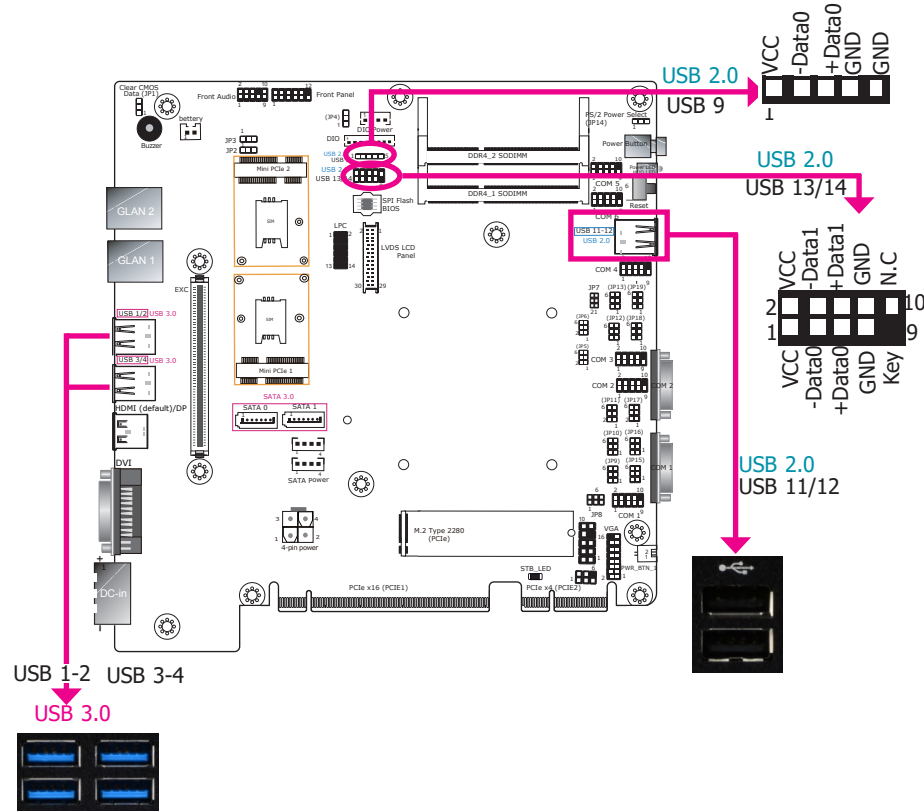

The USB device allows data exchange between your computer and a wide range of simultaneously accessible external Plug and Play peripherals. The system board is equipped with 4 USB 3.0 ports on the rear panel and 2 USB 2.0 ports on the front panel of the system unit. In addition, the system board provides 3 USB 2.0 ports via the internal pin headers.

- **BIOS Setting**

Configure the onboard USB in the Advanced menu ("USB Configuration" submenu) of the BIOS. Refer to Chapter 7 for more information.

USB Ports (daughter board)

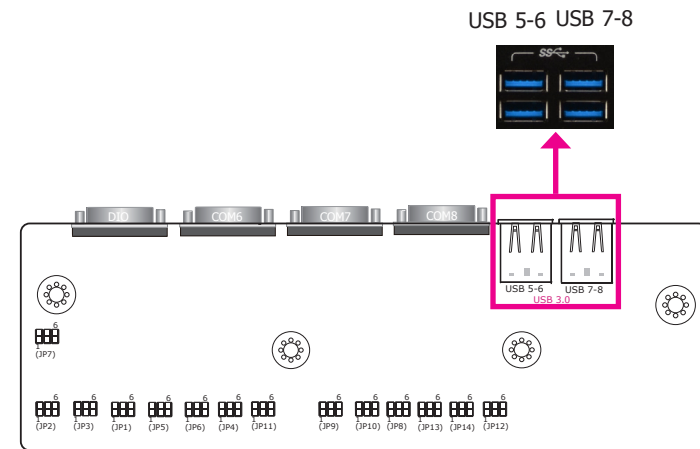

The daughter board provides 4 extra USB 3.0 ports to the system. USB 3.0 can transfer data up to 5 Gbps versus 480 Mbit/s in USB 2.0.

- **BIOS Setting**

Configure the onboard USB in the Advanced menu ("USB Configuration" submenu) of the BIOS. Refer to Chapter 7 for more information.

RJ45 LAN Ports

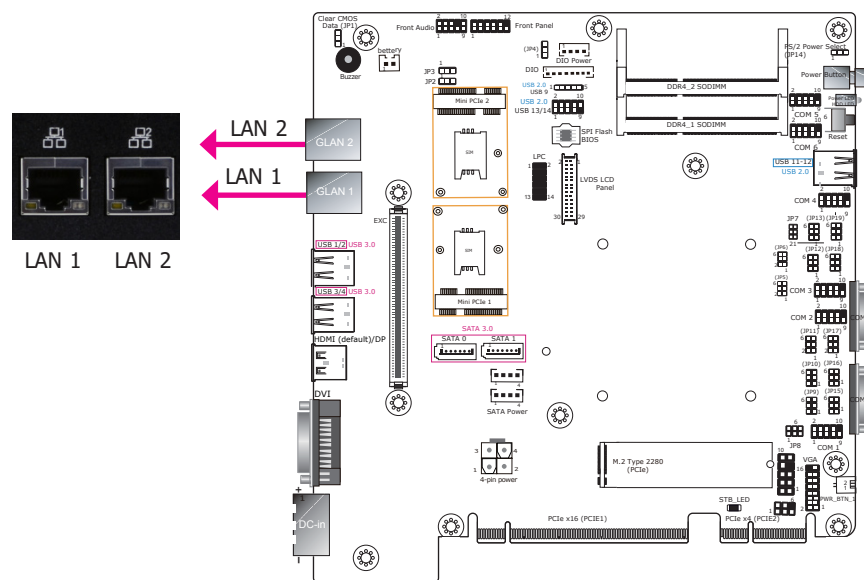

Features

- LAN 1: Intel® I219LM Ethernet controller with iAMT11.0 (Intel® Core™ i3 processors do not support iAMT)
- LAN 2: Intel® I211AT PCIe Gigabit Ethernet Controller

The LAN ports allow the system board to connect to a local area network with a network hub.

BIOS Setting

Configure the onboard LAN in the Advanced menu ("ACPI Configuration") of the BIOS. Refer to Chapter 7 for more information.

Driver Installation

Install the LAN drivers. Refer to Chapter 8 for more information.

Display Interfaces

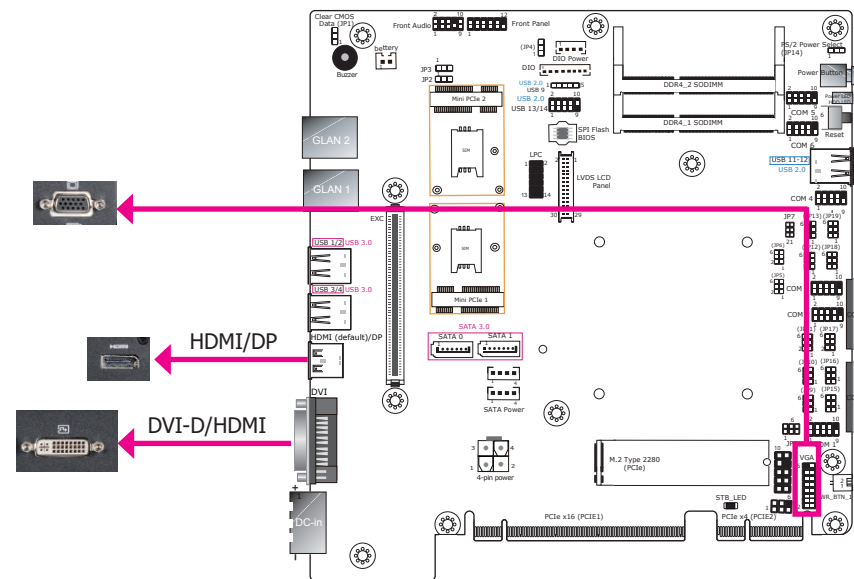

VGA Port

The VGA port is used for connecting a VGA monitor. Connect the monitor's 15-pin D-shell cable connector to the VGA port.

DVI-D (DVI-I Connector) Port or HDMI

The DVI-D port is used to connect a digital LCD monitor to transmit uncompressed digital video. This connector has a DVI-I receptacle but implements DVI-D signals (digital only).

Connect the display device's cable connector to the DVI-D port. After you plug the cable connector into the DVI-D port, gently tighten the cable screws to hold the connector in place. You can choose this port to be either DVI-D or HDMI.

HDMI Port or DisplayPort

The HDMI port which carries both digital audio and video signals is used to connect a LCD monitor or digital TV that has the HDMI port. You can choose this port to be either HDMI or DP.

BIOS Setting

Configure the display devices in the Advanced menu ("Video Configuration" submenu) of the BIOS. Please refer to the Chapter 7 for more information.

Driver Installation

Install the graphics driver. Please refer to Chapter 8 for more information.

COM (Serial) Ports

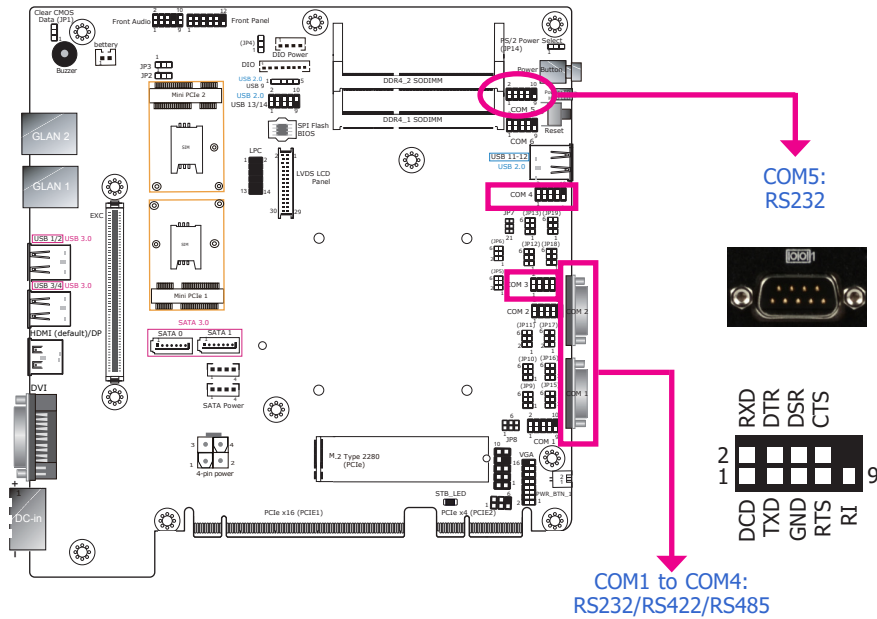

COM1 to COM4 can be selected among RS232/RS422/RS485 whereas **COM5** is fixed at RS232. For pin definitions and jumper selection of different communication modes, please refer to Chapter 4. COM6 to COM8 are from the daughter board; please refer to COM (Serial) Ports (daughter board) in this chapter for more information.

- **BIOS Setting**

Configure the serial ports in the Advanced menu ("Super IO Configuration" submenu) of the BIOS. Refer to Chapter 7 for more information.

COM (Serial) Ports (daughter board)

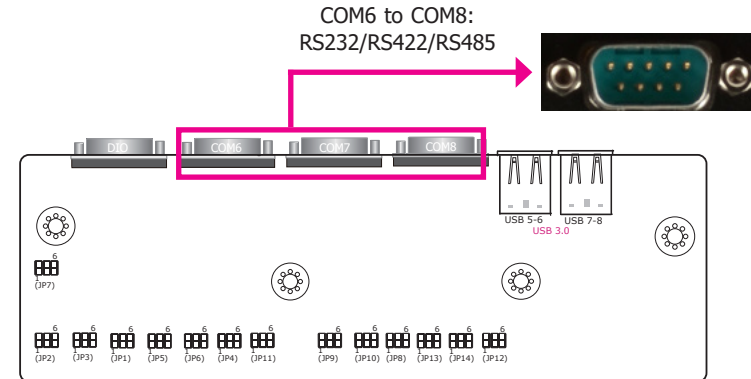

COM6 to COM8 can be selected among RS232, RS422 and RS485 via jumper settings. In addition, COM6 and COM7 can be switched between normal RS232 and RS232 with power. For pin assignments and jumper selection for different communication modes, please refer to Chapter 4.

- **BIOS Setting**

Configure the serial ports with advanced options such as the RS485 auto flow mechanism in the Advanced menu ("Super IO Configuration" submenu) of the BIOS. Refer to Chapter 7 for more information.

9~36V DC-in

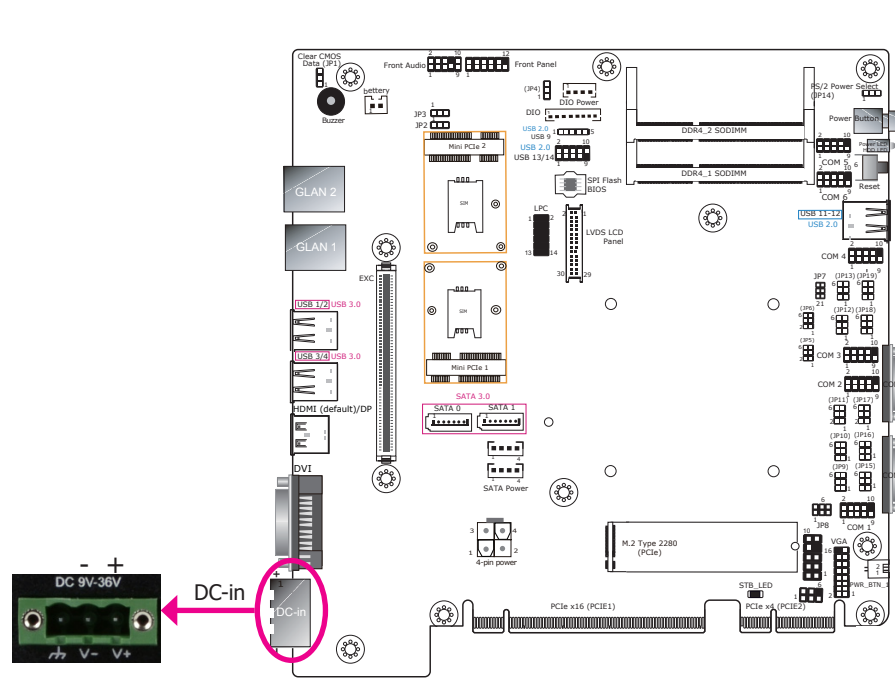

This jack provides a maximum of 160W power input solution. Connect a DC power cord to this jack. Using a voltage higher than the recommended one may fail to boot the system or cause damage to the system board.

Rear Audio Connector

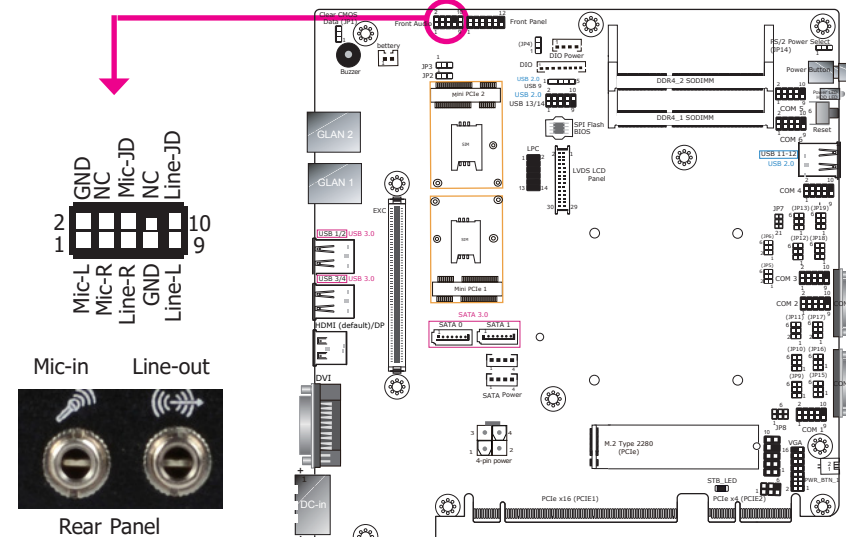

Rear Audio

The system board is equipped with 2 audio jacks.

- Line-out Jack
This jack is used to connect a headphone or external speakers.
- Mic-in Jack
This jack is used to connect an external microphone.

Driver Installation

Install the audio driver. Refer to the Chapter 8 for more information.

SATA (Serial ATA) & Power Connectors

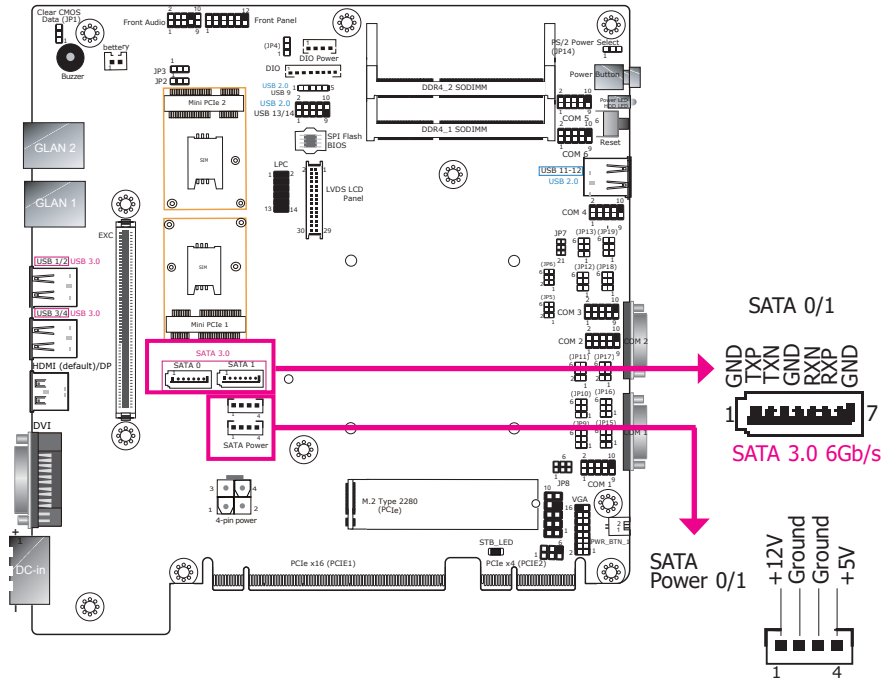

Features

- 2 Serial ATA 3.0 ports
 - SATA port 0 and 1 with data transfer rate up to 6Gb/s
- Integrated Advanced Host Controller Interface (AHCI) controller

The Serial ATA connectors are used to connect Serial ATA devices. Connect one end of the Serial ATA data cable to the SATA connector on the system board and the other end to your Serial ATA device.

The power cable must be connected from the system board's Serial ATA power connector to the SATA drive's power connector to provide power to the drive.

BIOS Setting

Configure the Serial ATA drives in the Advanced submenu ("SATA Configuration" section) of the BIOS. Refer to Chapter 7 for more information.

SMBus Connector

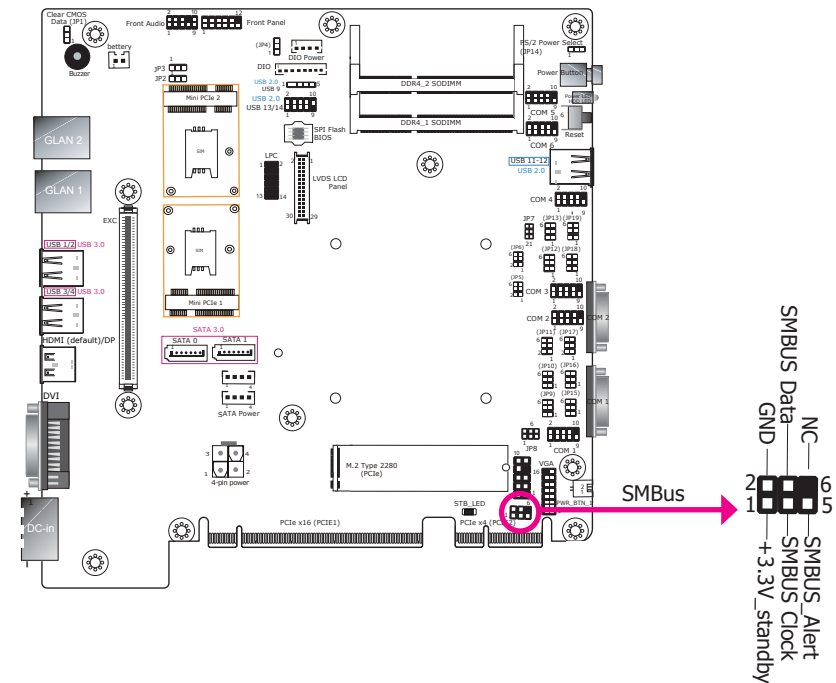

The SMBus (System Management Bus) connector is used to connect SMBus devices. It is a bus that allows multiple low-bandwidth devices to connect to the same bus and each device can act as the master by initiating data transfer.

Digital I/O Connector & DIO Power (mainboard)

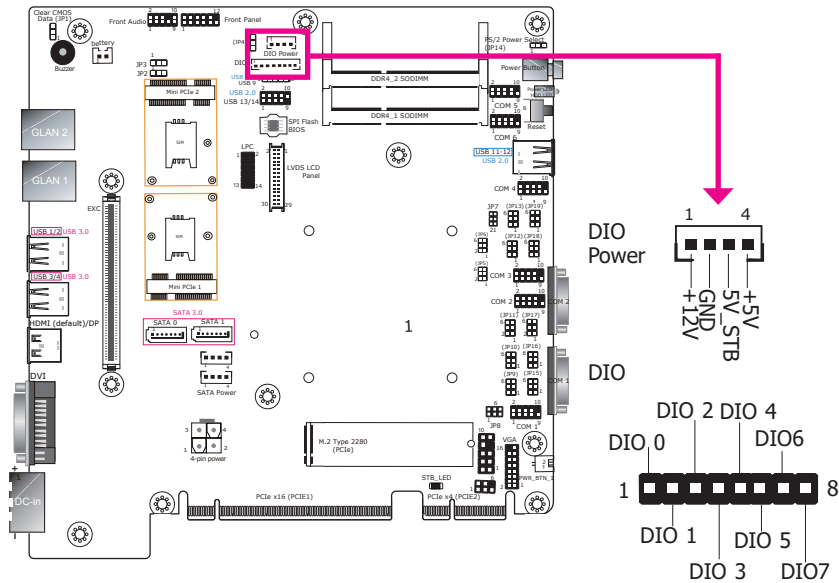

The 8-bit Digital I/O connector provides 8-bit digital input/output signals to provide the ability to monitor and control the states of the connected external devices.

Digital I/O Connector

Pins	Function
1	DIO 0
2	DIO 1
3	DIO 2
4	DIO 3
5	DIO 4
6	DIO 5
7	DIO 6
8	DIO 7

Digital I/O Power

Pins	Function
1	+12V
2	GND
3	5V_Standby
4	5V

Digital I/O Connector (daughter board)

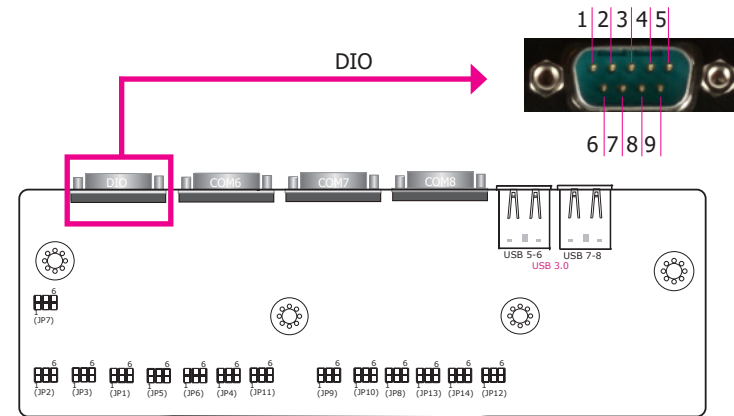

The Digital I/O connector provides 8 digital inputs or outputs that enable monitor and control of the state of the connected external devices. We have built support software called EAPI that allows for the communication and control of the hardware components. Please contact our technical support or sales representatives for the support software package.

Digital I/O Connector

Pins	DIO
1	DIO8
2	DIO9
3	DIO10
4	DIO11
5	GND
6	DIO12
7	DIO13
8	DIO14
9	DIO15

Front Panel Connector

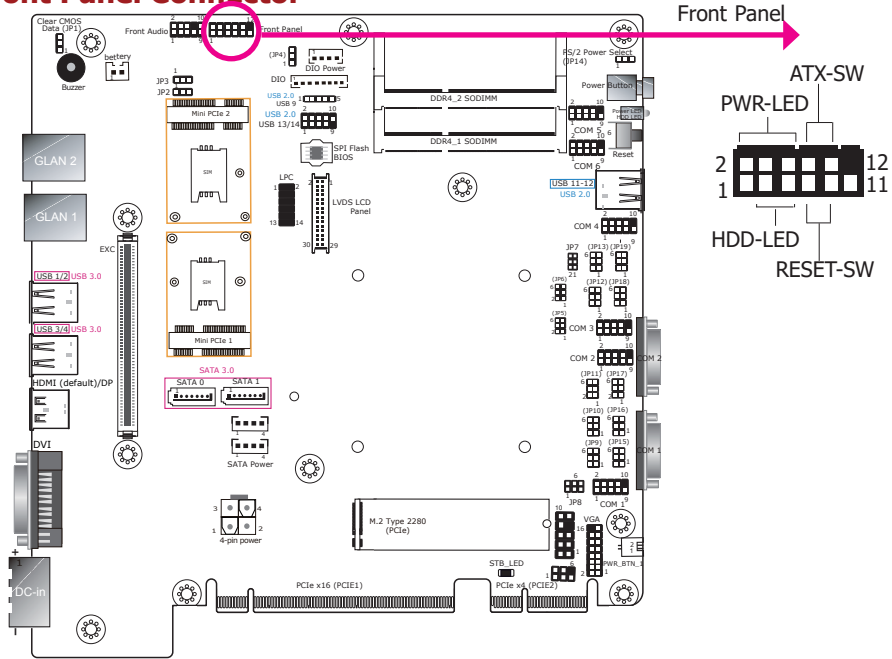

12V DC-out

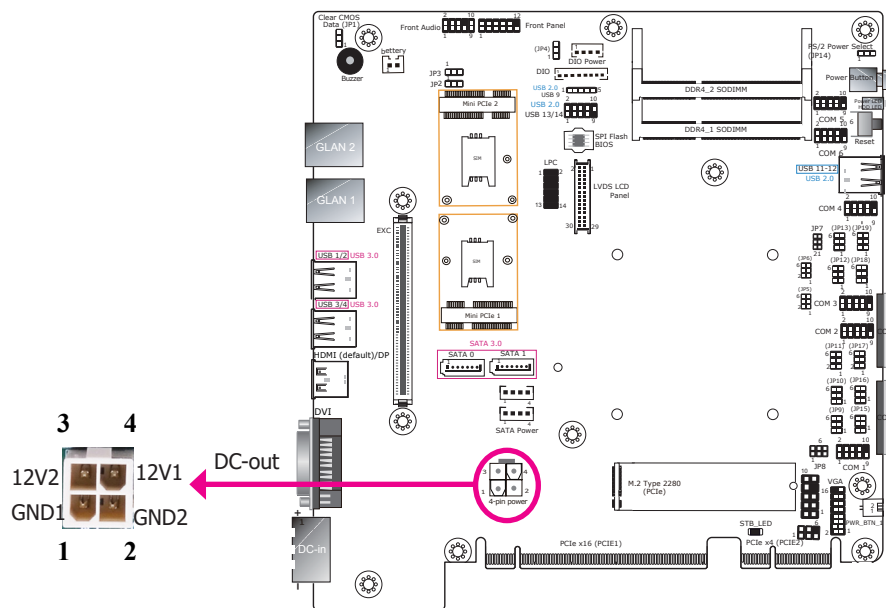

HDD-LED - HDD LED

This LED will be lit when the hard drive is being accessed.

RESET SW - Reset Switch

This switch allows you to reboot without having to power off the system.

ATX-SW - ATX Power Switch

This switch is used to power on or off the system.

PWR-LED - Power/Standby LED

When the system's power is on, this LED will light. When the system is in the S1 (POS - Power On Suspend) state, it will blink every second. When the system is in the S3 (STR - Suspend To RAM) state, it will blink every 4 seconds.

	Pin	Pin Assignment		Pin	Pin Assignment
HDD-LED	3	HDD Power	PWR-LED	2	LED Power
	5	Signal		4	LED Power
RESET SW	7	Ground	ATX-SW	6	Signal
	9	RST Signal		8	Ground
	11	N.C.		10	Signal

The 4-pin vertical type connector (optional) provides low power output:

Max: 2.0A (24W) with 35/25W CPU
Max: 1.5A (18W) with 45W CPU

Please refer to "Specifications" in Chapter 1 for the system's processor list.

Expansion Slots

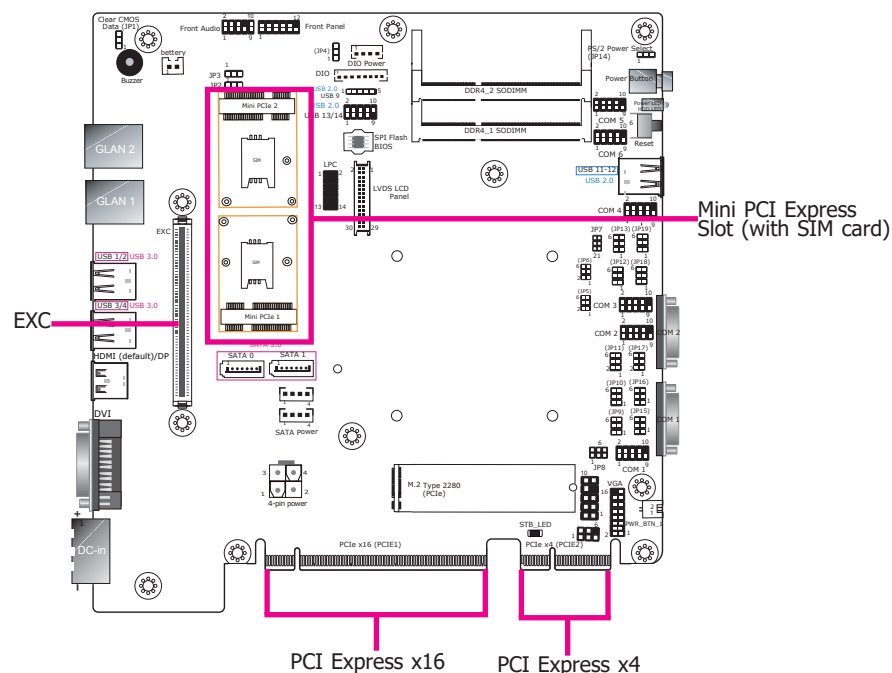

Dual Mini PCIe Slots (with Mini SIM Card Slots)

The Mini PCIe socket is used to install a Mini PCIe card. The system is equipped with two full-size (or half-size) Mini PCIe slot slots (Mini PCIe 1: PCIe & USB signals; Mini PCIe 2: USB signals only). The Mini PCIe slots together with the paired Mini SIM card slots provide the system with wireless LAN and broadband communication.

PCI Express x16 Slot

Install PCI Express x16 graphics card, that comply to the PCI Express specifications, into the PCI Express x16 slot such as a graphics card.

PCI Express x4 Slot

Install PCI Express cards such as network cards or other cards that comply to the PCI Express specifications into this slot.

EXC Slot

The EXC interface is used to install an EXC card for I/O expansion via a daughter board.

Pin	Pin Assignment	Pin	Pin Assignment
1	GND	2	GND
3	PCIE_ECX_RX1p	4	PCIE_ECX_RX2p
5	PCIE_ECX_RX1n	6	PCIE_ECX_RX2n
7	PCIE_ECX_TX1n	8	PCIE_ECX_TX2n
9	PCIE_ECX_TX1p	10	PCIE_ECX_TX2p
11	CLK_PCIE_ECX1_p	12	CLK_PCIE_ECX2_p
13	CLK_PCIE_ECX1_n	14	CLK_PCIE_ECX2_n
15	Reserved	16	Reserved
17	Reserved	18	Reserved
19	GND	20	GND
21	CLK_PCIE_ECX3_p	22	PCIE_ECX_RX5p (N/A)
23	CLK_PCIE_ECX3_n	24	PCIE_ECX_RX5n (N/A)
25	GND	26	PCIE_ECX_TX5n (N/A)
27	SATA_LED#	28	PCIE_ECX_TX5p (N/A)
29	EDP_AUX_n (N/A)	30	CLK_PCIE_ECX5_p (N/A)
31	EDP_AUX_p (N/A)	32	CLK_PCIE_ECX5_n (N/A)
33	Intel Control Link Bus	34	Reserved
35	Intel Control Link Bus	36	Reserved
37	Intel Control Link Bus	38	HD_OUT (N/A)
39	GND	40	GND
41	EDP_LAN0_n	42	PCIE_ECX_RX4p
43	EDP_LAN0_p	44	PCIE_ECX_RX4n
45	EDP_LAN1_n	46	PCIE_ECX_TX4n
47	EDP_LAN1_p	48	PCIE_ECX_TX4p
49	EDP_LAN2_n	50	CLK_PCIE_ECX4_p
51	EDP_LAN2_p	52	CLK_PCIE_ECX4_n
53	DPC_AUX_n (N/A)	54	Reserved
55	DPC_AUX_p (N/A)	56	Reserved
57	EDP_HPD	58	Reserved
59	GND	60	GND
61	EDP_LAN3_n	62	LPC_FRAME#
63	EDP_LAN3_p	64	LPC_AD0
65	DPB_CTRL_CLK (N/A)	66	LPC_AD1
67	DPB_CTRL_DATA (N/A)	68	LPC_AD2
69	DPC_CTRL_CLK (N/A)	70	LPC_AD3
71	DPC_CTRL_DATA (N/A)	72	LPC_LDRQ1#
73	Reserved	74	DPC_HPD (N/A)

75	PLT-RST#	76	CLK_LPC
77	HD_RST# (N/A)	78	HD_SPKR (N/A)
79	GND	80	GND
81	DPC_LAN0_n (N/A)	82	USB3_RX0n
83	DPC_LAN0_p (N/A)	84	USB3_RX0p
85	DPC_LAN1_n (N/A)	86	GND
87	DPC_LAN1_p (N/A)	88	USB3_TX0n
89	DPC_LAN2_n (N/A)	90	USB3_TX0p
91	DPC_LAN2_p (N/A)	92	GND
93	DPC_LAN3_n (N/A)	94	HD_BITCLK (N/A)
95	DPC_LAN3_p (N/A)	96	HD_SYNC (N/A)
97	USB_PWR_SEL	98	HD_SIN (N/A)
99	GND	100	GND
101	USB_1P	102	USB3_RX1n
103	USB_1N	104	USB3_RX1p
105	USB_OP	106	GND
107	USB_ON	108	USB3_TX1n
109	USB_OC#	110	USB3_TX1p
111	PCIE_ECX_RX3p	112	GND
113	PCIE_ECX_RX3n	114	SATA_TXn
115	PCIE_ECX_TX3n	116	SATA_TXp
117	PCIE_ECX_TX3p	118	Reserved
119	GND	120	GND
121	BID	122	GND
123	SMB_CLK_RESUME	124	DFI Board ID_0
125	SMB_DATA_RESUME	126	DFI Board ID_1
127	INT_GPIO#	128	DFI Board ID_2
129	PCIe_Wake#	130	SATA_RXn
131	INT_SERIRQ	132	SATA_RXp
133	VIN	134	VIN
135	+3.3VDU	136	+5VDU
137	+3.3VDU	138	+5VDU
139	GND	140	GND
141	+12V	142	+3.3V
143	+12V	144	+3.3V
145	+12V	146	+3.3V
147	+12V	148	+3.3V
149	GND	150	GND
151	+5V	152	+5V
153	+5V	154	+5V
155	+5V	156	+5V
157	+5V	158	+5V
159	+5V	160	+5V

PS/2 KB/MS Connector

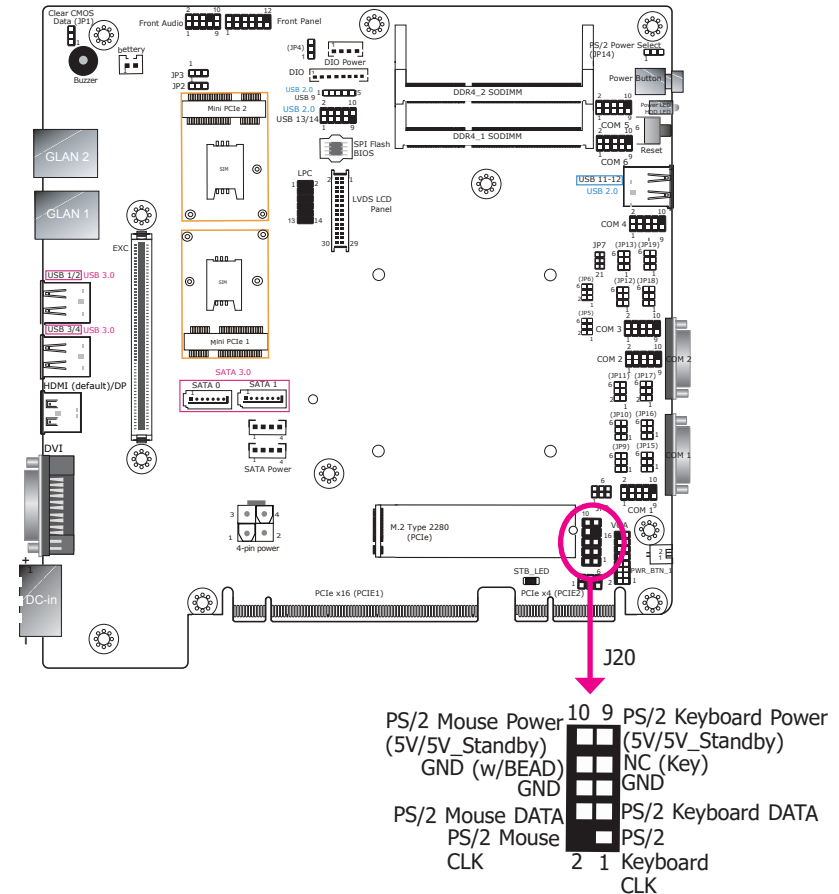

The 10-pin connector is used to connect PS/2 keyboard and mouse.

LPC Connector

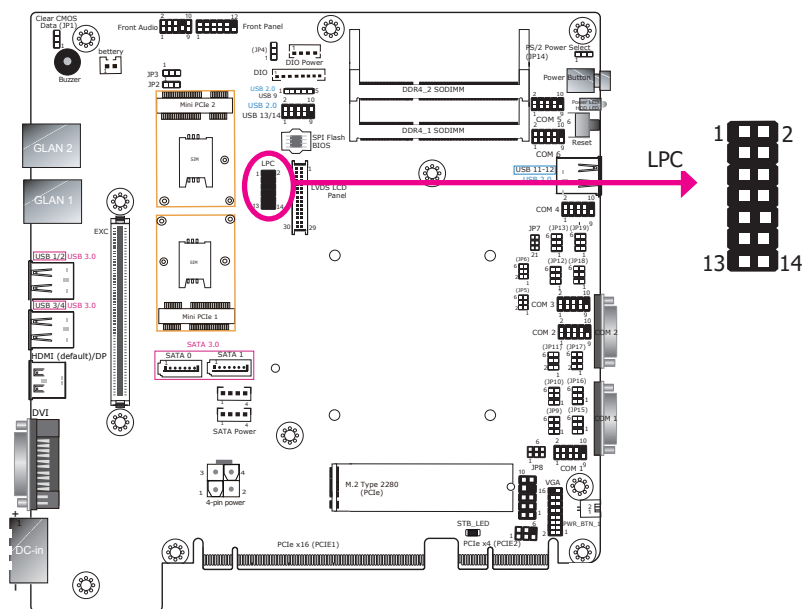

The Low Pin Count Interface was defined by Intel® Corporation to facilitate the industry's transition towards legacy free systems. It allows the integration of low-bandwidth legacy I/O components within the system, which are typically provided by a Super I/O controller. Furthermore, it can be used to interface firmware hubs, Trusted Platform Module (TPM) devices and embedded controller solutions. Data transfer on the LPC bus is implemented over a 4 bit serialized data interface, which uses a 24MHz LPC bus clock. For more information about LPC bus refer to the Intel® Low Pin Count Interface Specification Revision 1.1'. The table below indicates the pin functions of the LPC connector.

Pin	Pin Assignment	Pin	Pin Assignment
1	L_CLK	2	L_AD1
3	L_RST#	4	L_AD0
5	L_FRAME#	6	3V3
7	L_AD3	8	GND
9	L_AD2	10	Kev
11	INT_SERIRQ	12	GND
13	5VSB	14	5V

Chapter 6 - Mounting Options

Wall Mount

The wall mount kit includes the following:

- 2 Wall mount brackets
- 4 Bracket screws



1. The wall mounting holes are located on the bottom of the system unit.

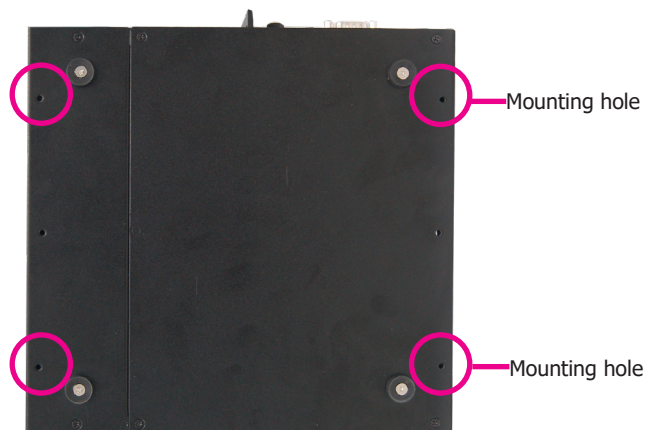

2. Use the provided mounting screws to secure the wall mount brackets on each side of the system unit.

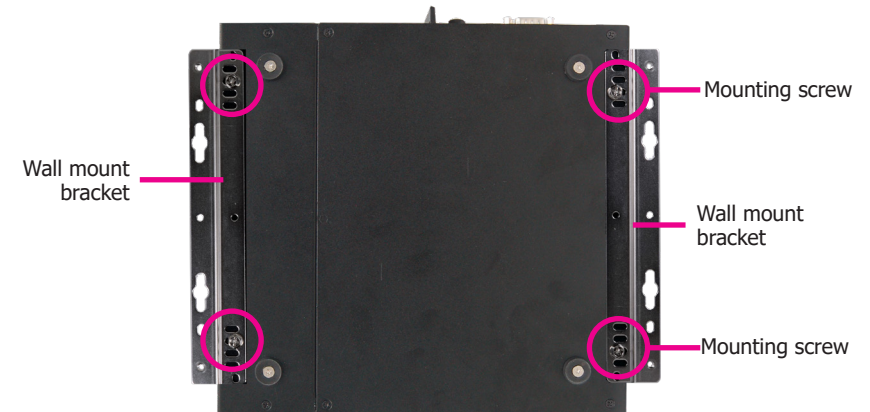

The following illustration shows the location and dimensions of the mounting holes.

