



# CS332-C246/Q370

MicroATX Industrial Motherboard  
User's Manual

## Copyright

This publication contains information that is protected by copyright. No part of it may be reproduced in any form or by any means or used to make any transformation/adaptation without the prior written permission from the copyright holders.

This publication is provided for informational purposes only. The manufacturer makes no representations or warranties with respect to the contents or use of this manual and specifically disclaims any express or implied warranties of merchantability or fitness for any particular purpose. The user will assume the entire risk of the use or the results of the use of this document. Further, the manufacturer reserves the right to revise this publication and make changes to its contents at any time, without obligation to notify any person or entity of such revisions or changes.

Changes after the publication's first release will be based on the product's revision. The website will always provide the most updated information.

© 2024. All Rights Reserved.

## Trademarks

Product names or trademarks appearing in this manual are for identification purpose only and are the properties of the respective owners.

## FCC and DOC Statement on Class B

This equipment has been tested and found to comply with the limits for a Class B digital device, pursuant to Part 15 of the FCC rules. These limits are designed to provide reasonable protection against harmful interference when the equipment is operated in a residential installation. This equipment generates, uses and can radiate radio frequency energy and, if not installed and used in accordance with the instruction manual, may cause harmful interference to radio communications. However, there is no guarantee that interference will not occur in a particular installation. If this equipment does cause harmful interference to radio or television reception, which can be determined by turning the equipment off and on, the user is encouraged to try to correct the interference by one or more of the following measures:

- Reorient or relocate the receiving antenna.
- Increase the separation between the equipment and the receiver.
- Connect the equipment into an outlet on a circuit different from that to which the receiver is connected.
- Consult the dealer or an experienced radio TV technician for help.

## Notice:

1. The changes or modifications not expressly approved by the party responsible for compliance could void the user's authority to operate the equipment.
2. Shielded interface cables must be used in order to comply with the emission limits.

# Table of Contents

Chapter 1 - Introduction.....	6
Specifications .....	6
Block Diagram .....	9
Dimension .....	9
Chapter 2 - Hardware Installation.....	10
Board Layout.....	10
Installing the heat sink.....	12
Installing the Heat Sink .....	12
Jumper Settings .....	13
Digital I/O (DIO) Power Select (JP17).....	13
Digital I/O (DIO) Power Supply (JP18 & JP19).....	13
COM 1 Serial Mode (JP1, JP2, JP3).....	14
COM 1 RS232 Power Select (JP4).....	14
Clear CMOS (JP5) .....	15
HSIO Signal Trace Selection (JP20).....	15
Mini PCIe/mSATA Select (JP9).....	16
Pin Assignment .....	17
SMBus (J12) .....	17
Front Panel (J18).....	17
Chassis Intrusion (J14).....	18
Digital I/O (J26).....	18
SYSTEM FAN1/2/3 (J7 & J22 & J30 ) .....	19
CPU FAN (J8).....	19
SATA0, 1, 2, 3, 4 (J28 & J23 & J17 & J25 & J27) .....	20
LAN 1/2 LED & LAN 3/4 LED ( J19 & J31) .....	20
LPC (J21) .....	21
S/PDIF ( J1) .....	21
Front Audio ( J2).....	22
System Memory .....	23
Installing the DIMM Module .....	23
Expansion Slots.....	24
Installing the M.2 Module .....	24
Chapter 3 - BIOS Settings.....	26
Overview .....	26
Main.....	27
Advanced .....	27
RC ACPI Settings.....	28
CPU Configuration.....	28
Power & Performance.....	29
PCH-FW Configuration.....	29
Trusted Computing.....	30
NCT6116D Super IO Configuration .....	30
NCT6116D Super IO Configuration ▶ <b>Serial Port 1, 2 Configuration</b> .....	<b>31</b>
NCT6116D Super IO Configuration ▶ <b>Serial Port 3, 4 Configuration</b> .....	<b>31</b>
NCT6116D HW Monitor .....	32
NCT6116D HW Monitor ▶ <b>Smart FAN Function</b> .....	<b>32</b>
Serial Port Console Redirection .....	33
Serial Port Console Redirection ▶ <b>Console Redirection Settings</b> .....	<b>33</b>
Serial Port Console Redirection ▶ <b>Console Redirection Settings</b> .....	<b>34</b>
USB Configuration .....	35
CSM Configuration .....	35
USB Power Control .....	36
Network Stack Configuration.....	36

Chipset .....	37
Graphics Configuration .....	37
PEG Port Configuration.....	38
PCH-IO Configuration.....	38
PCH-IO Configuration ▶ <b>PCI Express Configuration</b> .....	<b>39</b>
PCH-IO Configuration ▶ <b>SATA Configuration</b> .....	<b>39</b>
PCH-IO Configuration ▶ <b>HD Audio Configuration</b> .....	<b>40</b>
Security .....	41
Secure Boot.....	41
Boot .....	42
Save & Exit .....	42
Updating the BIOS .....	43
Notice: BIOS SPI ROM.....	43

## About this Manual

This manual can be downloaded from the website.

The manual is subject to change and update without notice, and may be based on editions that do not resemble your actual products. Please visit our website or contact our sales representatives for the latest editions.

## Warranty

1. Warranty does not cover damages or failures that occur from misuse of the product, inability to use the product, unauthorized replacement or alteration of components and product specifications.
2. The warranty is void if the product has been subjected to physical abuse, improper installation, modification, accidents or unauthorized repair of the product.
3. Unless otherwise instructed in this user's manual, the user may not, under any circumstances, attempt to perform service, adjustments or repairs on the product, whether in or out of warranty. It must be returned to the purchase point, factory or authorized service agency for all such work.
4. We will not be liable for any indirect, special, incidental or consequential damages to the product that has been modified or altered.

## Static Electricity Precautions

It is quite easy to inadvertently damage your PC, system board, components or devices even before installing them in your system unit. Static electrical discharge can damage computer components without causing any signs of physical damage. You must take extra care in handling them to ensure against electrostatic build-up.

1. To prevent electrostatic build-up, leave the system board in its anti-static bag until you are ready to install it.
2. Wear an antistatic wrist strap.
3. Do all preparation work on a static-free surface.
4. Hold the device only by its edges. Be careful not to touch any of the components, contacts or connections.
5. Avoid touching the pins or contacts on all modules and connectors. Hold modules or connectors by their ends.



### Important:

Electrostatic discharge (ESD) can damage your processor, disk drive and other components. Perform the upgrade instruction procedures described at an ESD workstation only. If such a station is not available, you can provide some ESD protection by wearing an antistatic wrist strap and attaching it to a metal part of the system chassis. If a wrist strap is unavailable, establish and maintain contact with the system chassis throughout any procedures requiring ESD protection.

## Safety Measures

- To avoid damage to the system, use the correct AC input voltage range.
- To reduce the risk of electric shock, unplug the power cord before removing the system chassis cover for installation or servicing. After installation or servicing, cover the system chassis before plugging the power cord.

## About the Package

The package contains the following items. If any of these items are missing or damaged, please contact your dealer or sales representative for assistance.

- 1 CS332-C246/Q370 motherboard
- 1 Serial ATA data cable (W/LOCK, Length: 500mm)
- 1 I/O shield
- 1 M.2 2242/2260/half mini PCIe standoff
- 2 M.2 Screw

The board and accessories in the package may not come similar to the information listed above. This may differ in accordance with the sales region or models in which it was sold. For more information about the standard package in your region, please contact your dealer or sales representative.

## Before Using the System Board

When installing the system board in a new system, you will need at least the following internal components.

- Memory module
- Storage device such as a hard disk drive.
- Power supply

External system peripherals may also be required for navigation and display, including at least a keyboard, a mouse and a video display monitor.

## Chapter 1 - Introduction

### ► Specifications

SYSTEM	Processor	8th Generation Intel® Core™ /Pentium®/Celeron® LGA 1151 Socket Processors, TDP support up to 95W: Intel® Core™ i7-8700 (6 Cores, 12M Cache, up to 4.6 GHz); 65W Intel® Core™ i7-8700T (6 Cores, 12M Cache, up to 4.0 GHz); 35W Intel® Core™ i5-8500 (6 Cores, 9M Cache, up to 4.1 GHz); 65W Intel® Core™ i5-8500T (6 Cores, 9M Cache, up to 3.5 GHz); 35W Intel® Core™ i3-8100 (4 Cores, 6M Cache, 3.6 GHz); 65W Intel® Core™ i3-8100T (4 Cores, 6M Cache, to 3.1 GHz); 35W Intel® Pentium® G5400 (2 Cores, 4M Cache, 3.7 GHz); 58W Intel® Pentium® G5400T (2 Cores, 4M Cache, 3.1 GHz); 35W Intel® Celeron® G4900 (2 Cores, 2M Cache, 3.1 GHz); 54W Intel® Celeron® G4900T (2 Cores, 2M Cache, 2.9 GHz); 35W  9th Generation Intel® Core™ LGA 1151 Socket Processors, TDP support up to 95W: Intel® Core™ i7-9700E (8 Cores, 12M Cache, up to 4.4 GHz); 65W Intel® Core™ i7-9700TE (8 Cores, 12M Cache, up to 3.8 GHz); 35W Intel® Core™ i5-9500E (6 Cores, 9M Cache, up to 4.2 GHz); 65W Intel® Core™ i5-9500TE (6 Cores, 9M Cache, up to 3.6 GHz); 35W Intel® Core™ i3-9100E (4 Cores, 6M Cache, 3.7 GHz); 65W Intel® Core™ i3-9100TE (4 Cores, 6M Cache, to 3.2 GHz); 35W
	Chipset	Intel® C246/Q370 Chipset
	Memory	Four 288-pin UDIMM up to 128GB Dual Channel DDR4 2400/2666 MHz (ECC support: C246 only)
	BIOS	AMI SPI 128Mbit
	GRAPHICS	Controller
	Feature	OpenGL 5.0, DirectX 12, OpenCL 2.1 HW Decode: AVC/H.264, MPEG2, VC1/WMV9, JPEG/MJPEG, HEVC/H265, VP8, VP9 HW Encode: MPEG2, AVC/H264, JPEG, HEVC/H265, VP8, VP9
	Display	1 x VGA, resolution up to 1920x1200 @ 60Hz 2 x DP++, resolution up to 4096x2304 @ 60Hz
	Triple Displays	VGA + DP++ + DP++
EXPANSION	Interface	1 x PCIe x16 (Gen 3) 2 x PCIe x4 (Gen 3) 1 x PCI 1 x MINI PCIE SLOT (Full Size) 1 x M.2 2242/2280 M key (PCIe Gen3 x 4 NVMe/Intel Optane Memory Support) 1 x M.2 2230 E key (PCIe x1/USB2.0)

AUDIO	Audio Codec	Realtek ALC888S
ETHERNET	Controller	1 x Intel® i219LM PCIe (10/100/1000Mbps) (only Xeon, Core i7/i5 support iAMT) 1 x Intel® i210AT PCIe (10/100/1000Mbps) 2 x Intel® i210AT PCIe (10/100/1000Mbps) (opt. by request, MOQ required)
REAR I/O	Ethernet	2 x 2.5GbE (RJ-45) or 4 x GbE (RJ-45) (opt. by request, MOQ required)
	USB	4 x USB 3.2 Gen 2 2 x USB 2.0
	Serial	1 x RS-232/422/485 (RS-232 w/ power) (DB-9)
	PS/2	1 x PS/2 (mini-DIN-6)
	Display	1 x VGA 2 x DP++
	Audio	1 x Line-out 1 x Mic-in 1 x Line-in (colay, opt. by request, MOQ required)
	INTERNAL I/O	Serial
USB		2 x USB 3.2 Gen 1 4 x USB 2.0 (2.54mm pitch)
Audio		1 x S/PDIF, 1 x Front Audio Header
SATA		4 x SATA 3.0 (up to 6Gb/s) (opt. x5 SATA) RAID 0/1/5/10
DIO		1 x 8-bit DIO
LPC		1 x LPC (support LPC EXT-RS-232/485 module)
SMBus		1 x SMBus
WATCHDOG TIMER	Output & Interval	System Reset, Programmable via Software from 1 to 255 Seconds
SECURITY	TPM	TPM 2.0
POWER	Type	ATX
	Connector	8-pin ATX 12V power 24-pin ATX power
	Consumption	Typical: i7-8700K: 3.3V @ 0.44A (1.452Watt); 5V @ 0.62A (3.1Watt); 12V @ 0.49A (5.88Watt) Max.: i7-8700K: 3.3V @ 0.51A (1.683Watt); 5V @ 1.4A (7.0Watt); 12V @ 10.44A (128.25Watt)
	RTC Battery	CR2032 Coin Cell
OS SUPPORT		Windows 10 IoT Enterprise 64-bit Linux

ENVIRONMENT	Temperature	Operating: -5 to 65°C Storage: -30 to 60°C with RTC Battery; -40 to 85°C without RTC Battery
	Humidity	Operating: 5 to 90% RH Storage: 5 to 90% RH
	MTBF	[C246] 554,887 hrs @ 25°C; 312,271 hrs @ 45°C ; 193,870 hrs @ 60°C [Q370] 596,170 hrs @ 25°C; 341,995 hrs @ 45°C ; 213,835 hrs @ 60°C ; 182,033 hrs @ 65°C Calculation Model: Telcordia Issue 4 Environment: GB, GC - Ground Benign, Controlled
MECHANISM	Dimensions	microATX Form Factor: 244mm (9.6") x 244mm (9.6")
	Height	PCB: 1.6mm Top Side: 38.5mm, Bottom Side: 4.4mm



► Block Diagram

CS332-C246

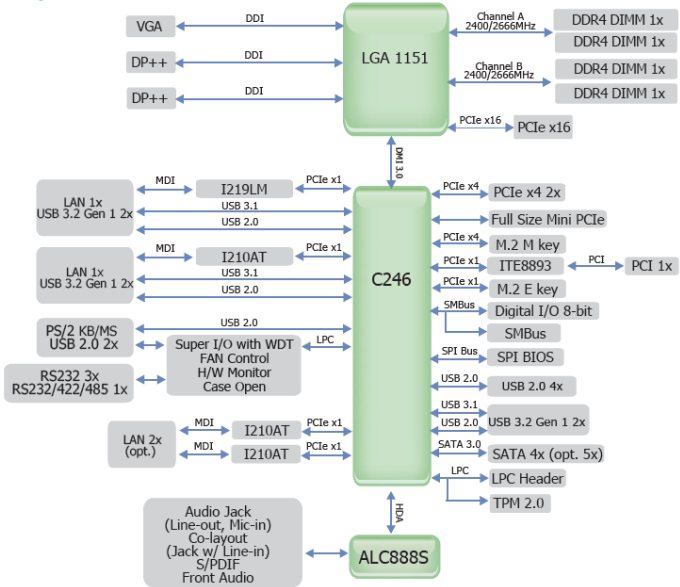

► Dimension

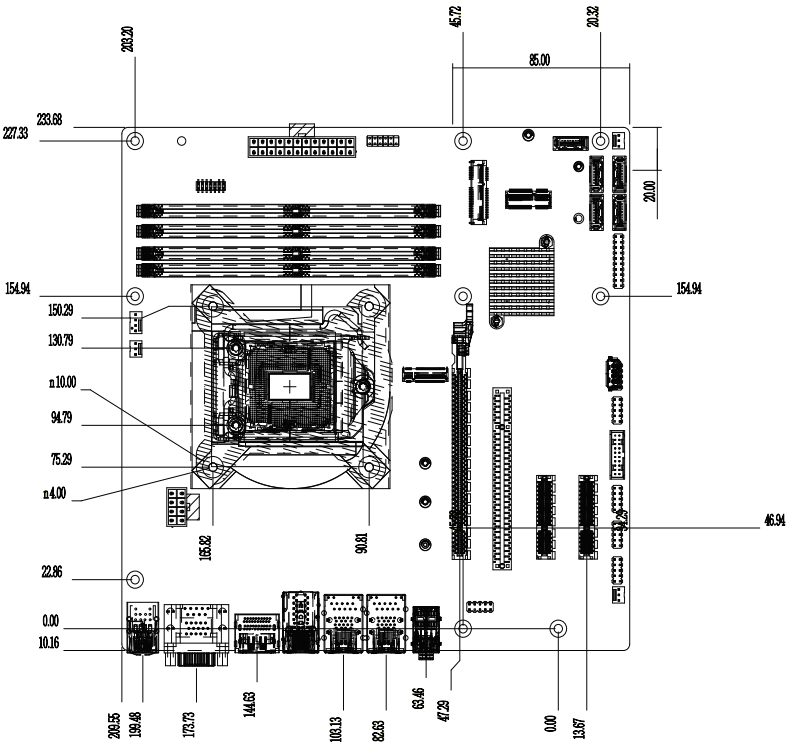

CS332-Q370

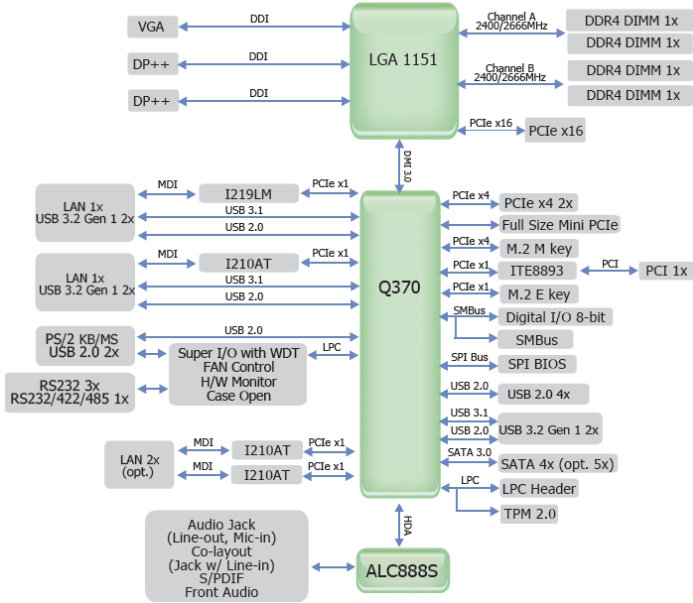

# Chapter 2 - Hardware Installation

## ► Board Layout

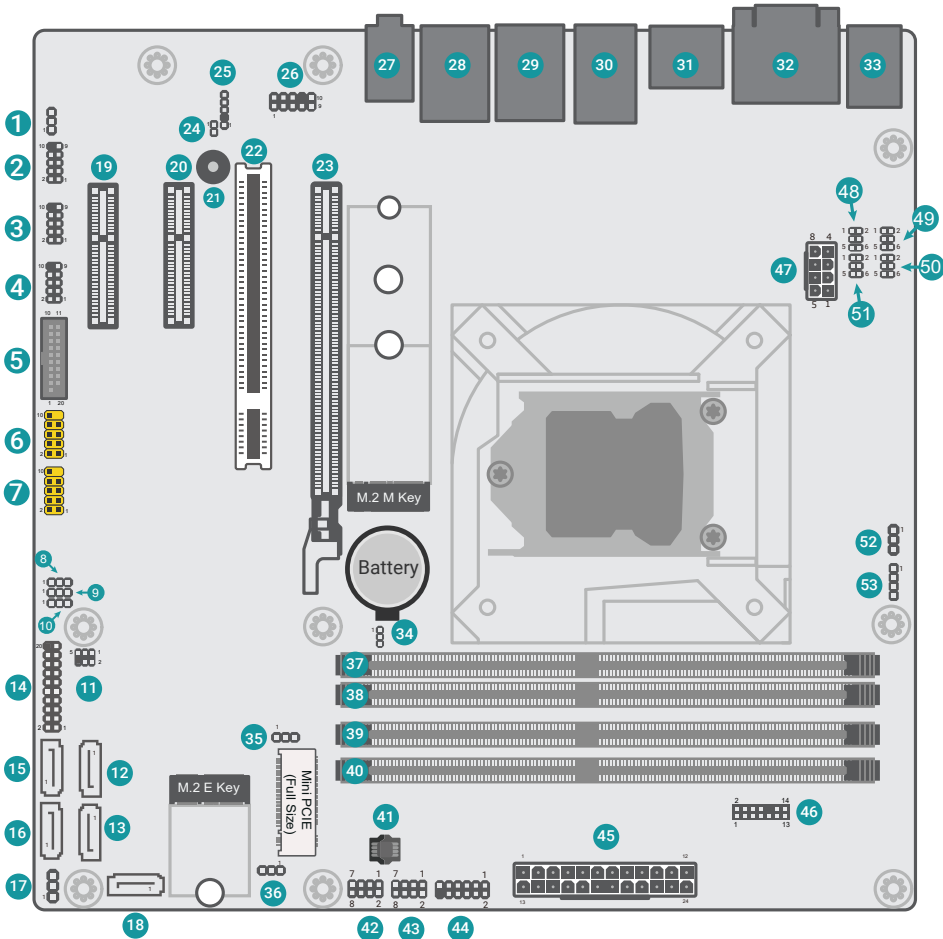

- |    |                                       |    |   |
|----|---------------------------------------|----|---|
| 1  | System Fan3                           | 21 | Buzzer                                    |
| 2  | COM2                                  | 22 | PCI1                                      |
| 3  | COM3                                  | 23 | PCIE1                                     |
| 4  | COM4                                  | 24 | Chassis Intrusion                         |
| 5  | USB 5/6 (USB3.1 Gen1)                 | 25 | S/PDIF                                    |
| 6  | USB 9/10 (USB2.0)                     | 26 | Front Audio                               |
| 7  | USB 11/12 (USB2.0)                    | 27 | ▲Line-Out / Line-In (optional)<br>▼MIC-In |
| 8  | Digital I/O (DIO) Power Select (JP17) | 28 | ▲LAN2<br>▼USB 3/4 (USB3.1 Gen1)           |
| 9  | Digital I/O (DIO) Power Supply (JP19) | 29 | ▲LAN1<br>▼USB 1/2 (USB3.1 Gen1)           |
| 10 | Digital I/O (DIO) Power Supply (JP18) | 30 | ▲LAN3<br>▼LAN4                            |
| 11 | SMBus                                 | 31 | ▲DP++<br>▼DP++                            |
| 12 | SATA1 (R1)                            | 32 | ▲COM1<br>▼VGA                             |
| 13 | SATA2 (R2)                            | 33 | ▲PS/2 KB/MS<br>▼USB 2.0                   |
| 14 | DIO                                   | 34 | Clear CMOS                                |
| 15 | SATA3 (R1)                            | 35 | HSIO Signal Trace Selection               |
| 16 | SATA4 (R1)                            | 36 | Mini PCIe/mSATA select                    |
| 17 | System Fan2                           | 37 | DIMM1                                     |
| 18 | SATA0 (R5)                            | 38 | DIMM2                                     |
| 19 | PCIE3                                 | 39 | DIMM3                                     |
| 20 | PCIE2                                 | 40 | DIMM4                                     |

- 
- 41 SPI Flash BIOS

---

  - 42 LAN 3/4 LED

---

  - 43 LAN 1/2 LED

---

  - 44 Front Panel

---

  - 45 ATX Power

---

  - 46 LPC

---

  - 47 +12V Power

---

  - 48 COM 1 Serial Mode (JP2)

---

  - 49 COM 1 Serial Mode (JP1)

---

  - 50 COM 1 RS232 Power Select

---

  - 51 COM 1 Serial Mode (JP3)

---

  - 52 System Fan1

---

  - 53 CPU Fan
-

► Installing the heat sink

Installing the Heat Sink

The CPU must be kept cool by using a heat sink, otherwise the CPU will overheat damaging both the CPU and system board.

1. Before you install the fan / heat sink, you must apply a thermal paste onto the top of the CPU. The thermal paste is usually supplied when you purchase the fan / heat sink assembly. Do not spread the paste all over the surface. When you later place the heat sink on top of the CPU, the compound will disperse evenly.

Some heat sinks come with a patch of preapplied thermal paste. Do not apply thermal paste if the fan / heat sink already has a patch of thermal paste on its underside. Peel the strip that covers the paste before you place the fan / heat sink on top of the CPU.

2. Place the heat sink on top of the CPU. The 4 spring screws around the heat sink, which are used to secure the heat sink onto the system board, must match the 4 mounting holes around the board.
3. Screw tight two of the spring screws at opposite corners into the mounting holes. And then proceed with the other two spring screws.

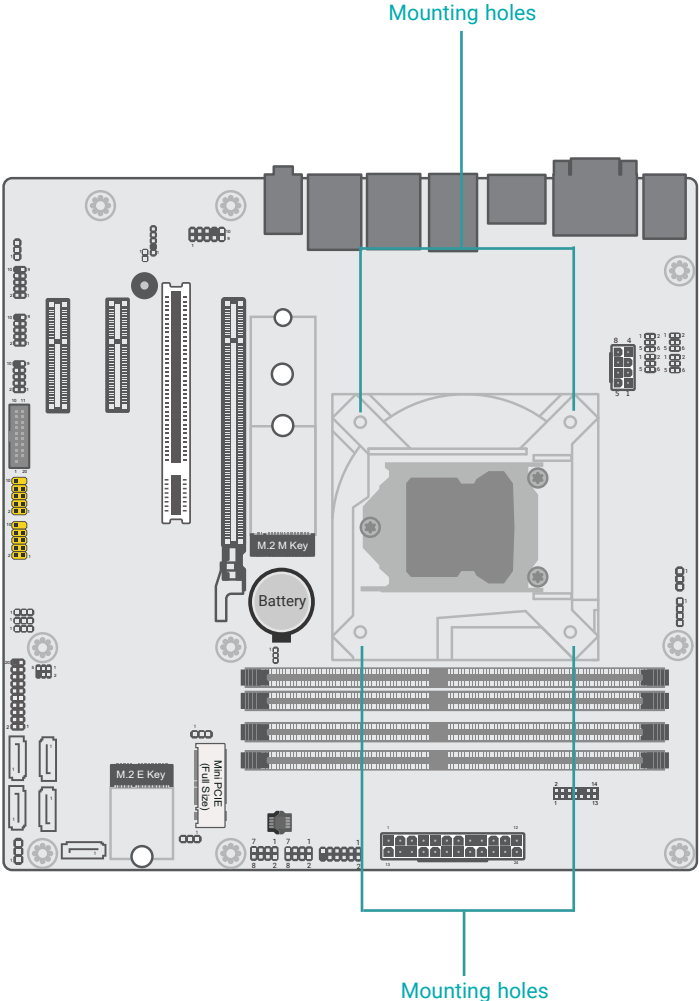

► Jumper Settings

Digital I/O (DIO) Power Select (JP17)

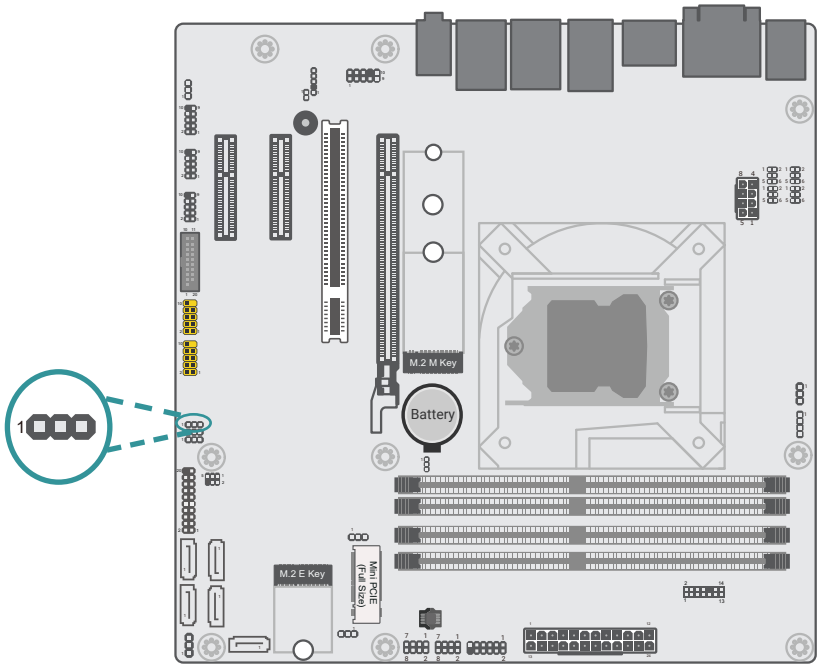

■ 1-2 On: +5VDU (default)

■ 2-3 On: +5V

Digital I/O (DIO) Power Supply (JP18 & JP19)

- JP18 is used to select for DIO0~DIO3.
- JP19 is used to select for DIO4~DIO7.

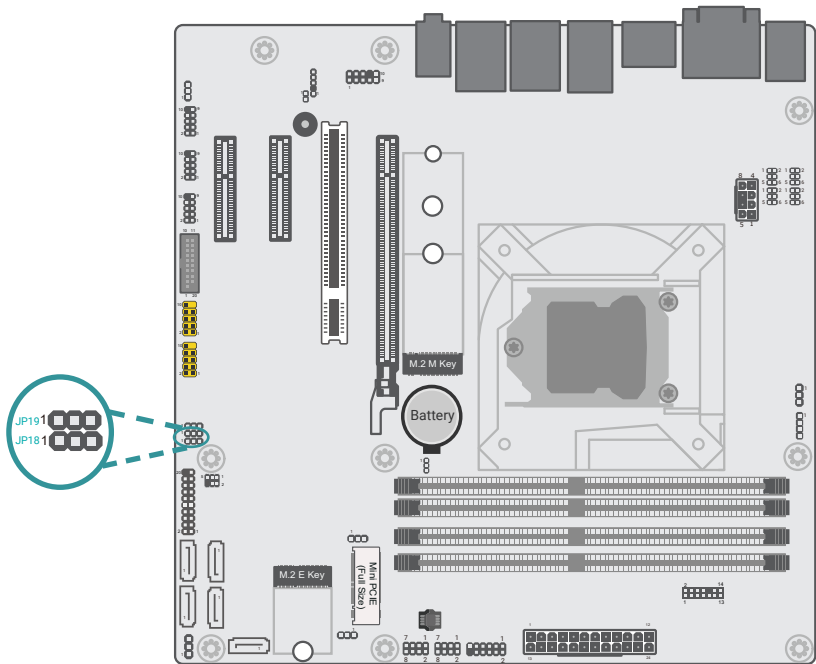

■ 1-2 On: DIO power used (default)

■ 2-3 On: GND

COM 1 Serial Mode (JP1, JP2, JP3)

COM 1 RS232 Power Select (JP4)

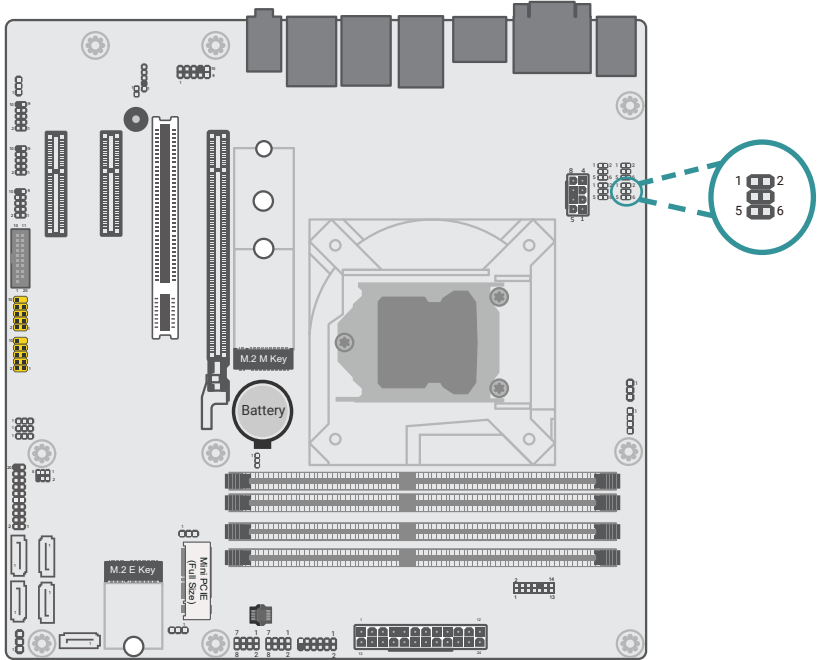
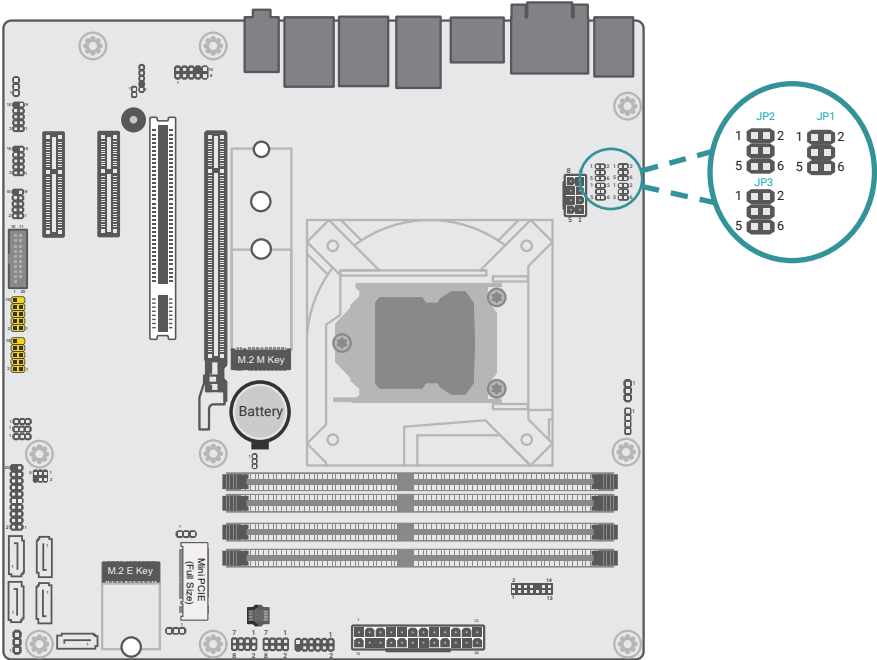

	RS232 (default)	RS422	RS485
JP3	<p>■ 1-3, 4-6 On</p>	<p>■ 3-5, 4-6 On</p>	<p>■ 3-5, 2-4 On</p>
JP1 & JP2	<p>■ 1-3, 2-4 On</p>	<p>■ 3-5, 4-6 On</p>	<p>■ 3-5, 4-6 On</p>

Standard RS232 (default)	RS232 with Power
<p>■ 2-4 On: Pin 1 = DCD-</p> <p>■ 1-3 On: Pin 9 = RI-</p>	<p>■ 4-6 On: Pin 1 = +12V</p> <p>■ 3-5 On: Pin 9 = +5V</p>

Clear CMOS (JP5)

HSIO Signal Trace Selection (JP20)

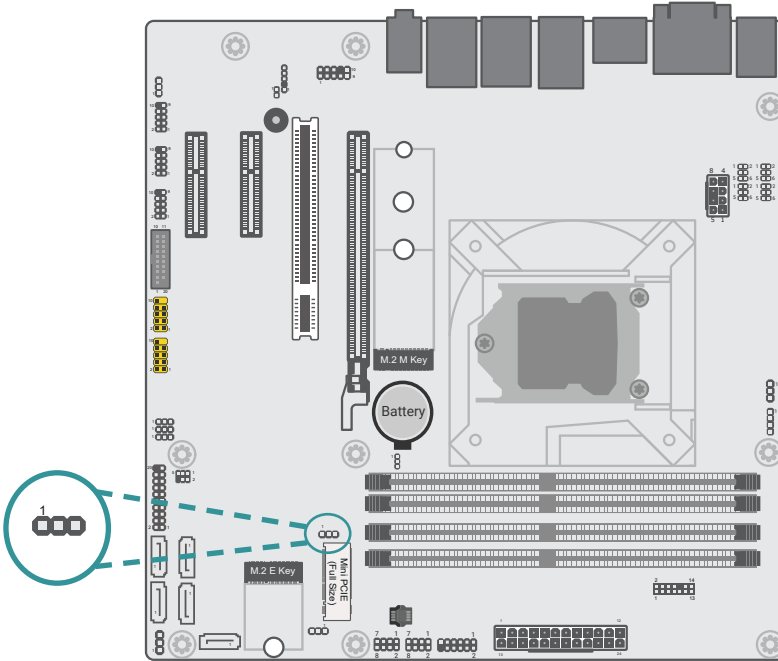
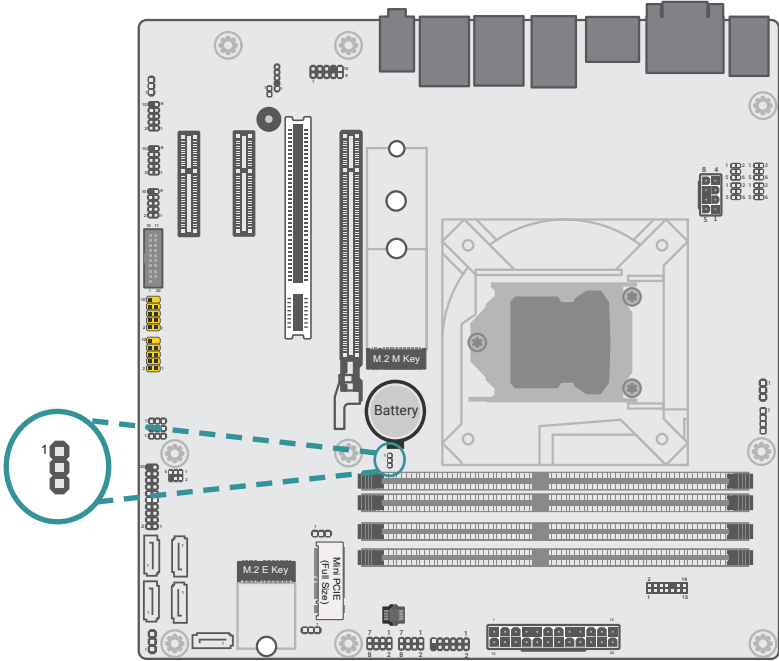

■ 1-2 On: Normal (default)



■ 2-3 On: Clear CMOS



■ 1-2 On: To CN10 (default)



■ 2-3 On: To J20

### Mini PCIe/mSATA Select (JP9)

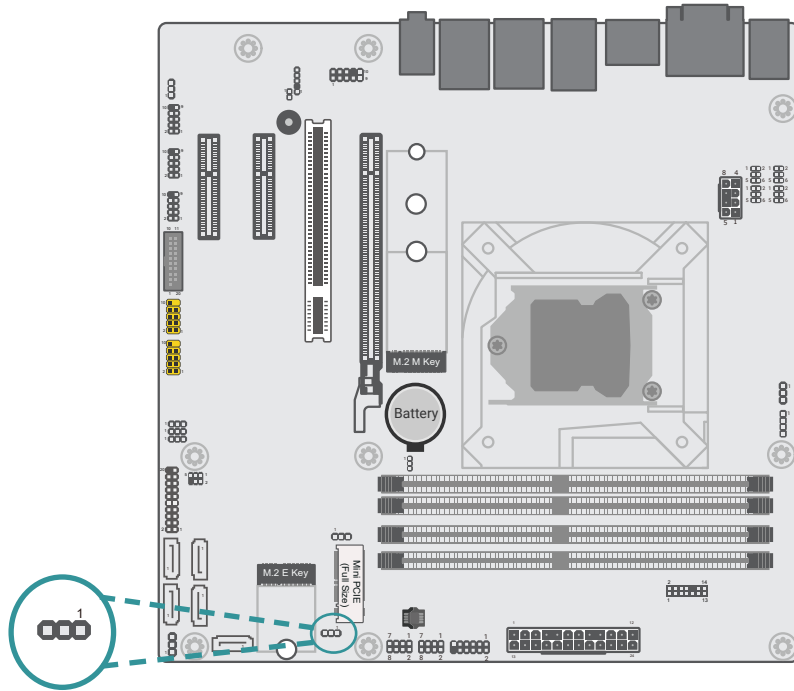

■ 1-2 On: Mini PCIe (default)



■ 2-3 On: mSATA



► Pin Assignment

SMBus (J12)

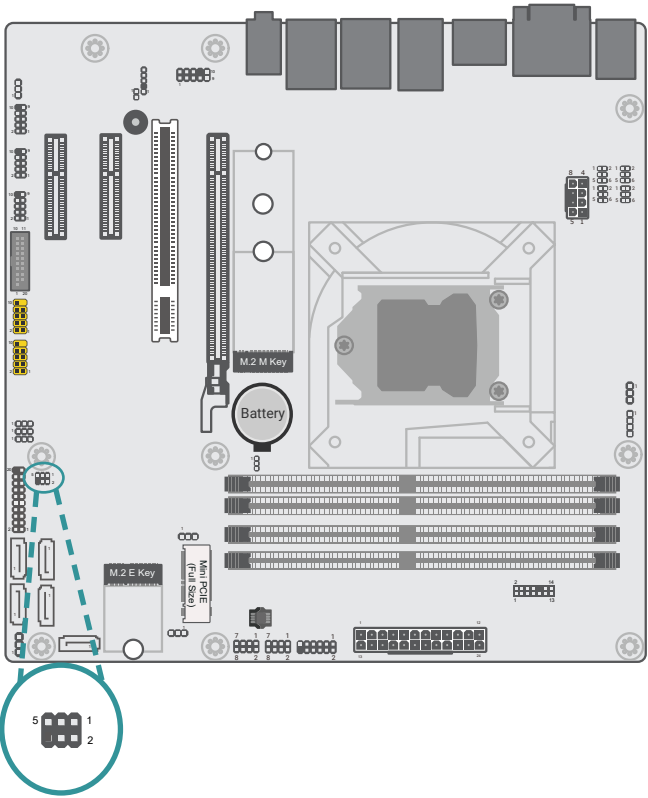

Pin	Assignment	Pin	Assignment
-----	------------	-----	------------

1	3V3SB	2	GND
3	SMBus_Clock	4	SMBus_DATA
5	SMBus_Alert	6	---

Front Panel (J18)

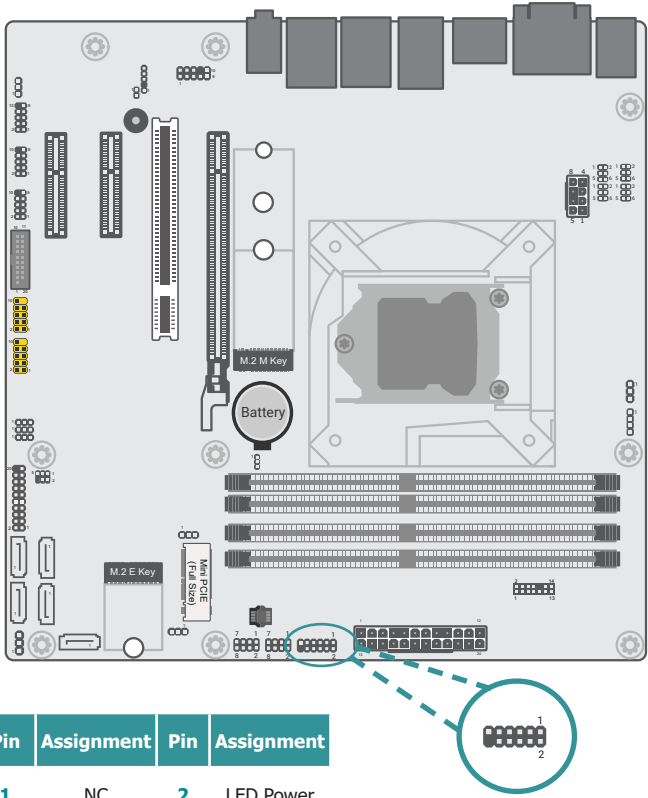

Pin	Assignment	Pin	Assignment
-----	------------	-----	------------

1	NC	2	LED Power
3	HDD Power	4	LED Power
5	Signal	6	Signal
7	GND	8	GND
9	Signal	10	Signal
11	NC	12	---

Chassis Intrusion (J14)

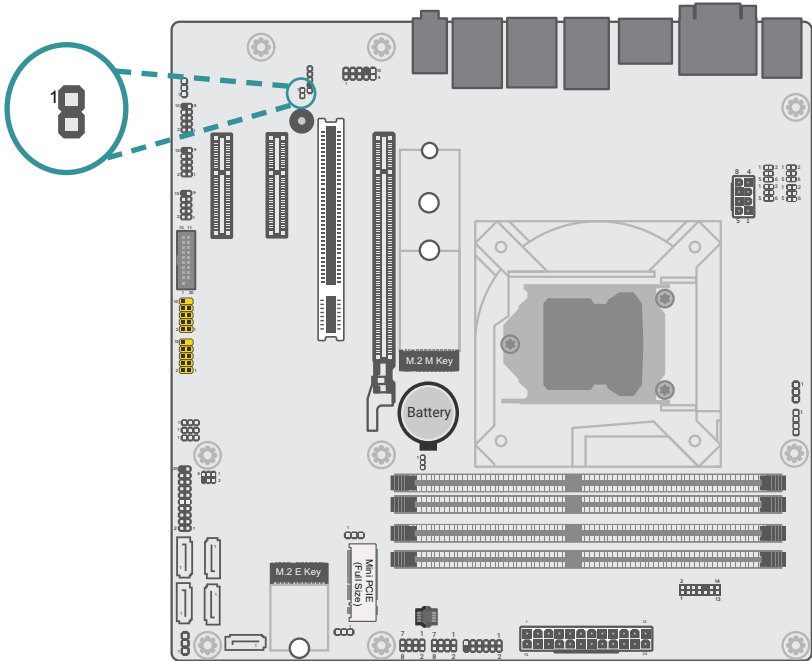

Pin	Assignment
1	Signal
2	GND

Digital I/O (J26)

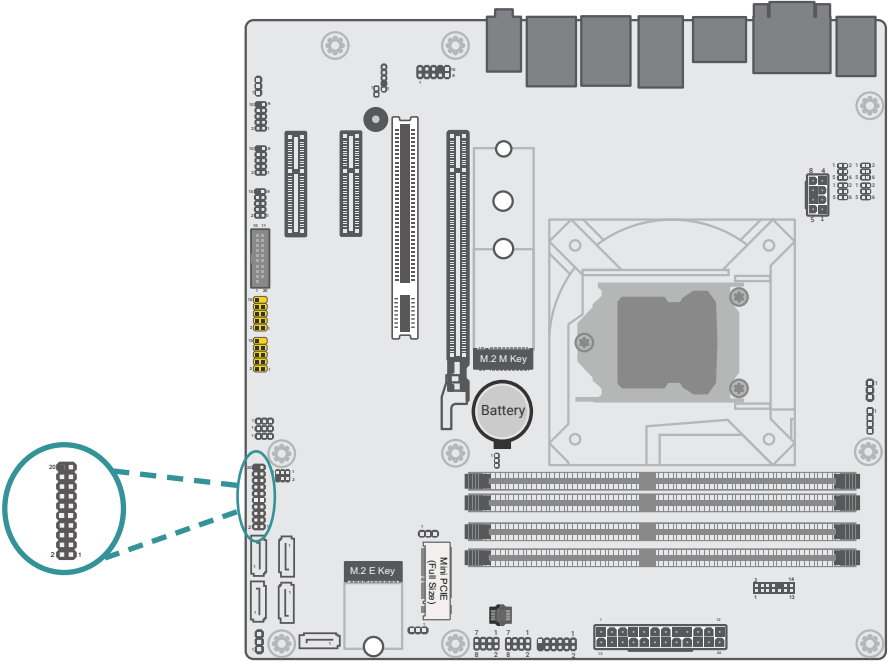

Pin	Assignment	Pin	Assignment
1	GND	2	+12V
3	DIO_7	4	+12V
5	DIO_6	6	GND
7	DIO_5	8	+5V
9	DIO_4	10	+5V
11	DIO_3	12	GND
13	DIO_2	14	+5V <sub>DU</sub>
15	DIO_1	16	+5V <sub>DU</sub>
17	DIO_0	18	GND
19	GND	20	---

SYSTEM FAN1/2/3 ( J7 & J22 & J30 )

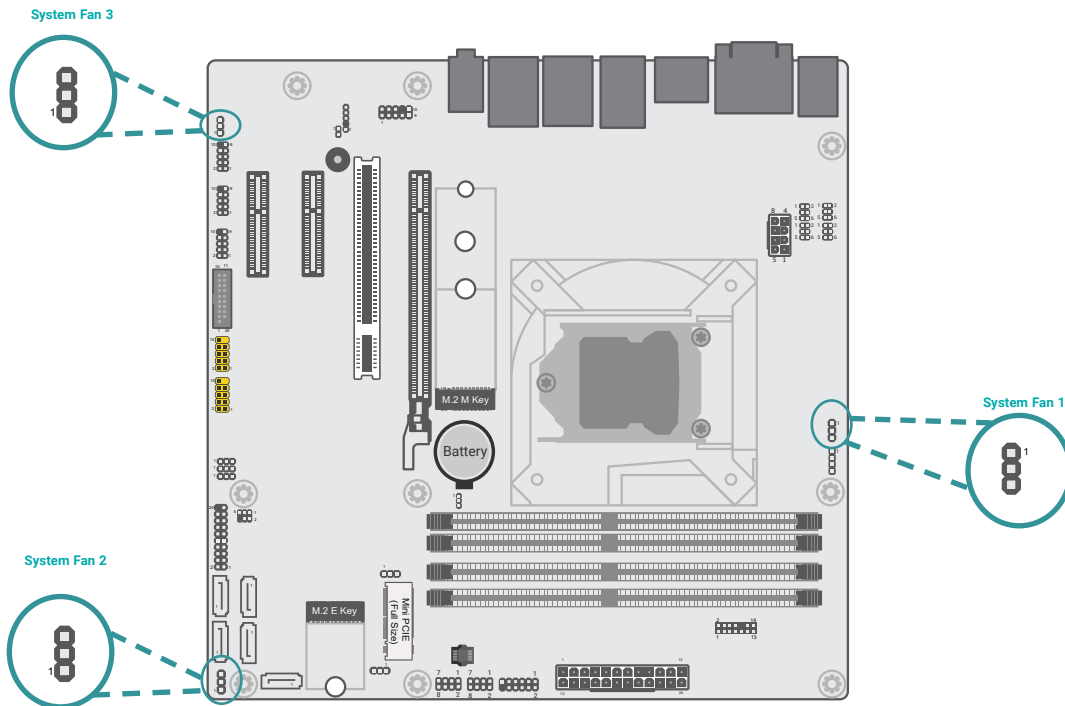

CPU FAN (J8)

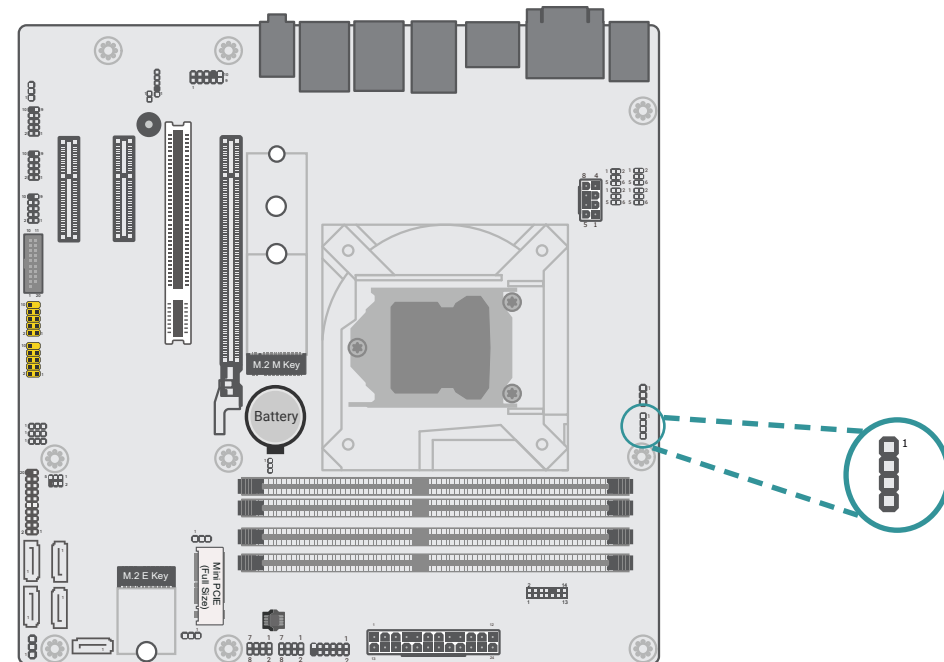

Pin	Assignment
-----	------------

- 1 GND
- 2 PWM
- 3 TACH

Pin	Assignment
-----	------------

- 1 GND
- 2 Power
- 3 Sense
- 4 Speed Control

SATA0, 1, 2, 3, 4 (J28 & J23 & J17 & J25 & J27)

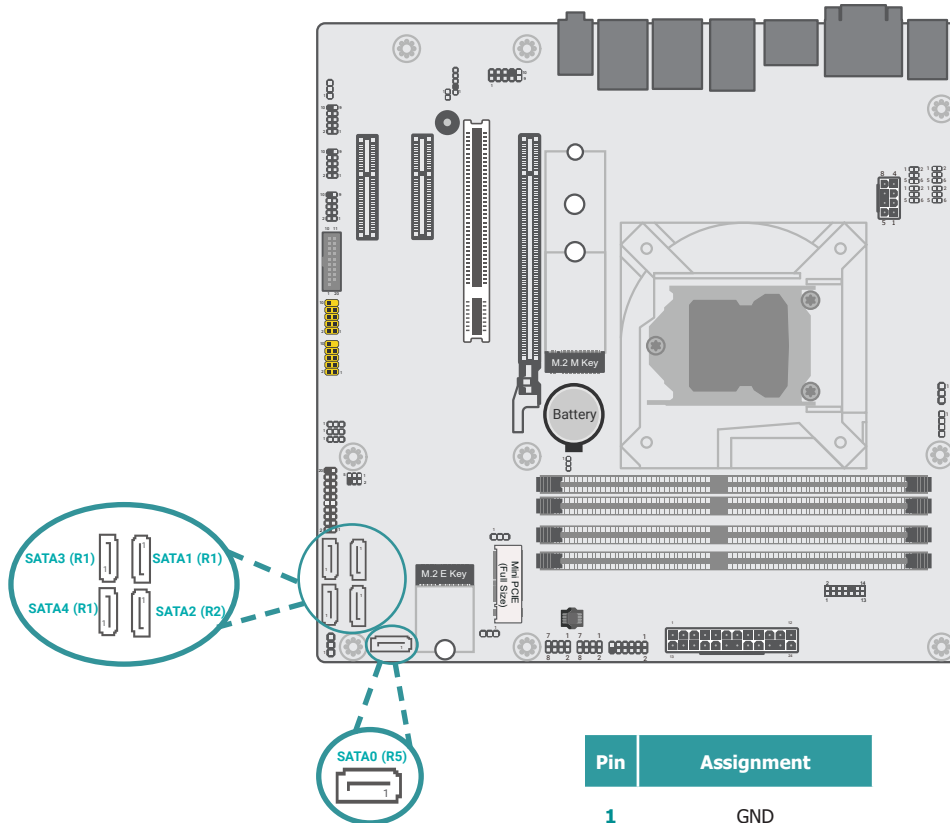

Pin	Assignment
1	GND
2	TX+
3	TX-
4	GND
5	RX-
6	RX+
7	GND

LAN 1/2 LED & LAN 3/4 LED ( J19 & J31)

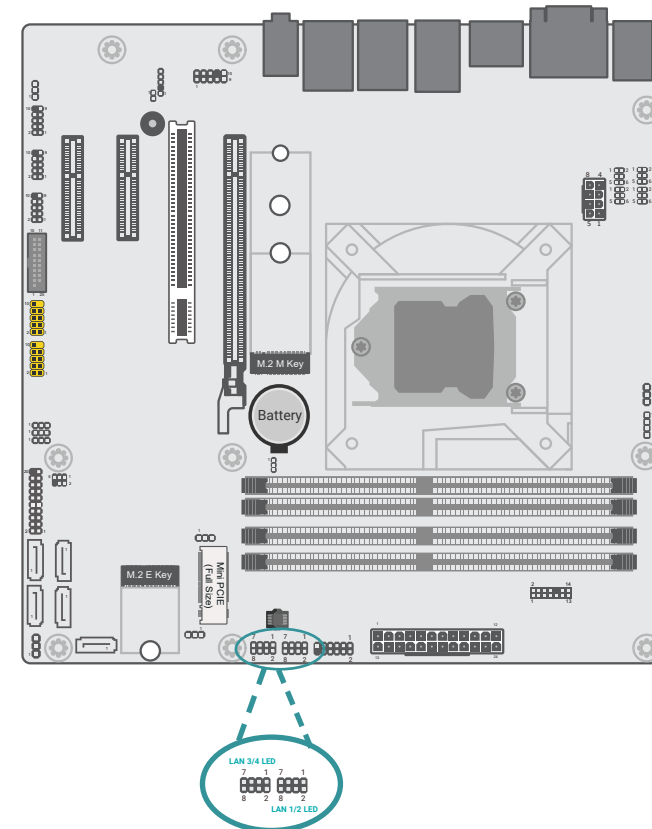

Pin	Assignment	Pin	Assignment
1	GBE(LAN1/3)_1000	2	GBE(LAN1/3)_100
3	GBE(LAN1/3)_LED_LINK_ACT	4	3V3DU
5	LINK(LAN2/4)_1000	6	LINK(LAN2/4)_100
7	LINK(LAN2/4)_ACTIVITY	8	3V3DU

LPC (J21)

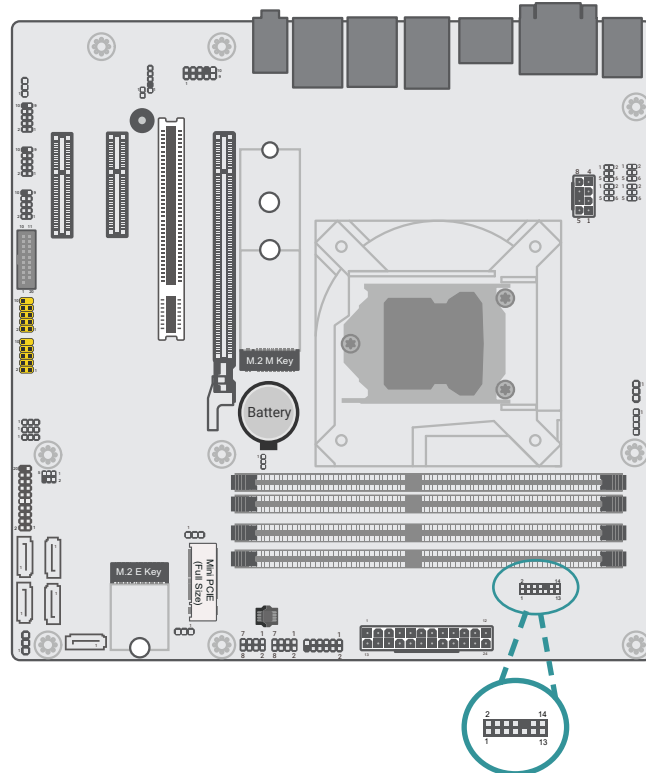

Pin	Assignment	Pin	Assignment
1	L_CLK	2	L_LAD1
3	L_RST#	4	L_LAD0
5	L_FRAME#	6	3.3V
7	L_LAD3	8	GND
9	L_LAD2	10	---
11	SERIRQ	12	GND
13	5VSB	14	5V

S/PDIF ( J1)

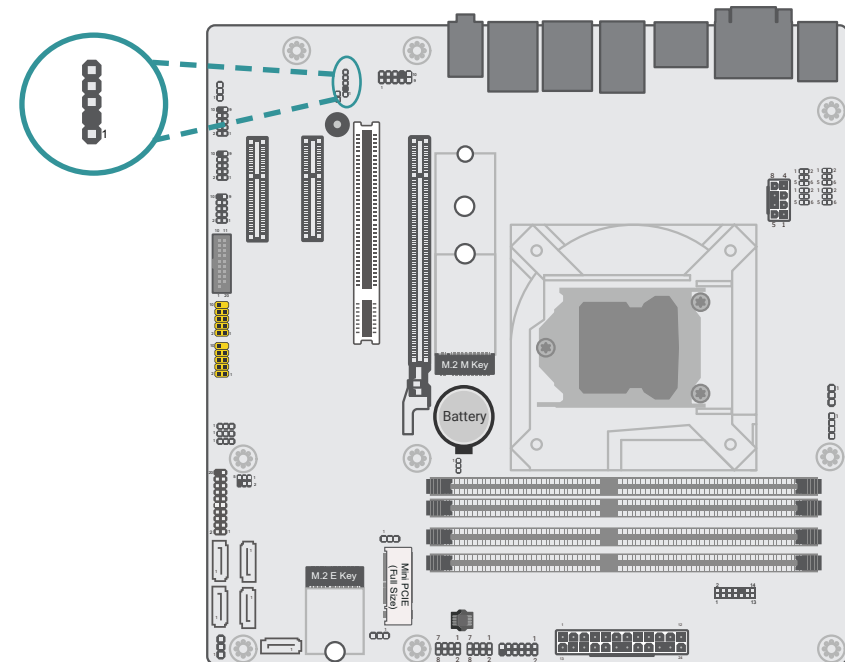

Pin	Assignment
1	+5V
2	---
3	SPDIF Out
4	GND
5	SPDIF In

Front Audio ( J2)

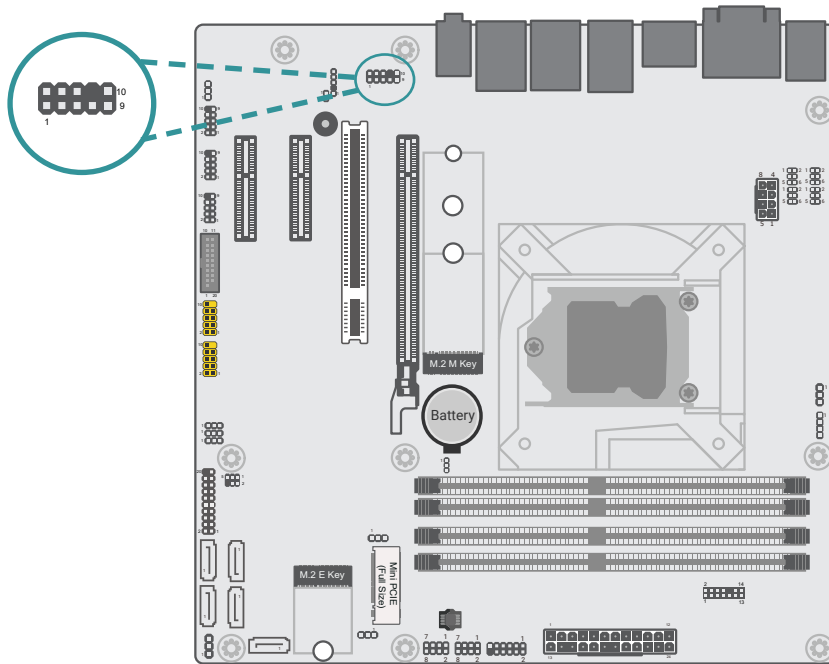

Pin	Assignment	Pin	Assignment
1	Mic-L	2	GND
3	Mic-R	4	N.C.
5	Line-Out-R	6	Mic-JD (sense)
7	GND	8	KEY
9	Line-Out-L	10	Line-JD (sense)

► **System Memory**

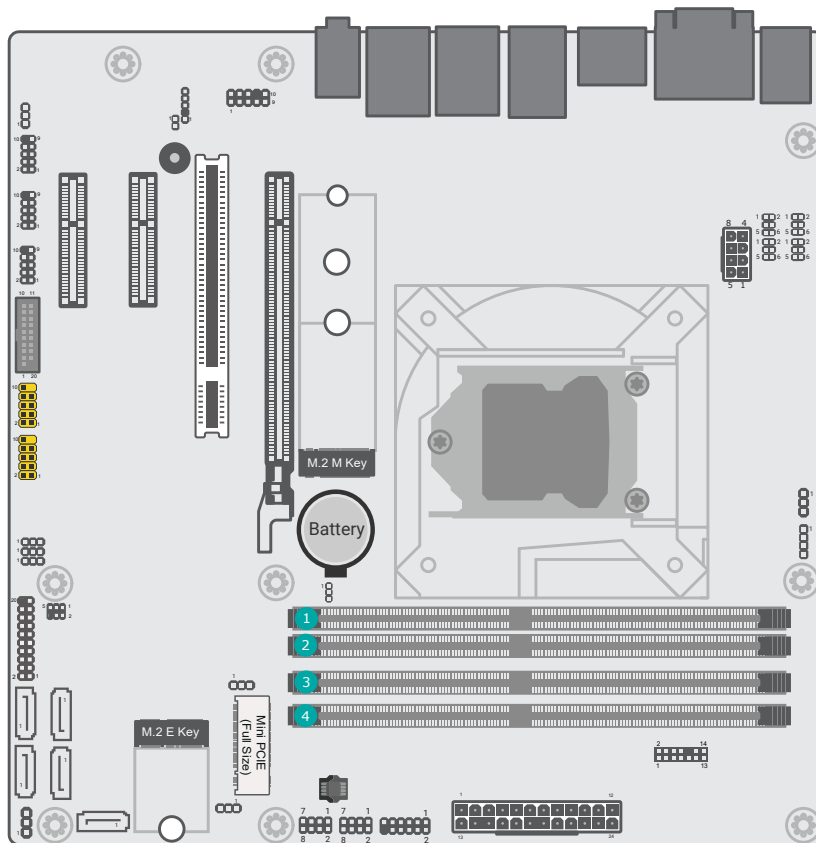

- 1 DIMM1

---

- 2 DIMM2

---

- 3 DIMM3

---

- 4 DIMM4

---

**Installing the DIMM Module**

Before installing the memory module, please make sure that the following safety cautions are well-attended.

1. Make sure the PC and all other peripheral devices connected to it has been powered down.
2. Disconnect all power cords and cables.
3. Locate the DIMM socket on the system board
4. Make sure the notch on memory card is aligned to the key on the socket.

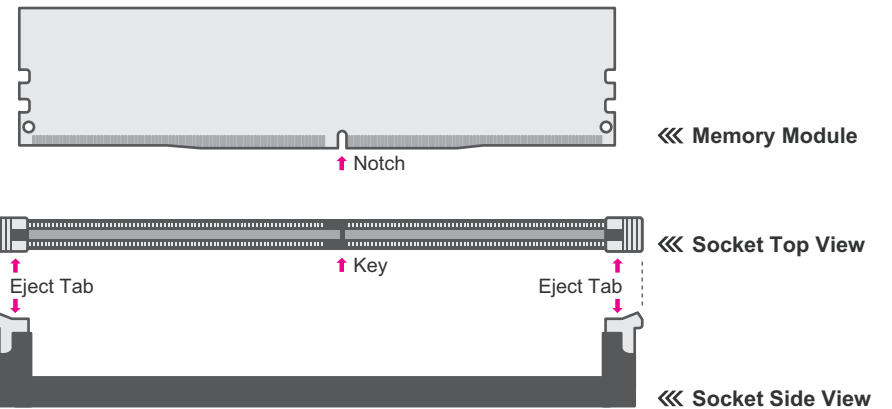

The system board supports the following memory interface.

**Single Channel (SC)**

Data will be accessed in chunks of 64 bits from the memory channels. DIMMs are on the same channel. DIMMs in a channel can be identical or completely different. However, we highly recommend using identical DIMMs. Not all slots need to be populated.

**Dual Channel (DC)**

Data will be accessed in chunks of 128 bits from the memory channels. Dual channel provides better system performance because it doubles the data transfer rate.

## ► Expansion Slots

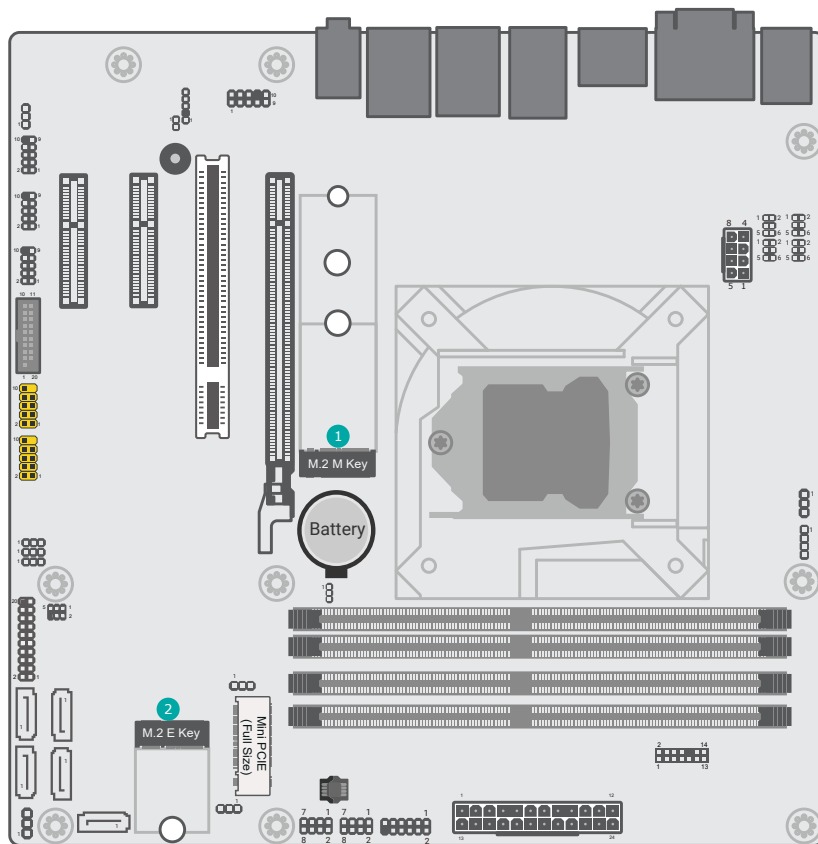

1 M.2 M-Key

2 M.2 E-Key

### Installing the M.2 Module

Before installing the M.2 module into the M.2 socket, please make sure that the following safety cautions are well-attended.

1. Make sure the PC and all other peripheral devices connected to it has been powered down.
2. Disconnect all power cords and cables.
3. Locate the M.2 socket on the system board
4. Make sure the notch on card is aligned to the key on the socket.
5. Make sure the standoff screw is removed from the standoff.

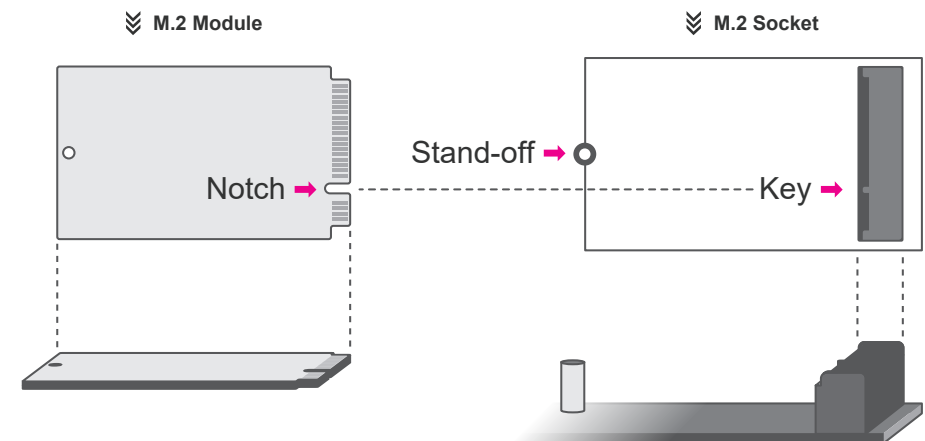



Please follow the steps below to install the card into the socket.

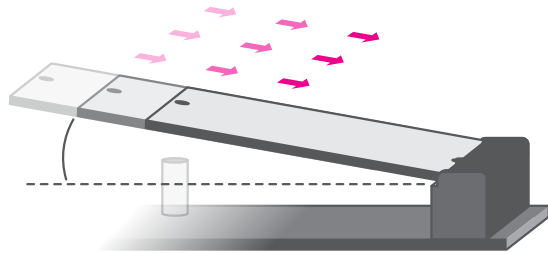

**Step 1:**  
Insert the card into the socket at an angle while making sure the notch and key are perfectly aligned.

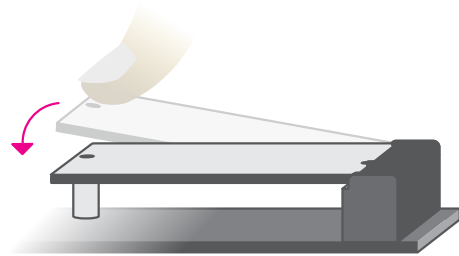

**Step 2:**  
Press the end of the card far from the socket down until against the stand-off.

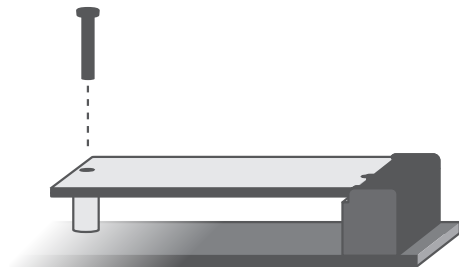

**Step 3:**  
Screw tight the card onto the stand-off with a screw driver and a stand-off screw until the gap between the card and the stand-off closes up. The card should be lying parallel to the board when it's correctly mounted.

## Chapter 3 - BIOS Settings

### ► Overview

The BIOS is a program that takes care of the basic level of communication between the CPU and peripherals. It contains codes for various advanced features found in this system board. The BIOS allows you to configure the system and save the configuration in a battery-backed CMOS so that the data retains even when the power is off. In general, the information stored in the CMOS RAM of the EEPROM will stay unchanged unless a configuration change has been made such as a hard drive replaced or a device added. It is possible that the CMOS battery will fail causing CMOS data loss. If this happens, you need to install a new CMOS battery and reconfigure the BIOS settings.



#### Note:

The BIOS is constantly updated to improve the performance of the system board; therefore the BIOS screens in this chapter may not appear the same as the actual one. These screens are for reference purpose only.

#### Default Configuration

Most of the configuration settings are either predefined according to the Load Optimal Defaults settings which are stored in the BIOS or are automatically detected and configured without requiring any actions. There are a few settings that you may need to change depending on your system configuration.

#### Entering the BIOS Setup Utility

The BIOS Setup Utility can only be operated from the keyboard and all commands are keyboard commands. The commands are available at the right side of each setup screen.

The BIOS Setup Utility does not require an operating system to run. After you power up the system, the BIOS message appears on the screen and the memory count begins. After the memory test, the message "Press DEL to run setup" will appear on the screen. If the message disappears before you respond, restart the system or press the "Reset" button. You may also restart the system by pressing the <Ctrl> <Alt> and <Del> keys simultaneously.

#### Legends

Keys	Function
Right / Left arrow	Move the highlight left or right to select a menu
Up / Down arrow	Move the highlight up or down between submenus or fields
<Enter>	Enter the highlighted submenu
+ (plus key)/F6	Scroll forward through the values or options of the highlighted field
- (minus key)/F5	Scroll backward through the values or options of the highlighted field
<F1>	Display general help
<F2>	Display previous values
<F7>	Popup Boot Device List
<F9>	Optimized defaults
<F10>	Save and Exit
<Esc>	Return to previous menu

#### Scroll Bar

When a scroll bar appears to the right of the setup screen, it indicates that there are more available fields not shown on the screen. Use the up and down arrow keys to scroll through all the available fields.

#### Submenu

When "►" appears on the left of a particular field, it indicates that a submenu which contains additional options are available for that field. To display the submenu, move the highlight to that field and press <Enter>.

► Main

The Main menu is the first screen that you will see when you enter the BIOS Setup Utility.

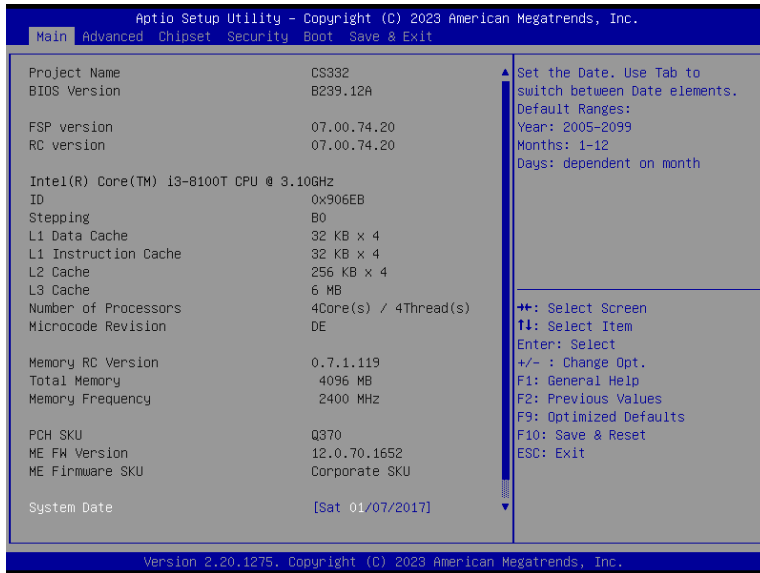

**System Date**

The date format is <month>, <date>, <year>. Press "Tab" to switch to the next field and press "-" or "+" to modify the value.

**System Time**

The time format is <hour>, <minute>, <second>. The time is based on the 24-hour military-time clock. For example, 1 p.m. is 13:00:00. Hour displays hours from 00 to 23. Minute displays minutes from 00 to 59. Second displays seconds from 00 to 59.

► Advanced

The Advanced menu allows you to configure your system for basic operation. Some entries are defaults required by the system board, while others, if enabled, will improve the performance of your system or let you set some features according to your preference.



**Important:**  
Setting incorrect field values may cause the system to malfunction.

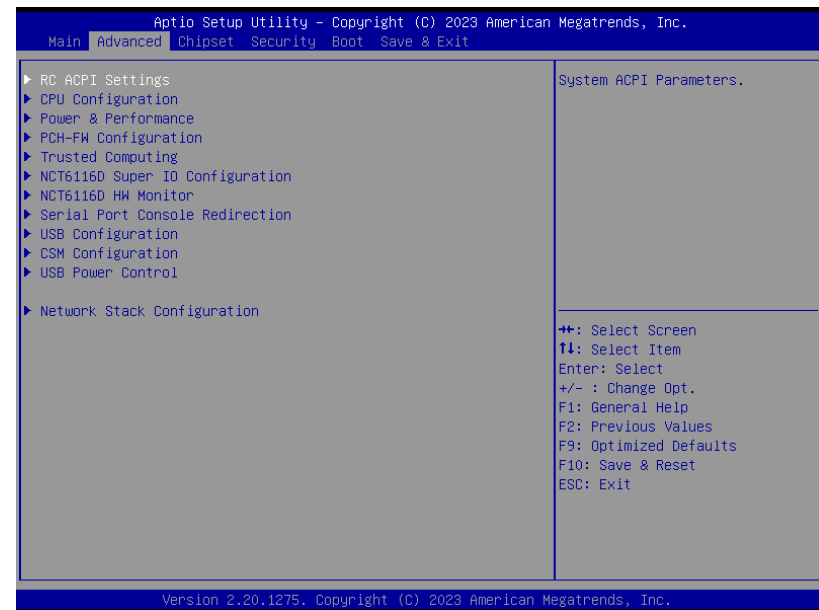

▶ Advanced

RC ACPI Settings

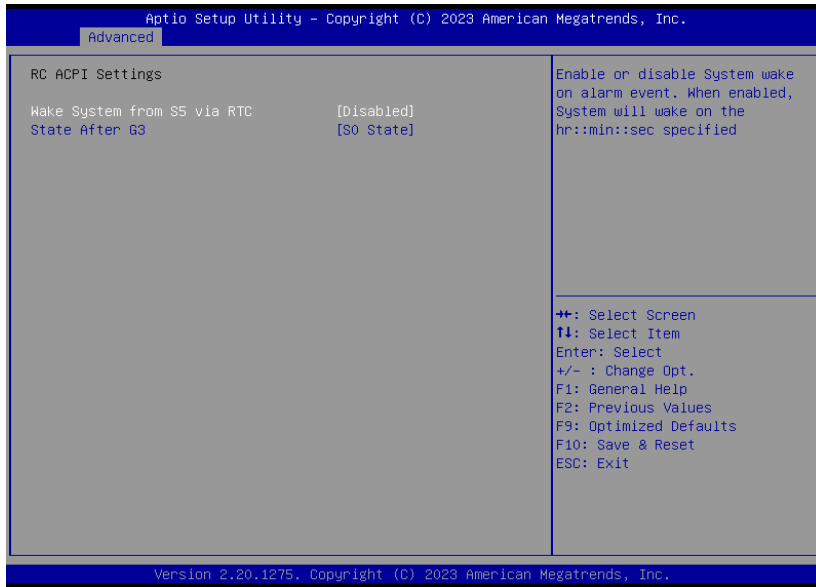

**Wake system from S5 via RTC**

When Enabled, the system will automatically power up at a designated time every day. Once it's switched to [Enabled], please set up the time of day – hour, minute, and second – for the system to wake up.

**State After G3**

Select between S0 State, and S5 State. This field is used to specify what state the system is set to return to when power is re-applied after a power failure (G3 state).

- **S0 State** The system automatically powers on after power failure.
- **S5 State** The system enter soft-off state after power failure. Power-on signal input is required to power up the system.
- **Last State** The system returns to the last state right before power failure.

▶ Advanced

CPU Configuration

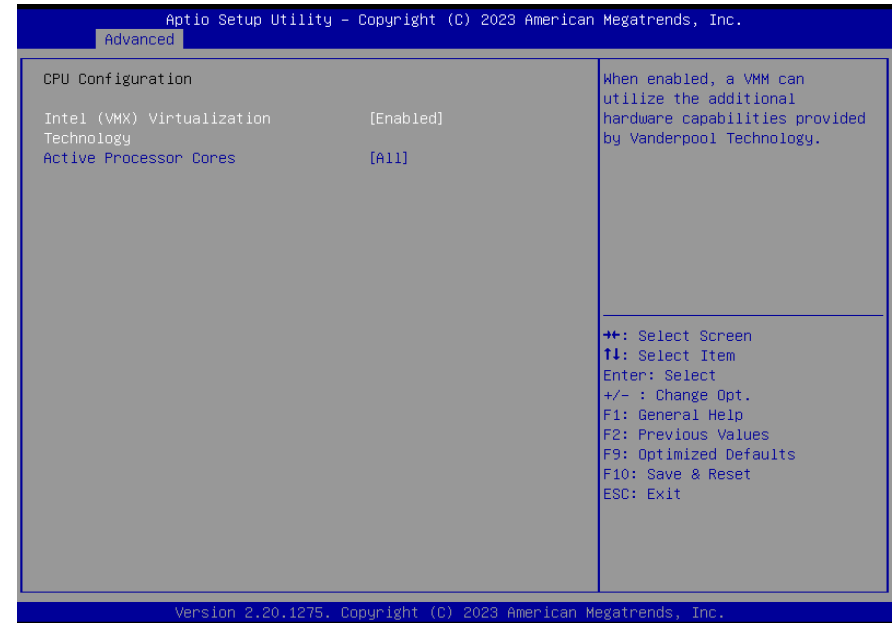

**Intel (VMX) Virtualization Technology**

When this field is set to Enabled, the VMM can utilize the additional hardware capabilities provided by Vanderpool Technology.

**Active Processor Cores**

Select number of cores to enable in each processor package.

▶ Advanced

Power & Performance

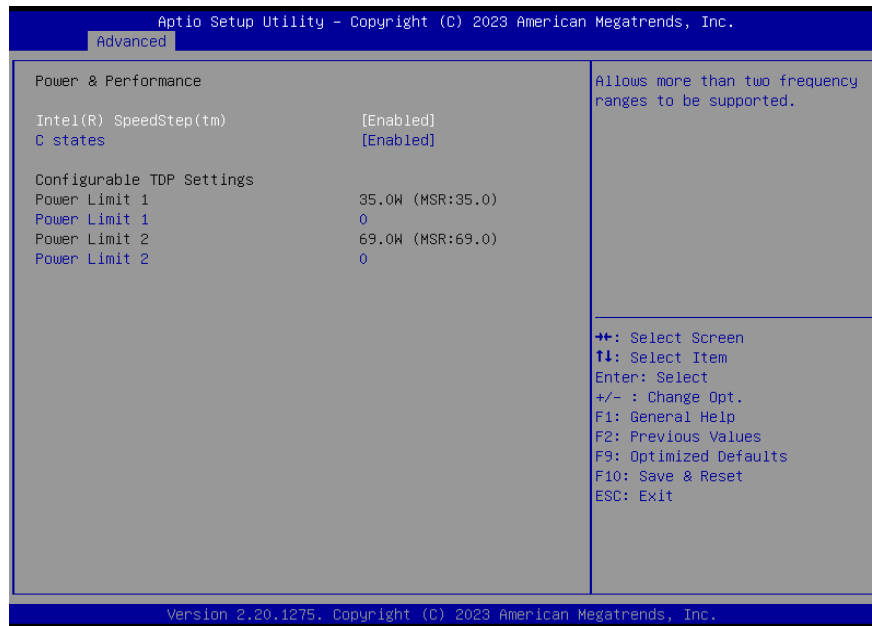

**Intel(R) SpeedStep(tm)**

This field is used to enable or disable the Intel SpeedStep® Technology, which helps optimize the balance between system’s power consumption and performance. After it is enabled in the BIOS, EIST features can then be enabled via the operating system’s power management.

**C states**

Enable or disable CPU Power Management. It allows CPU to enter "C states" when it’s idle and nothing is executing.

▶ Advanced

PCH-FW Configuration

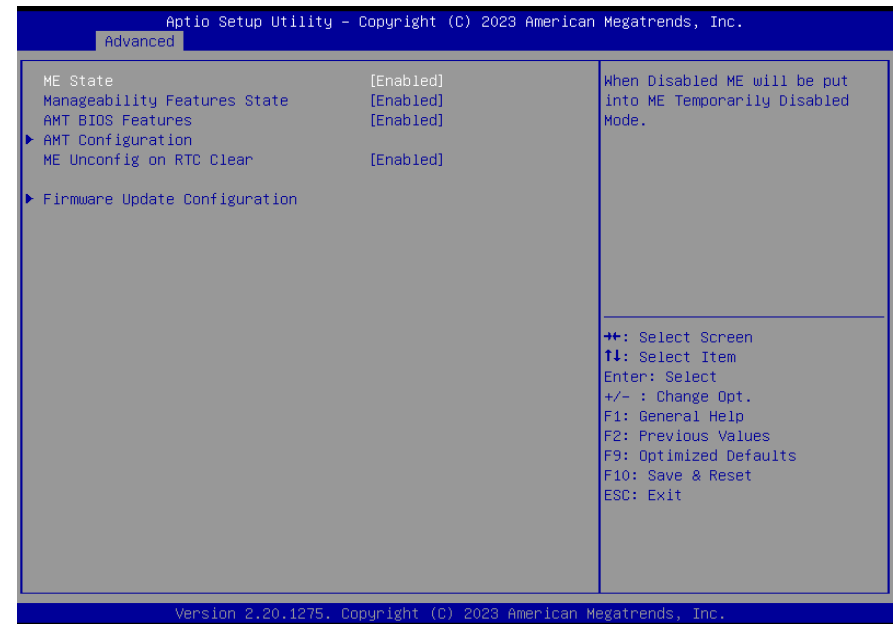

**ME State**

When this field is set to Disabled, ME will be put into ME Temporarily Disabled Mode.

**Manageability Features State**

Enable or disable Intel(R) Manageability features. This option disables/enables Manageability Features support in FW. To disable, support platform must be in an unprovisioned state first.

**AMT BIOS Features**

When disabled, AMT BIOS features are no longer supported and user is no longer able to access MEBx Setup. This option does not disable manageability features in FW.

**AMT Configuration**

Configure Intel(R) Active Management Technology Parameters.

**ME Unconfig on RTC Clear**

When disabled, ME will not be unconfigured on RTC Clear.

**Firmware Update Configuration**

Configure Management Engine Technology Parameters.

► Advanced

Trusted Computing

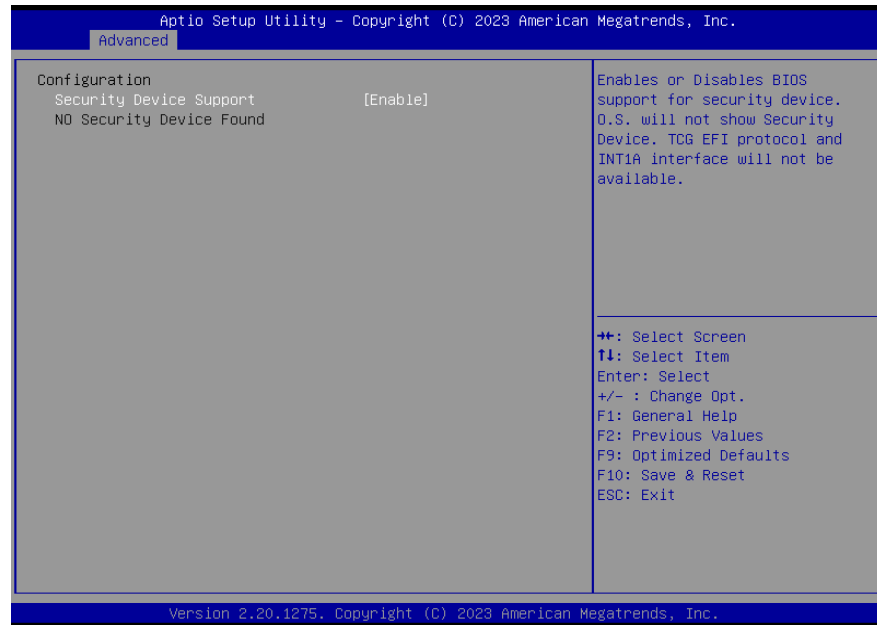

**Security Device Support**

This field is used to enable or disable BIOS support for the security device such as an TPM 2.0 to achieve hardware-level security via cryptographic keys.

► Advanced

NCT6116D Super IO Configuration

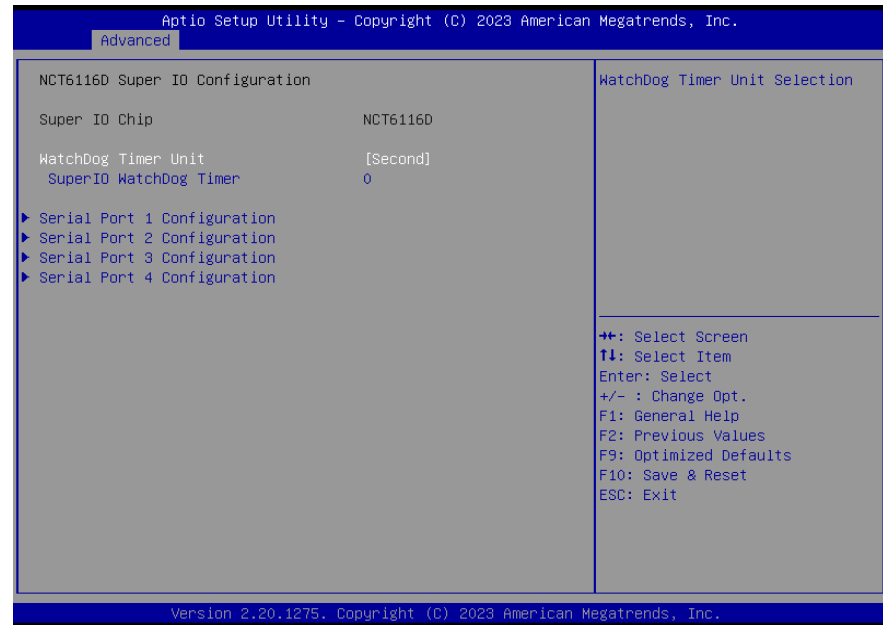

**WatchDog Timer Unit**

Select WatchDog Timer Unit – Second or Minute.

**SuperIO WatchDog Timer**

Set SuperIO WatchDog Timer Timeout value. The range is from 0 (disabled) to 255.

► **Advanced**

**NCT6116D Super IO Configuration ► Serial Port 1, 2 Configuration**

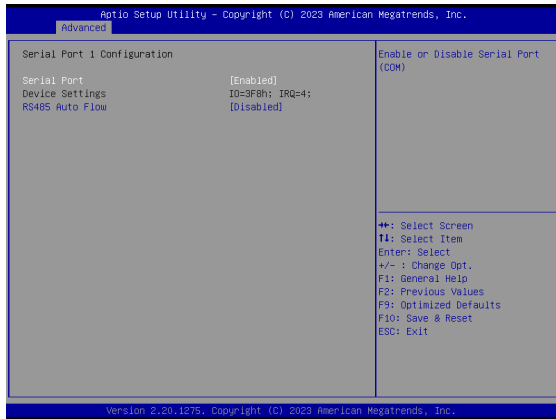

► **Advanced**

**NCT6116D Super IO Configuration ► Serial Port 3, 4 Configuration**

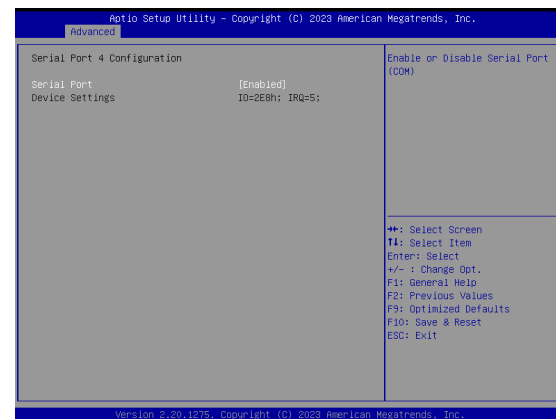
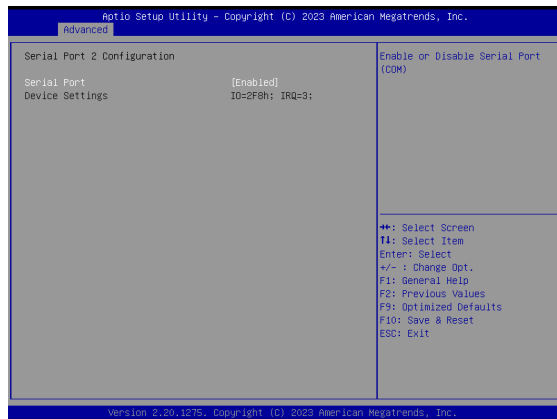
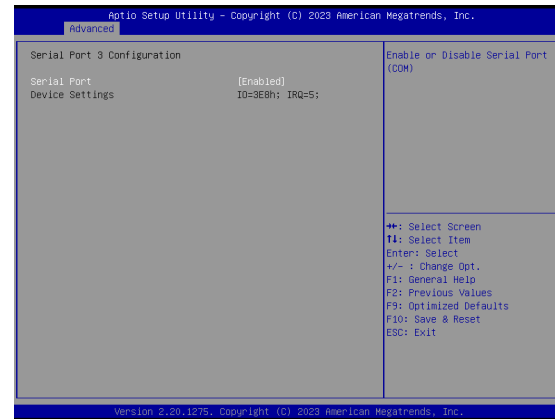

**Serial Port**  
 Enable or disable serial port.

**Serial Port**  
 Enable or disable serial port.

► Advanced

NCT6116D HW Monitor

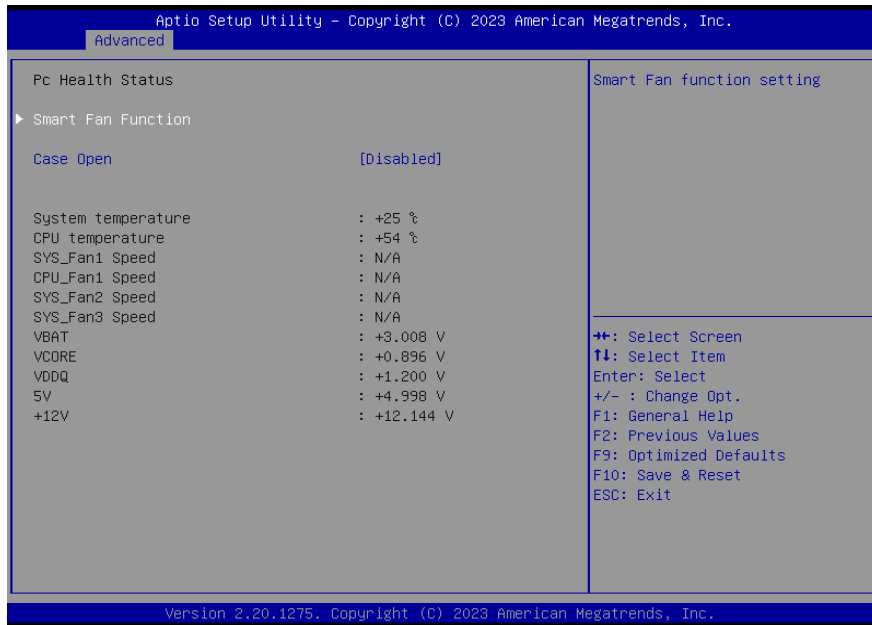

This section displays the system's health information, i.e. voltage readings, CPU and system temperatures, and fan speed readings

**Smart Fan Function**

Smart Fan Function Setting.

**Case Open**

Enable or disable the case open detection function.

► Advanced

NCT6116D HW Monitor ► Smart FAN Function

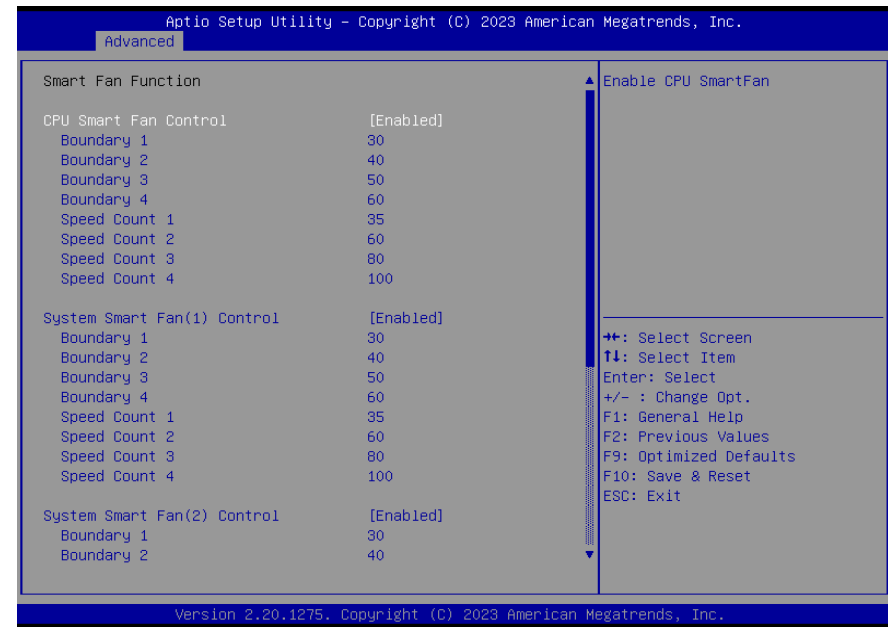

Smart Fan is a fan speed moderation strategy dependent on the current system temperature. When the system temperature goes higher than the Boundary setting, the fan speed will be turned up to the setting of the Fan Speed Count that bears the same index as the Boundary field.

**SYS Smart Fan/CPU Smart Fan Control = [Enabled]**

• **Boundary 1 to Boundary 4**

Set the boundary temperatures that determine the fan speeds accordingly, the value ranging from 0-127°C. For example, when the system temperature reaches Boundary 1 setting, the fan speed will be turned up to the designated speed of the Fan Speed Count 1 field.

• **Fan Speed Count 1 to Fan Speed Count 4**

Set the fan speed, the value ranging from 1-100%, 100% being full speed. The fans will operate according to the specified boundary temperatures above-mentioned.



▶ **Advanced**

**Serial Port Console Redirection**

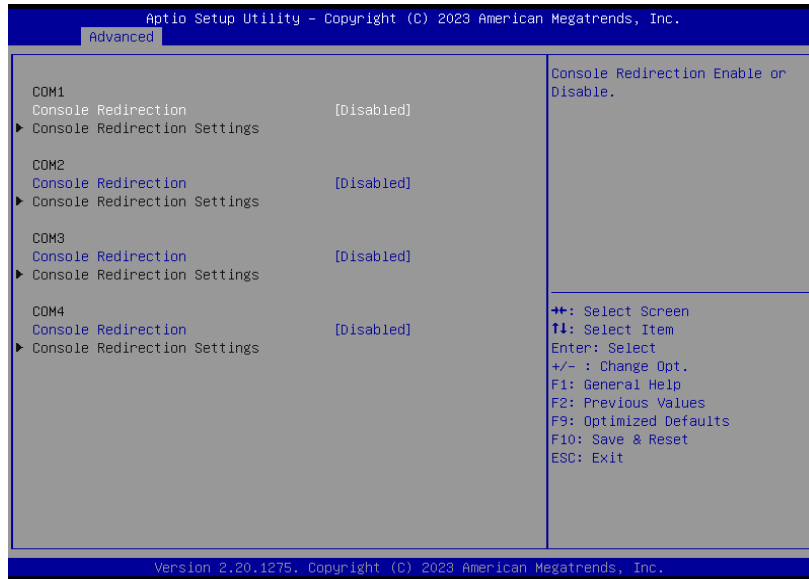

**Console Redirection**

By enabling Console Redirection of a COM port, the sub-menu of console redirection settings will become available for configuration as detailed in the following.

▶ **Advanced**

**Serial Port Console Redirection ▶ Console Redirection Settings**

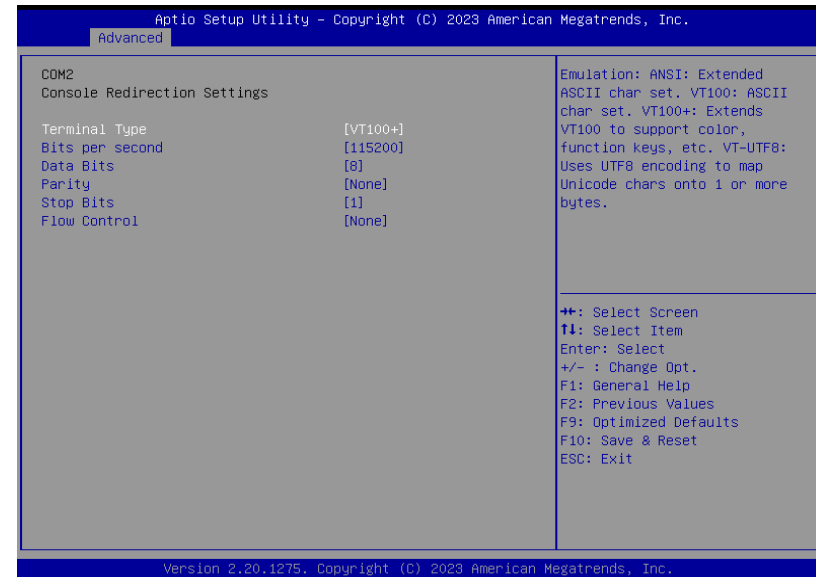
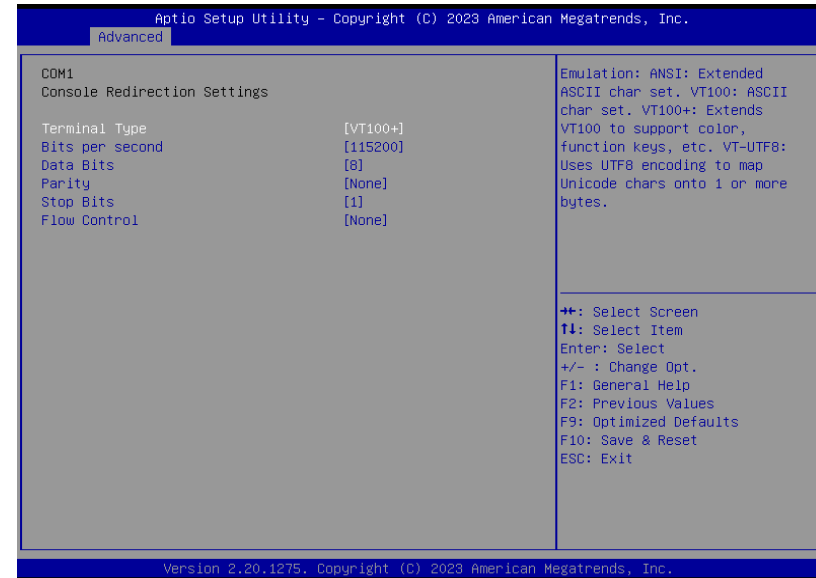

► **Advanced**

**Serial Port Console Redirection** ► **Console Redirection Settings**

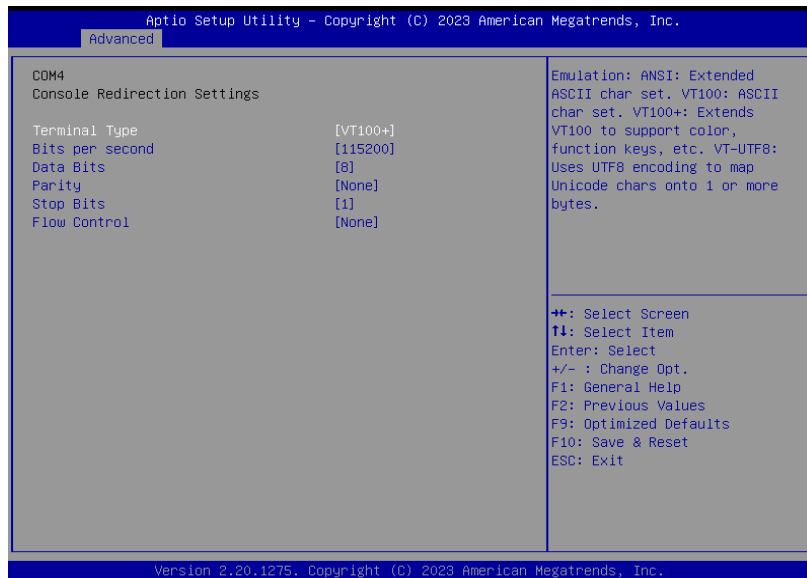
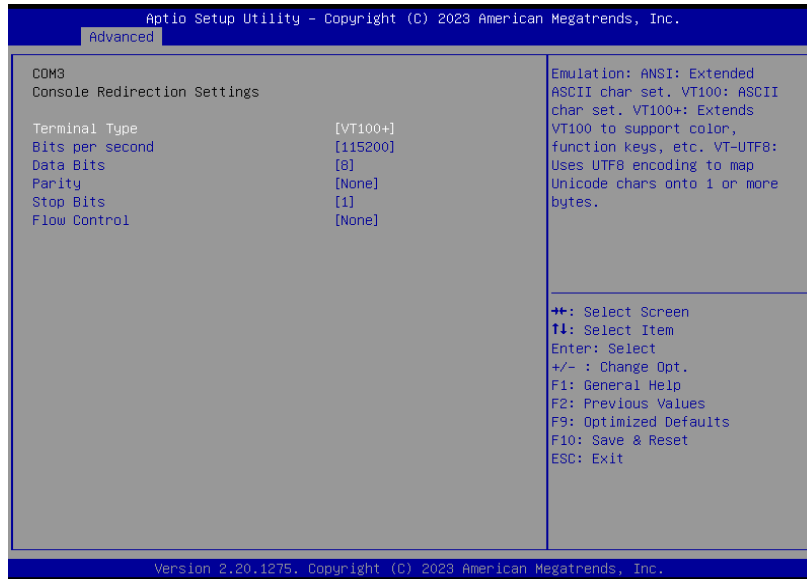

Configure the serial settings of the current COM port.

**Terminal Type**

Select terminal type: VT100, VT100+, VT-UTF8 or ANSI.

**Bits per second**

Select serial port transmission speed: 9600, 19200, 38400, 57600 or 115200.

**Data Bits**

Select data bits: 7 bits or 8 bits.

**Parity**

Select parity bits: None, Even, Odd, Mark or Space.

**Stop Bits**

Select stop bits: 1 bit or 2 bits.

**Flow Control**

Select flow control type: None or Hardware RTS/CTS. Flow Control is for RS485 mode and is only supported by Serial Port 1 (COM1).

► Advanced

## USB Configuration

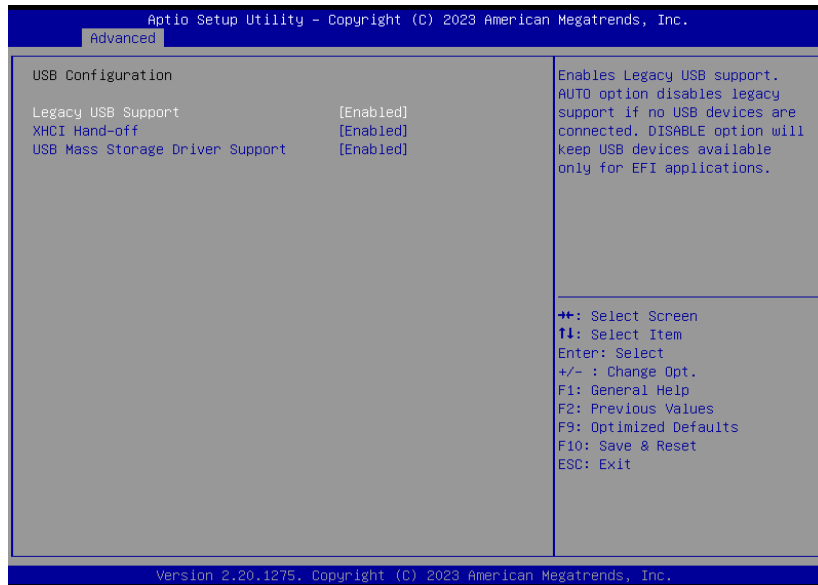

### Legacy USB Support

- **Enabled** Enable Legacy USB support.
- **Disabled** Keep USB devices available only for EFI applications.
- **Auto** Disable Legacy support if no USB devices are connected.

### XHCI Hand-off

Enable or disable XHCI Hand-off.

### USB Mass Storage Driver Support

Enable or disable USB Mass Storage Driver Support.

► Advanced

## CSM Configuration

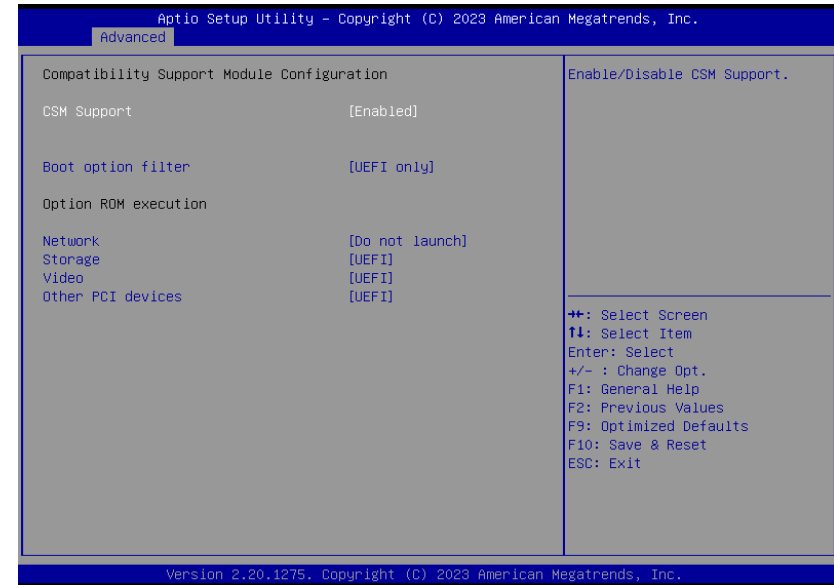

### CSM Support

This section is used to enable or disable CSM Support. The following fields are only available when "CSM Support" is enabled.

### Boot option filter

This field controls Legacy/UEFI ROMs priority. Select among UEFI and Legacy, Legacy only or UEFI only.

### Network

This field controls the execution of UEFI and Legacy Network OpROM.

### Storage

This field controls the execution of UEFI and Legacy Storage OpROM.

### Video

This field controls the execution of UEFI and Legacy Video OpROM.

### Other PCI devices

This field determines OpROM execution policy for devices other than Network, Storage or Video.

▶ Advanced

## USB Power Control

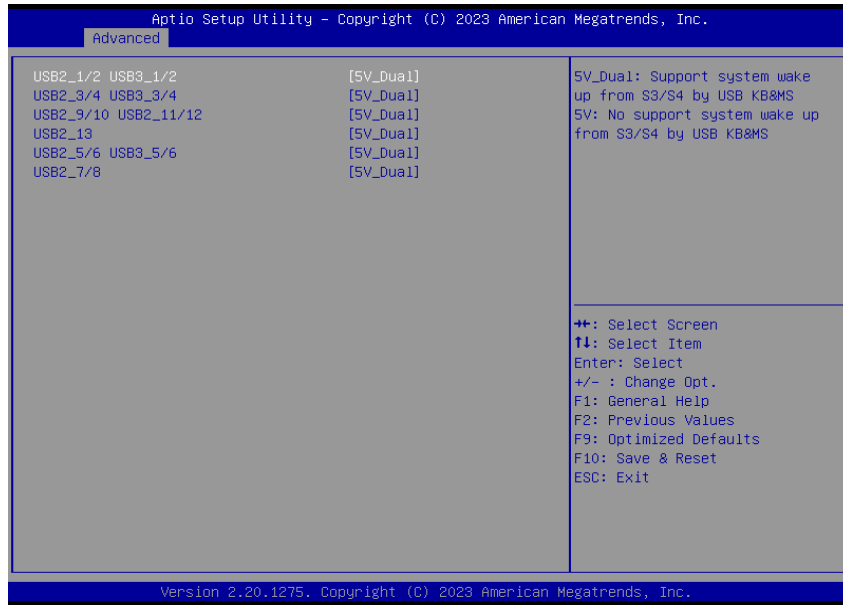

### Server CA Configuration

**5\_Dual:** Support system wake up from S3/S4 by USB KB&MS

**5V:** No support system wake up from S3/S4 by USB KB&MS

▶ Advanced

## Network Stack Configuration

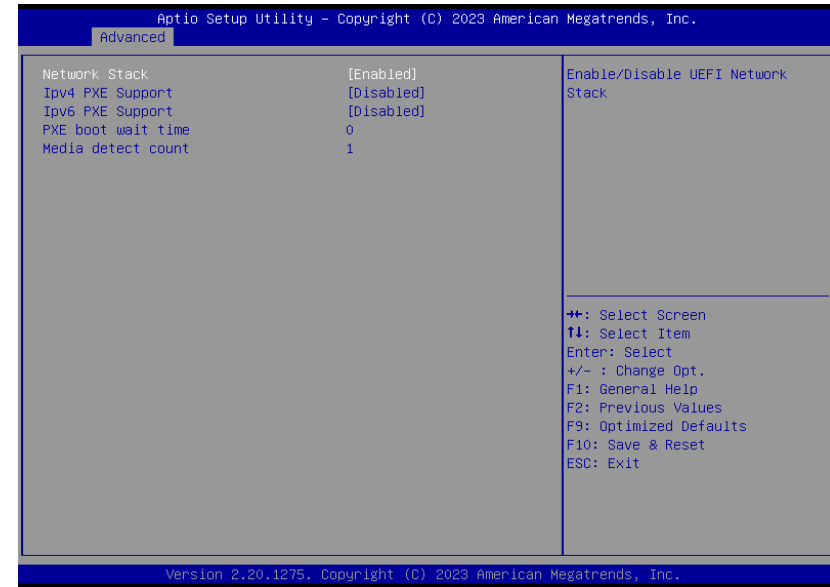

### Network Stack

Enable or disable UEFI network stack. The following fields will appear when this field is enabled.

### Ipv4 PXE Support

Enable or disable IPv4 PXE boot support. If disabled, IPv4 PXE boot support will not be available.

### Ipv6 PXE Support

Enable or disable IPv6 PXE boot support. If disabled, IPv6 PXE boot support will not be available.

### PXE boot wait time

Set the wait time in seconds to press ESC key to abort the PXE boot. Use either +/- or numeric keys to set the value.

### Media detect count

Set the number of times the presence of media will be checked. Use either +/- or numeric keys to set the value.

► Chipset



Please select a submenu and press Enter. The submenus are detailed in the following pages.

► Chipset

Graphics Configuration

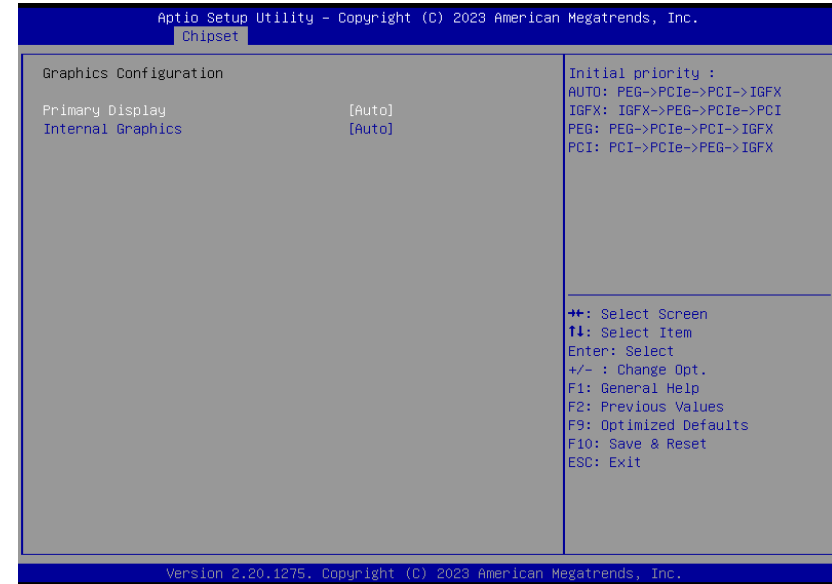

**Primary Display**

Select which of IGFX/PEG/PCI Graphics device to be the primary display.

**Internal Graphics**

Keep IGFX "Enabled" or "Disabled" based on the setup options, or select "Auto" for auto-detection.

► Chipset

PEG Port Configuration

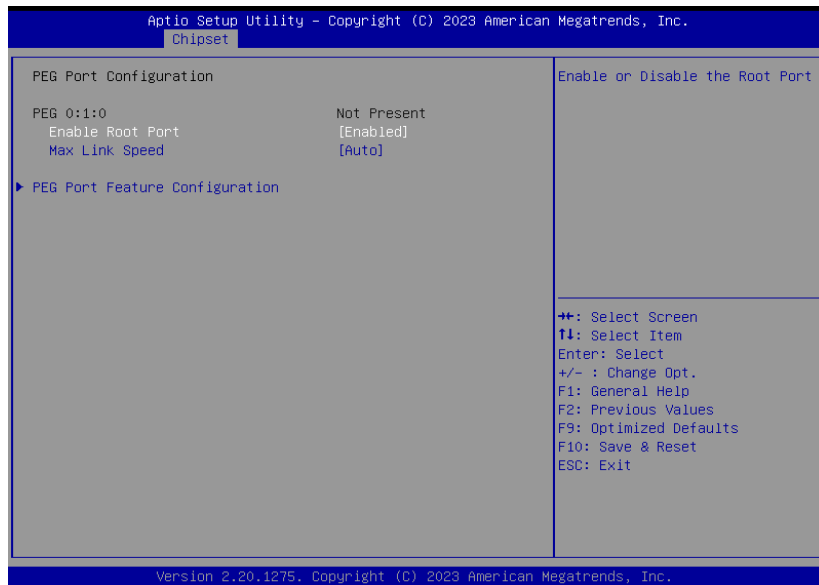

**Enable Root Port**

Enable or disable the root port, or select "Auto" for auto-detection.

**Max Link Speed**

Configure PCIE2/PCIE4 port's Max Speed: Auto, Gen1, Gen2 or Gen3.

► Chipset

PCH-IO Configuration

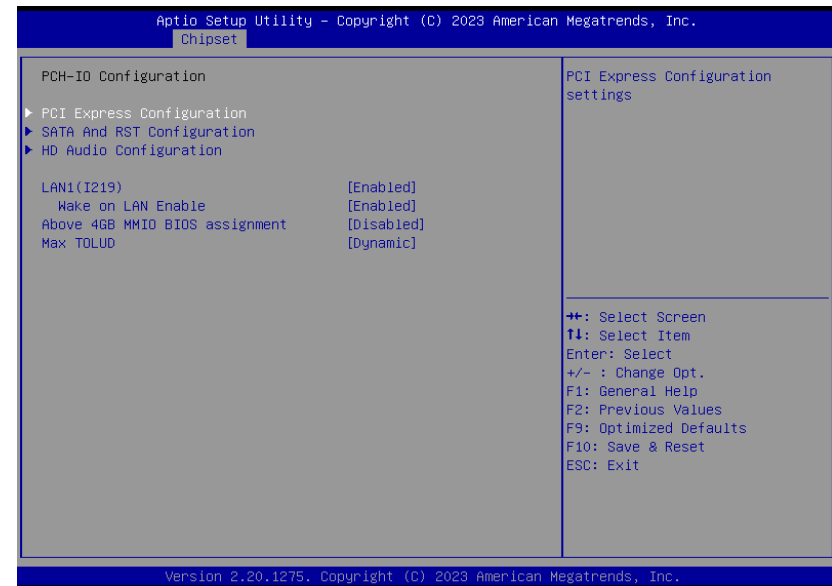

**PCI Express Configuration**

PCI Express Configuration Settings

**SATA Configuration**

SATA Device Options Settings

**HD Audio Configuration**

HD Audio Subsystem Configuration Settings

**LAN1(I219)**

Enable or disable onboard NIC.

**Wake on LAN Enable**

Enable or disable integrated LAN to wake the system.

**Above 4GB MMIO BIOS assignment**

Enable/Disable above 4GB MemoryMappedIO BIOS assignment. This is enabled automatically when Aperture Size is set to 2048MB.

**Max TOLUD**

Assign the maximum value of Top Of Lower Usable DRAM (TOLUD). Select to specify a fixed value, or select "Dynamic" so that the assignment would adjust TOLUD automatically based on largest MMIO length of installed graphic controller.

► Chipset

PCH-IO Configuration ► PCI Express Configuration

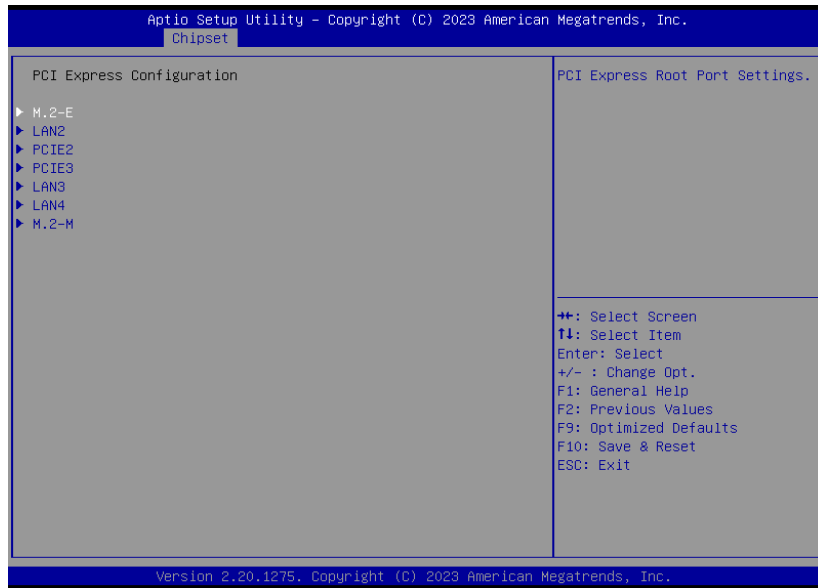

Select one of the PCI Express channels and press enter to configure the following settings.

**LAN2, LAN3, LAN4, M.2-E, M.2-M, PCIE2, PCIE3**

Control the PCI Express Root Port.

► Chipset

PCH-IO Configuration ► SATA Configuration

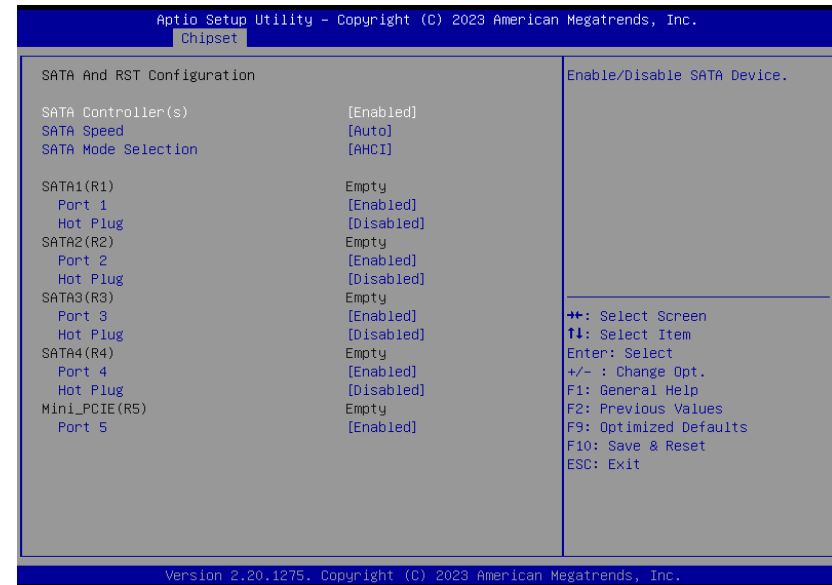

**SATA Controller(s)**

This field is used to enable or disable the Serial ATA controller.

**SATA Speed**

This field is used to select SATA speed generation limit: Auto, Gen1, Gen2 or Gen3.

**SATA Mode Selection**

The mode selection determines how the SATA controller(s) operates.

- **AHCI**

This option allows the Serial ATA controller(s) to use AHCI (Advanced Host Controller Interface).

**Ports and Hot Plug**

Enable or disable the Serial ATA port and its hot plug function.

► Chipset

PCH-IO Configuration ► HD Audio Configuration

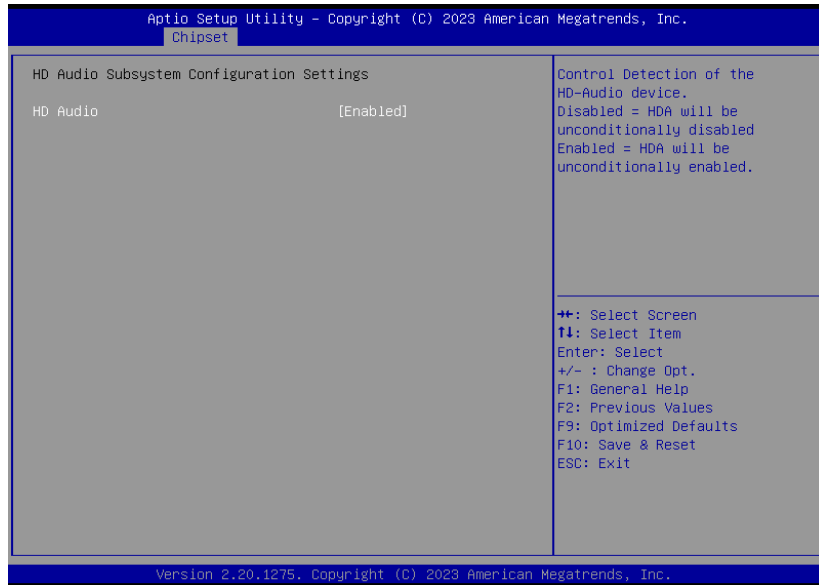

**HD Audio**

Control the detection of the HD Audio device.

- **Disabled** HDA will be unconditionally disabled.
- **Enabled** HDA will be unconditionally enabled.



► Security

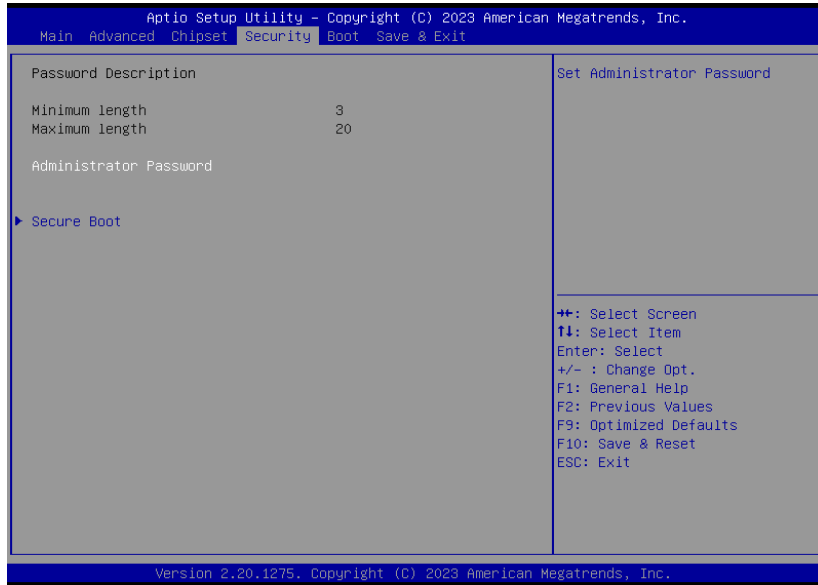

**Administrator Password**

Set the administrator password. To clear the password, input nothing and press enter when a new password is asked. Administrator Password will be required when entering the BIOS.

**User Password**

Set the user password. To clear the password, input nothing and press enter when a new password is asked. User Password will be required when powering up the system.

► Security

Secure Boot

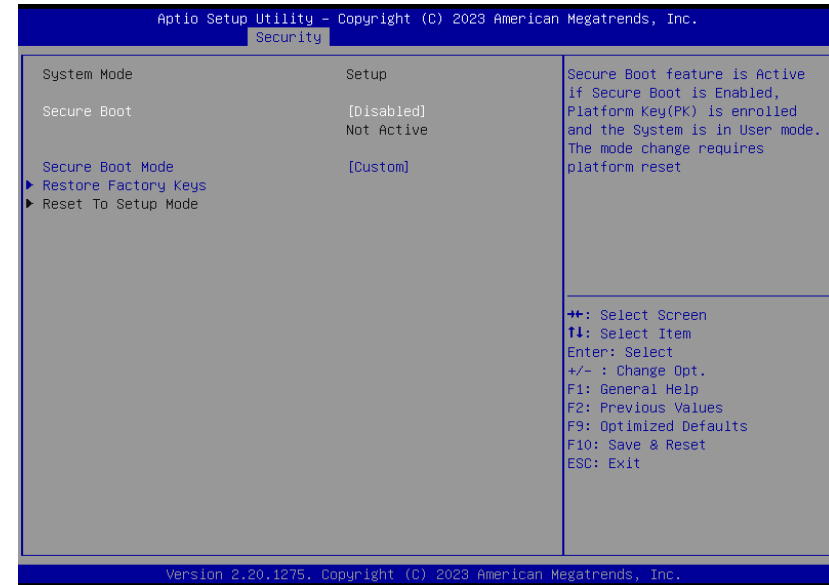

**Secure Boot**

The Secure Boot store a database of certificates in the firmware and only allows the OSEs with authorized signatures to boot on the system. To activate Secure Boot, please make sure that "Secure Boot" is "[Enabled]", Platform Key (PK) is enrolled, "System Mode" is "User", and CSM is disabled. After enabling/disabling Secure Boot, please save the configuration and restart the system. When configured and activated correctly, the Secure Boot status will be "Active".

**Secure Boot Mode**

Select the secure boot mode – Standard or Custom. When set to Custom, the following fields will be configurable for the user to manually modify the key database.

**Restore Factory Keys**

Force system to User Mode. Load OEM-defined factory defaults of keys and databases onto the Secure Boot. Press Enter and a prompt will show up for you to confirm.

**Reset To Setup Mode**

Clear the database from the NVRAM, including all the keys and signatures installed in the Key Management menu. Press Enter and a prompt will show up for you to confirm.

► Boot

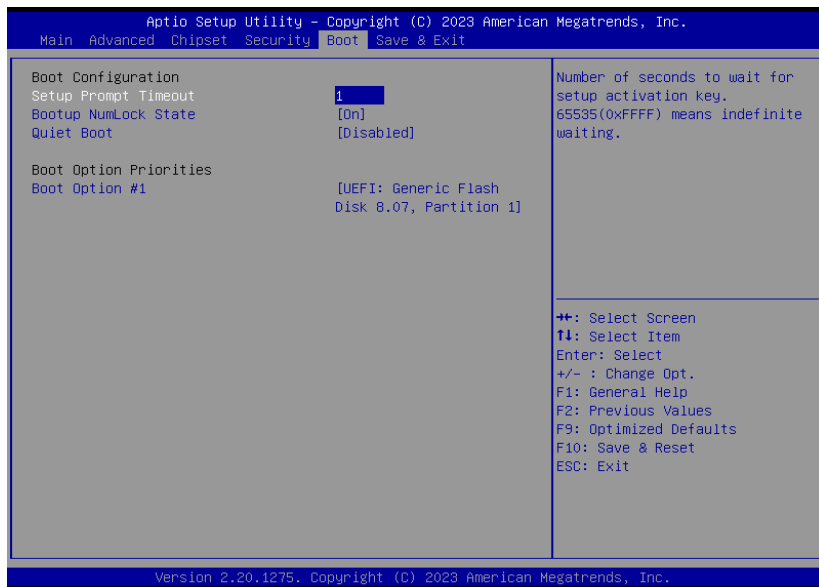

**Setup Prompt Timeout**

Set the number of seconds to wait for the setup activation key. 65535 (0xFFFF) denotes indefinite waiting.

**Bootup NumLock State**

Select the keyboard NumLock state: On or Off.

**Quiet Boot**

This section is used to enable or disable quiet boot option.

**Boot Option Priorities**

Rearrange the system boot order of available boot devices.



**Note:**

If “Boot option filter” of “CSM Configuration” is set to “UEFI and Legacy” or “UEFI only”, and “Quiet Boot” is set to enabled, “BGRT Logo” will show up for configuration. Refer to the Advanced > CSM Configuration submenu for more information.

► Save & Exit

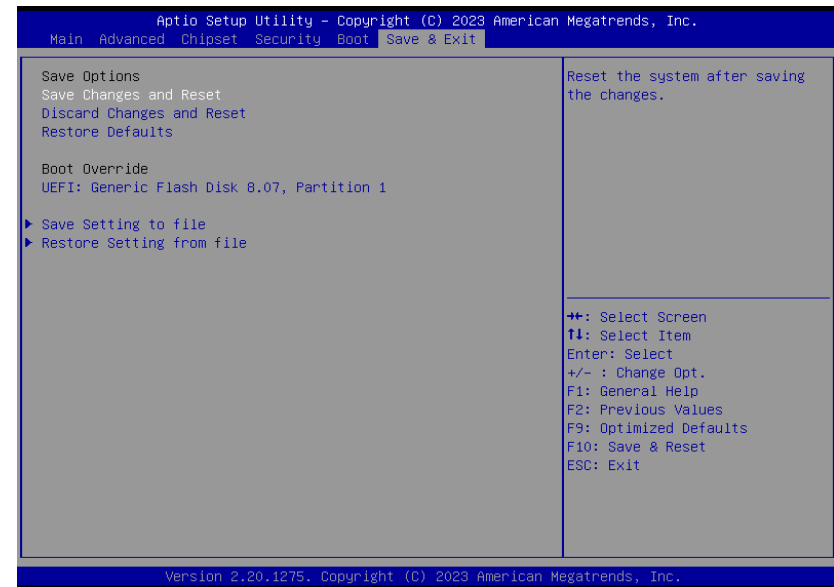

**Save Changes and Reset**

To save the changes, select this field and then press <Enter>. A dialog box will appear. Select Yes to reset the system after saving all changes made.

**Discard Changes and Reset**

To discard the changes, select this field and then press <Enter>. A dialog box will appear. Select Yes to reset the system setup without saving any changes.

**Restore Defaults**

To restore and load the optimized default values, select this field and then press <Enter>. A dialog box will appear. Select Yes to restore the default values of all the setup options.

**Boot Override**

Move the cursor to an available boot device and press Enter, and then the system will immediately boot from the selected boot device. The Boot Override function will only be effective for the current boot. The “Boot Option Priorities” configured in the Boot menu will not be changed.

- **Save Setting to file** Select this option to save BIOS configuration settings to a USB flash device.
- **Restore Setting from file** This field will appear only when a USB flash device is detected. Select this field to restore setting from the USB flash device.

## ► Updating the BIOS

---

To update the BIOS, you will need the new BIOS file and a flash utility. Please contact technical support or your sales representative for the files and specific instructions about how to update BIOS with the flash utility.

## ► Notice: BIOS SPI ROM

---

1. The Intel® Management Engine has already been integrated into this system board. Due to the safety concerns, the BIOS (SPI ROM) chip cannot be removed from this system board and used on another system board of the same model.
2. The BIOS (SPI ROM) on this system board must be the original equipment from the factory and cannot be used to replace one which has been utilized on other system boards.
3. If you do not follow the methods above, the Intel® Management Engine will not be updated and will cease to be effective.



**Note:**

- a. You can take advantage of flash tools to update the default configuration of the BIOS (SPI ROM) to the latest version anytime.
- b. When the BIOS IC needs to be replaced, you have to populate it properly onto the system board after the EEPROM programmer has been burned and follow the technical person's instructions to confirm that the MAC address should be burned or not.
- c. After updating unique MAC Address from manufacturing, NVM will be protected immediately after power cycle. Users cannot update NVM or MAC address.