

RPS310-R680E/Q670E

microATX Industrial Motherboard
User's Manual

Copyright

This publication contains information that is protected by copyright. No part of it may be reproduced in any form or by any means or used to make any transformation/adaptation without the prior written permission from the copyright holders.

This publication is provided for informational purposes only. The manufacturer makes no representations or warranties with respect to the contents or use of this manual and specifically disclaims any express or implied warranties of merchantability or fitness for any particular purpose. The user will assume the entire risk of the use or the results of the use of this document. Further, the manufacturer reserves the right to revise this publication and make changes to its contents at any time, without obligation to notify any person or entity of such revisions or changes.

Changes after the publication's first release will be based on the product's revision. The website will always provide the most updated information.

© 2023. All Rights Reserved.

Trademarks

Product names or trademarks appearing in this manual are for identification purpose only and are the properties of the respective owners.

FCC and DOC Statement on Class B

This equipment has been tested and found to comply with the limits for a Class B digital device, pursuant to Part 15 of the FCC rules. These limits are designed to provide reasonable protection against harmful interference when the equipment is operated in a residential installation. This equipment generates, uses and can radiate radio frequency energy and, if not installed and used in accordance with the instruction manual, may cause harmful interference to radio communications. However, there is no guarantee that interference will not occur in a particular installation. If this equipment does cause harmful interference to radio or television reception, which can be determined by turning the equipment off and on, the user is encouraged to try to correct the interference by one or more of the following measures:

- Reorient or relocate the receiving antenna.
- Increase the separation between the equipment and the receiver.
- Connect the equipment into an outlet on a circuit different from that to which the receiver is connected.
- Consult the dealer or an experienced radio TV technician for help.

Notice:

1. The changes or modifications not expressly approved by the party responsible for compliance could void the user's authority to operate the equipment.
2. Shielded interface cables must be used in order to comply with the emission limits.

Table of Contents

- Chapter 1 - Introduction..... 6
 - Specifications 6
 - Speed Support List..... 8
 - Block Diagram 9
 - Dimension 9
- Chapter 2 - Hardware Installation..... 10
 - Board Layout..... 10
 - Installing the heat sink..... 12
 - Installing the Heat Sink 12
 - Jumper Settings 13
 - DIO Power Select (JP28) 13
 - AT/ATX Mode Select (JP26)..... 13
 - PS/2 and USB Wake up Select (JP25)..... 14
 - DIO0~3 Power Select (JP29) 14
 - DIO4~7 Power Select (JP30) 15
 - M2CN4 Power Select (JP31)..... 15
 - M2CN3 Power Select (JP32)..... 16
 - Pin Assignment 17
 - SYSTEM FAN1 (J7)..... 17
 - SYSTEM FAN2 (J22)..... 17
 - SYSTEM FAN3 (J30)..... 18
 - CPU FAN (J8)..... 18
 - SMBus (J12) 19
 - SATA0 (J31) 19
 - SATA1 (J17) 20
 - SATA2 (J32) 20
 - SATA3 (J31) 21
 - Front Panel (J18)..... 21
 - ESPI Header (J35)..... 22
 - COM1 (TSJ1) 22
 - COM2 (TSJ2) 23
 - COM3 (TSJ3) 23
 - COM4 (TSJ4) 24
 - DIO Power (J33) 24
 - DIO (J34) 25
 - System Memory 26
 - Installing the DIMM Module 26
 - Expansion Slots..... 27
 - Installing the M.2 Module 27
- Chapter 3 - BIOS Settings..... 29
 - Overview 29
 - Main..... 30
 - Advanced 30
 - CPU Configuration 31
 - Power & Performance 31
 - Power & Performance ▶ CPU- Power Management Control 32
 - Power & Performance ▶ GT- Power Management Control 32
 - PCH-FW Configuration 33
 - Trusted Computing 34
 - NCT6126D Super IO Configuration 34
 - NCT6126D Super IO Configuration ▶ Serial Port 1, 2 Configuration 35
 - NCT6126D Super IO Configuration ▶ Serial Port 3, 4 Configuration 35
 - NCT6126D HW Monitor 36

- NCT6126D HW Monitor ▶ Smart FAN Function 36
- Serial Port Console Redirection 37
- Serial Port Console Redirection ▶ Console Redirection Settings..... 37
- ACPI Settings 38
- USB Configuration 39
- Network Stack Configuration..... 40
- DFI WDT Configuration..... 41
- USB Power Control 41
- Tls Auth Configuration 42
- Chipset 43
 - System Agent (SA) Configuration 43
 - PCH-IO Configuration 44
 - PCH-IO Configuration ▶ PCI Express Configuration 44
 - PCH-IO Configuration ▶ SATA Configuration 45
 - PCH-IO Configuration ▶ HD Audio Configuration 45
- Security 46
 - Secure Boot..... 46
- Boot 47
- Save & Exit 47
- MEBx 48
- Updating the BIOS 49
- Notice: BIOS SPI ROM..... 49
- Chapter 4 - RAID Settings..... 50
 - RAID Levels 50
 - Setup Procedure 50
 - How to enable Intel(R) Rapid Storage Technology in BIOS 51

About this Manual

This manual can be downloaded from the website.

The manual is subject to change and update without notice, and may be based on editions that do not resemble your actual products. Please visit our website or contact our sales representatives for the latest editions.

Warranty

1. Warranty does not cover damages or failures that occur from misuse of the product, inability to use the product, unauthorized replacement or alteration of components and product specifications.
2. The warranty is void if the product has been subjected to physical abuse, improper installation, modification, accidents or unauthorized repair of the product.
3. Unless otherwise instructed in this user's manual, the user may not, under any circumstances, attempt to perform service, adjustments or repairs on the product, whether in or out of warranty. It must be returned to the purchase point, factory or authorized service agency for all such work.
4. We will not be liable for any indirect, special, incidental or consequential damages to the product that has been modified or altered.

Static Electricity Precautions

It is quite easy to inadvertently damage your PC, system board, components or devices even before installing them in your system unit. Static electrical discharge can damage computer components without causing any signs of physical damage. You must take extra care in handling them to ensure against electrostatic build-up.

1. To prevent electrostatic build-up, leave the system board in its anti-static bag until you are ready to install it.
2. Wear an antistatic wrist strap.
3. Do all preparation work on a static-free surface.
4. Hold the device only by its edges. Be careful not to touch any of the components, contacts or connections.
5. Avoid touching the pins or contacts on all modules and connectors. Hold modules or connectors by their ends.



Important:

Electrostatic discharge (ESD) can damage your processor, disk drive and other components. Perform the upgrade instruction procedures described at an ESD workstation only. If such a station is not available, you can provide some ESD protection by wearing an antistatic wrist strap and attaching it to a metal part of the system chassis. If a wrist strap is unavailable, establish and maintain contact with the system chassis throughout any procedures requiring ESD protection.

Safety Measures

- To avoid damage to the system, use the correct AC input voltage range.
- To reduce the risk of electric shock, unplug the power cord before removing the system chassis cover for installation or servicing. After installation or servicing, cover the system chassis before plugging the power cord.

About the Package

The package contains the following items. If any of these items are missing or damaged, please contact your dealer or sales representative for assistance.

- 1 RPS310-R680E/Q670E motherboard
- 1 COM port cable (Length: 300mm, 2 x COM ports)
- 1 Serial ATA data cable (Length: 500mm)
- 1 I/O shield

The board and accessories in the package may not come similar to the information listed above. This may differ in accordance with the sales region or models in which it was sold. For more information about the standard package in your region, please contact your dealer or sales representative.

Before Using the System Board

When installing the system board in a new system, you will need at least the following internal components.

- Memory module
- Storage device such as a hard disk drive.
- Power supply

External system peripherals may also be required for navigation and display, including at least a keyboard, a mouse and a video display monitor.

Chapter 1 - Introduction

► Specifications

SYSTEM	Processor	<p>14th Generation Intel® LGA 1700 Socket Processors, TDP support up to 125W Intel® Core™ i9-14900 (24 Cores, 36M Cache, up to 2.0 GHz); 65W Intel® Core™ i9-14900T (24 Cores, 36M Cache, up to 1.1 GHz); 35W Intel® Core™ i7-14700 (20 Cores, 33M Cache, up to 2.1 GHz); 65W Intel® Core™ i7-14700T (20 Cores, 33M Cache, up to 1.3 GHz); 35W Intel® Core™ i5-14500 (14 Cores, 24M Cache, up to 2.6 GHz); 65W Intel® Core™ i5-14500T (14 Cores, 24M Cache, up to 1.7 GHz); 35W Intel® Core™ i3-14100 (4 Cores, 12M Cache, up to 3.5 GHz); 60W Intel® Core™ i3-14100T (4 Cores, 12M Cache, up to 2.7 GHz); 35W Intel® Core™ i300T (2 Cores, 6M Cache, up to 3.4 GHz); 35W</p> <p>13th Generation Intel® LGA 1700 Socket Processors, TDP support up to 125W Intel® Core™ i9-13900E (24 Cores, 36M Cache, up to 5.2 GHz); 65W Intel® Core™ i9-13900TE (24 Cores, 36M Cache, up to 5.0 GHz); 35W Intel® Core™ i7-13700E (16 Cores, 30M Cache, up to 5.1 GHz); 65W Intel® Core™ i7-13700TE (16 Cores, 30M Cache, up to 4.8 GHz); 35W Intel® Core™ i7-13700T (16 Cores, 30M Cache, up to 4.9 GHz); 35W Intel® Core™ i5-13500E (14 Cores, 24M Cache, up to 4.6 GHz); 65W Intel® Core™ i5-13500TE (14 Cores, 24M Cache, up to 4.5 GHz); 35W Intel® Core™ i5-13500T (14 Cores, 24M Cache, up to 4.6 GHz); 35W Intel® Core™ i5-13400E (10 Cores, 20M Cache, up to 4.6 GHz); 65W Intel® Core™ i3-13100E (4 Cores, 12M Cache, up to 4.4 GHz); 65W Intel® Core™ i3-13100TE (4 Cores, 12M Cache, up to 4.1 GHz); 35W Intel® Core™ i3-13100T (4 Cores, 12M Cache, up to 4.2 GHz); 35W</p> <p>12th Generation Intel® LGA 1700 Socket Processors, TDP support up to 125W Intel® Core™ i9-12900E (16 Cores, 30M Cache, up to 5.0 GHz); 65W Intel® Core™ i9-12900TE (16 Cores, 30M Cache, up to 4.8 GHz); 35W Intel® Core™ i7-12700E (12 Cores, 25M Cache, up to 4.8 GHz); 65W Intel® Core™ i7-12700TE (12 Cores, 25M Cache, up to 4.6 GHz); 35W Intel® Core™ i5-12500E (6 Cores, 18M Cache, up to 4.5 GHz); 65W Intel® Core™ i5-12500TE (6 Cores, 18M Cache, up to 4.3 GHz); 35W Intel® Core™ i3-12100E (4 Cores, 12M Cache, up to 4.2 GHz); 60W Intel® Core™ i3-12100TE (4 Cores, 12M Cache, up to 4.0 GHz); 35W Intel® Pentium® G7400E (2 Cores, 6M Cache, 3.6 GHz); 46W Intel® Pentium® G7400TE (2 Cores, 6M Cache, 3.0 GHz); 35W Intel® Celeron® G6900E (2 Cores, 4M Cache, 3.0 GHz); 46W Intel® Celeron® G6900TE (2 Cores, 4M Cache, 2.4 GHz); 35W</p>
	Chipset	Intel® R680E/Q670E Chipset
	Memory	Four 288-pin UDIMM up to 128GB (ECC/Non-ECC) Dual Channel DDR5 up to 4400 MHz *only R680E support ECC memory *Speed Support List: Please refer to page.8
	BIOS	AMI SPI 256Mbit

GRAPHICS	Controller	Intel® HD Gen 9 Graphics
	Feature	OpenGL 4.5, DirectX 12, OpenCL 2.1 HW Decode: AVC/H.264, MPEG2, VC1/WMV9, JPEG/MJPEG, HEVC/H265, VP8, VP9 HW Encode: MPEG2, AVC/H264, JPEG, HEVC/H265, VP8, VP9
	Display	1 x VGA, resolution up to 1920x1200 @ 60Hz 2 x DP++, resolution up to 4096x2304 @ 60Hz 1 x HDMI 2.0a, resolution up to 4096x2160 @ 24Hz
	Quad Displays	VGA + 2 DP++ + HDMI
EXPANSION	Interface	2 x PCIe x16 (Gen 4) (1 x16 signals or 2 x8 signals) 2 x PCIe x4 (Gen 4) 1 x M.2 2230 E key (opt. PCIe/USB 2.0/Intel CNVi support) (Discrete Wifi 6E support) 1 x M.2 2242/2260/2280 M key (PCIe x4 Gen4 NVMe/SATA support) 1 x M.2 2242/2260/2280 M key (PCIe x4 Gen4 NVMe support)
AUDIO	Audio Codec	Realtek ALC888
ETHERNET	Controller	1 Intel® I226-LM (Core i9/i7/i5 support iAMT) 1 Intel® I226-V 2 Intel® I226-V (only R680E support)
REAR I/O	Ethernet	2 x 2.5GbE (RJ-45) or 4 x 2.5GbE (RJ-45) (only R680E support)
	USB	4 x USB 3.2 Gen 2 4 x USB 3.2 Gen 1
	Display	2 x DP++ 1 x HDMI 2.0a 1 x VGA
	Audio	1 x Line-out, 1 x Mic-in, 1 x Line-in (optional by request, MOQ required)
INTERNAL I/O	Serial	2 x RS-232/422/485 (RS-232 w/ power) (2.54mm pitch) 2 x RS-232 (2.54mm pitch)
	USB	2 x USB 3.2 Gen1 4 x USB 2.0 (2.54mm pitch) (1 x USB 2.0 colay vertical Type A)
	Audio	1 x Front Audio Header 1 x S/PDIF
	SATA	4 x SATA 3.0 (up to 6Gb/s) RAID 0/1/5/10
	PS/2	1 x PS/2 (2.54mm pitch)
	DIO	1 x 4-IN / 8-OUT DIO
	SMBus	1 x SMBus

WATCHDOG TIMER	Output & Interval	System Reset, Programmable via Software from 1 to 255 Seconds
SECURITY	TPM	Nuvoton TPM 2.0
POWER	Type	ATX
	Connector	8-pin ATX 12V power 24-pin ATX power
	Consumption	TBD
	RTC Battery	CR2032 Coin Cell
OS SUPPORT	Microsoft	Windows 10 IoT Enterprise 64-bit
	Linux	Linux
ENVIRONMENT	Temperature	Operating: -5 to 65°C Storage: -30 to 60°C with RTC Battery; -40 to 85°C without RTC Battery
	Humidity	Operating: 5 to 95% RH Storage: 5 to 95% RH
	MTBF	TBD
MECHANISM	Dimensions	microATX Form Factor: 244mm (9.6") x 244mm (9.6")
	Height	PCB: 1.6mm Top Side: TBD Bottom Side: TBD
STANDARDS AND CERTIFICATIONS	Certifications	CE, FCC Class B, RoHS

► Speed Support List

DIMMs	RANK	POR	CHA		CHB	
			DIMM1	DIMM2	DIMM3	DIMM4
1DIMM	1R/2R	No support	V			
1DIMM	1R/2R	4400MHz		V		
1DIMM	1R/2R	No support			V	
1DIMM	1R/2R	4400MHz				V
2DIMM	1R/2R	No support	V		V	
2DIMM	1R/2R	4400MHz		V		V
2DIMM	1R	4000MHz	V	V		
2DIMM	1R	4000MHz			V	V
2DIMM	2R	3600MHz	V	V		
2DIMM	2R	3600MHz			V	V
4DIMM	1R	4000MHz	V	V	V	V
4DIMM	2R	3600MHz	V	V	V	V



Important:

Electrostatic discharge (ESD) can damage your board, processor, disk drives, add-in boards, and other components. Perform installation procedures at an ESD workstation only. If such a station is not available, you can provide some ESD protection by wearing an antistatic wrist strap and attaching it to a metal part of the system chassis. If a wrist strap is unavailable, establish and maintain contact with the system chassis throughout any procedures requiring ESD protection.

► Block Diagram

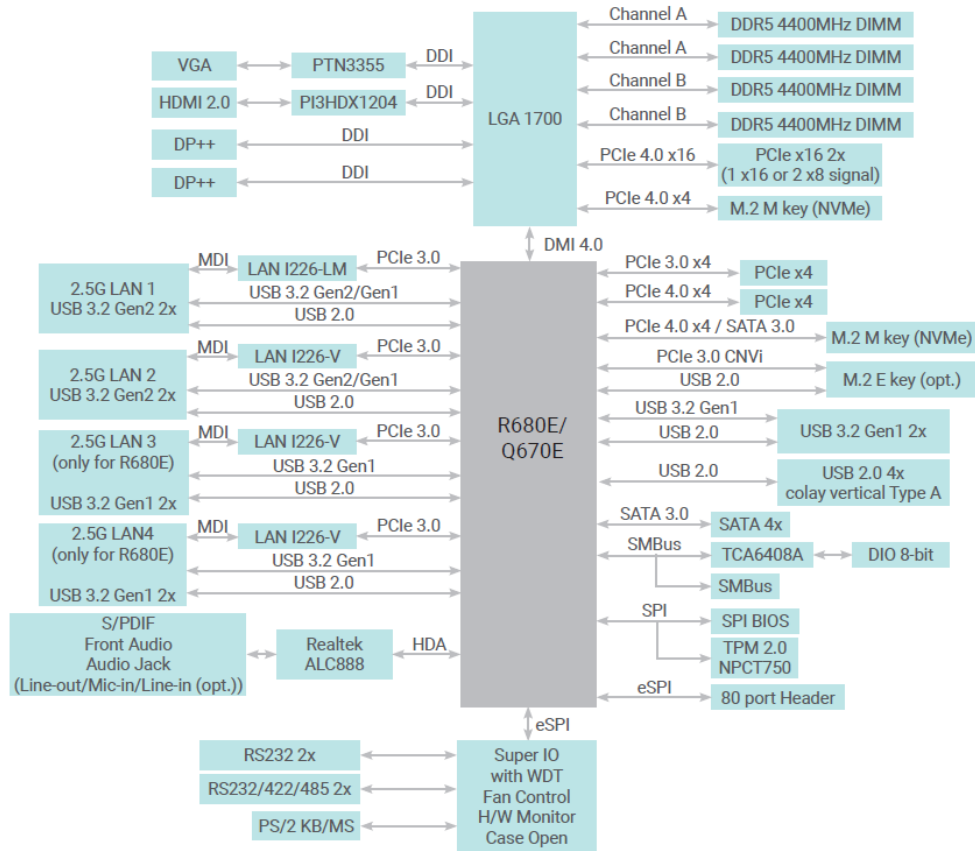

► Dimension

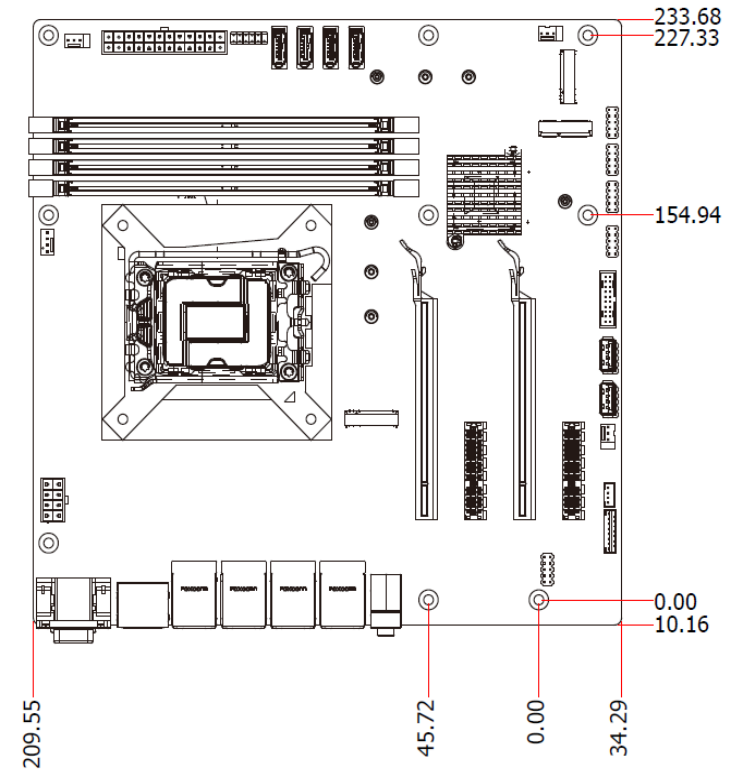

Chapter 2 - Hardware Installation

► Board Layout

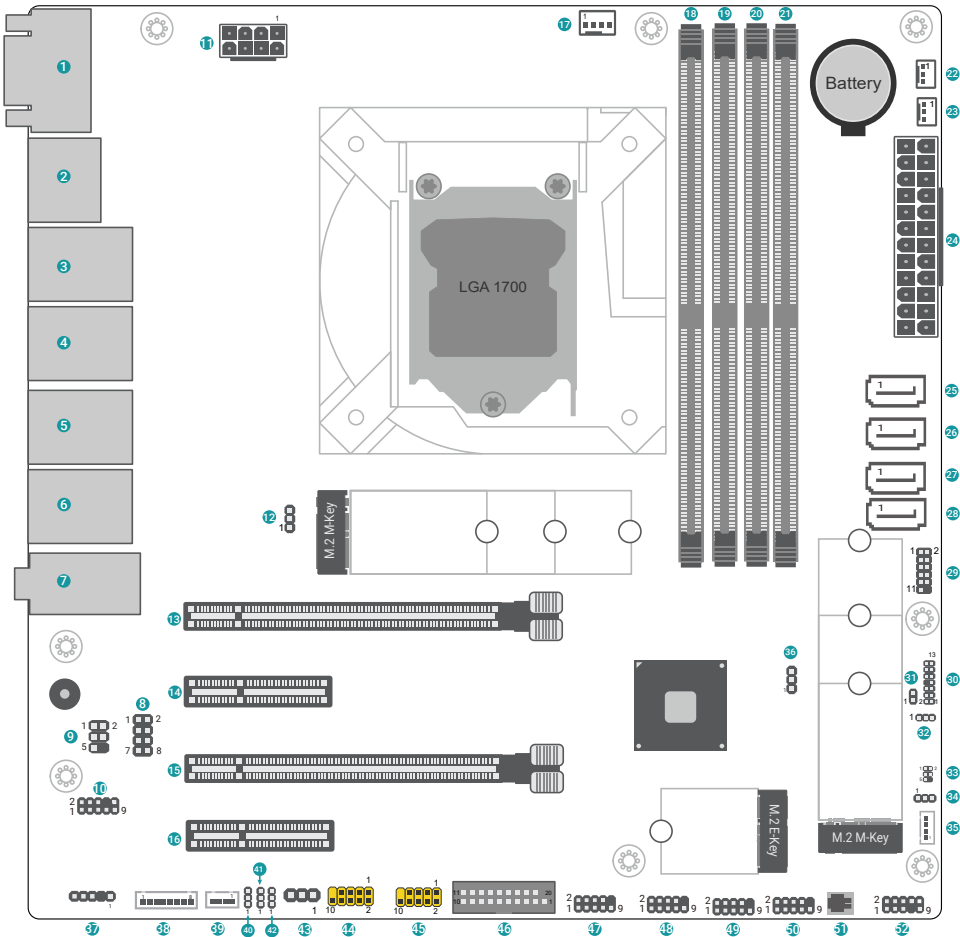

- 1 ▲VGA
▼HDMI
- 2 DP1,DP2
- 3 ▲LAN1
▼USB2_1/2
USB3_1/2
- 4 ▲LAN2
▼USB2_3/4
USB3_3/4
- 5 ▲LAN3
▼USB2_5/6
USB3_5/6
- 6 ▲LAN4
▼USB2_7/8
USB3_7/8
- 7 ▲Line-Out / Line-In (optional)
▼MIC-In
- 8 Front LAN LED
- 9 SMBus
- 10 Front Audio
- 11 +12v Power
- 12 M2CN4 power select
- 13 PCIE1
- 14 PCIE2
- 15 PCIE3
- 16 PCIE4
- 17 CPU FAN
- 18 DIMM1
- 19 DIMM2
- 20 DIMM3
- 21 DIMM4
- 22 System FAN3
- 23 System FAN2
- 24 ATX Power
- 25 SATA0
- 26 SATA1
- 27 SATA2
- 28 SATA3
- 29 Front Panel
- 30 ESPI Header
- 31 Case Open
- 32 AT/ATX mode select
- 33 InnoAGE Header
- 34 M2CN3 power select
- 35 InnoAGE Power
- 36 PS/2 and USB Wake up select
- 37 S/PDIF
- 38 DIO
- 39 DIO Power

40	DIO0~3 power select
41	DIO4~7 power select
42	DIO power select (5V_DIO)
43	SYSTEM FAN1
44	USB2_11/12
45	USB2_13
46	USB3.1 Gen1
47	COM1
48	COM2
49	COM3
50	COM4
51	BIOS
52	PS/2

► Installing the heat sink

Installing the Heat Sink

The CPU must be kept cool by using a heat sink, otherwise the CPU will overheat damaging both the CPU and system board.

- 1. Before you install the fan / heat sink, you must apply a thermal paste onto the top of the CPU. The thermal paste is usually supplied when you purchase the fan / heat sink assembly. Do not spread the paste all over the surface. When you later place the heat sink on top of the CPU, the compound will disperse evenly.

Some heat sinks come with a patch of preapplied thermal paste. Do not apply thermal paste if the fan / heat sink already has a patch of thermal paste on its underside. Peel the strip that covers the paste before you place the fan / heat sink on top of the CPU.

- 2. Place the heat sink on top of the CPU. The 4 spring screws around the heat sink, which are used to secure the heat sink onto the system board, must match the 4 mounting holes around the board.
- 3. Screw tight two of the spring screws at opposite corners into the mounting holes. And then proceed with the other two spring screws.

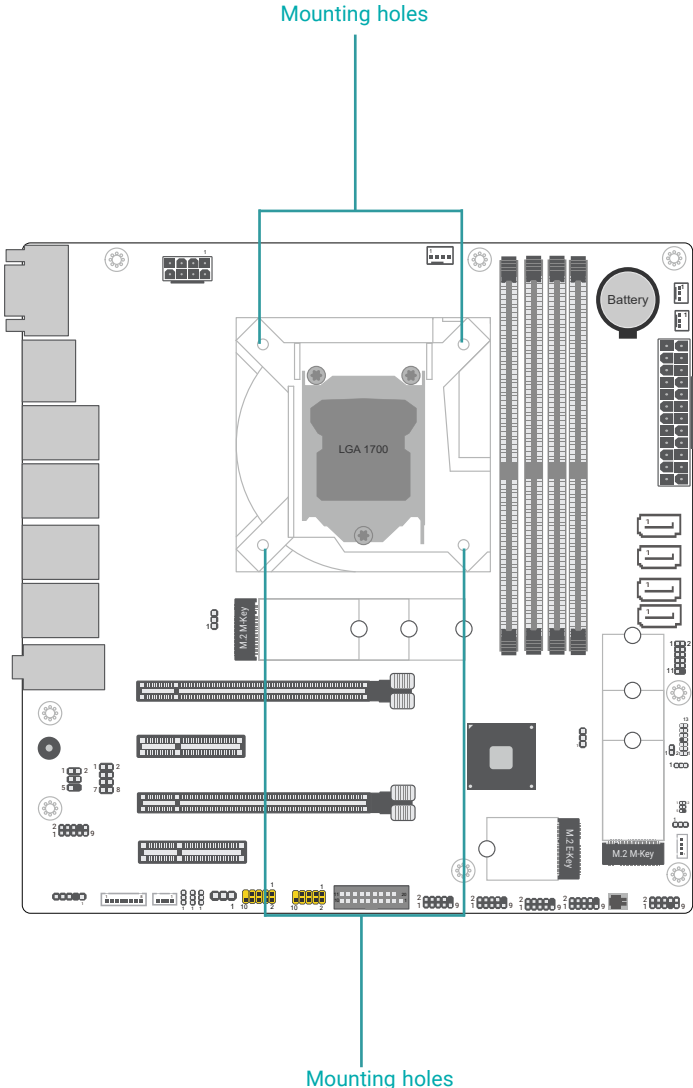

► **Jumper Settings**

DIO Power Select (JP28)

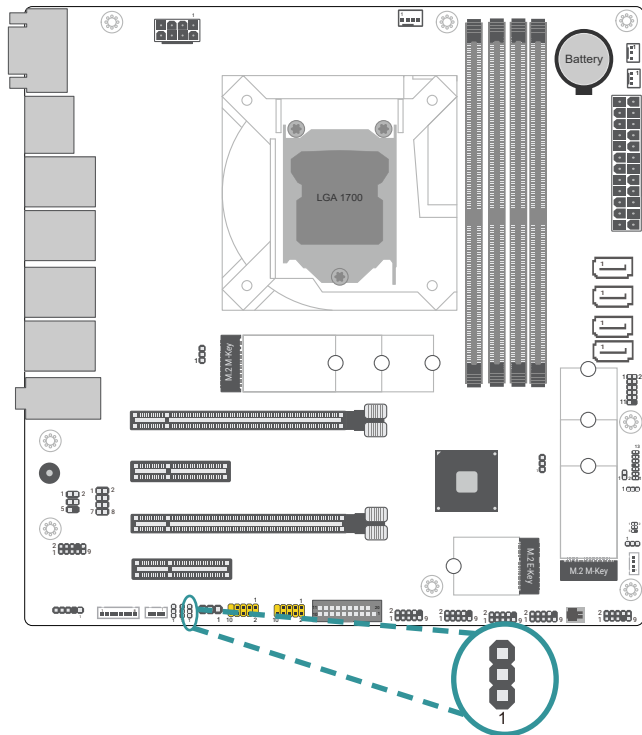

- 1-2 On: 5VDU (Default)
- 2-3 On: 5V

AT/ATX Mode Select (JP26)

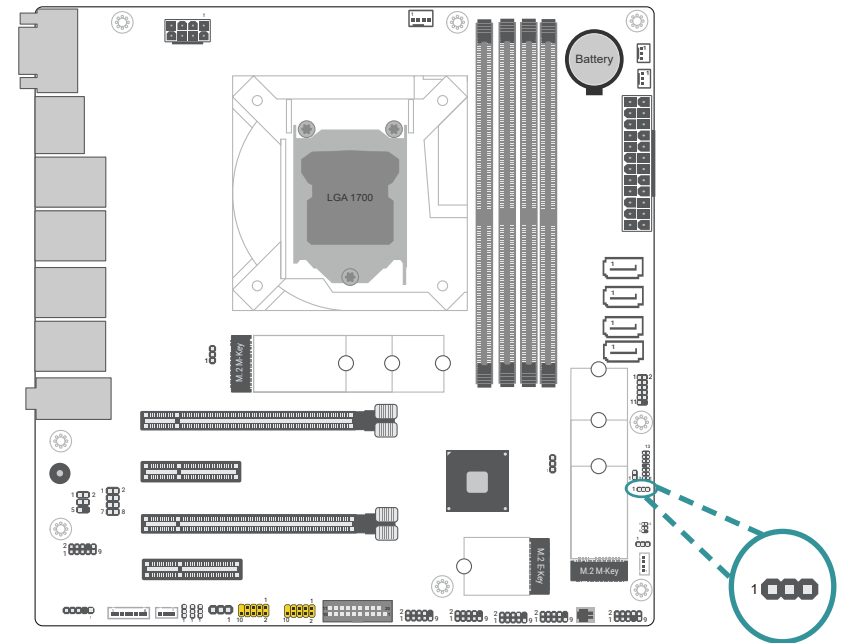

- 1-2 On: AT mode
- 2-3 On: ATX mode (default)

PS/2 and USB Wake up Select (JP25)

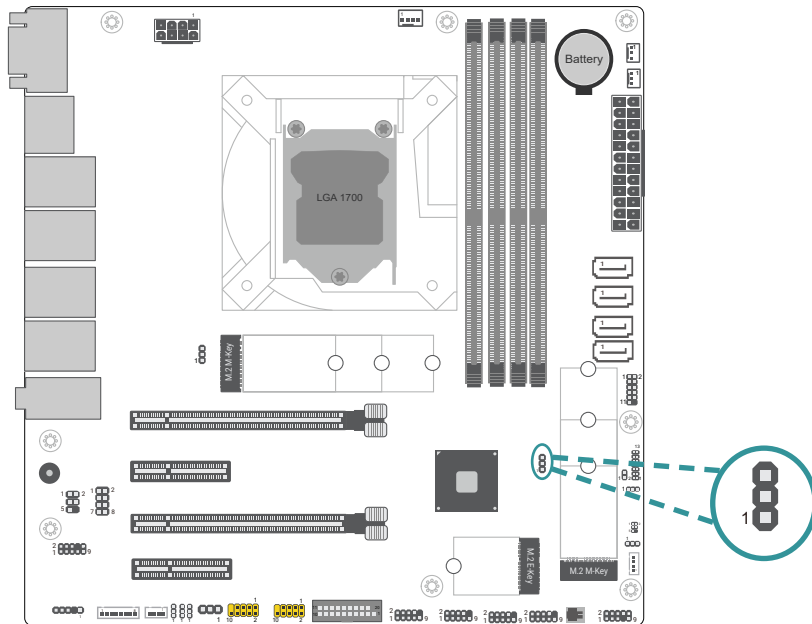

■ 1-2 On: Control by BIOS (default)



■ 2-3 On: Wake up disable

DI00~3 Power Select (JP29)

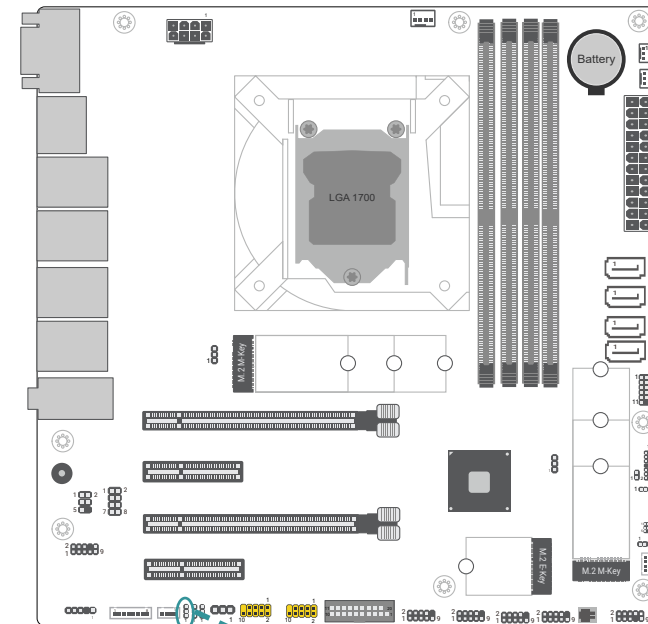

■ 1-2 On: 5V_DIO(default)



■ 2-3 On: GND

DIO4~7 Power Select (JP30)

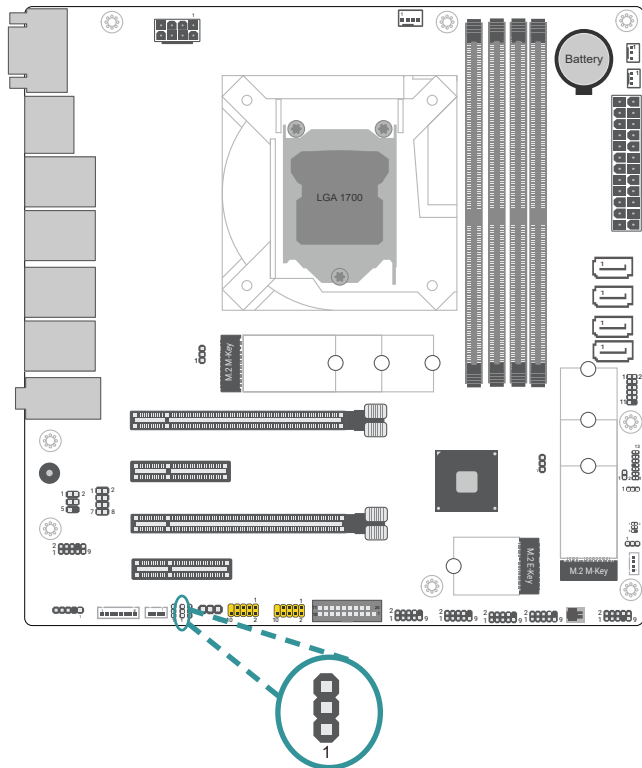

- 1-2 On: 5V_DIO (Default)
- 2-3 On: GND

M2CN4 Power Select (JP31)

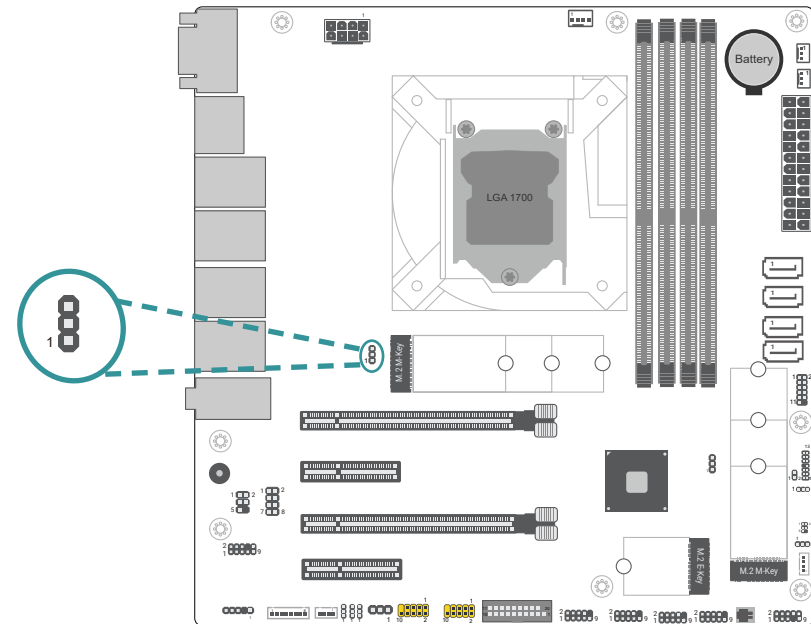

- 1-2 On: 3V3 (default)
- 2-3 On: 3V3DU

M2CN3 Power Select (JP32)

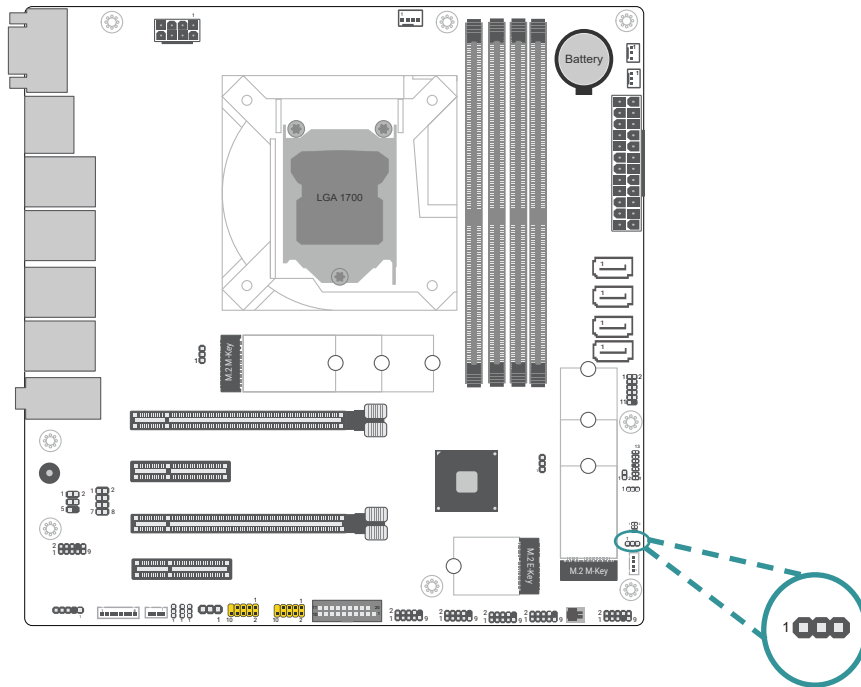

■ 1-2 On: 3V3 (default)



■ 2-3 On: 3V3DU

► **Pin Assignment**

SYSTEM FAN1 (J7)

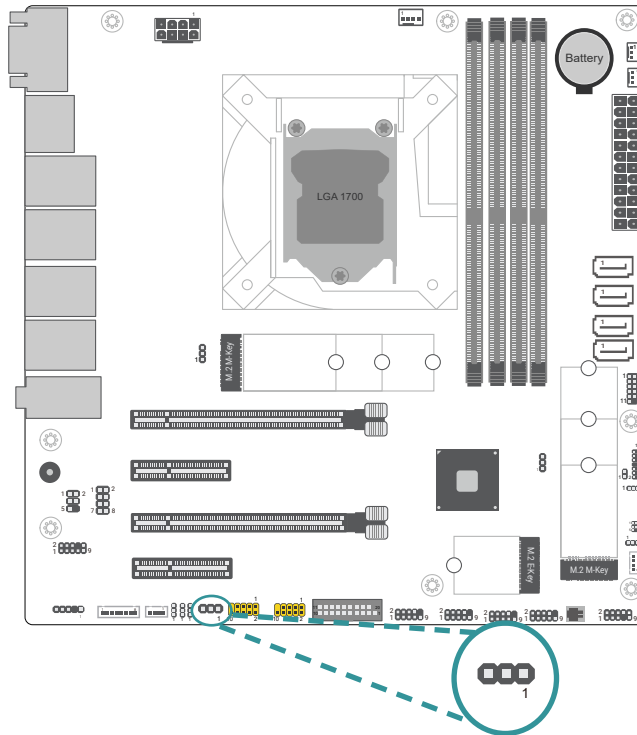

Pin	Assignment
1	GND
2	PWM
3	TACH

SYSTEM FAN2 (J22)

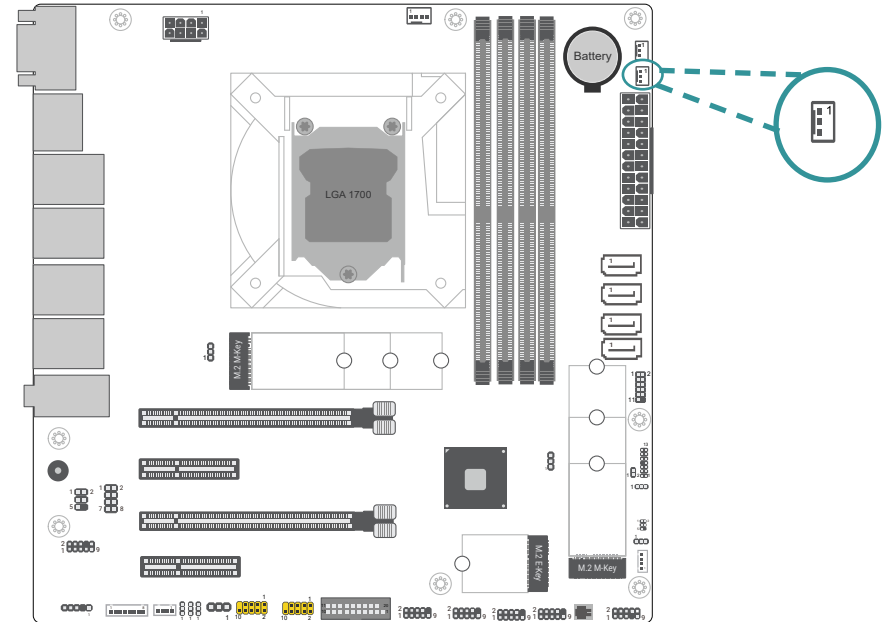

Pin	Assignment
1	GND
2	PWM
3	TACH

SYSTEM FAN3 (J30)

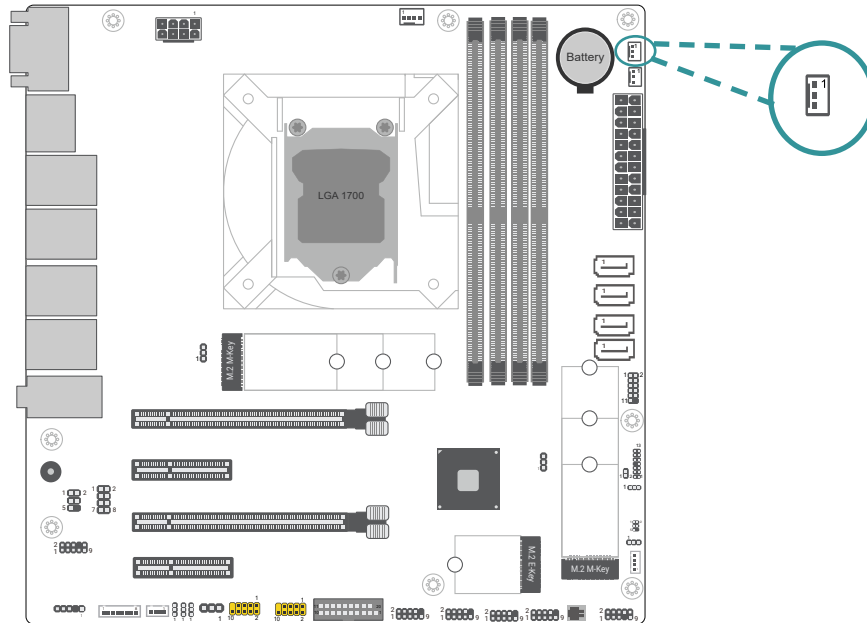

Pin	Assignment
1	GND
2	PWM
3	TACH

CPU FAN (J8)

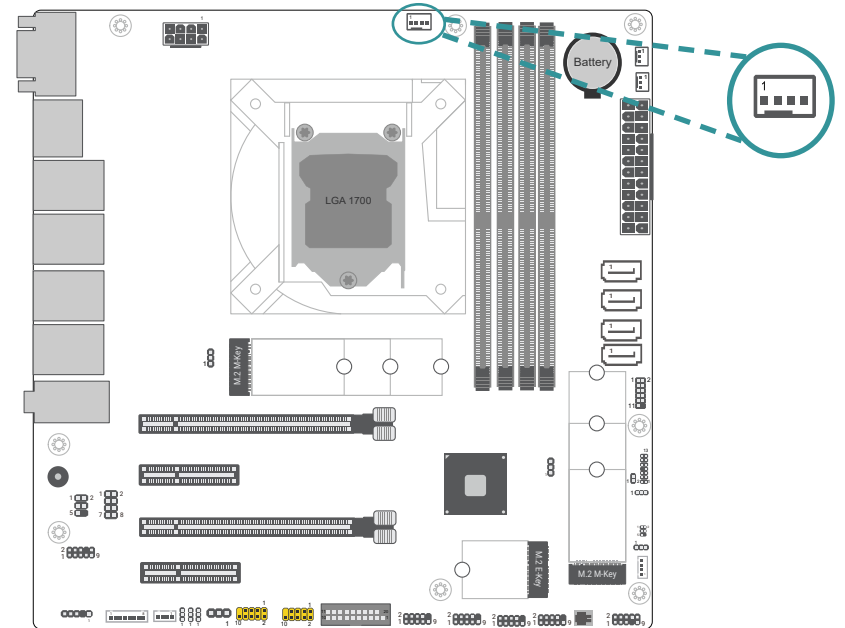

Pin	Assignment
1	GND
2	12V
3	RPM
4	CTRL

SMBus (J12)

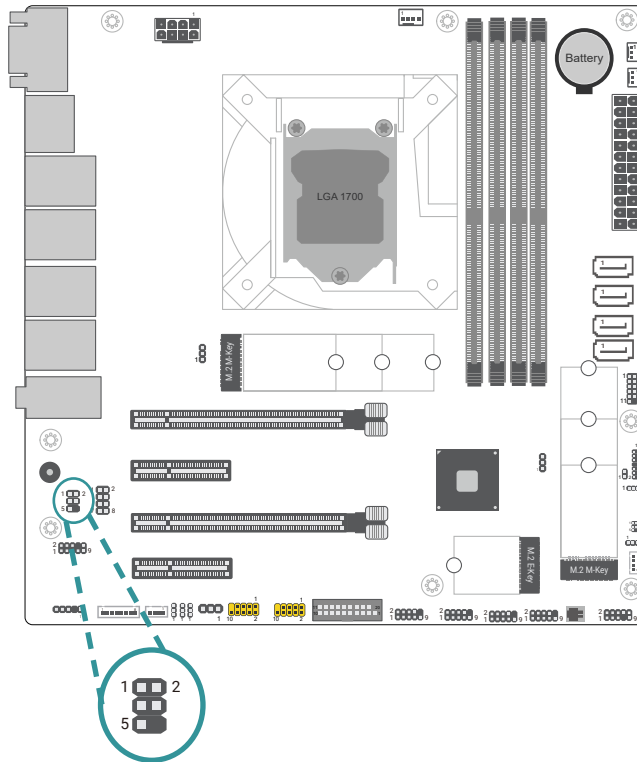

Pin	Assignment	Pin	Assignment
1	3V3DU	2	GND
3	SMB_CLK_RESUME	4	SMB_DATA_RESUME
5	SMBALERT_PCH-	6	---

SATA0 (J31)

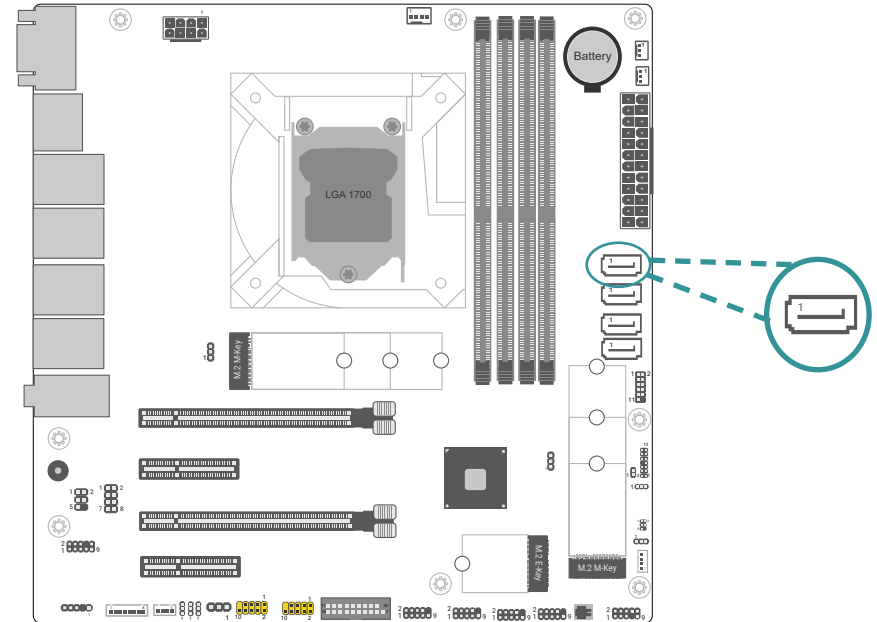

Pin	Assignment
1	GND
2	TX+
3	TX-
4	GND
5	RX-
6	RX+
7	GND

SATA1 (J17)

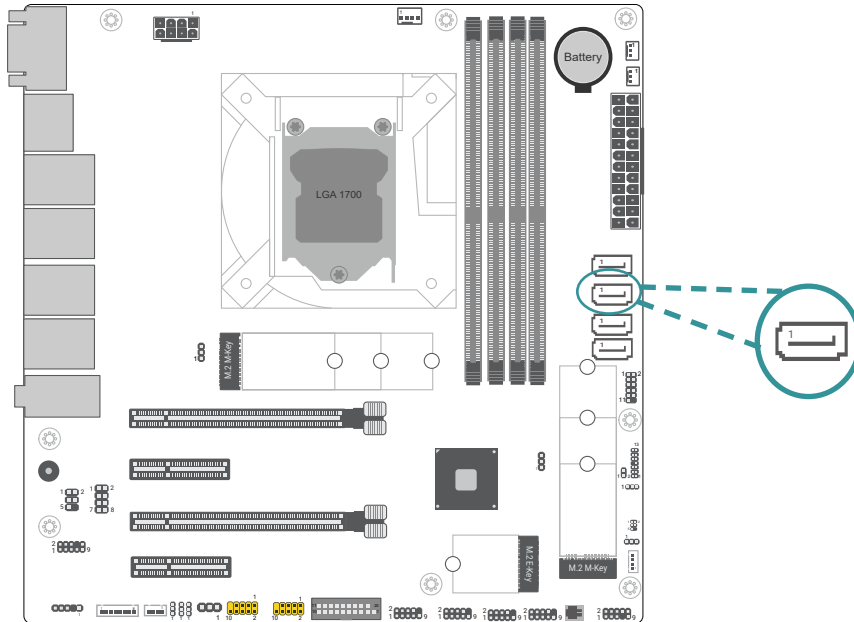

Pin	Assignment
1	GND
2	TX+
3	TX-
4	GND
5	RX-
6	RX+
7	GND

SATA2 (J32)

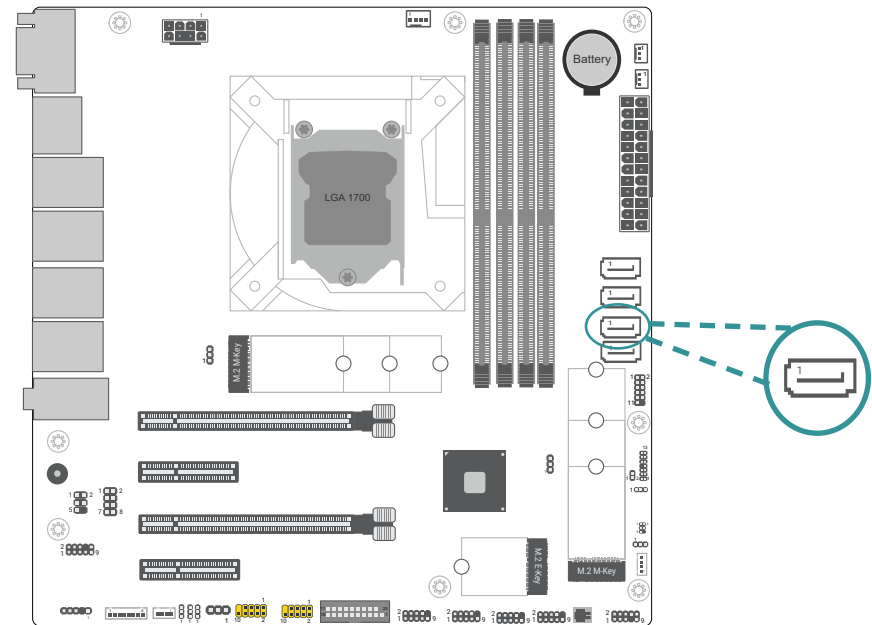

Pin	Assignment
1	GND
2	TX+
3	TX-
4	GND
5	RX-
6	RX+
7	GND

SATA3 (J31)

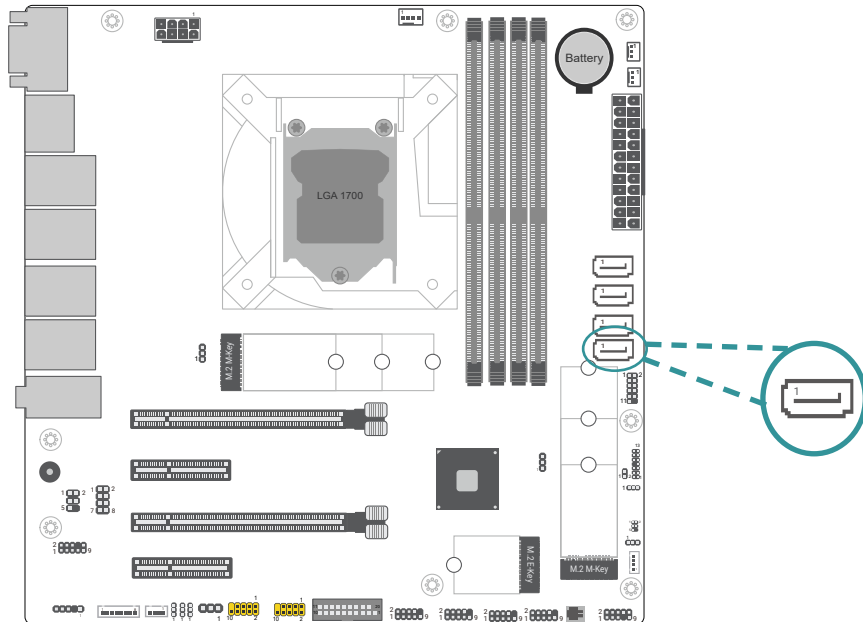

Pin	Assignment
1	GND
2	TX+
3	TX-
4	GND
5	RX-
6	RX+
7	GND

Front Panel (J18)

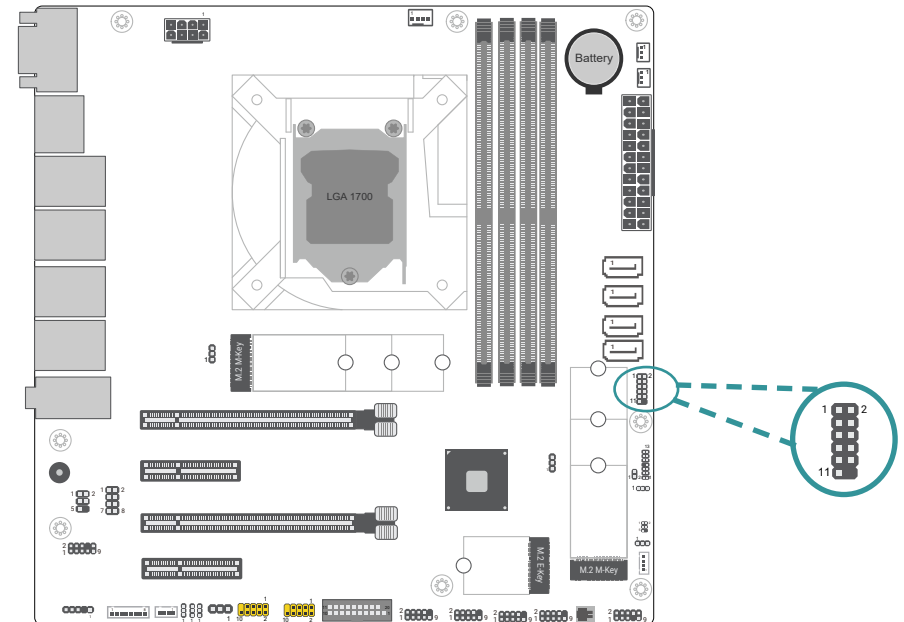

Pin	Assignment	Pin	Assignment
1	NC	2	V_SUS_LED
3	3V3	4	V_SUS_LED
5	HDD_LED	6	SUS_LED
7	GND	8	GND
9	SYS_RST-	10	PWR_BTN-
11	NC	12	---

ESPI Header (J35)

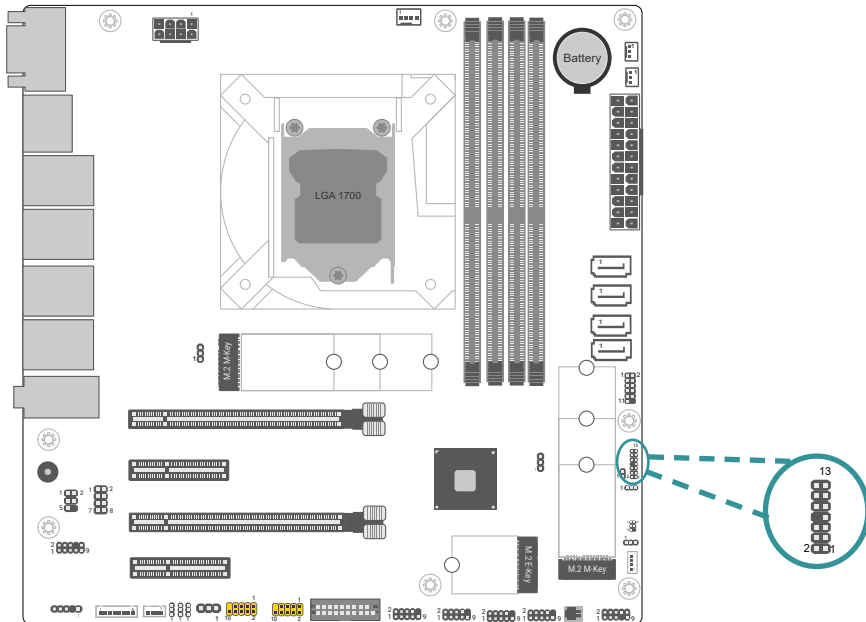

Pin	Assignment	Pin	Assignment
1	3V3SB	2	ESPI_CLK
3	ESPI_RESET#	4	GND
5	ESPI_ALT#	6	UART_TX
7	ESPI_D0	8	---
9	ESPI_D1	10	ESPI_CS
11	ESPI_D2	12	UART_RX
13	ESPI_D3	14	3V3SB

COM1 (TSJ1)

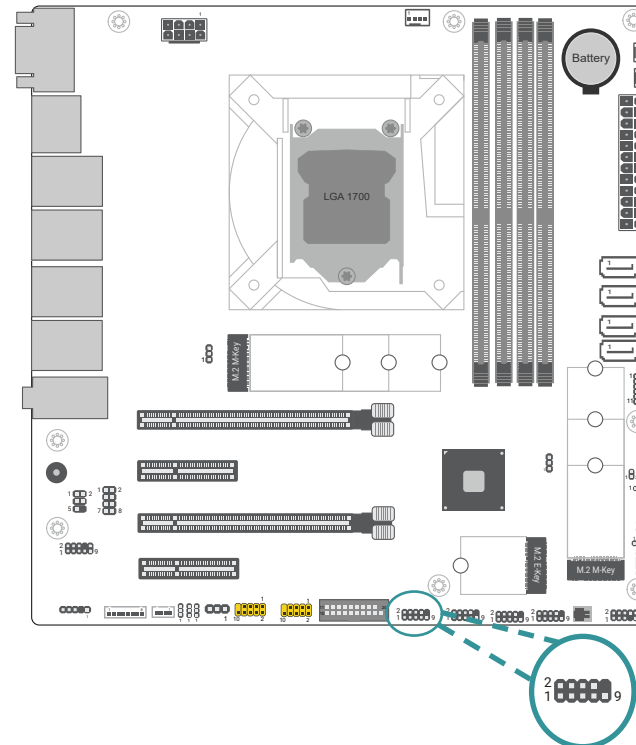

Pin	Assignment	Pin	Assignment
1	MDCD-	2	MSIN-
3	MSO-	4	MDTR-
5	GND	6	MDSR-
7	MRTS-	8	MCTS-
9	MRI-	10	----

COM2 (TSJ2)

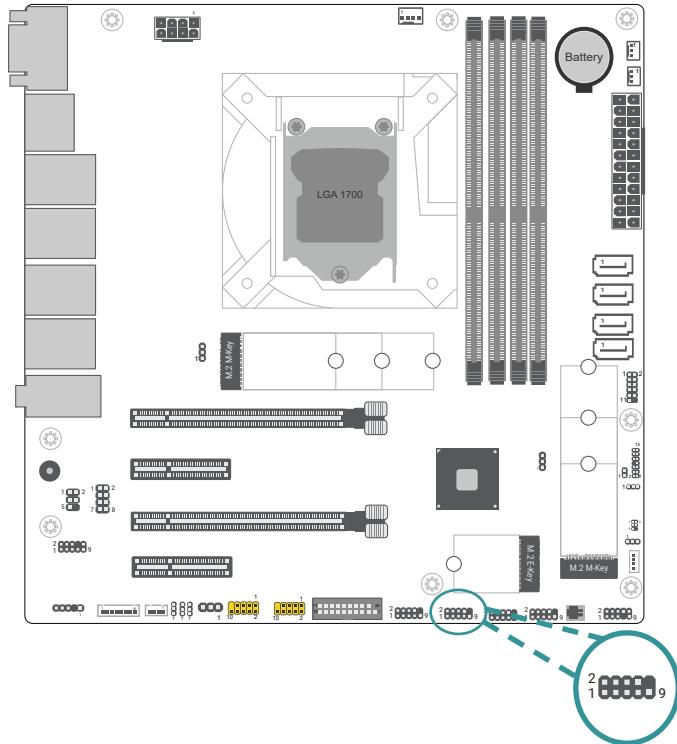

Pin	Assignment	Pin	Assignment
1	MDCD-	2	MSIN-
3	MSO-	4	MDTR-
5	GND	6	MDSR-
7	MRTS-	8	MCTS-
9	MRI-	10	----

COM3 (TSJ3)

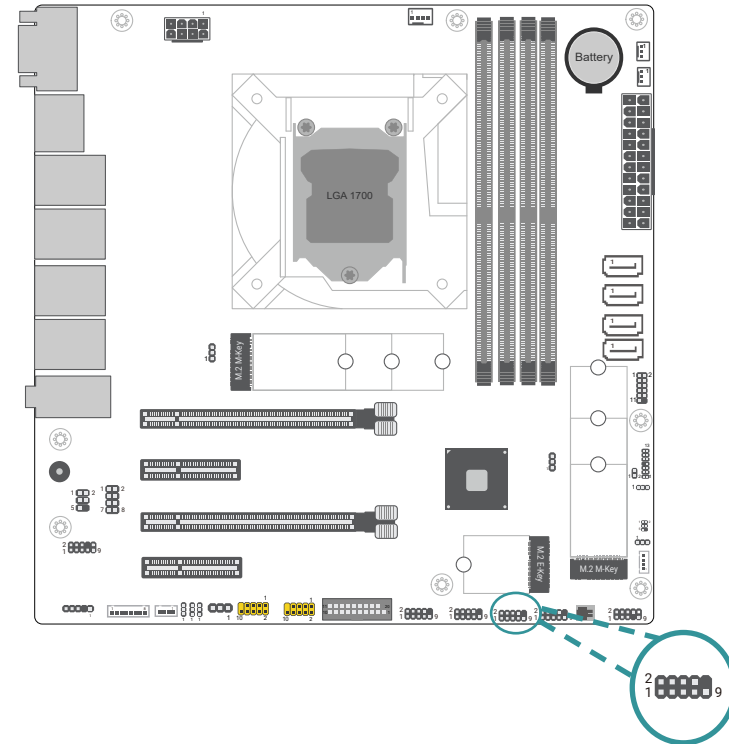

Pin	Assignment	Pin	Assignment
1	MDCD-	2	MSIN-
3	MSO-	4	MDTR-
5	GND	6	MDSR-
7	MRTS-	8	MCTS-
9	MRI-	10	----

COM4 (TSJ4)

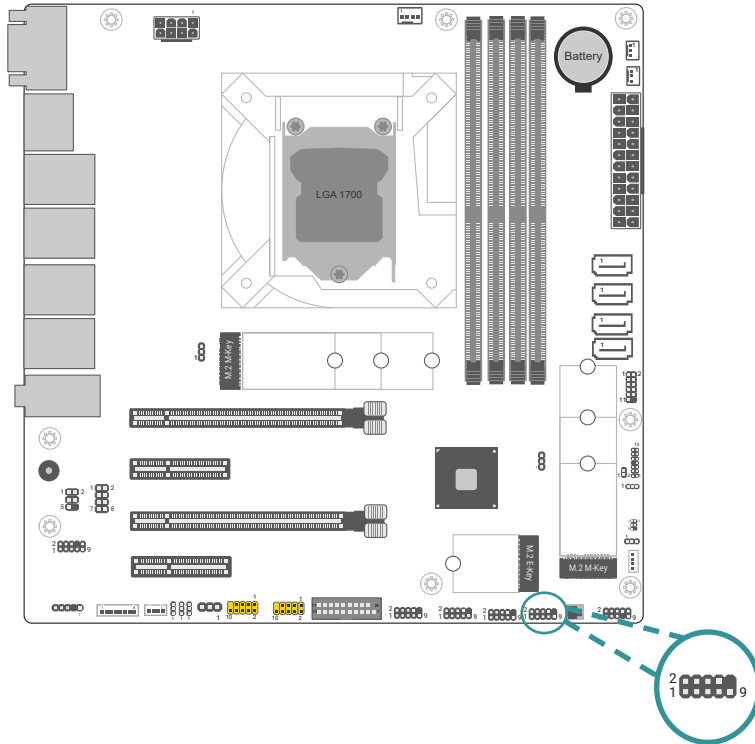

Pin	Assignment	Pin	Assignment
1	MDCD-	2	MSIN-
3	MSO-	4	MDTR-
5	GND	6	MDSR-
7	MRTS-	8	MCTS-
9	MRI-	10	----

DIO Power (J33)

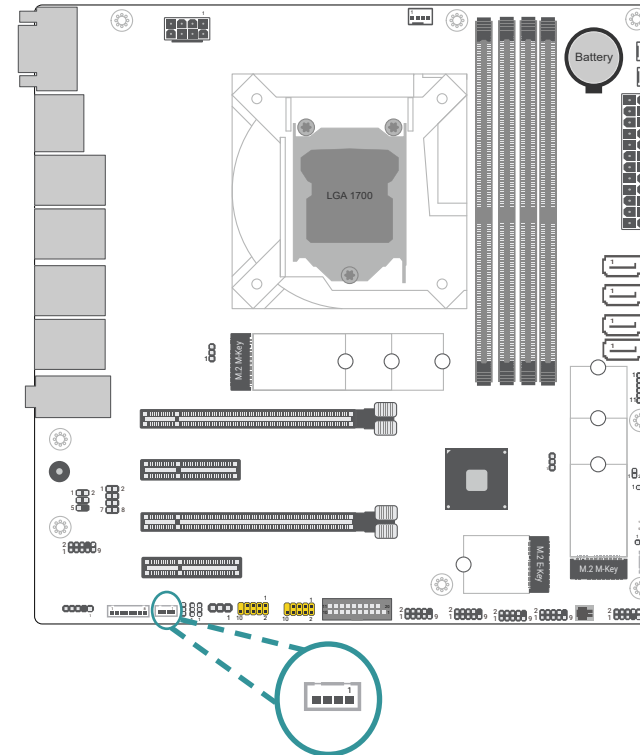

Pin	Assignment
1	12V
2	GND
3	5VDU
4	5V

DIO (J34)

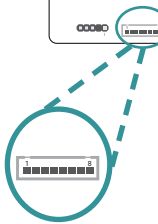
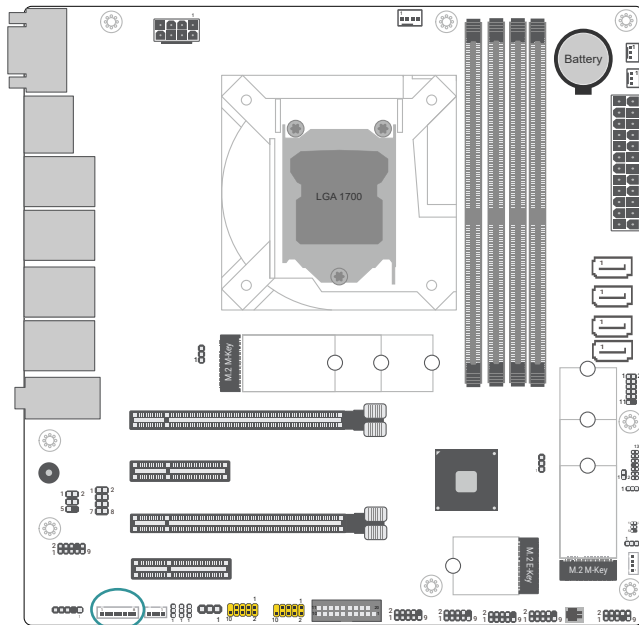

Pin	Assignment
1	DIO0
2	DIO1
3	DIO2
4	DIO3
5	DIO4
6	DIO5
7	DIO6
8	DIO7

► **System Memory**

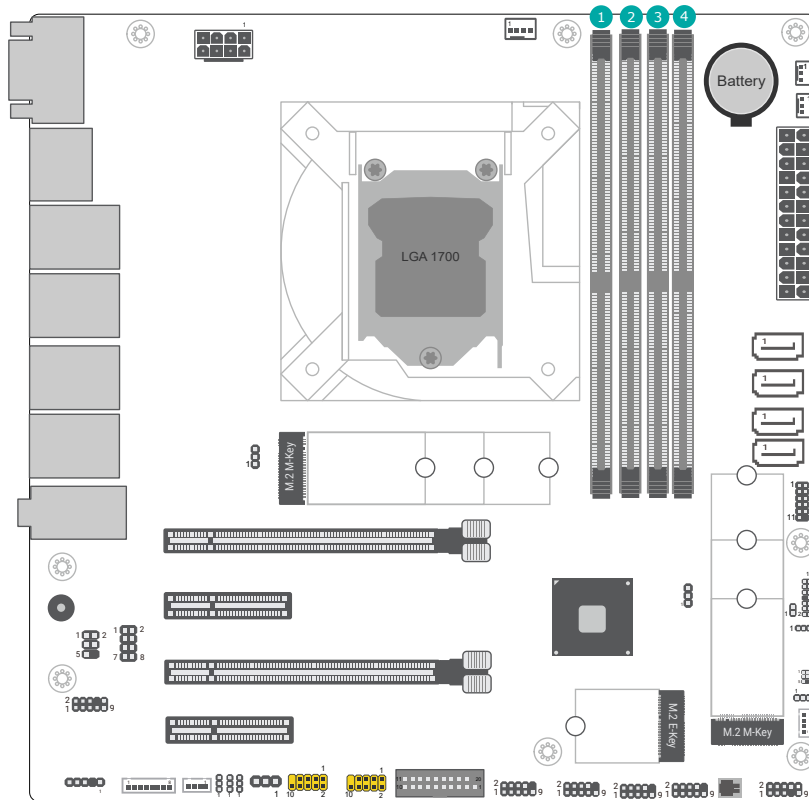

- 1 DIMM1

- 2 DIMM2

- 3 DIMM3

- 4 DIMM4

Installing the DIMM Module

Before installing the memory module, please make sure that the following safety cautions are well-attended.

1. Make sure the PC and all other peripheral devices connected to it has been powered down.
2. Disconnect all power cords and cables.
3. Locate the DIMM socket on the system board
4. Make sure the notch on memory card is aligned to the key on the socket.

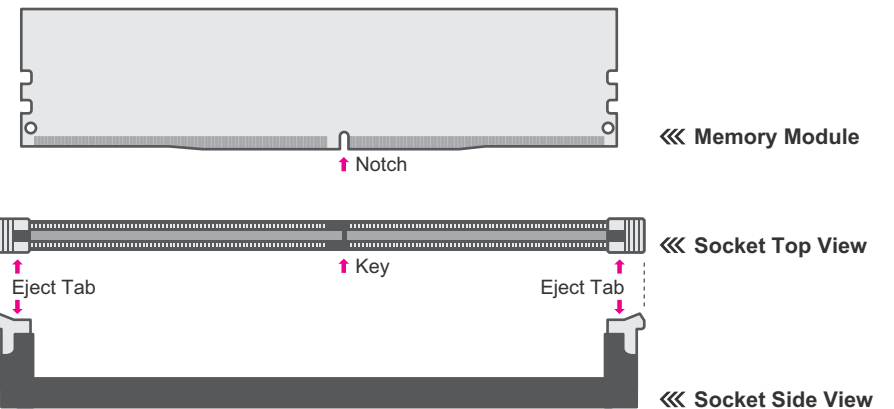

The system board supports the following memory interface.

Single Channel (SC)

Data will be accessed in chunks of 64 bits from the memory channels. DIMMs are on the same channel. DIMMs in a channel can be identical or completely different. However, we highly recommend using identical DIMMs. Not all slots need to be populated.

Dual Channel (DC)

Data will be accessed in chunks of 128 bits from the memory channels. Dual channel provides better system performance because it doubles the data transfer rate.

► **Expansion Slots**

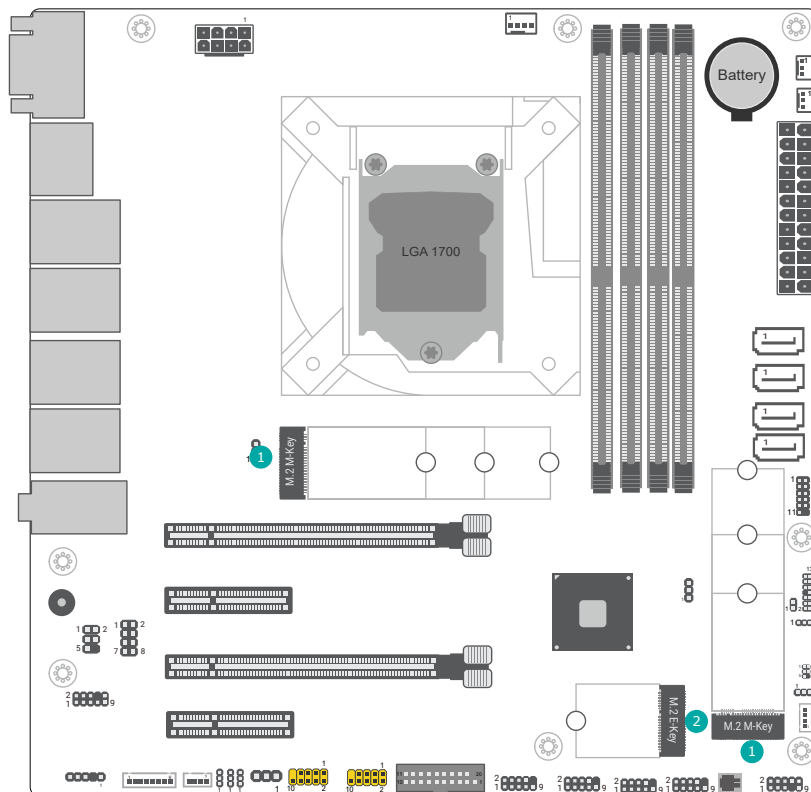

1 M.2 M-Key

2 M.2 E-Key

Installing the M.2 Module

Before installing the M.2 module into the M.2 socket, please make sure that the following safety cautions are well-attended.

1. Make sure the PC and all other peripheral devices connected to it has been powered down.
2. Disconnect all power cords and cables.
3. Locate the M.2 socket on the system board
4. Make sure the notch on card is aligned to the key on the socket.
5. Make sure the standoff screw is removed from the standoff.

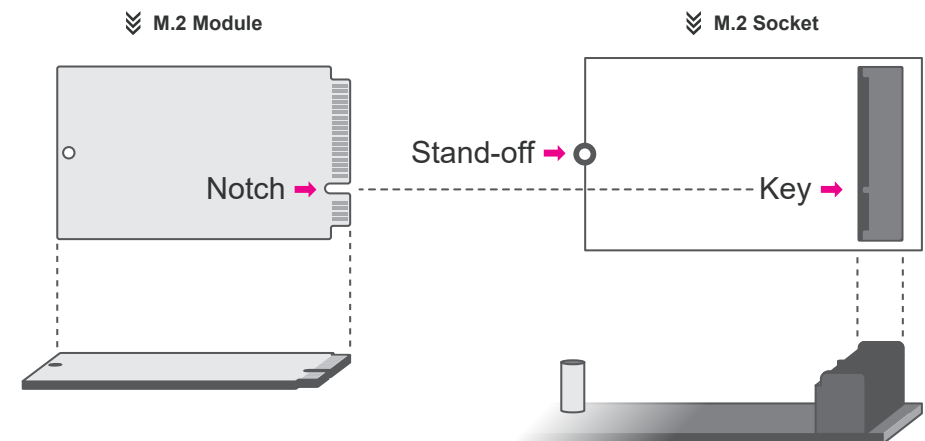

Please follow the steps below to install the card into the socket.

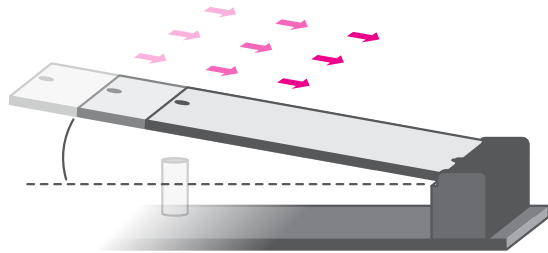

Step 1:
Insert the card into the socket at an angle while making sure the notch and key are perfectly aligned.

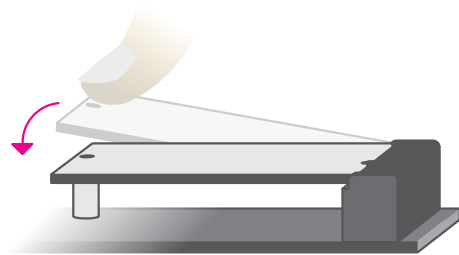

Step 2:
Press the end of the card far from the socket down until against the stand-off.



Step 3:
Screw tight the card onto the stand-off with a screw driver and a stand-off screw until the gap between the card and the stand-off closes up. The card should be lying parallel to the board when it's correctly mounted.

Chapter 3 - BIOS Settings

► Overview

The BIOS is a program that takes care of the basic level of communication between the CPU and peripherals. It contains codes for various advanced features found in this system board. The BIOS allows you to configure the system and save the configuration in a battery-backed CMOS so that the data retains even when the power is off. In general, the information stored in the CMOS RAM of the EEPROM will stay unchanged unless a configuration change has been made such as a hard drive replaced or a device added. It is possible that the CMOS battery will fail causing CMOS data loss. If this happens, you need to install a new CMOS battery and reconfigure the BIOS settings.



Note:

The BIOS is constantly updated to improve the performance of the system board; therefore the BIOS screens in this chapter may not appear the same as the actual one. These screens are for reference purpose only.

Default Configuration

Most of the configuration settings are either predefined according to the Load Optimal Defaults settings which are stored in the BIOS or are automatically detected and configured without requiring any actions. There are a few settings that you may need to change depending on your system configuration.

Entering the BIOS Setup Utility

The BIOS Setup Utility can only be operated from the keyboard and all commands are keyboard commands. The commands are available at the right side of each setup screen. The BIOS Setup Utility does not require an operating system to run. After you power up the system, the BIOS message appears on the screen and the memory count begins. After the memory test, the message "Press DEL to run setup" will appear on the screen. If the message disappears before you respond, restart the system or press the "Reset" button. You may also restart the system by pressing the <Ctrl> <Alt> and keys simultaneously.

Legends

Keys	Function
Right / Left arrow	Move the highlight left or right to select a menu
Up / Down arrow	Move the highlight up or down between submenus or fields
<Enter>	Enter the highlighted submenu
+ (plus key)/F6	Scroll forward through the values or options of the highlighted field
- (minus key)/F5	Scroll backward through the values or options of the highlighted field
<F1>	Display general help
<F2>	Display previous values
<F7>	Popup Boot Device List
<F9>	Optimized defaults
<F10>	Save and Exit
<Esc>	Return to previous menu

Scroll Bar

When a scroll bar appears to the right of the setup screen, it indicates that there are more available fields not shown on the screen. Use the up and down arrow keys to scroll through all the available fields.

Submenu

When "►" appears on the left of a particular field, it indicates that a submenu which contains additional options are available for that field. To display the submenu, move the highlight to that field and press <Enter>.

► Main

The Main menu is the first screen that you will see when you enter the BIOS Setup Utility.

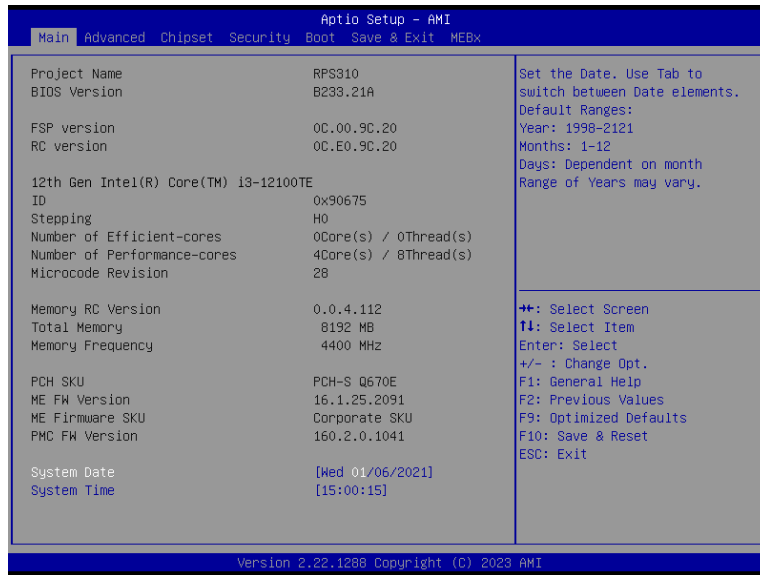

System Date

The date format is <month>, <date>, <year>. Press "Tab" to switch to the next field and press "-" or "+" to modify the value.

System Time

The time format is <hour>, <minute>, <second>. The time is based on the 24-hour military-time clock. For example, 1 p.m. is 13:00:00. Hour displays hours from 00 to 23. Minute displays minutes from 00 to 59. Second displays seconds from 00 to 59.

► Advanced

The Advanced menu allows you to configure your system for basic operation. Some entries are defaults required by the system board, while others, if enabled, will improve the performance of your system or let you set some features according to your preference.



Important:
Setting incorrect field values may cause the system to malfunction.

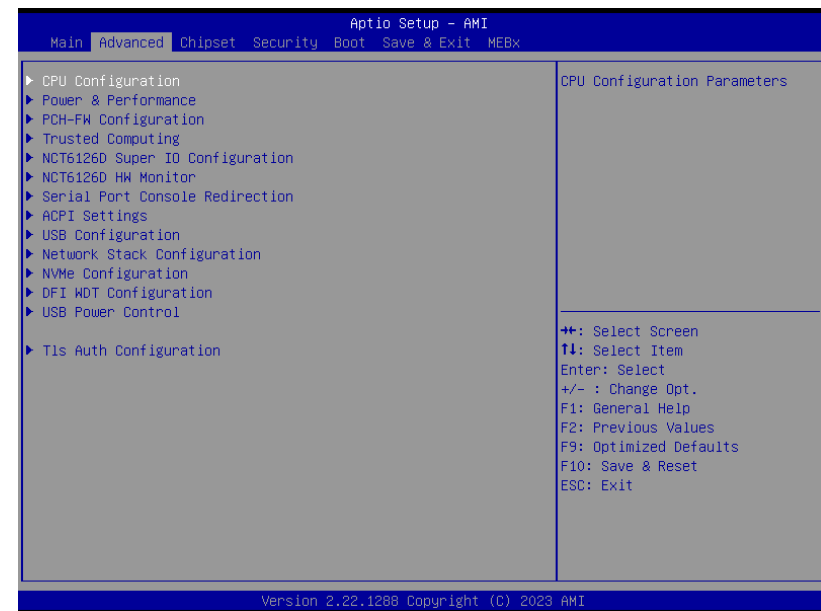

▶ Advanced

CPU Configuration

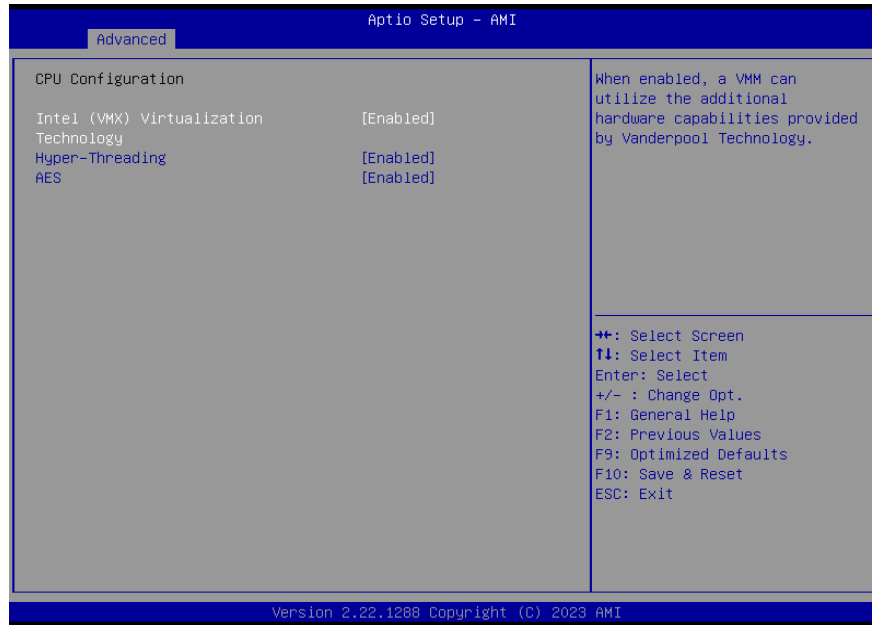

Intel (VMX) Virtualization Technology

When this field is set to Enabled, the VMM can utilize the additional hardware capabilities provided by Vanderpool Technology.

Hyper-threading

Enables this field for Windows XP and Linux which are optimized for Hyper-Threading technology. Select disabled for other OSes not optimized for Hyper-Threading technology. When disabled, only one thread per enabled core is enabled.

AES

Enable / Disable AES (Advanced Encryption Standard)

▶ Advanced

Power & Performance

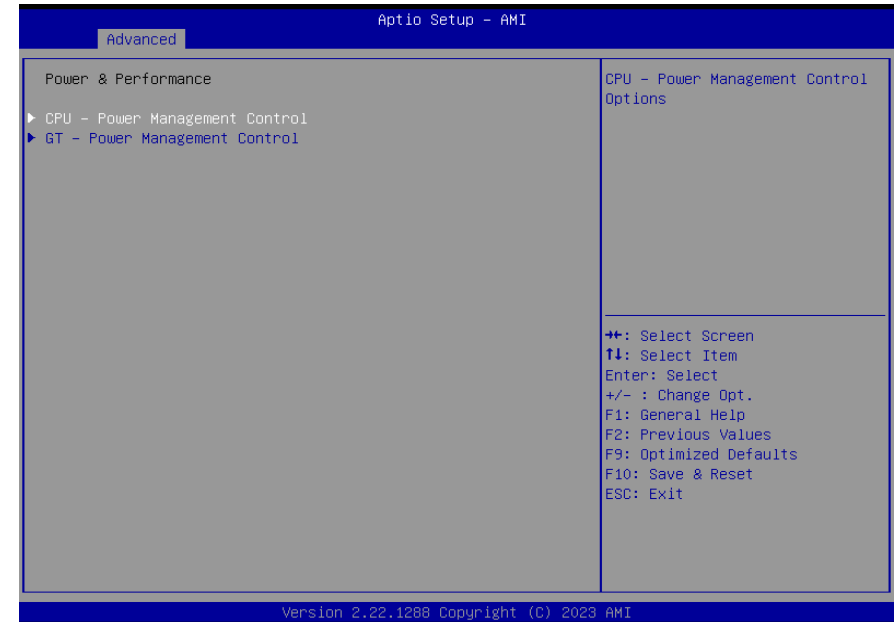

▶ Advanced

Power & Performance ▶ CPU- Power Management Control

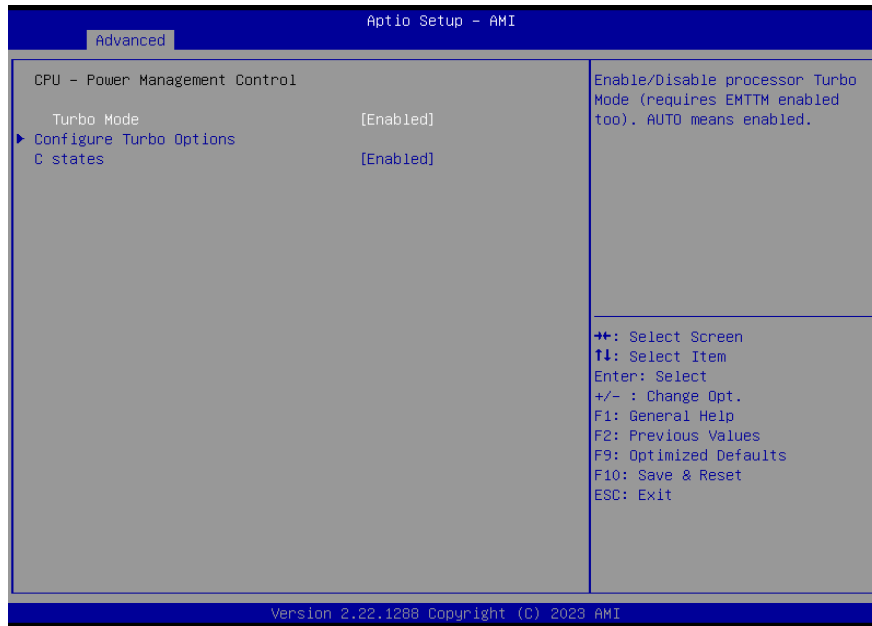

Turbo Mode

Enable or disable turbo mode of the processor. This field will only be displayed when EIST is enabled.

C states

Enable or disable CPU Power Management. It allows CPU to enter "C states" when it's idle and nothing is executing.

▶ Advanced

Power & Performance ▶ GT- Power Management Control

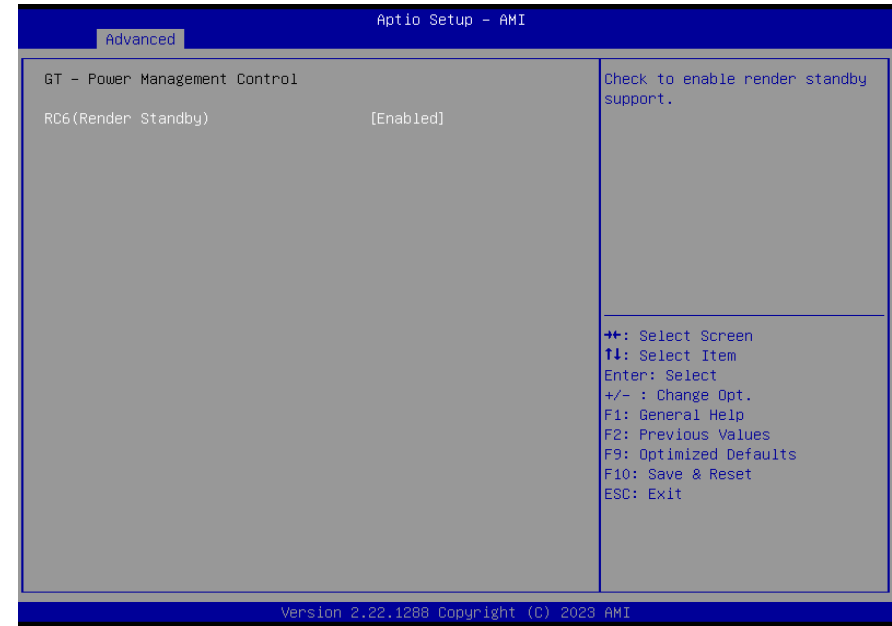

RC6 (Render Standby)

Check to enable render standby support.

► **Advanced**

PCH-FW Configuration

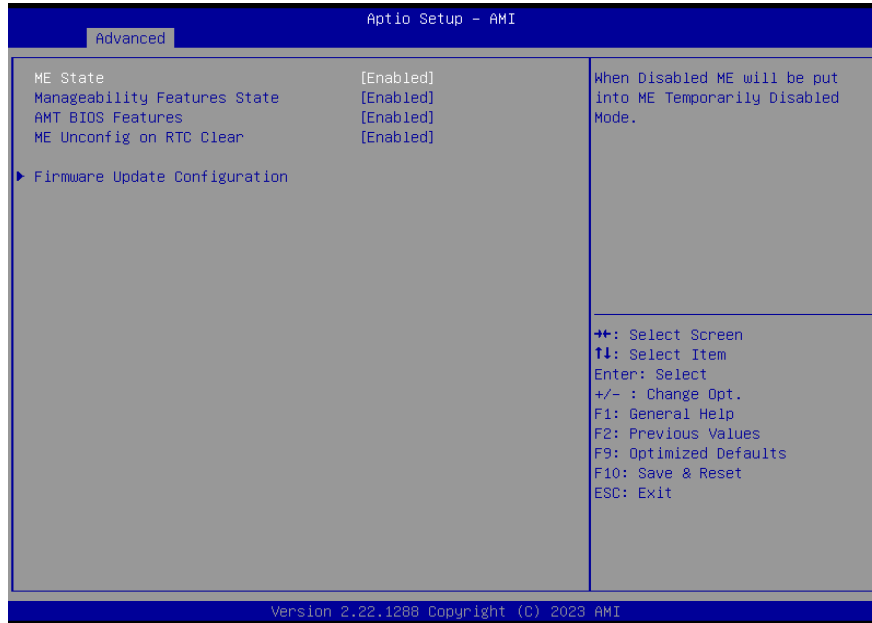

ME State

When this field is set to Disabled, ME will be put into ME Temporarily Disabled Mode.

Manageability Features State

Enable or disable Intel(R) Manageability features. This option disables/enables Manageability Features support in FW. To disable, support platform must be in an unprovisioned state first.

AMT BIOS Features

When disabled, AMT BIOS features are no longer supported and user is no longer able to access MEBx Setup. This option does not disable manageability features in FW.

ME Unconfig on RTC Clear

When disabled, ME will not be unconfigured on RTC Clear.

Firmware Update Configuration

Configure Management Engine Technology Parameters.



Note:
 The sub-menus are detailed in following sections.

▶ Advanced

Trusted Computing

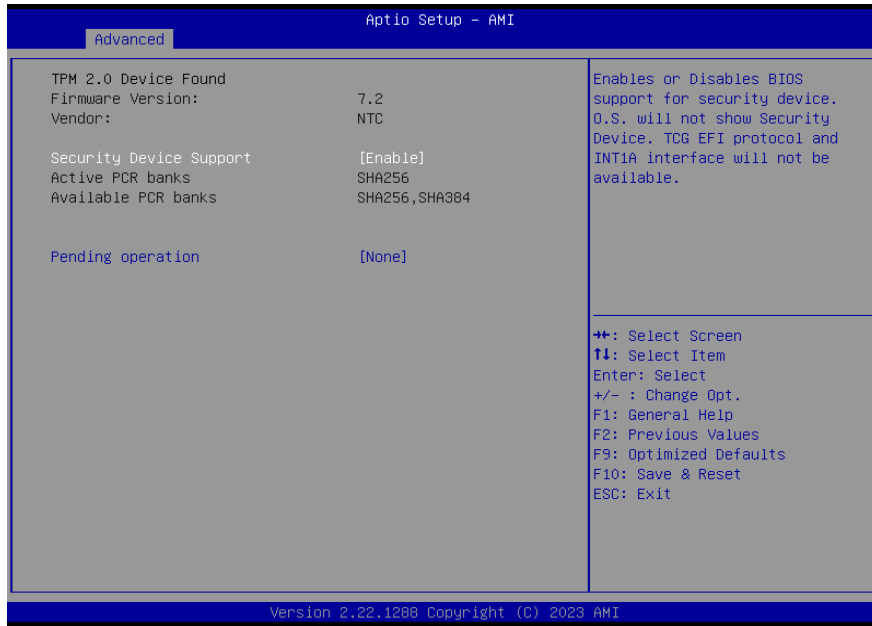

Security Device Support

This field is used to enable or disable BIOS support for the security device such as an TPM 2.0 to achieve hardware-level security via cryptographic keys.

Pending operation

To clear the existing TPM encryption, select "TPM Clear" and restart the system. This field is not available when "Security Device Support" is disabled.

▶ Advanced

NCT6126D Super IO Configuration

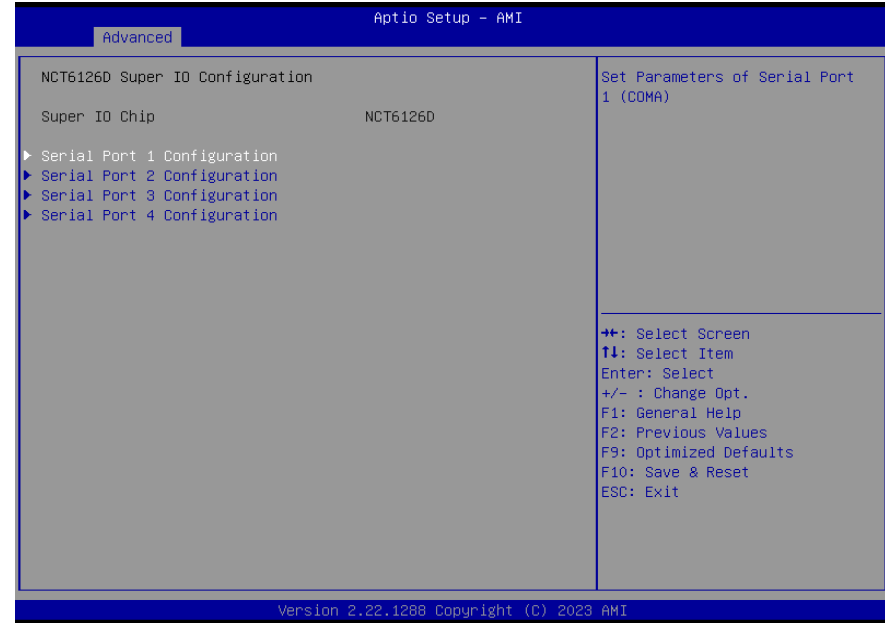

▶ Advanced

NCT6126D Super IO Configuration ▶ Serial Port 1, 2 Configuration

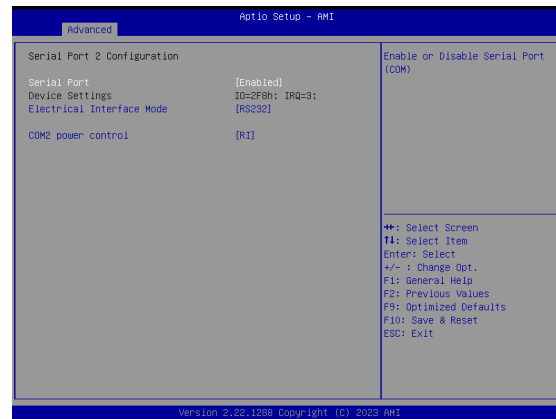
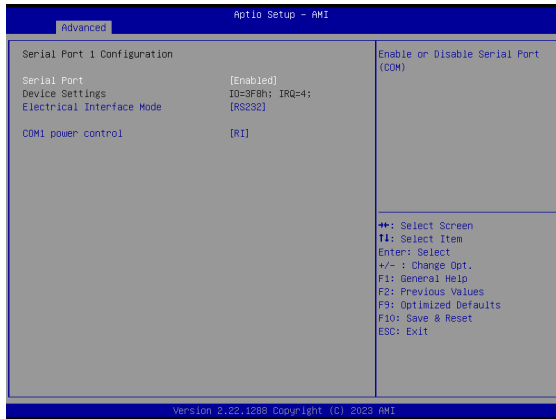

Serial Port
Enable or disable serial port.

▶ Advanced

NCT6126D Super IO Configuration ▶ Serial Port 3, 4 Configuration

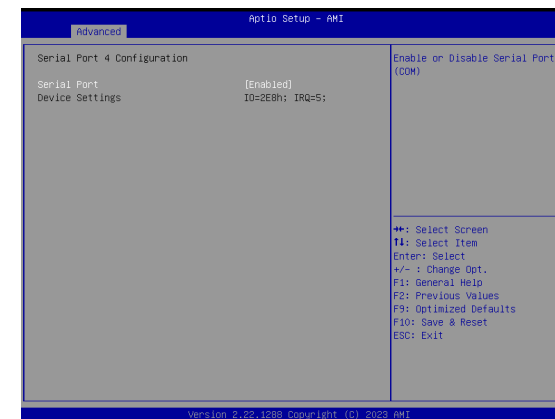

Serial Port
Enable or disable serial port.

► Advanced

NCT6126D HW Monitor

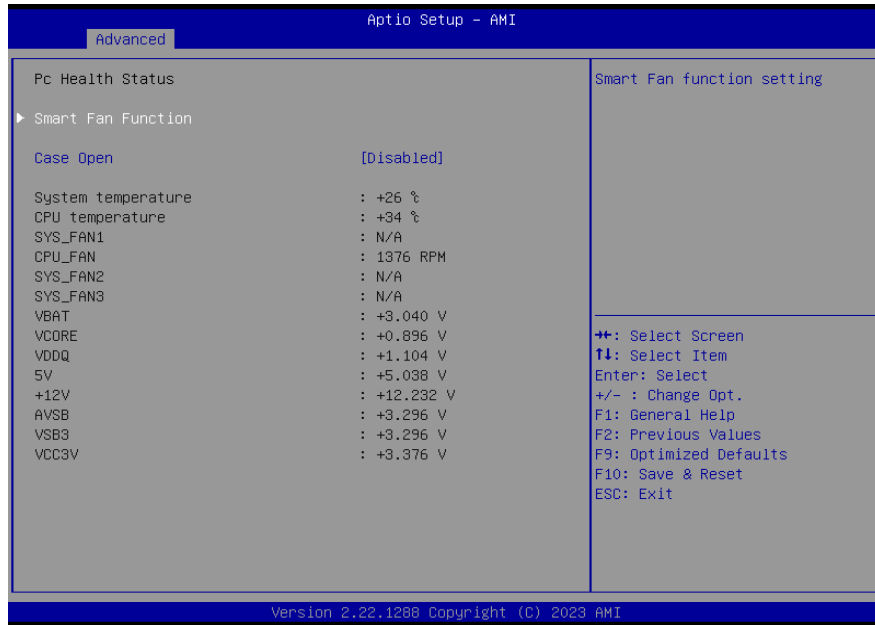

This section displays the system's health information, i.e. voltage readings, CPU and system temperatures, and fan speed readings

Smart Fan Function

Smart Fan Function Setting.

Case Open

Enable or disable the case open detection function.

► Advanced

NCT6126D HW Monitor ► Smart FAN Function



Smart Fan is a fan speed moderation strategy dependent on the current system temperature. When the system temperature goes higher than the Boundary setting, the fan speed will be turned up to the setting of the Fan Speed Count that bears the same index as the Boundary field.

SYS Smart Fan/CPU Smart Fan Control = [Enabled]

• **Boundary 1 to Boundary 4**

Set the boundary temperatures that determine the fan speeds accordingly, the value ranging from 0-127°C. For example, when the system temperature reaches Boundary 1 setting, the fan speed will be turned up to the designated speed of the Fan Speed Count 1 field.

• **Fan Speed Count 1 to Fan Speed Count 4**

Set the fan speed, the value ranging from 1-100%, 100% being full speed. The fans will operate according to the specified boundary temperatures above-mentioned.

▶ Advanced

Serial Port Console Redirection

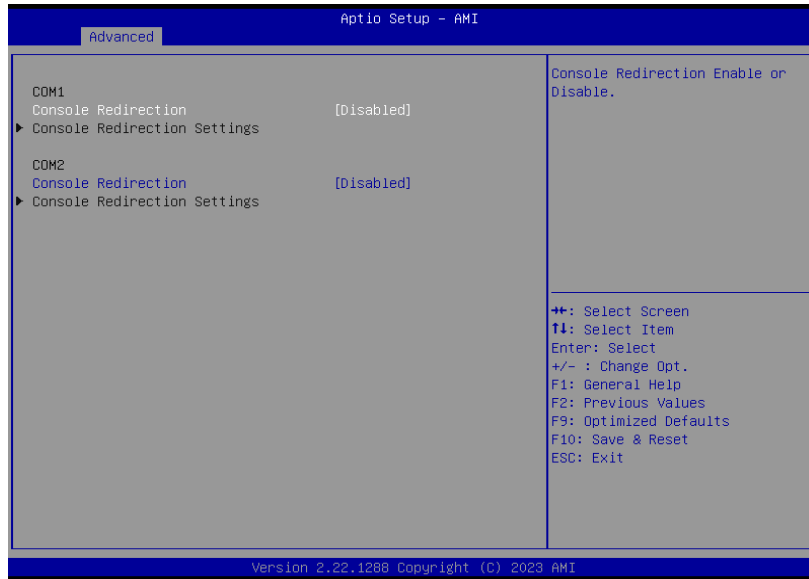

Console Redirection

By enabling Console Redirection of a COM port, the sub-menu of console redirection settings will become available for configuration as detailed in the following.

▶ Advanced

Serial Port Console Redirection ▶ Console Redirection Settings

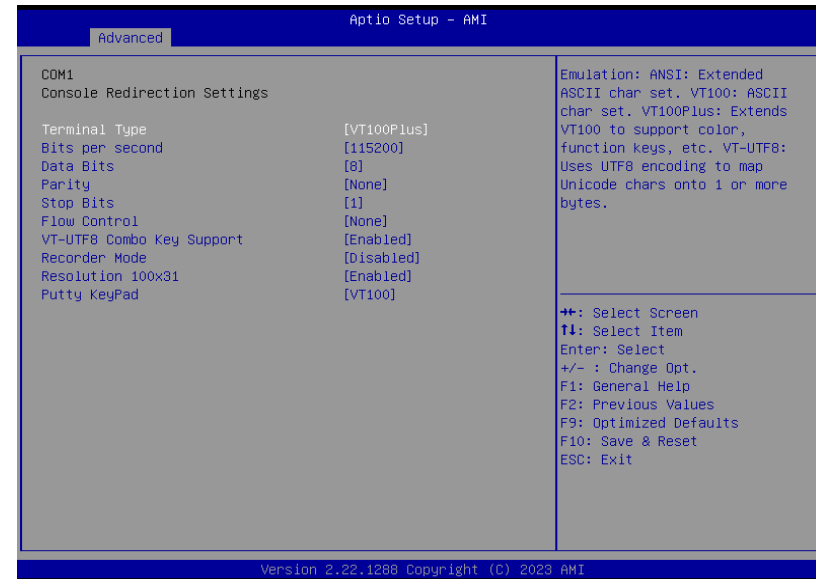

Configure the serial settings of the current COM port.

Terminal Type

Select terminal type: VT100, VT100+, VT-UTF8 or ANSI.

Bits per second

Select serial port transmission speed: 9600, 19200, 38400, 57600 or 115200.

Data Bits

Select data bits: 7 bits or 8 bits.

Parity

Select parity bits: None, Even, Odd, Mark or Space.

Stop Bits

Select stop bits: 1 bit or 2 bits.

Flow Control

Select flow control type: None or Hardware RTS/CTS. Flow Control is for RS485 mode and is only supported by Serial Port 1 (COM1).

VT-UTF8 Combo Key Support

Enable VT-UTF8 Combination Key Support for ANSI/VT100 terminals.

Recorder Mode

With this mode enabled only text will be sent. This is to capture Terminal data.

Resolution 100x31

Enables or disables extended terminal resolution

Putty KeyPad

Select FunctionKey and KeyPad on Putty.

▶ Advanced

ACPI Settings

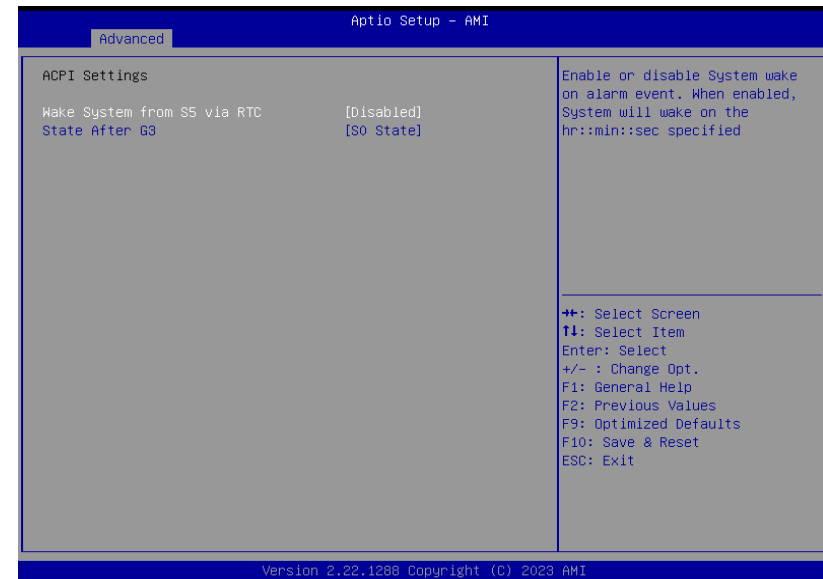

Wake system from S5 via RTC

When Enabled, the system will automatically power up at a designated time every day. Once it's switched to [Enabled], please set up the time of day — hour, minute, and second — for the system to wake up.

State After G3

Select between S0 State, and S5 State. This field is used to specify what state the system is set to return to when power is re-applied after a power failure (G3 state).

- **S0 State** The system automatically powers on after power failure.
- **S5 State** The system enter soft-off state after power failure. Power-on signal input is required to power up the system.

► **Advanced**

USB Configuration

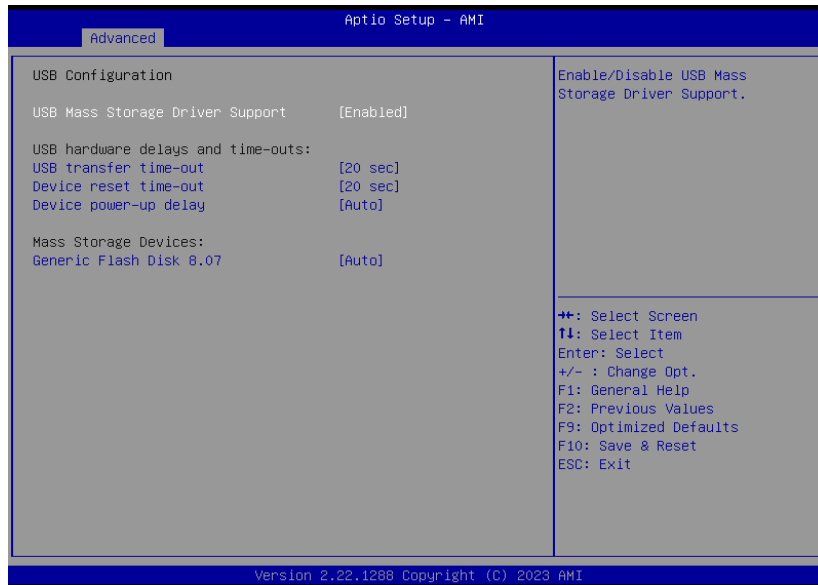

USB Mass Storage Driver Support

Enable or disable USB Mass Storage Driver Support.

USB hardware delays and time-outs

- **USB transfer time-out** The time-out value for **Control**, **Bulk**, and **Interrupt transfers**.
- **Device reset time-out** USB mass storage device Start Unit command time-out.
- **Device power-up delay** Maximum time the device will take before it properly reports itself to the Host Controller. 'Auto' uses default value: for a Root port it is 100 Ms, for a Hub port the delay is taken from Hub descriptor.

► **Advanced**

Network Stack Configuration

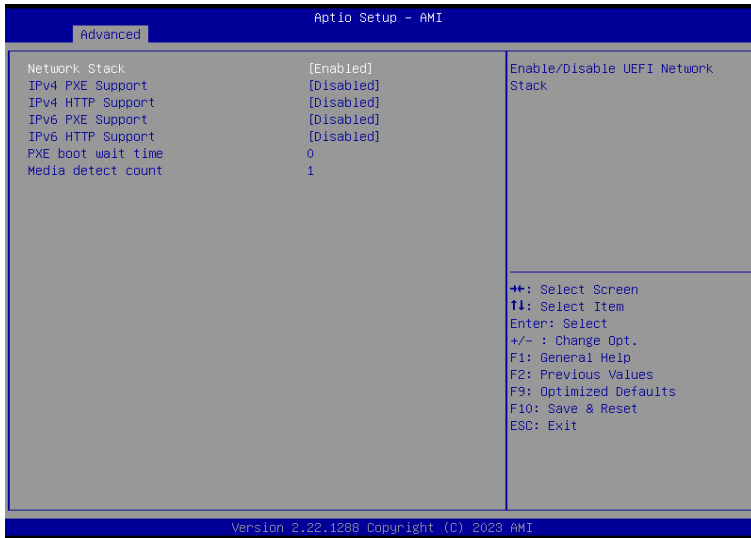

Network Stack

Enable or disable UEFI network stack. The following fields will appear when this field is enabled.

IPv4 PXE Support

Enable or disable IPv4 PXE boot support. If disabled, IPv4 PXE boot support will not be available.

IPv4 HTTP Support

Enable or disable IPv4 HTTP boot support. If disabled, IPv4 HTTP boot support will not be available.

IPv6 PXE Support

Enable or disable IPv6 PXE boot support. If disabled, IPv6 PXE boot support will not be available.

IPv6 HTTP Support

Enable or disable IPv6 HTTP boot support. If disabled, IPv6 HTTP boot support will not be available.

PXE boot wait time

Set the wait time in seconds to press ESC key to abort the PXE boot. Use either +/- or numeric keys to set the value.

Media detect count

Set the number of times the presence of media will be checked. Use either +/- or numeric keys to set the value.

▶ Advanced

DFI WDT Configuration

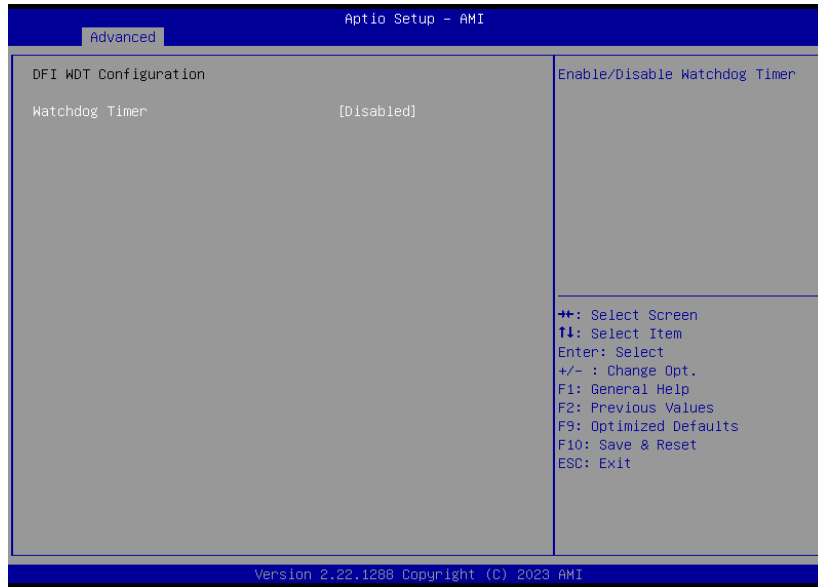

Watchdog Timer

Enable or disable Watchdog Timer.

▶ Advanced

USB Power Control

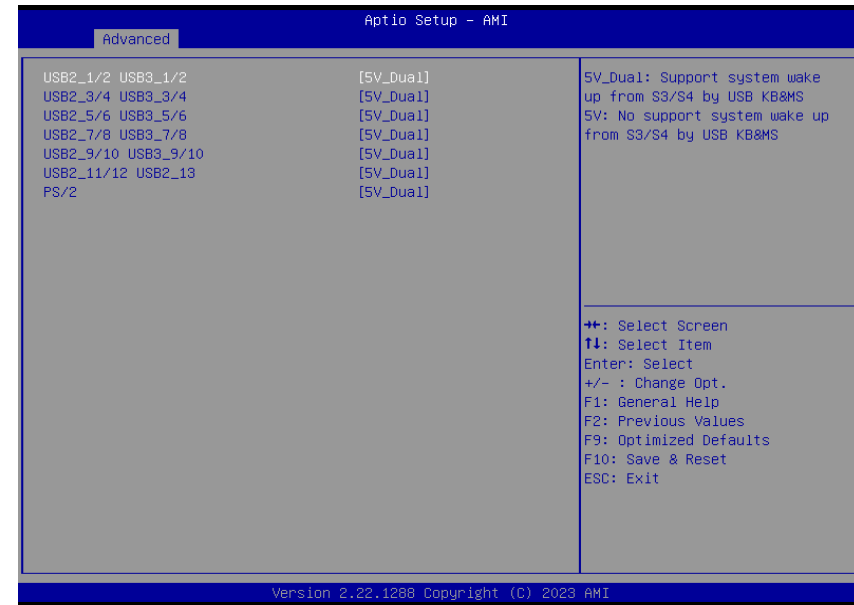

Server CA Configuration

5_Dual: Support system wake up from S3/S4 by USB KB&MS

5V: No support system wake up from S3/S4 by USB KB&MS

▶ Advanced

Tls Auth Configuration

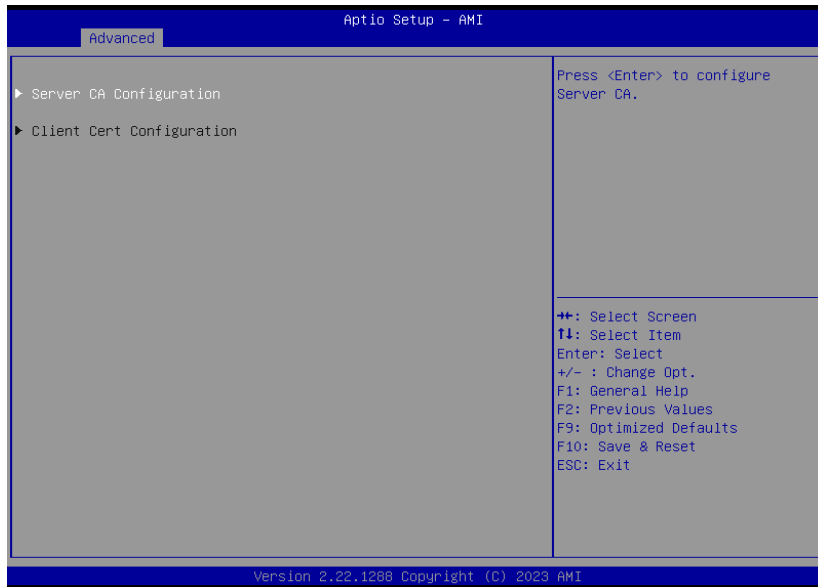

Server CA Configuration

Press <Enter> to configure Server CA.

► Chipset



Please select a submenu and press Enter. The submenus are detailed in the following pages.

► Chipset

System Agent (SA) Configuration

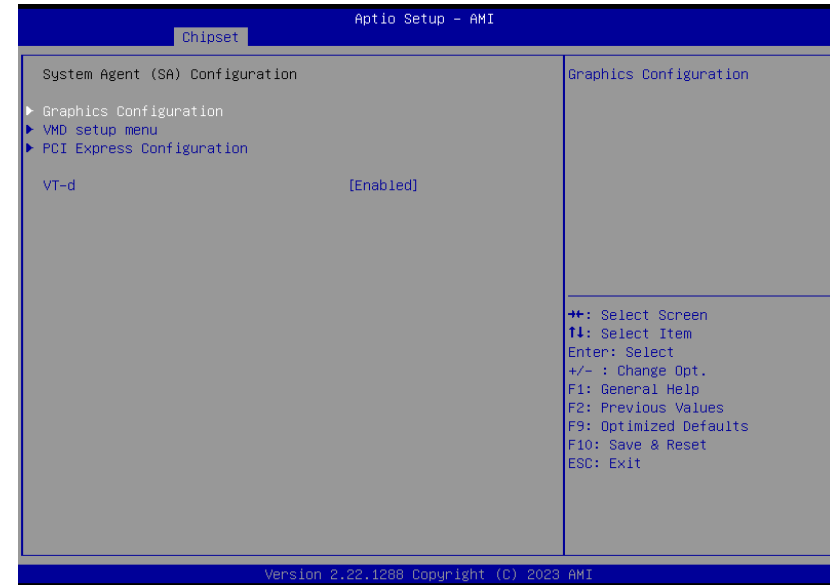

Graphics Configuration

Settings about graphic.

VMD setup menu

VMD Configuration Settings

PCI Express Configuration :

VT-d

VT-d capability.

▶ Chipset

PCH-IO Configuration



PCI Express Configuration

PCI Express Configuration Settings

SATA Configuration

SATA Device Options Settings

HD Audio Configuration

HD Audio Subsystem Configuration Settings

▶ Chipset

PCH-IO Configuration ▶ PCI Express Configuration

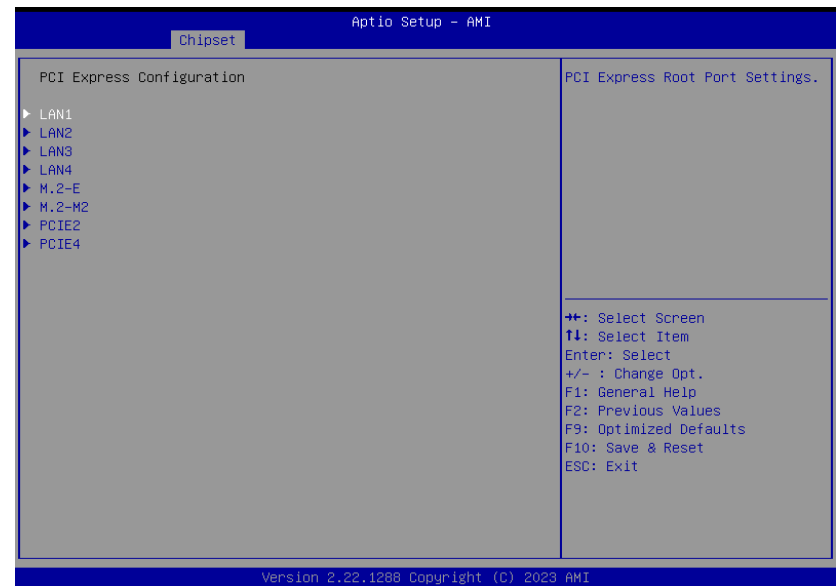

Select one of the PCI Express channels and press enter to configure the following settings.

LAN1, LAN2, LAN3, LAN4, M.2-E, M.2-M2, PCIE2, PCIE4

Control the PCI Express Root Port.

► Chipset

PCH-IO Configuration ► SATA Configuration

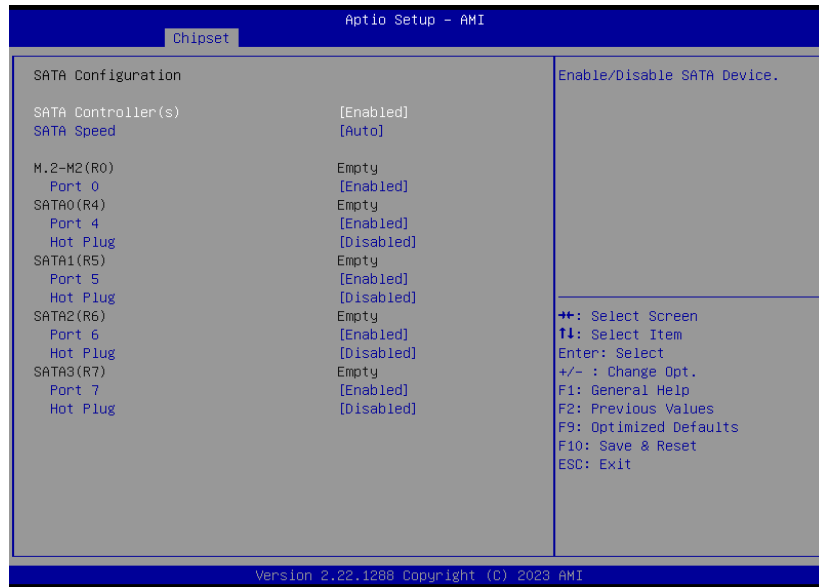

SATA Controller(s)

This field is used to enable or disable the Serial ATA controller.

SATA Speed

This field is used to select SATA speed generation limit: Auto, Gen1, Gen2 or Gen3.

Ports and Hot Plug

Enable or disable the Serial ATA port and its hot plug function.

► Chipset

PCH-IO Configuration ► HD Audio Configuration



HD Audio

Control the detection of the HD Audio device.

- **Disabled** HDA will be unconditionally disabled.
- **Enabled** HDA will be unconditionally enabled.

► Security

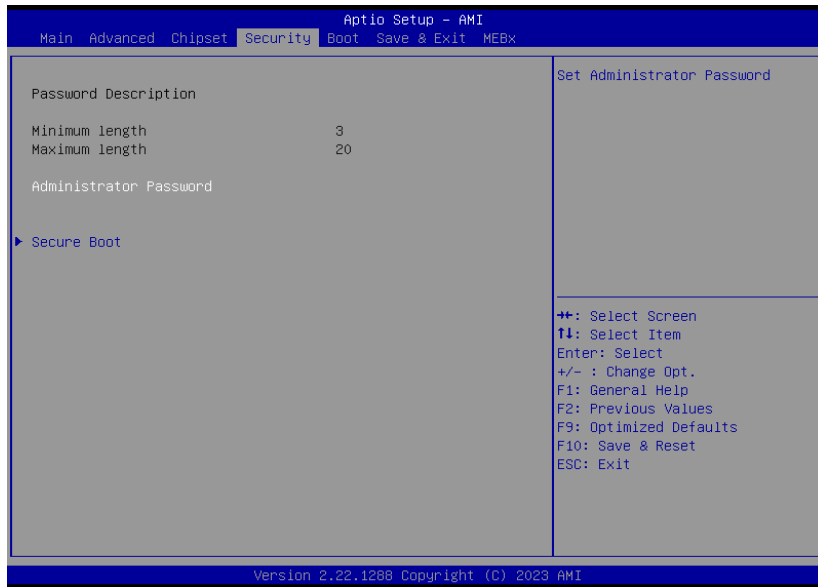

Administrator Password

Set the administrator password. To clear the password, input nothing and press enter when a new password is asked. Administrator Password will be required when entering the BIOS.

User Password

Set the user password. To clear the password, input nothing and press enter when a new password is asked. User Password will be required when powering up the system.

► Security

Secure Boot



Secure Boot

The Secure Boot store a database of certificates in the firmware and only allows the OSEs with authorized signatures to boot on the system. To activate Secure Boot, please make sure that "Secure Boot" is "[Enabled]", Platform Key (PK) is enrolled, "System Mode" is "User", and CSM is disabled. After enabling/disabling Secure Boot, please save the configuration and restart the system. When configured and activated correctly, the Secure Boot status will be "Active".

Secure Boot Mode

Select the secure boot mode – Standard or Custom. When set to Custom, the following fields will be configurable for the user to manually modify the key database.

Restore Factory Keys

Force system to User Mode. Load OEM-defined factory defaults of keys and databases onto the Secure Boot. Press Enter and a prompt will show up for you to confirm.

Reset To Setup Mode

Clear the database from the NVRAM, including all the keys and signatures installed in the Key Management menu. Press Enter and a prompt will show up for you to confirm.

Key Management

Enables expert users to modify Secure Boot Policy variables without full authentication.

► Boot

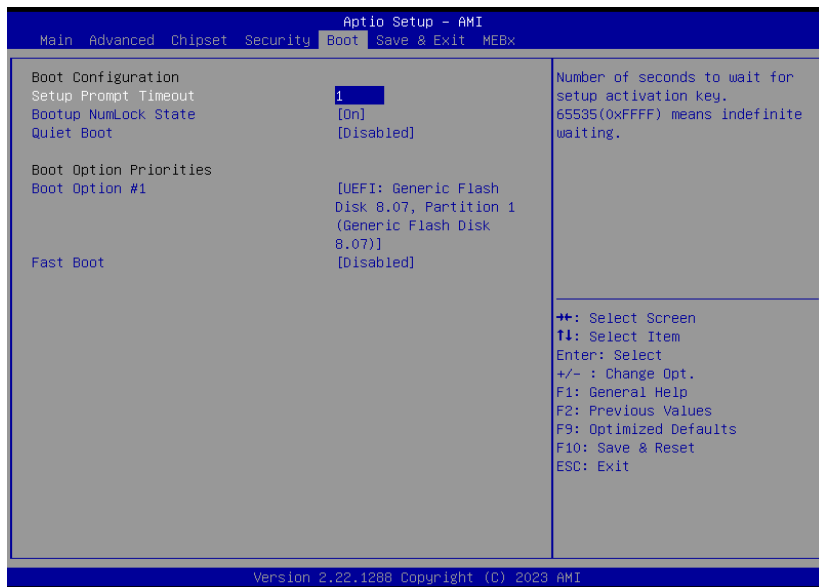

Setup Prompt Timeout

Set the number of seconds to wait for the setup activation key. 65535 (0xFFFF) denotes indefinite waiting.

Bootup NumLock State

Select the keyboard NumLock state: On or Off.

Quiet Boot

This section is used to enable or disable quiet boot option.

Boot Option Priorities

Rearrange the system boot order of available boot devices.



Note:

If “Boot option filter” of “CSM Configuration” is set to “UEFI and Legacy” or “UEFI only”, and “Quiet Boot” is set to enabled, “BGRT Logo” will show up for configuration. Refer to the Advanced > CSM Configuration submenu for more information.

► Save & Exit



Save Changes and Reset

To save the changes, select this field and then press <Enter>. A dialog box will appear. Select Yes to reset the system after saving all changes made.

Discard Changes and Reset

To discard the changes, select this field and then press <Enter>. A dialog box will appear. Select Yes to reset the system setup without saving any changes.

Restore Defaults

To restore and load the optimized default values, select this field and then press <Enter>. A dialog box will appear. Select Yes to restore the default values of all the setup options.

Boot Override

Move the cursor to an available boot device and press Enter, and then the system will immediately boot from the selected boot device. The Boot Override function will only be effective for the current boot. The “Boot Option Priorities” configured in the Boot menu will not be changed.

- **Save Setting to file** Select this option to save BIOS configuration settings to a USB flash device.
- **Restore Setting from file** This field will appear only when a USB flash device is detected. Select this field to restore setting from the USB flash device.

► MEBx

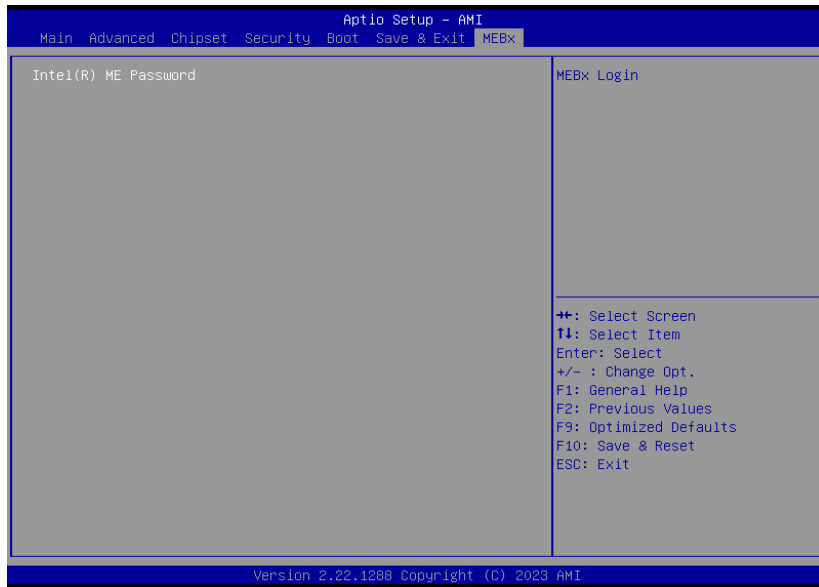

► Updating the BIOS

To update the BIOS, you will need the new BIOS file and a flash utility. Please contact technical support or your sales representative for the files and specific instructions about how to update BIOS with the flash utility.

► Notice: BIOS SPI ROM

1. The Intel® Management Engine has already been integrated into this system board. Due to the safety concerns, the BIOS (SPI ROM) chip cannot be removed from this system board and used on another system board of the same model.
2. The BIOS (SPI ROM) on this system board must be the original equipment from the factory and cannot be used to replace one which has been utilized on other system boards.
3. If you do not follow the methods above, the Intel® Management Engine will not be updated and will cease to be effective.



Note:

- a. You can take advantage of flash tools to update the default configuration of the BIOS (SPI ROM) to the latest version anytime.
- b. When the BIOS IC needs to be replaced, you have to populate it properly onto the system board after the EEPROM programmer has been burned and follow the technical person's instructions to confirm that the MAC address should be burned or not.
- c. After updating unique MAC Address from manufacturing, NVM will be protected immediately after power cycle. Users cannot update NVM or MAC address.

Chapter 4 - RAID Settings

The system board allows configuring RAID on Serial ATA drives. It supports RAID 0, RAID 1, RAID 5 and RAID 10.

► RAID Levels

RAID 0 (Striped Disk Array without Fault Tolerance)

RAID 0 uses two new identical hard disk drives to read and write data in parallel, interleaved-stacks. Data is divided into stripes and each stripe is written alternately between two disk drives. This improves the I/O performance of the drives at different channel; however it is not fault tolerant. A failed disk will result in data loss in the disk array.

RAID 1 (Mirroring Disk Array with Fault Tolerance)

RAID 1 copies and maintains an identical image of the data from one drive to the other drive. If a drive fails to function, the disk array management software directs all applications to the other drive since it contains a complete copy of the drive's data. This enhances data protection and increases fault tolerance to the entire system. Use two new drives or an existing drive and a new drive but the size of the new drive must be the same or larger than the existing drive.

RAID 5

RAID 5 stripes data and parity information across hard drives. It is fault tolerant and provides better hard drive performance and more storage capacity.

RAID 10 (Mirroring and Striping)

RAID 10 is a combination of data striping and data mirroring providing the benefits of both RAID 0 and RAID 1. Use four new drives or an existing drive and three new drives for this configuration.

RAID Level	Min. Drives	Protection	Description
RAID 0	2	None	Data striping without redundancy
RAID 1	2	Single Drive Failure	Disk mirroring
RAID 5	3	Single Drive Failure	Block-level data striping with distributed parity
RAID 10	4	1 Disk Per Mirrored Stripe (not same mirror)	Combination of RAID 0 (data striping) and RAID 1 (mirroring)



Note:

M.2 PCIe SSD cannot be used to set up a RAID set either with an M.2 SATA SSD or a SATA hard drive.

► Setup Procedure

To enable the RAID function, the following settings are required.

1. Install SATA drives.
2. Enable RAID in the Insyde BIOS.
3. Create a RAID volume.
4. Install the Intel Rapid Storage Technology Utility.

Step 1: Install SATA Drives

Refer to chapter 2 for details on connecting the Serial ATA drives.



Important:

1. Please make sure the SATA drives that you are to create a RAID volume with are connected and powered, and are able to be detected by the system. Otherwise, the RAID BIOS utility would not be accessible.
2. While creating a RAID volume, please make sure the system, drives, and cables are perfectly steady and mounted correctly. Disturbance during creating a RAID volume will result in irreversible data corruption stored on the drive.

Step 2: Create a RAID Volume

1. Go to the "Advanced" menu of the AMI BIOS and select "Intel(R) Rapid Storage Technology".
2. The screen displays all available drives. Select "Create RAID volume" to create a RAID volume".
3. Use the up or down arrow keys to select the RAID level and press <Enter>.
4. Use the up or down arrow keys to scroll through the list of hard drives and press <Enter> to select the drive.
5. Press <Enter>.
6. Use the up or down arrow keys to select the strip size and press <Enter>.
7. Enter the volume size and press <Enter>.
8. At the prompt, press <Y> to confirm volume creation.

Step 3: Install the Intel Rapid Storage Technology Utility

The Intel Rapid Storage Technology Utility can be installed from within Windows. It allows RAID volume management (create, delete, migrate) from within the operating system. It will also display useful SATA device and RAID volume information. The user interface, tray icon service and monitor service allow you to monitor the current status of the RAID volume and/or SATA drives. It enables enhanced performance and power management for the storage subsystem.

► How to enable Intel(R) Rapid Storage Technology in BIOS

System Agent (SA) Configuration ► VMD Setup Menu

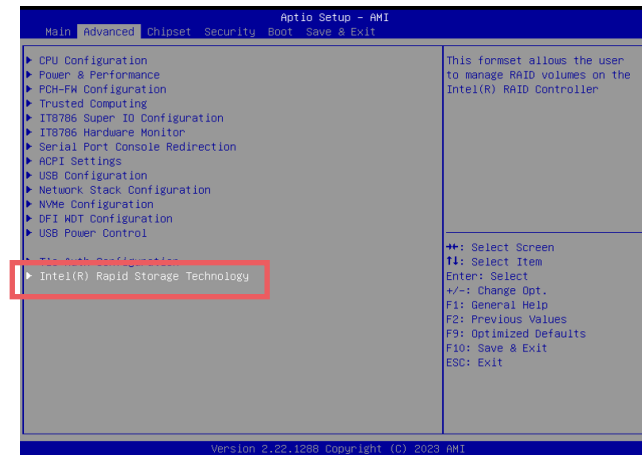
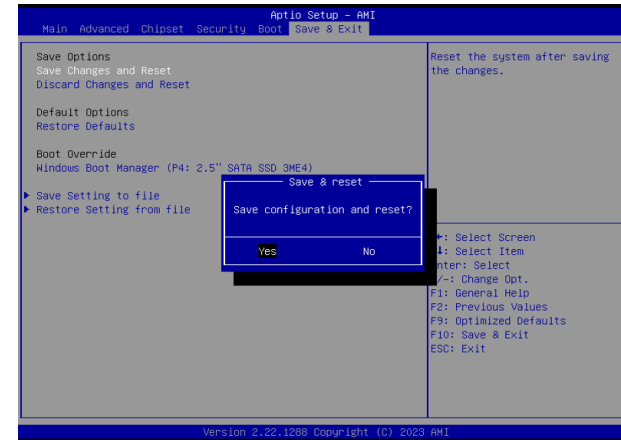
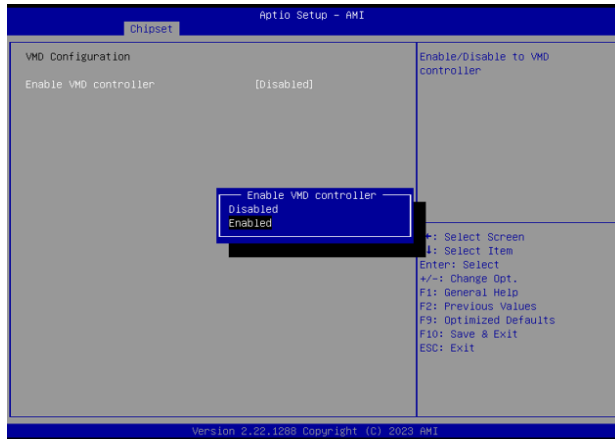

Enable VMD Controller for more options.

Save the changes and exit.

Locate Intel(R) Rapid Storage Technology option on Advanced menu.