



VP101-M8M

ARM-Based In-vehicle Fanless Touch Panel PC
User's Manual

Copyright

This publication contains information that is protected by copyright. No part of it may be reproduced in any form or by any means or used to make any transformation/adaptation without the prior written permission from the copyright holders.

This publication is provided for informational purposes only. The manufacturer makes no representations or warranties with respect to the contents or use of this manual and specifically disclaims any express or implied warranties of merchantability or fitness for any particular purpose. The user will assume the entire risk of the use or the results of the use of this document. Further, the manufacturer reserves the right to revise this publication and make changes to its contents at any time, without obligation to notify any person or entity of such revisions or changes.

Changes after the publication's first release will be based on the product's revision. The website will always provide the most updated information.

© 2024. All Rights Reserved.

Trademarks

Product names or trademarks appearing in this manual are for identification purpose only and are the properties of the respective owners.

FCC and DOC Statement on Class A

This equipment has been tested and found to comply with the limits for a Class A digital device, pursuant to Part 15 of the FCC rules. These limits are designed to provide reasonable protection against harmful interference when the equipment is operated in a residential installation. This equipment generates, uses and can radiate radio frequency energy and, if not installed and used in accordance with the instruction manual, may cause harmful interference to radio communications. However, there is no guarantee that interference will not occur in a particular installation. If this equipment does cause harmful interference to radio or television reception, which can be determined by turning the equipment off and on, the user is encouraged to try to correct the interference by one or more of the following measures:

- Reorient or relocate the receiving antenna.
- Increase the separation between the equipment and the receiver.
- Connect the equipment into an outlet on a circuit different from that to which the receiver is connected.
- Consult the dealer or an experienced radio TV technician for help.

Notice:

1. The changes or modifications not expressly approved by the party responsible for compliance could void the user's authority to operate the equipment.
2. Shielded interface cables must be used in order to comply with the emission limits.

Table of Contents

Chapter 1 - Introduction	6
Overview.....	6
Bottom View.....	6
Back View.....	6
Dimensions.....	7
Key Features.....	7
Specifications.....	8
Chapter 2 - Hardware Installations	10
Removing the Chassis Cover.....	10
Installing an M.2 Card.....	12
Mounting Options.....	13
VESA Mount.....	13
Wall Mount.....	13
Chapter 3 - System Settings	14
System Layout.....	14
Power Board.....	14
System Board.....	15
System Board - uSD Card Slot.....	16
Jumper Settings- Power Board.....	17
Host Bus Communication (JP3, JP4).....	17
Remote Switch High/Low Active (JP2).....	17
SW1.....	18
24V / 12V Select.....	18
POWER ON Delay Switch.....	18
POWER OFF Delay Switch.....	18
POWER ON Delay Time Select.....	19
POWER OFF Delay Time Select.....	19
Jumper Settings- System Board.....	20
Boot Config (JP1).....	20
LED Backlight (JP5).....	20
Pin Assignment- Power Board.....	21
12V DC-Out (CN3).....	21
9V~36V In (J1).....	21
MCU Connector (J2).....	22
MCU Debug (JP1).....	22
Remote Switch (J3).....	23
Pin Assignment- System Board.....	24
COM1 Debug (J10).....	24
USB2_3 (UBJ1).....	24
Speaker (AUJ1).....	25
Audio (AUJ2).....	25
DIO (IOJ1).....	26
I2C (J8).....	26
VP IO (VPJ1).....	27
LVDS (J11).....	28
Pin Assignment- COM Ports and CAN Bus.....	29
CAN Bus.....	29
COM1.....	29

COM2.....	29
COM3.....	29
COM4.....	29

About this Manual

This manual can be retrieved from the website.

The manual is subject to change and update without notice, and may be based on editions that do not resemble your actual products. Please visit our website or contact our sales representatives for the latest editions.

Warranty

1. Warranty does not cover damages or failures that arises from misuse of the product, inability to use the product, unauthorized replacement or alteration of components and product specifications.
2. The warranty is void if the product has been subjected to physical abuse, improper installation, modification, accidents or unauthorized repair of the product.
3. Unless otherwise instructed in this user's manual, the user may not, under any circumstances, attempt to perform service, adjustments or repairs on the product, whether in or out of warranty. It must be returned to the purchase point, factory or authorized service agency for all such work.
4. We will not be liable for any indirect, special, incidental or consequential damages to the product that has been modified or altered.

About this Package

The package contains the following items. If any of these items are missing or damaged, please contact your dealer or sales representative for assistance.

- 1 x VP101-M8M System Unit
- 1 Switch Cable
- 12 Rubber Holders
- 1 ADDM UL Battery Addendum

Note: The items are subject to change in the developing stage. The product and accessories in the package may not come similar to the information listed above. This may differ in accordance with the sales region or models in which it was sold. For more information about the standard package in your region, please contact your dealer or sales representative.

Static Electricity Precautions

It is quite easy to inadvertently damage your PC, system board, components or devices even before installing them in your system unit. Static electrical discharge can damage computer components without causing any signs of physical damage. You must take extra care in handling them to ensure against electrostatic build-up.

1. To prevent electrostatic build-up, leave the system board in its anti-static bag until you are ready to install it.
2. Wear an antistatic wrist strap.
3. Do all preparation work on a static-free surface.
4. Hold the device only by its edges. Be careful not to touch any of the components, contacts or connections.
5. Avoid touching the pins or contacts on all modules and connectors. Hold modules or connectors by their ends.



Important:

Electrostatic discharge (ESD) can damage your processor, disk drive and other components. Perform the upgrade instruction procedures described at an ESD workstation only. If such a station is not available, you can provide some ESD protection by wearing an antistatic wrist strap and attaching it to a metal part of the system chassis. If a wrist strap is unavailable, establish and maintain contact with the system chassis throughout any procedures requiring ESD protection.

Safety Precautions

- Use the correct DC / AC input voltage range.
- Unplug the power cord before removing the system chassis cover for installation or servicing. After installation or servicing, cover the system chassis before plugging in the power cord.
- There is danger of explosion if battery incorrectly replaced.
- Replace only with the same or equivalent specifications of batteries recommend by the manufacturer.
- Dispose of used batteries according to local ordinance.
- Keep this system away from humid environments.
- Make sure the system is placed or mounted correctly and stably to prevent the chance of dropping or falling may cause damage.
- The openings on the system shall not be blocked and shall be kept in distance from

other objects to make sure of proper air ventilation to protect the system from over-heating.

- Dress the cables, especially the power cord, so they will not be stepped on, in contact with high temperature surfaces, or cause any tripping hazards.
- Do not place anything on top of the power cord. Use a power cord that has been approved for use with the system and is compliant with the voltage and current ranges required by the system's electrical specifications.
- If the system is to be unused or stored for a long time, disconnect it from the power source to avoid damage by transient overvoltage.
- If one of the following occurs, consult a service personnel:
 - The power cord or plug is damaged.
 - Liquid has penetrated the system.
 - The system has been exposed to moisture.
 - The system is not working properly.
 - The system is physically damaged.
- The unit uses a three-wire ground cable which is equipped with a third pin to ground the unit and prevent electric shock. Do not defeat the purpose of this pin. If your outlet does not support this kind of plug, contact your electrician to replace the outlet.
- Disconnect the system from the electricity outlet before cleaning. Use a damp cloth for cleaning the surface. Do not use liquid or spray detergents for cleaning.
- Before connecting, make sure that the power supply voltage is correct. The device is connected to a power outlet which should be grounded connection.



The system may burn fingers while running.

Wait for 30 minutes to handle electronic parts after power off.

Chapter 1 - Introduction

► Overview

Bottom View

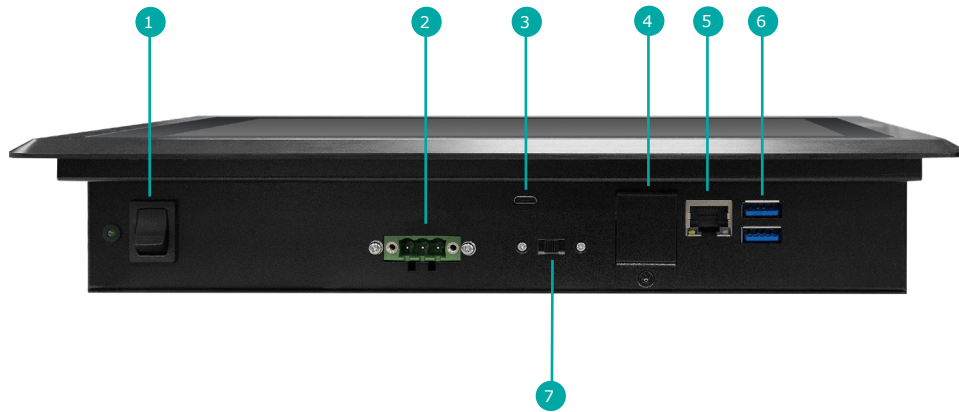

- 1 Reset Switch
- 2 Power Input
- 3 OTG
- 4 SIM
- 5 LAN
- 6 USB3.1 Gen1
- 7 Re-download Switch

Back View



- 8 COM
- 9 CAN Bus

► **Dimensions**

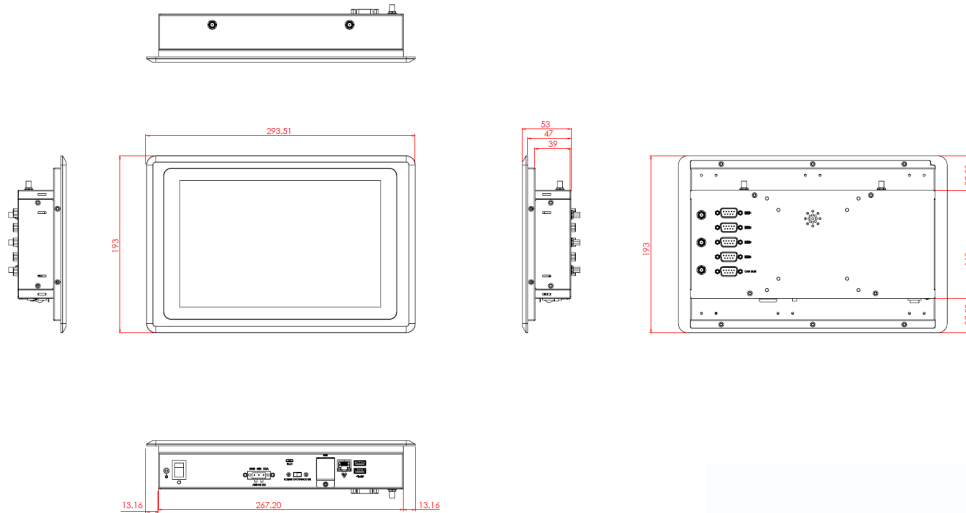

► **Key Features**

ARM-Based System:

Support Android 9.0 and Linux

IP Rating:

IP65 Front Panel Protection

Rich I/O Connectivity:

1 GbE, 4 COM, 1 CAN Bus, 2 USB 3.1 Gen1

Superior Viewing Ability

High Brightness 1200 cd/m²

Smart Power Ignition Control

Power delay and protection time setting

DFI's VP101-M8M equipped with ARM processor is the most energy-efficient All-in-One PC served as driver HMI with high brightness and high resolution TFT LCD display with capacitive touch. IP65 rated protection, wide operating temperature range, and anti-vibration ensure the system can withstand the bumpy, mountainous environment. Power management features include a wide power input range, surge protection. The built-in IMU sensor helps to record vehicle moving status. 4G, Wi-Fi, and GPS, as well as rich I/O and built-in SIM card/SD card are provided for flexible connectivity and expandability. The above function is to store or transmit the vehicle location or data to the operation center.

► Specifications

SYSTEM	Processor	NXP i.MX 8M Dual/Quad Cortex-A53
	Max. Speed	1.3GHz
MEMORY	Technology	On board Memory 2GB/4GB (Default 2GB) Single Channel LPDDR4 up to 3200 MHz
	Display Type	10.1" PCAP TFT
DISPLAY & TOUCH SCREEN	Max. Resolution	1280 x 800
	Brightness	1200 cd/m ²
		500 cd/m ²
STORAGE	Internal	Support eMMC 5.1 16GB on board (default) Support up to 64GB (optional)
EXPANSION	Interface	1 x M.2 2242/3042 B Key (USB 3.1 Gen1), Nano SIM Slot support 1 x M.2 2230 E Key (PClex1/USB2.0)
AUDIO	Audio Codec	SGTL5000
	Speaker	3W x 1
ETHERNET	Controller	AR8035
LED	Indicators	Power
Sensor	Sensor	6 axis IMU (3 Accelerometer + 3 Gyroscope)
	Ethernet	1 x Giga LAN
I/O	Serial	1 x RS-232/422/485 (COM4)
		1 x RS-232 (TX, RX, RTS, CTS) (COM2)
		2 x RS-232 (TX, RX) (COM1/COM3)
		1 x CAN Bus, DB-9
USB	2 USB3.1 Gen1	
	1 x OTG, micro USB	
Buttons	1 x Reset switch	
	1 re-download switch	
POWER	Type	9~36V DC Power input, with ACC/IGN control
OS SUPPORT	Linux	Yocto 2.5 (optional)
	Android	Android 9.0 (default)
MECHANISM	Construction	Aluminum + SGCC
	IP Rating	IP65 Front Panel Protection
	Mounting	Panel Mount /VESA Mount
	Dimensions (W x H x D)	294 x 193 x 53 mm
	Weight	1.67kg

ENVIRONMENT	Operating Temperature	-20 to 70°C
	Storage Temperature	-30 to 80°C
	Relative Humidity	10 to 90% RH (non-condensing)
Standards and Certifications	Shock	OP: Half-sine, 3G @ 11ms
		Non-OP: Half-sine, 5G @ 11ms
	Vibration	OP: Random, 1Grms @ 5~500Hz, 30min
		Non-OP: Sweep sine, 3Grms @ 10~500Hz, 30min
Certifications	CE, FCC, E-Mark R10, RoHS, UKCA (ongoing)	

Chapter 2 - Hardware Installations

► Removing the Chassis Cover

Please observe the following guidelines and follow the instructions to open the system.

1. Make sure the system and all other peripheral devices connected to it have been powered off.
2. Disconnect all power cords and cables.

Step 1:

The 8 screws of the system are used to secure the cover to the chassis. Remove the screws and put them in a safe place for later use.



Step 2:
Slide the cover to open the system.

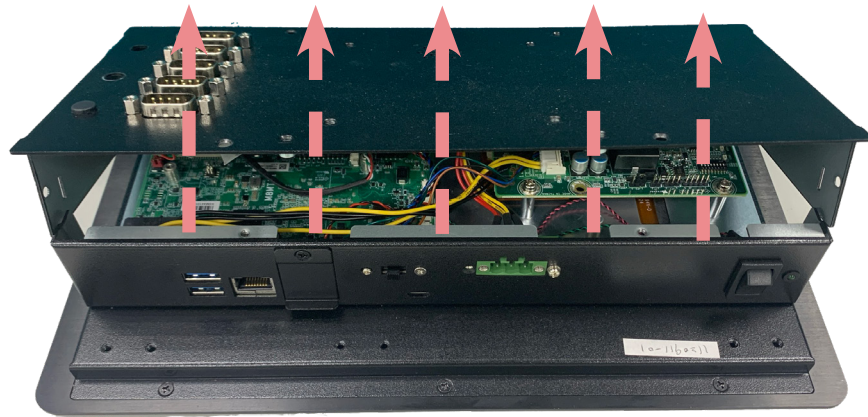

Step 3:
The boards can be easily accessed after the chassis cover is removed.

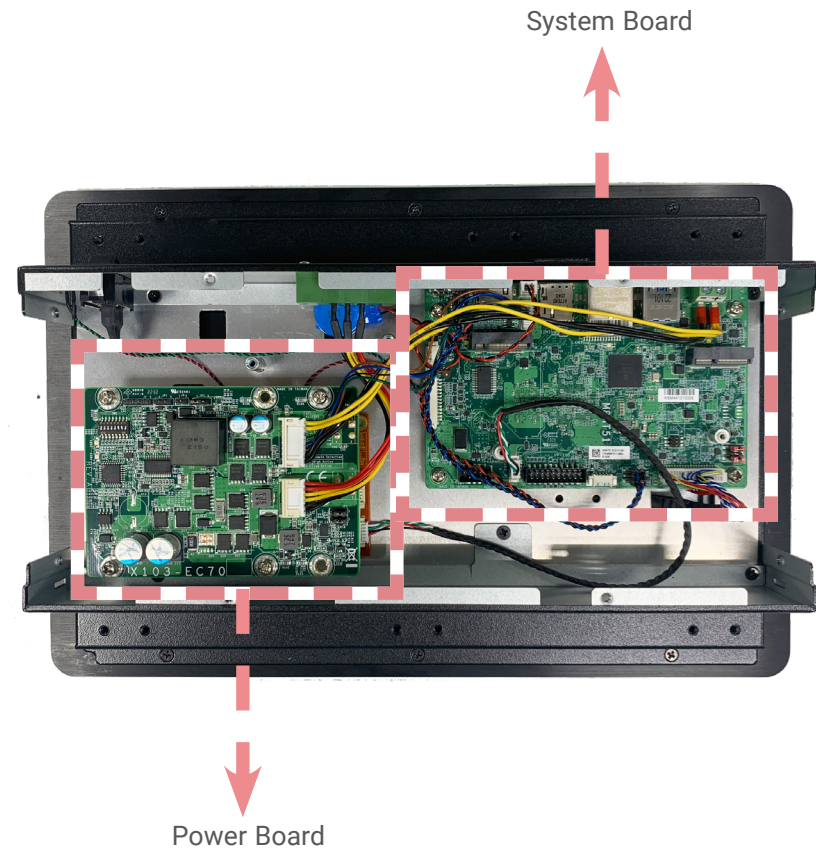

► **Installing an M.2 Card**

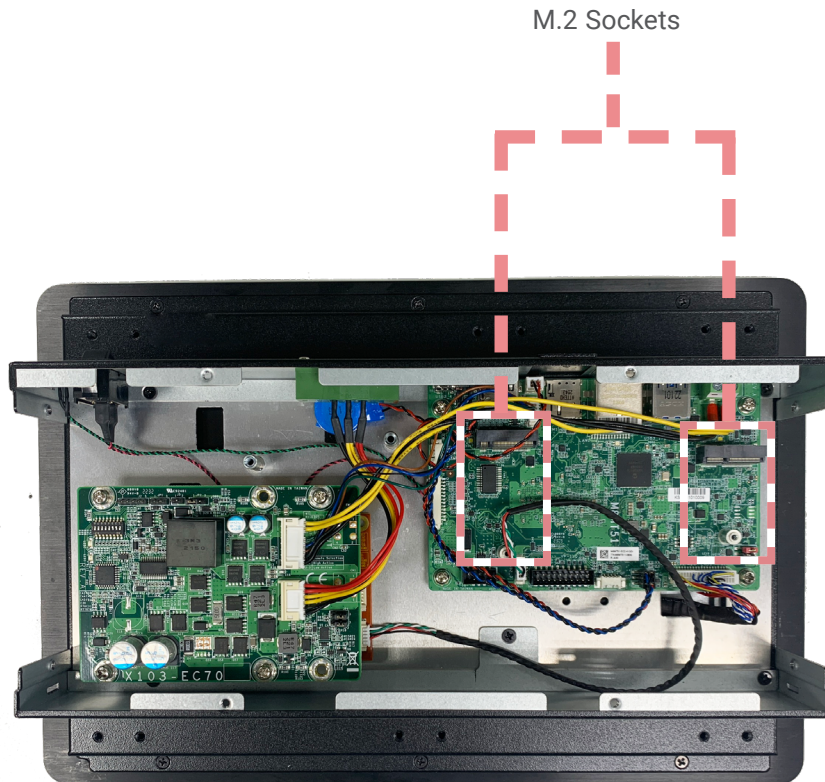

Please follow the steps below to install the card into the socket.

Step 1:

Insert the card into the socket at an angle while making sure the notch and key are perfectly aligned.

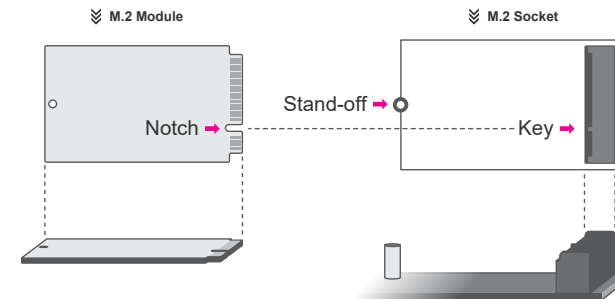

Step 2:

Press the end of the card far from the socket down until against the stand-off.

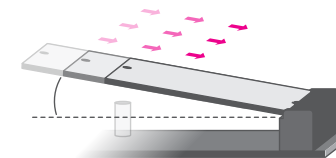

Step 3:

Screw tight the card onto the stand-off with a screw driver and a stand-off screw until the gap between the card and the stand-off closes up. The card should be lying parallel to the board when it's correctly mounted.

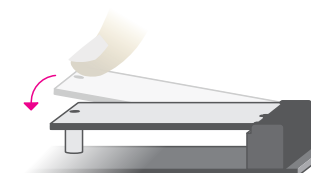

► Mounting Options

VESA Mount

Step 1:

Select a place on the wall where you will mount the Panel PC.

Step 2:

Use the provided mounting screws to attach **VESA mount bracket 1** onto the wall.

Step 3:

Attach the other bracket (**VESA mount bracket 2**) to the rear of the Panel PC.

Step 4:

Slide the Panel PC to **VESA mount bracket 1** and attach the two brackets together with the hooks. Then tighten the screw to secure the assembly in place.

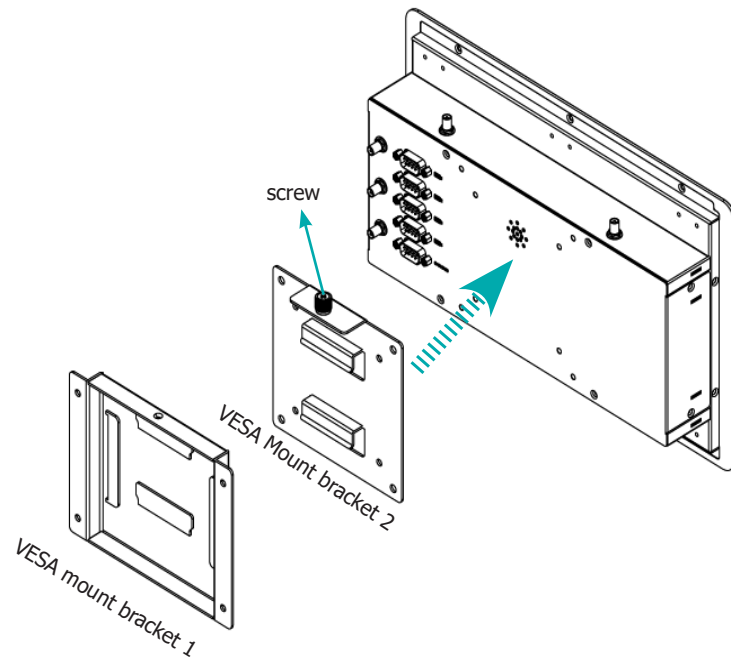

Wall Mount

Step 1:

Select a place on the wall where you will mount the Panel PC.

Step 2:

Insert the Panel PC from the outside surface of the panel into the mounting hole until it is properly fitted against the panel.

Step 3:

Attach the six brackets (**Brackets**) to the rear of the Panel PC.

Position the mounting clamps along the rear edges of the Panel PC and insert them into the slits around the Panel PC.

Step 4:

The clamps (**Clamps**) must be positioned and secured diagonally. Tighten the clamp's screw using an electric screwdriver by pressing the white plastic cap onto the back of the panel. The illustration below shows that all clamps are properly mounted.

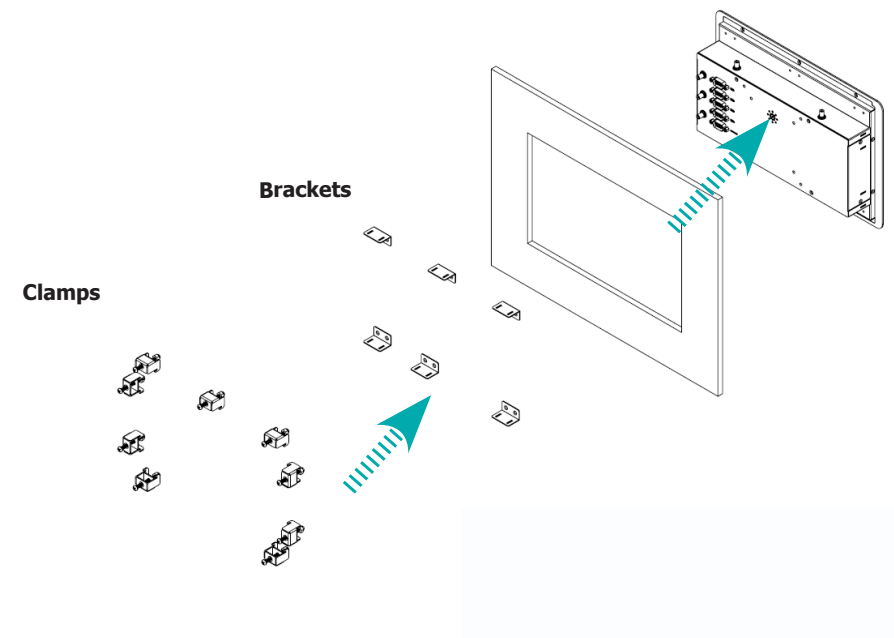

Chapter 3 - System Settings

► System Layout

Power Board

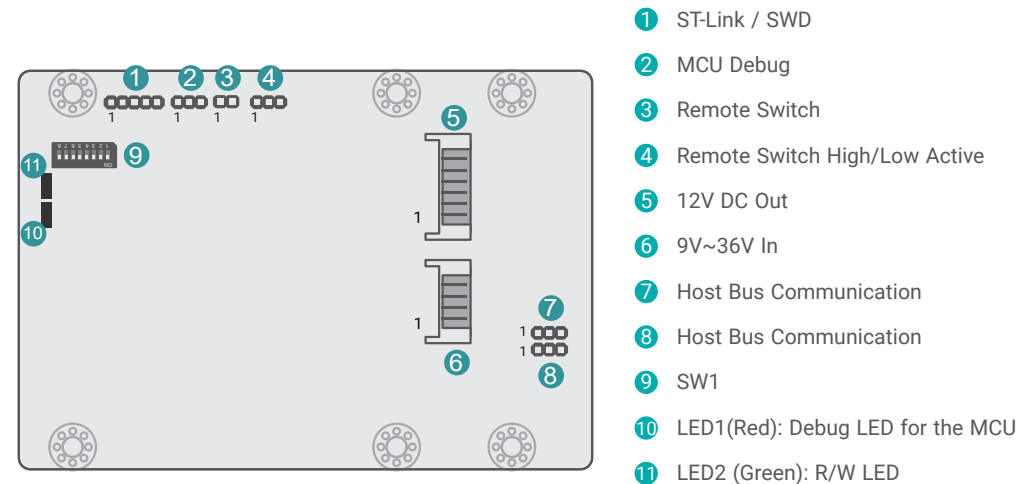
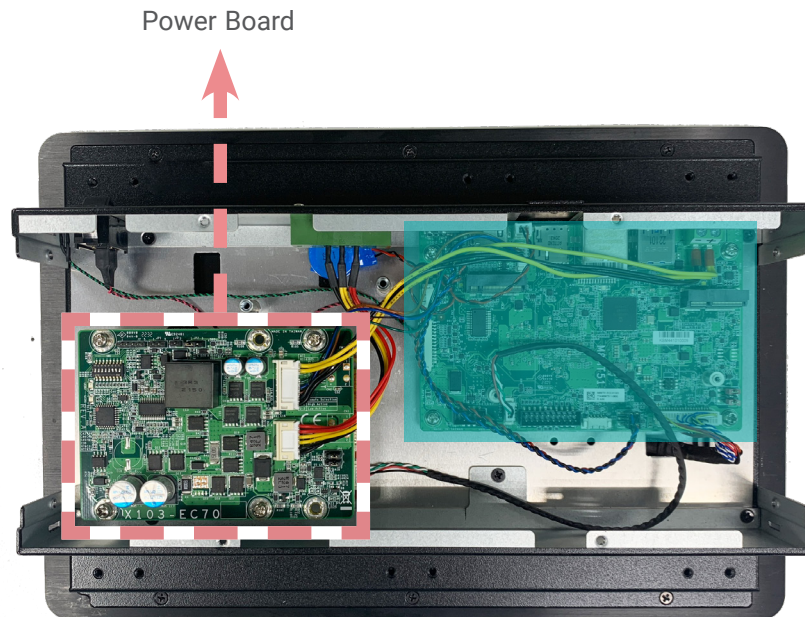

Important:

Electrostatic discharge (ESD) can damage your board, processor, disk drives, add-in boards, and other components. Perform installation procedures at an ESD workstation only. If such a station is not available, you can provide some ESD protection by wearing an antistatic wrist strap and attaching it to a metal part of the system chassis. If a wrist strap is unavailable, establish and maintain contact with the system chassis throughout any procedures requiring ESD protection.

System Board

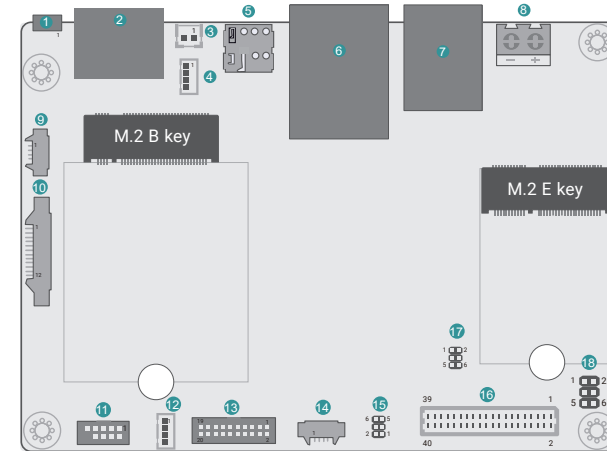
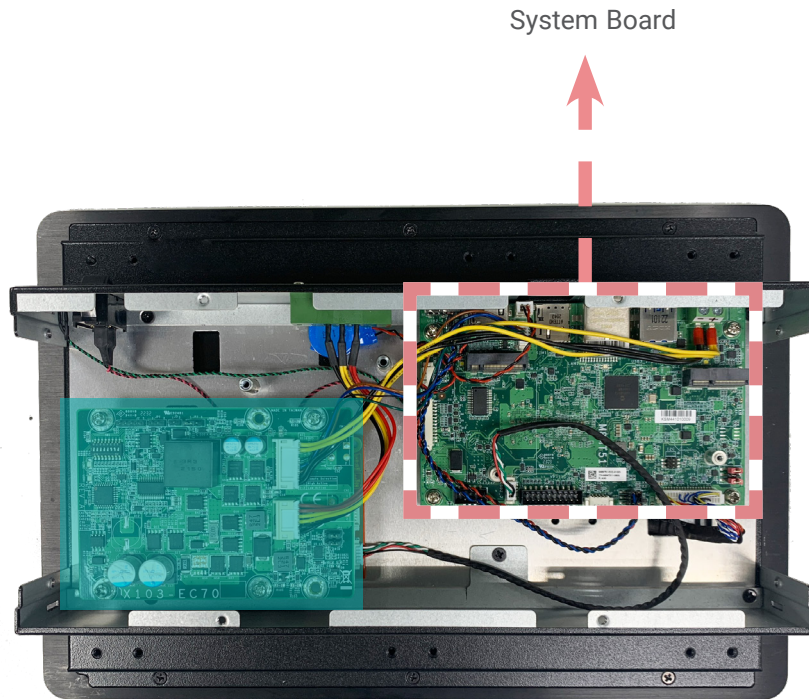

- 1 USB2_4
- 2 HDMI
- 3 Battery
- 4 Power Link
- 5 SIM Slot
- 6 LAN
- 7 USB3.0
- 8 DC-IN
- 9 Audio
- 10 DIO
- 11 Speaker
- 12 USB2_3
- 13 VP IO
- 14 COM1 Debug
- 15 Boot CFG
- 16 LVDS
- 17 I2C
- 18 LED Backlight

System Board - uSD Card Slot

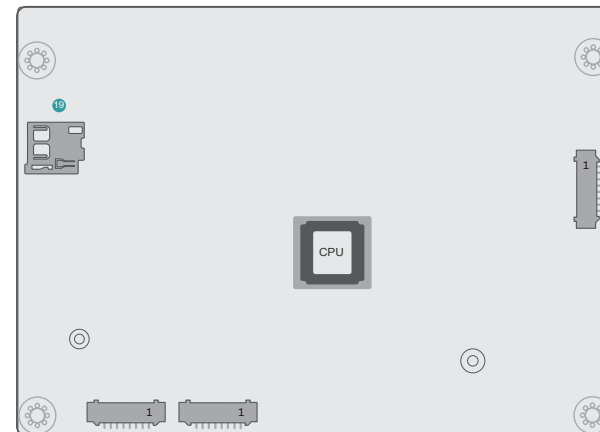
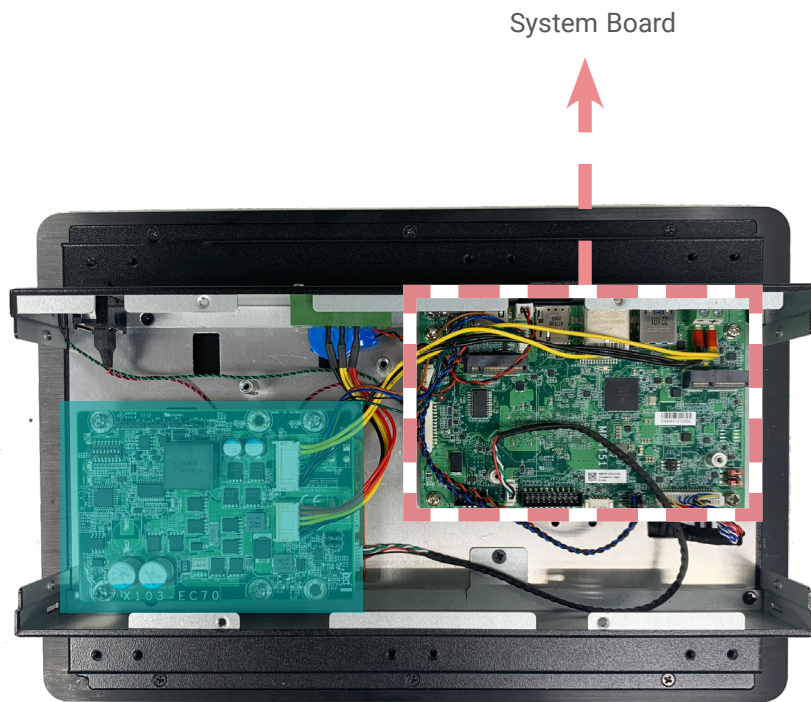

19 uSD Card Slot

► Jumper Settings- Power Board

Host Bus Communication (JP3, JP4)

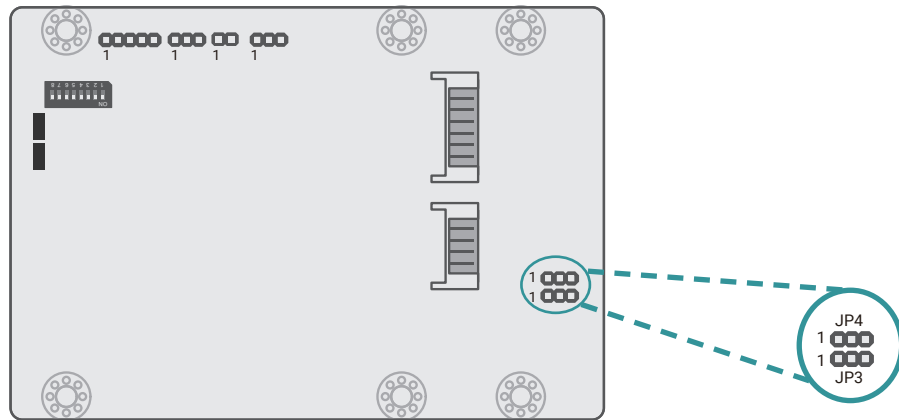

■ 1-2 On: Reserved



■ 2-3 On: TX/RX UART (default)

Remote Switch High/Low Active (JP2)

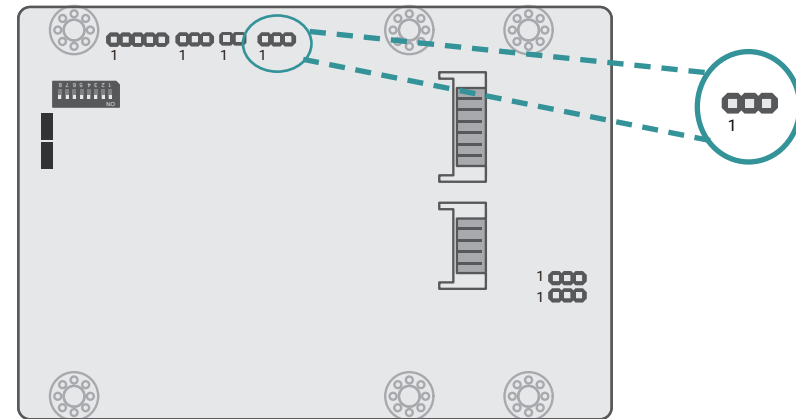

■ 1-2 On: High Active (default)



■ 2-3 On: Low Active

SW1

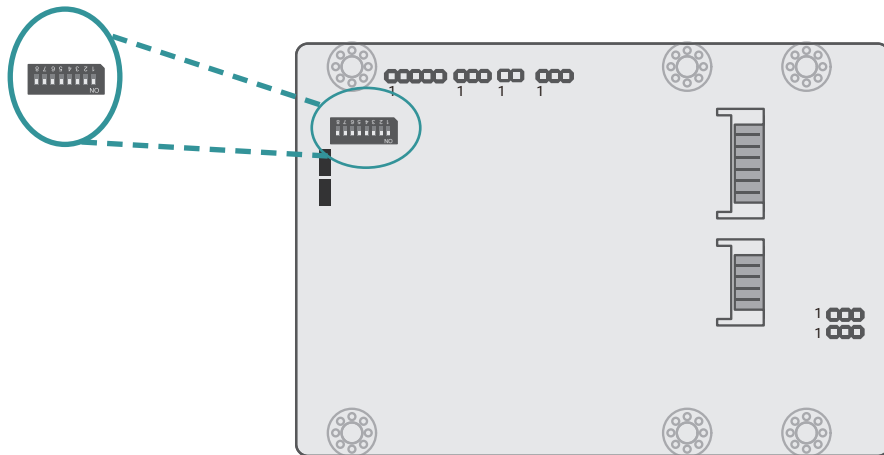

24V / 12V Select

1 Output Voltage

On 12V (default)

Off 24V

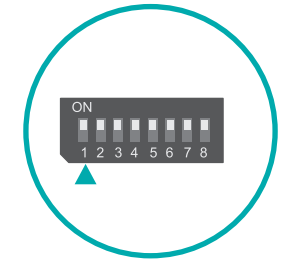

POWER ON Delay Switch

2 Delay On/Off

On On, delay duration defined by 4 and 5

Off Off, delay = 3 seconds by default

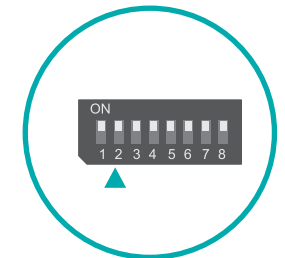

POWER OFF Delay Switch

3 Delay On/Off

On On, delay duration defined by 6, 7, and 8

Off Off, delay = 0 second by default

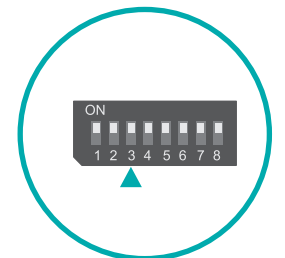

Important:
Power-off the system and then unplug the power cord prior to setting the switches. Failure to do so will cause severe damage to the system and components.

POWER ON Delay Time Select

5	4	Delay Duration	
On	On	10 seconds (default)	
On	Off	30 seconds	
Off	On	1 minute	
Off	Off	5 minutes	

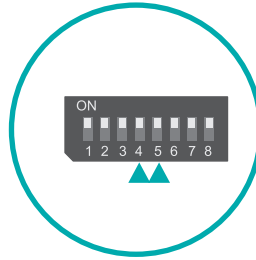

POWER OFF Delay Time Select

8	7	6	Delay Duration
On	On	On	30 seconds (default)
On	On	Off	1 minute
On	Off	On	3 minutes
On	Off	Off	5 minutes
Off	On	On	10 minutes
Off	On	Off	15 minutes
Off	Off	On	30 minutes
Off	Off	Off	1 hour

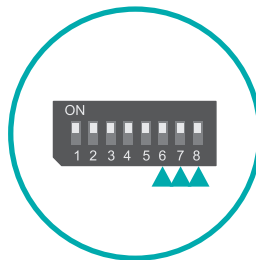

► Jumper Settings- System Board

Boot Config (JP1)

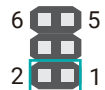
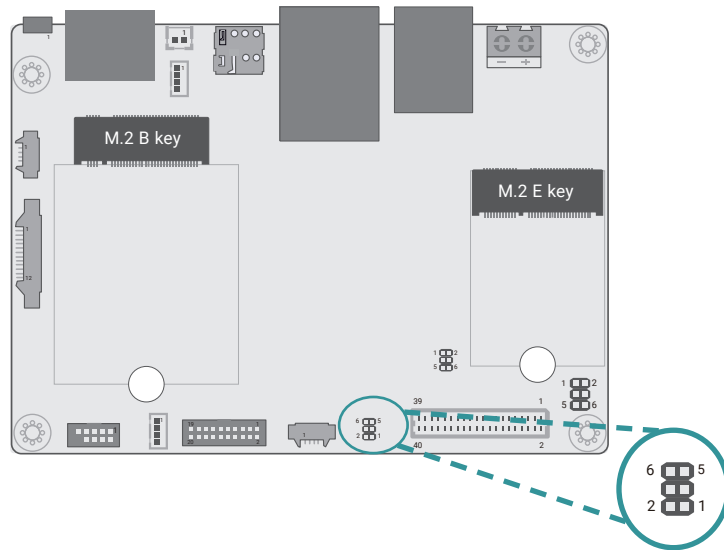

- 1-2 Off: Internal Boot (default)
- 1-2 On: Serial Downloader

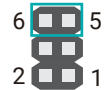

- 5-6 Off: EMMC@eSDHC3 (default)
- 5-6 On: uSD@eSDHC2

LED Backlight (JP5)

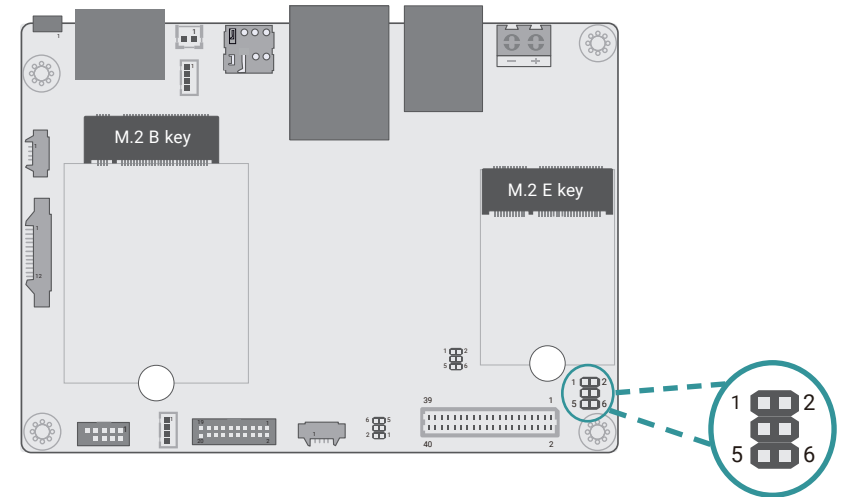

For VEN & VPWM

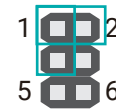

- 1-2 On: 3.3V (Default)
- 1-3 On: 5V

For VLED Backlight

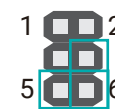

- 5-6 On: Backlight Power 12V (default)
- 4-6 On: Backlight Power 5V

► Pin Assignment- Power Board

12V DC-Out (CN3)

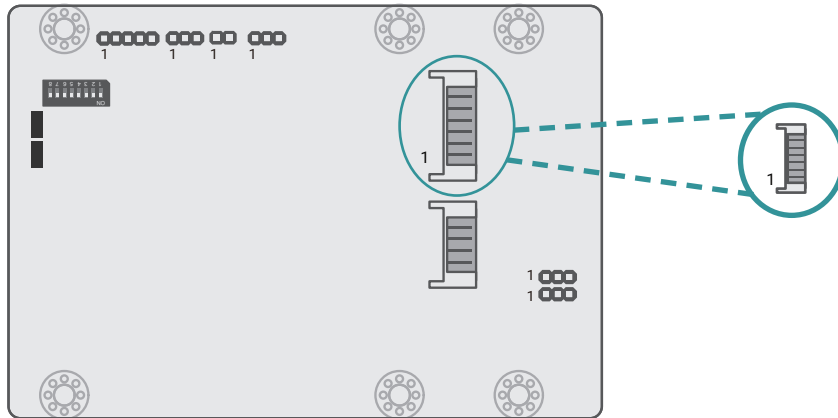

Pin	Assignment
1	GND
2	GND
3	Power Button
4	Host TX
5	Host RX
6	12VSB
7	12VSB
8	12VSB

9V~36V In (J1)

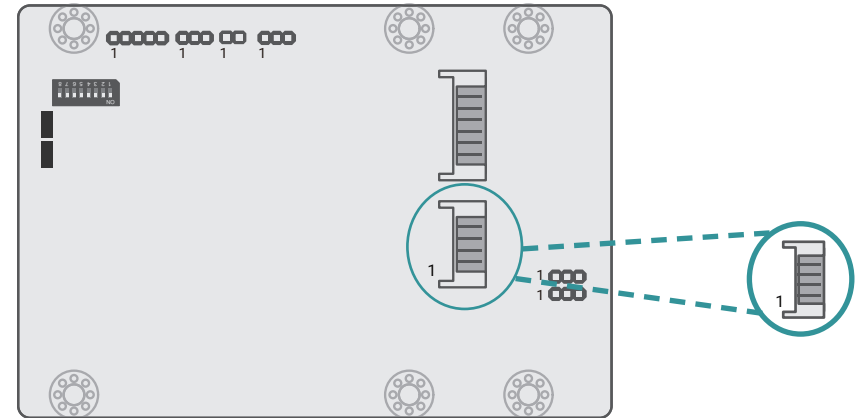

Pin	Assignment
1	V_In
2	V_In
3	Ignition
4	Ignition
5	GND
6	GND

The 9V~36V In box headers are for ignition and power input to the power board, which then converts to 12VDC for output to the system board.

Jumper Settings

Power on/off, delay time, and other power related aspects can be configured via SW1 as previously instructed in this chapter.

MCU Connector (J2)

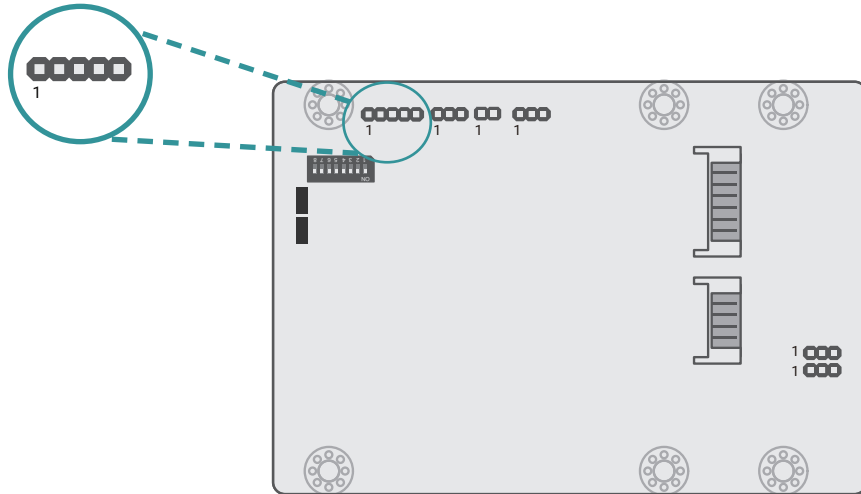

Pin	Assignment
1	3V
2	GND
3	SYS_SWDIO
4	SYS_SWCLK
5	STMCU_RST#

MCU Debug (JP1)

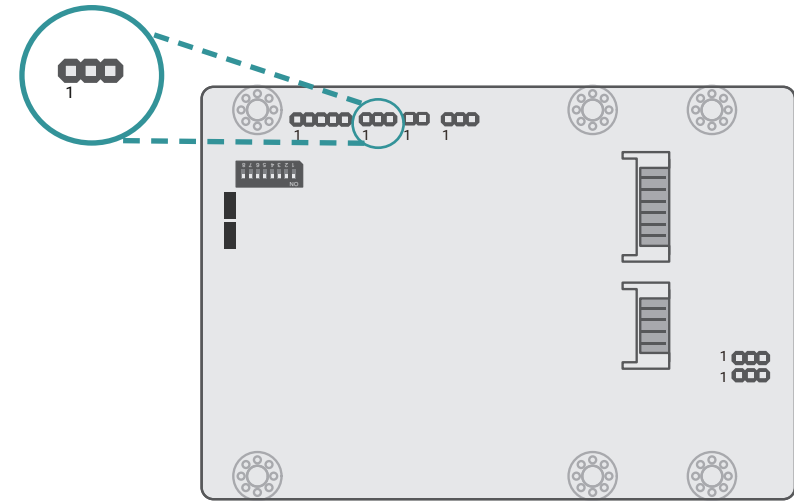

Pin	Assignment
1	UART_TX
2	UART_RX
3	GND

Remote Switch (J3)

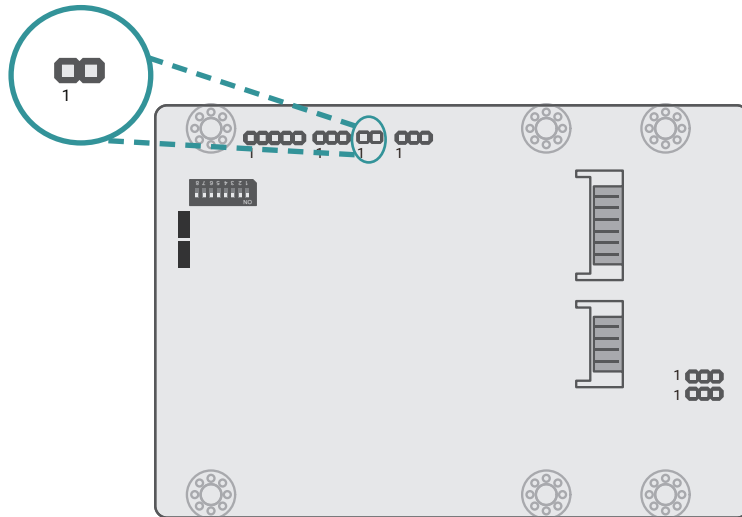

Pin	Assignment
1	Power Button
2	GND

► Pin Assignment- System Board

COM1 Debug (J10)

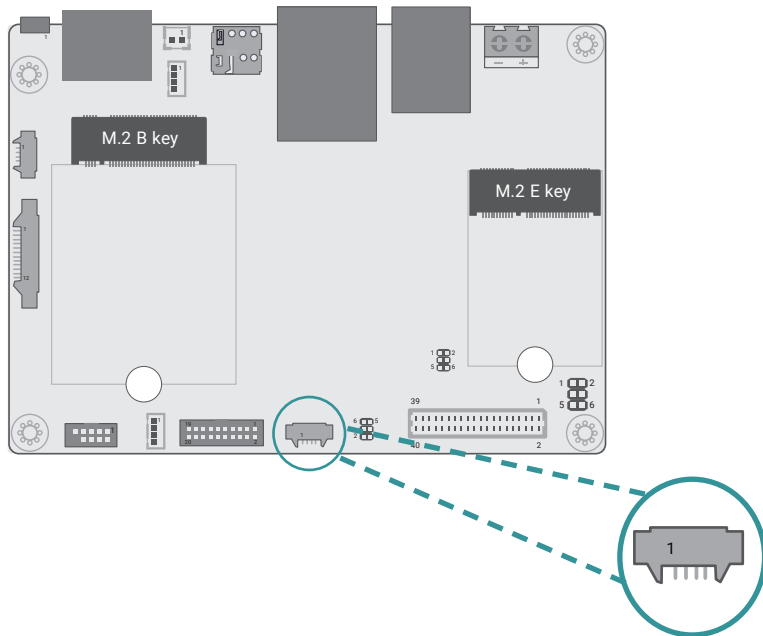

Pin	Assignment
1	+3.3V
2	UART1_RX
3	UART1_TX
4	GND

USB2_3 (UBJ1)

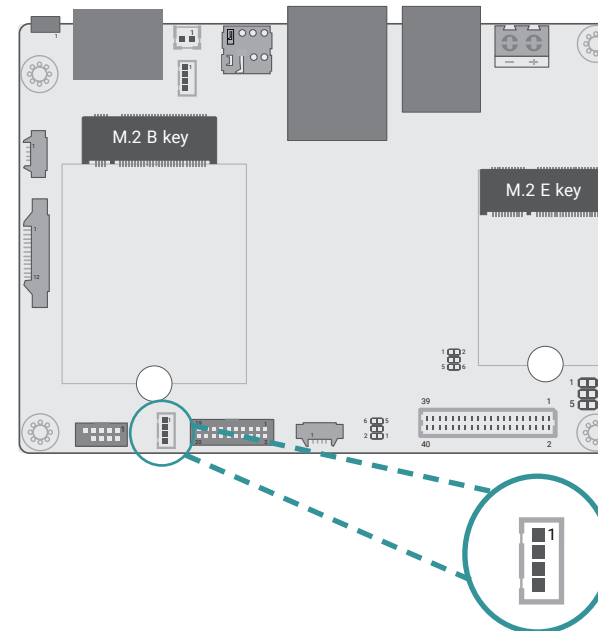

Pin	Assignment
1	+5V
2	USBDN
3	USBDP
4	GND

Speaker (AUJ1)

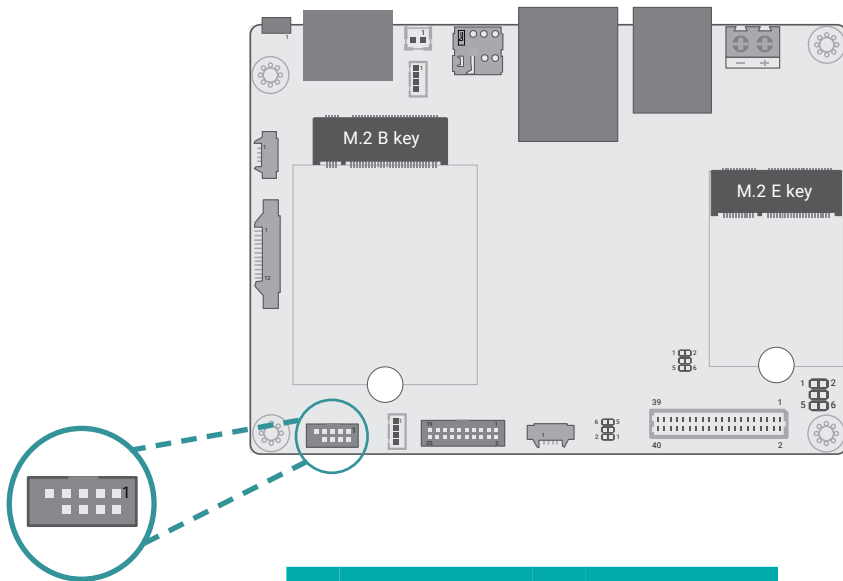

Pin	Assignment	Pin	Assignment
1	NC	2	SPK_R-
3	NC	4	SPK_R+
5	NC	6	SPK_L+
7	NC	8	SPK_L-
9	NC		

Audio (AUJ2)

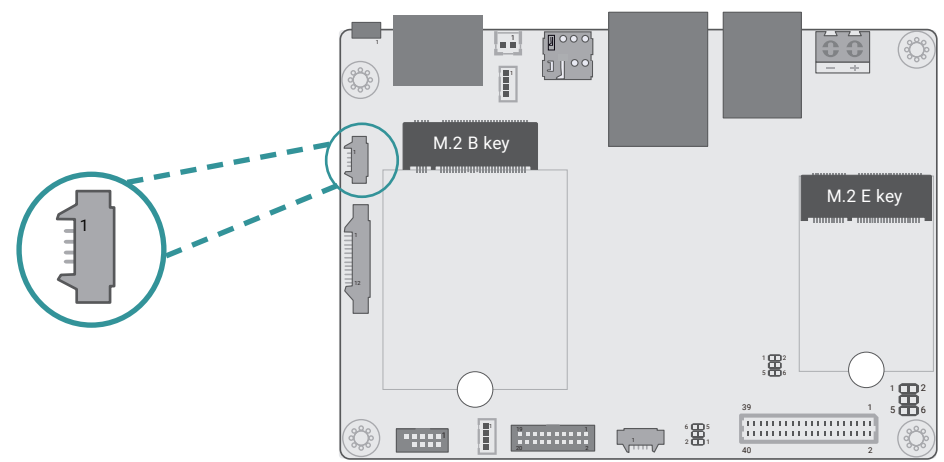

Pin	Assignment
1	LOUT_L
2	LOUT_R
3	AGND
4	MIC_IN

DIO (IOJ1)

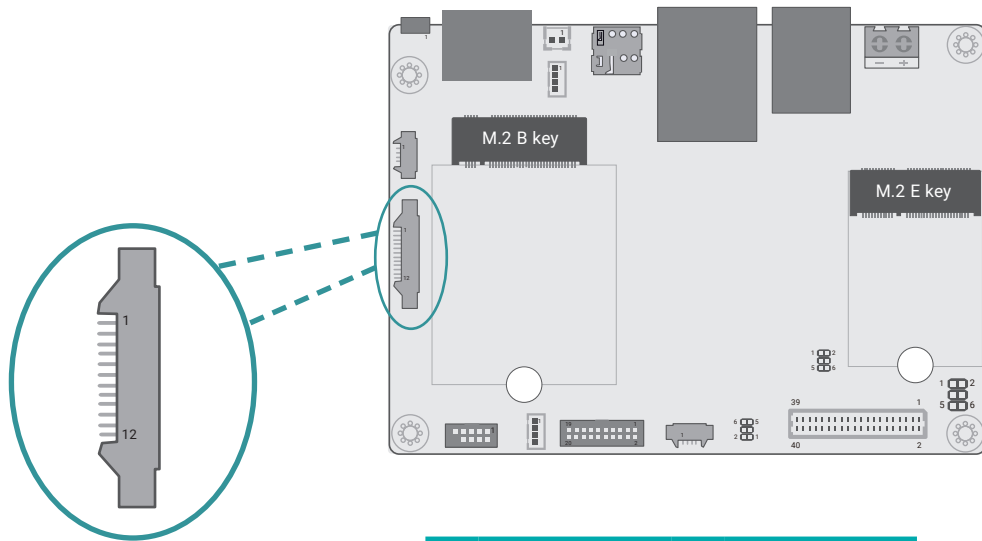

Pin	Assignment	Pin	Assignment
1	DIO0	2	DIO1
3	DIO2	4	DIO3
5	DIO4	6	DIO5
7	DIO6	8	DIO7
9	+5V	10	PWM
11	GND	12	GND

I2C (J8)

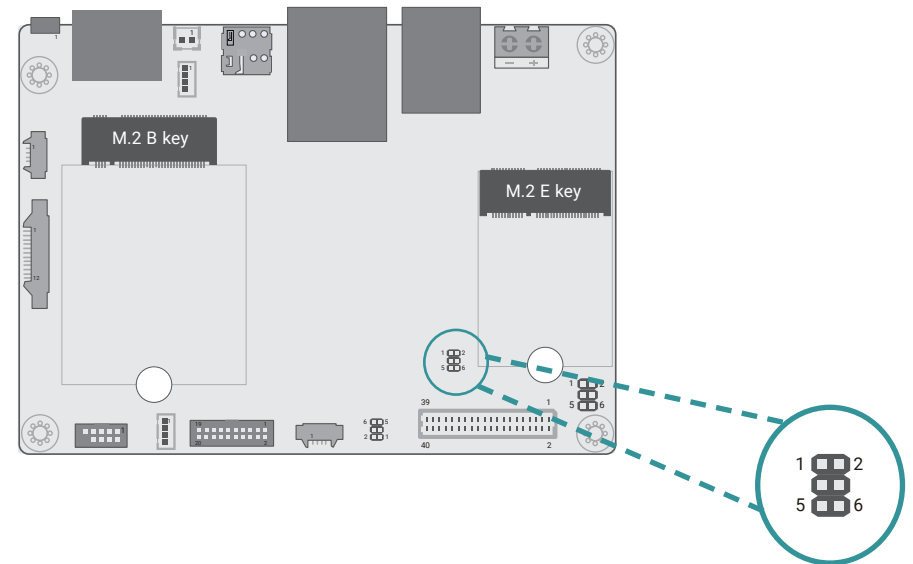

Pin	Assignment	Pin	Assignment
1	+3.3V_TP	2	GND
3	TP_SCL	4	TP_ALT#
5	TP_SDA	6	TP_RST#

VP IO (VPJ1)

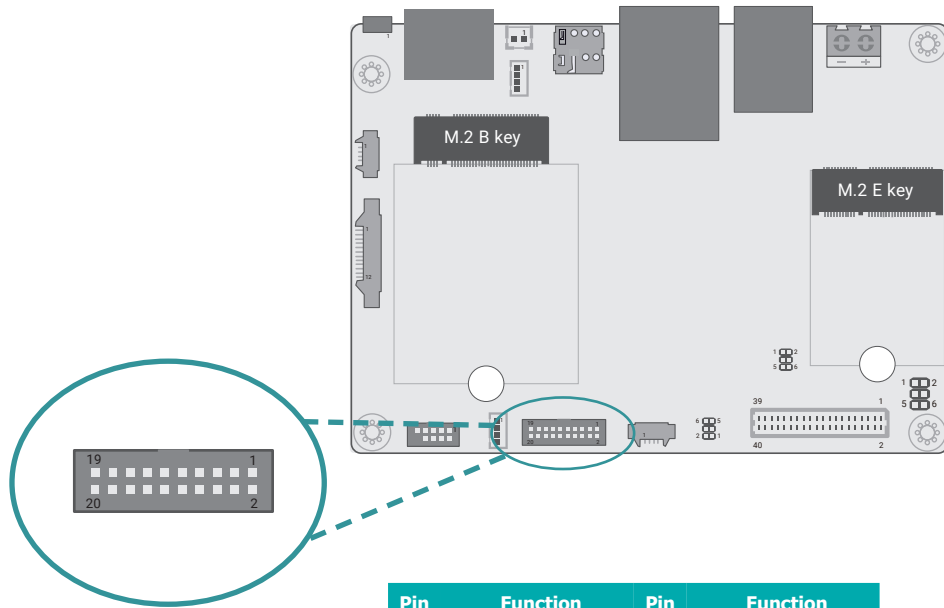

Pin	Function	Pin	Function
1	+5V	2	CAN_GND
3	SOUTN3	4	CAN_H
5	LVDS_A2+	6	CAN_L
7	SINN3	8	UR1_TX_232
9	SINN4	10	UR1_RX_232
11	SOUTN4	12	RTSN2
13	DTRN4	14	CTSN2
15	RTSN4	16	SOUTN2
17	CTSN4	18	SINN2
19	GND	20	GND

LVDS (J11)

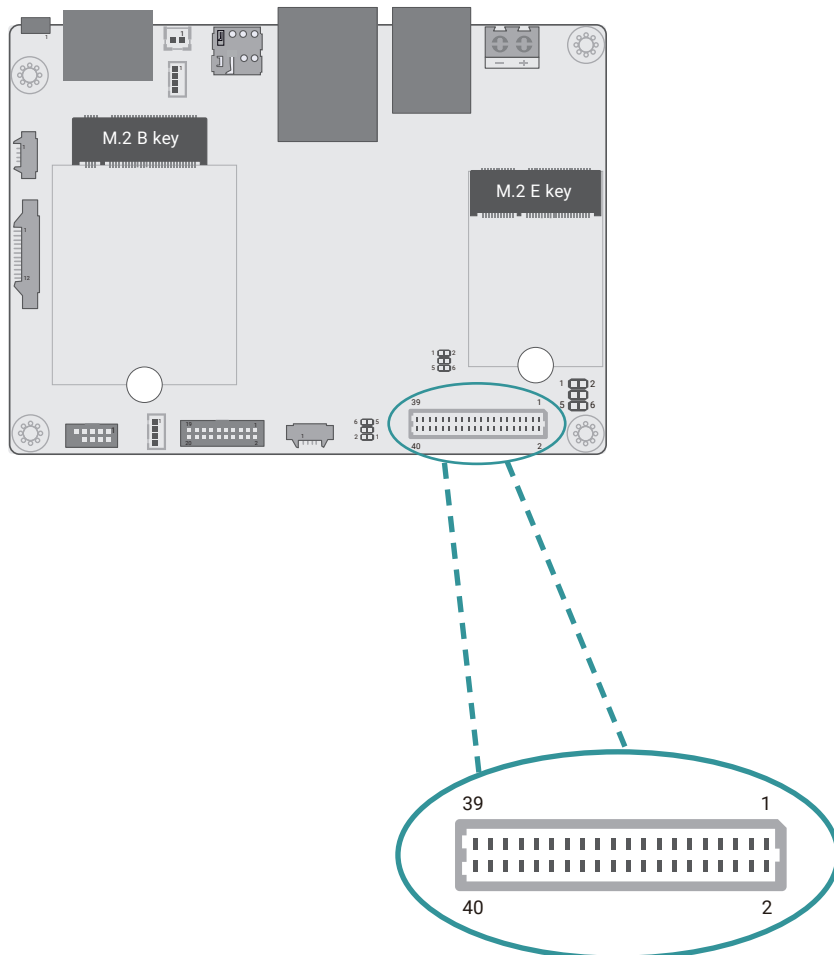

Pin	Function	Pin	Function
1	GND	2	GND
3	LVDS_A2-	4	LVDS_B3+
5	LVDS_A2+	6	LVDS_B3-
7	GND	8	GND
9	LVDS_A3-	10	LVDS_B2+
11	LVDS_A3+	12	LVDS_B2-
13	GND	14	GND
15	LVDS_A0-	16	LVDS_B1+
17	LVDS_A0+	18	LVDS_B1-
19	GND	20	GND
21	LVDS_A1-	22	LVDS_B0+
23	LVDS_A1+	24	LVDS_B0-
25	GND	26	GND
27	LVDS_A_CLK-	28	LVDS_B_CLK-
29	LVDS_A_CLK+	30	LVDS_B_CLK+
31	GND	32	GND
33	GND	34	GND
35	+VDD_3.3V	36	+VDD_5V
37	+VDD_3.3V	38	+VDD_5V
39	+VDD_3.3V	40	+VDD_5V

► Pin Assignment- COM Ports and CAN Bus



CAN Bus

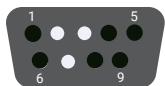

Pin	Function	Pin	Function
1	NC	2	CAN_L
3	CAN_GND	4	NC
5	NC	6	NC
7	CAN_H	8	NC
9	NC		

COM1

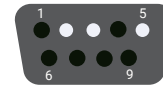

Pin	Function	Pin	Function
1	NC	2	RX
3	TX	4	NC
5	GND	6	NC
7	NC	8	NC
9	NC		

COM2

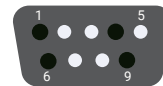

Pin	Function	Pin	Function
1	NC	2	SINN2 (RX)
3	SOUTN2 (TX)	4	NC
5	GND	6	NC
7	RTSN2	8	CTSN2
9	NC		

COM3

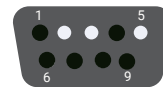

Pin	Function	Pin	Function
1	NC	2	SINN3 (RX)
3	SOUTN3 (TX)	4	NC
5	GND	6	NC
7	NC	8	NC
9	NC		

COM4

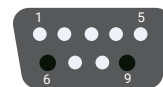

Pin	Function	Pin	Function
1	DCDN4	2	SINN4 (RX)
3	SOUTN4 (TX)	4	DTRN4
5	GND	6	NC
7	RTSN4	8	CTSN4
9	NC		