



CS620-H310

ATX Industrial Motherboard
User's Manual

Copyright

This publication contains information that is protected by copyright. No part of it may be reproduced in any form or by any means or used to make any transformation/adaptation without the prior written permission from the copyright holders.

This publication is provided for informational purposes only. The manufacturer makes no representations or warranties with respect to the contents or use of this manual and specifically disclaims any express or implied warranties of merchantability or fitness for any particular purpose. The user will assume the entire risk of the use or the results of the use of this document. Further, the manufacturer reserves the right to revise this publication and make changes to its contents at any time, without obligation to notify any person or entity of such revisions or changes.

Changes after the publication's first release will be based on the product's revision. The website will always provide the most updated information.

© 2020. All Rights Reserved.

Trademarks

Product names or trademarks appearing in this manual are for identification purpose only and are the properties of the respective owners.

FCC and DOC Statement on Class B

This equipment has been tested and found to comply with the limits for a Class B digital device, pursuant to Part 15 of the FCC rules. These limits are designed to provide reasonable protection against harmful interference when the equipment is operated in a residential installation. This equipment generates, uses and can radiate radio frequency energy and, if not installed and used in accordance with the instruction manual, may cause harmful interference to radio communications. However, there is no guarantee that interference will not occur in a particular installation. If this equipment does cause harmful interference to radio or television reception, which can be determined by turning the equipment off and on, the user is encouraged to try to correct the interference by one or more of the following measures:

- Reorient or relocate the receiving antenna.
- Increase the separation between the equipment and the receiver.
- Connect the equipment into an outlet on a circuit different from that to which the receiver is connected.
- Consult the dealer or an experienced radio TV technician for help.

Notice:

1. The changes or modifications not expressly approved by the party responsible for compliance could void the user's authority to operate the equipment.
2. Shielded interface cables must be used in order to comply with the emission limits.

Table of Contents

Chapter 1 - Introduction	6
Specifications	6
CS620-H310	6
Features	7
Chapter 2 - Hardware Installation	8
Board Layout.....	8
Standby Power LED.....	8
System Memory	9
Installing the DIMM Module	9
Removing the DIMM Module.....	10
CPU.....	11
Installing the CPU	11
Installing the Fan and Heat Sink	13
Jumper Settings	14
Clear CMOS.....	14
COM 1 Serial Mode	14
COM 2 Serial Mode	15
COM 1/2 RS232 Power Select	15
SATA port0 / mSATA Switch	16
Digital I/O (DIO) Power Supply	16
Digital I/O (DIO) Power Select	17
Rear I/O Ports.....	18
PS/2 Keyboard/Mouse.....	18
USB Ports.....	19
Graphics Display.....	19
RJ45 LAN	20
Audio.....	20
COM 1 (Serial) Port	21
Internal I/O Connectors	21
COM (Serial) Ports	21
USB Ports.....	22
Front Audio.....	23
SATA (Serial ATA)	23
Digital I/O	24
Cooling Fan Connectors.....	24
Power Connector	25
Chassis Intrusion.....	25
Front Panel.....	26
S/PDIF.....	26
Battery	27
SMBus	27
LPC	28
External COM port Module	28
LAN LED	29
Expansion Slots	29
Installing the Mini PCIe Module	30
Chapter 3 - BIOS Settings	31
Overview	31
Main.....	32
Advanced	32

RC ACPI Configuration	33
CPU Configuration.....	33
Power & Performance	34
PCH-FW Configuration	34
Trusted Computing.....	36
NCT6116D Super IO Configuration	36
NCT6116D HW Monitor	37
Serial Port Console Redirection	38
USB Configuration	39
CSM Configuration	40
USB Power Control.....	40
Network Stack Configuration.....	41
Chipset	42
Graphics Configuration	42
PEG Port Configuration	43
PCH-IO Configuration	44
PCI Express Configuration.....	44
SATA And RST Configuration.....	45
HD Audio Configuration	45
Security	46
Secure Boot.....	46
Boot	47
Save & Exit	47
Updating the BIOS	48
Notice: BIOS SPI ROM.....	48

About this Manual

This manual can be downloaded from the website.

Please visit our website or contact our sales representatives for the latest editions.

Warranty

1. Warranty does not cover damages or failures that occur from misuse of the product, inability to use the product, unauthorized replacement or alteration of components and product specifications.
2. The warranty is void if the product has been subjected to physical abuse, improper installation, modification, accidents or unauthorized repair of the product.
3. Unless otherwise instructed in this user's manual, the user may not, under any circumstances, attempt to perform service, adjustments or repairs on the product, whether in or out of warranty. It must be returned to the purchase point, factory or authorized service agency for all such work.
4. We will not be liable for any indirect, special, incidental or consequential damages to the product that has been modified or altered.

Static Electricity Precautions

It is quite easy to inadvertently damage your PC, system board, components or devices even before installing them in your system unit. Static electrical discharge can damage computer components without causing any signs of physical damage. You must take extra care in handling them to ensure against electrostatic build-up.

1. To prevent electrostatic build-up, leave the system board in its anti-static bag until you are ready to install it.
2. Wear an antistatic wrist strap.
3. Do all preparation work on a static-free surface.
4. Hold the device only by its edges. Be careful not to touch any of the components, contacts or connections.
5. Avoid touching the pins or contacts on all modules and connectors. Hold modules or connectors by their ends.



Important:

Electrostatic discharge (ESD) can damage your processor, disk drive and other components. Perform the upgrade instruction procedures described at an ESD workstation only. If such a station is not available, you can provide some ESD protection by wearing an antistatic wrist strap and attaching it to a metal part of the system chassis. If a wrist strap is unavailable, establish and maintain contact with the system chassis throughout any procedures requiring ESD protection.

Safety Measures

- To avoid damage to the system, use the correct AC input voltage range.
- To reduce the risk of electric shock, unplug the power cord before removing the system chassis cover for installation or servicing. After installation or servicing, cover the system chassis before plugging the power cord.

About the Package

The package contains the following items. If any of these items are missing or damaged, please contact your dealer or sales representative for assistance.

- 1 CS620-H310 motherboard
- 1 COM port cables (W/Bracket, Length: 300mm, 2 x COM ports): A81-015026-023G
- 1 Serial ATA data cable (Length: 500mm): 332-553001-005G
- 1 I/O shield: A49-KD6000-000G
- 1 mSATA screw: A32-112016-041G

The board and accessories in the package may not come similar to the information listed above. This may differ in accordance with the sales region or models in which it was sold. For more information about the standard package in your region, please contact your dealer or sales representative.

Optional Items

- USB 2.0 port cable A81-001066-016G Length: 350mm
- D-SUB cable A81-015026-023G W/Bracket, Length: 300mm, 2 x COM ports
- Serial ATA data cable 332-553001-005G W/Lock, Length: 500mm
- Thermal solution A71-101107-000G
- A71-101107-000G
- 552-200049-000G
- 761-103001-000G For 35W, Height: 37.3mm
- For 35W, Height: 37.3mm
- For 65W, Height: 72.8mm
- For 95W, Height: 69.3mm
- DP to HDMI dongle 612-D2H13M-000G
- LPC EXT-RS232 module 770-EXTRS1-000G 4 x RS232 ports
- LPC EXT-RS485 module 770-EXTRS1-100G 4 x RS485 ports

The board and accessories in the package may not come similar to the information listed

above. This may differ in accordance with the sales region or models in which it was sold. For more information about the standard package in your region, please contact your dealer or sales representative.

Before Using the System Board

When installing the system board in a new system, you will need at least the following internal components.

- CPU
- Memory module
- Storage device such as hard disk drive, CD-ROM, etc.
- Power adaptor

External system peripherals may also be required for navigation and display, including at least a keyboard, a mouse and a video display monitor.

Chapter 1 - Introduction

► Specifications

CS620-H310

SYSTEM Processor

8th Generation Intel® LGA 1151 Socket Processors, TDP support up to 95W (suffix with "K" is non-LTS)

Intel® Core™ i7-8700 (6 Cores, 12M Cache, up to 4.6 GHz); 65W

Intel® Core™ i7-8700T (6 Cores, 12M Cache, up to 4.0 GHz); 35W

Intel® Core™ i5-8500 (6 Cores, 9M Cache, up to 4.1 GHz); 65W

Intel® Core™ i5-8500T (6 Cores, 9M Cache, up to 3.5 GHz); 35W

Intel® Core™ i3-8100 (4 Cores, 6M Cache, 3.6 GHz); 65W

Intel® Core™ i3-8100T (4 Cores, 6M Cache, to 3.1 GHz); 35W

Intel® Pentium® G5400 (2 Cores, 4M Cache, 3.7 GHz); 58W

Intel® Pentium® G5400T (2 Cores, 4M Cache, 3.1 GHz); 35W

Intel® Celeron® G4900 (2 Cores, 2M Cache, 3.1 GHz); 54W

Intel® Celeron® G4900T (2 Cores, 2M Cache, 2.9 GHz); 35W

9th Generation Intel® LGA 1151 Socket Processors, TDP support up to 95W:

Intel® Core™ i7-9700E (8 Cores, 12M Cache, up to 3.8 GHz); 65W

Intel® Core™ i7-9700TE (8 Cores, 12M Cache, up to 3.8 GHz); 65W

Intel® Core™ i5-9500E (6 Cores, 9M Cache, up to 4.2 GHz); 65W

Intel® Core™ i5-9500TE (6 Cores, 9M Cache, up to 4.2 GHz); 65W

Intel® Core™ i3-9100E (4 Cores, 6M Cache, to 3.2 GHz); 65W

Intel® Core™ i3-9100TE (4 Cores, 6M Cache, to 3.2 GHz); 65W

Chipset Intel® H310 Chipset

Memory Two 288-pin UDIMM up to 64GB (non-ECC support)
Dual Channel DDR4 2400/2666MHz

BIOS AMI SPI 128Mbit

GRAPHICS

Controller Intel® HD Gen 9 Graphics

Feature OpenGL 5.0, DirectX 12, OpenCL 2.1

HW Decode: AVC/H.264, MPEG2, VC1/WMV9, JPEG/MJPEG, HEVC/H265, VP8, VP9

HW Encode: MPEG2, AVC/H264, JPEG, HEVC/H265, VP8, VP9

Display 1 x VGA resolution up to 1920x1200 @ 60Hz

1 x DVI-D resolution up to 1920x1200 @ 60Hz

1 x DP++ resolution up to 4096x2160 @ 60Hz

Multiple Displays VGA + DVI-D / VGA + DP++ / DP++ + DVI-D

EXPANSION **Interface** 1 x PCIe x16 (Gen 3)
1 x PCIe x4 Gen2 (PCIe x1 signal)
4 x PCI
2 x ISA

AUDIO **Audio Codec** Realtek ALC887

ETHERNET **Controller** 1 x Intel® I210AT PCIe (10/100/1000Mbps) 1
x Intel® I219V Lan Phy (10/100/1000Mbps)

REAR I/O **Ethernet** 2 x GbE (RJ-45)

Serial 1 x RS-232/422/485 (RS-232 w/ power) (DB-9)

USB 4 x USB 3.1 (Gen1)

2 x USB 2.0

PS/2 1 x PS/2 (mini-DIN-6)

Display 1 x VGA / 1 x DVI-I (DVI-D signal) / 1 x DP++

Audio 1 x Mic-in, 1 x Line-out (colay Line-in as opt., MOQ required)

INTERNAL I/O **Serial** 1 x RS-232/422/485 (RS-232 w/ power) (2.54mm pitch)

4 x RS-232 (2.54mm pitch)

USB 4 x USB 2.0 (2.54mm pitch) (one header colay USB 3.0 vertical Type A as opt., MOQ required)

Display 1 x Parallel

Audio 1 x Front Audio Header / 1 x S/PDIF

SATA 4 x SATA 3.0 (up to 6Gb/s)

1 x mSATA shared with SATA (opt: PCIe x1 signal, MOQ required)

DIO 1 x 8-bit DIO

LPC 1 x LPC

SMBus 1 x SMBus

WATCHDOG TIMER **Output & Interval** System Reset, Programmable via Software from 1 to 255 Seconds

SECURITY **TPM** TPM2.0 (opt., MOQ required)

POWER **Type** ATX

Connector 8-pin ATX 12V power

24-pin ATX power

Power TBD

Consumption

RTC Battery CR2032 Coin Cell

OS SUPPORT Windows 10 IoT Enterprise 64-bit (Without ISA support.)

DFI SW package (With ISA support. Please contact DFI if need more information.)

ENVIRONMENT **Temperature** Operating: -5 to 65°C

Storage: -30 to 60°C with RTC Battery; -40 to 85°C without RTC Battery

Humidity Operating: 5 to 90% RH

Storage: 5 to 90% RH

MECHANICAL **Dimensions** ATX Form Factor: 305mm (12") x 244mm (9.6")

Height PCB: 1.6mm

► Features

Watchdog Timer

The Watchdog Timer function allows your application to regularly “clear” the system at the set time interval. If the system hangs or fails to function, it will reset at the set time interval so that your system will continue to operate.

DDR4

DDR4 delivers increased system bandwidth and improves performance. The advantages of DDR4 provide an extended battery life and improve the performance at a lower power than DDR3/DDR2.

Graphics

The integrated Intel® HD graphics engine delivers an excellent blend of graphics performance and features to meet business needs. It provides excellent video and 3D graphics with outstanding graphics responsiveness. These enhancements deliver the performance and compatibility needed for today’s and tomorrow’s business applications.

Serial ATA

Serial ATA is a storage interface that is compliant with SATA 1.0a specification. With speed of up to 6Gb/s (SATA 3.0), it improves hard drive performance faster than the standard parallel ATA whose data transfer rate is 100MB/s.

Gigabit LAN

The Gigabit Ethernet Controllers support data transmission at 1Gbps.

Audio

The audio codec provides 5.1 channel High Definition audio output.

Wake-On-LAN

This feature allows the network to remotely wake up a Soft Power Down (Soft-Off) PC. It is supported via the onboard LAN port or via a PCI LAN card that uses the PCI PME (Power Management Event) signal. However, if your system is in the Suspend mode, you can power-on the system only through an IRQ or DMA interrupt.

Wake-On-USB

This function allows you to use a USB keyboard or USB mouse to wake up a system from the S3 (STR - Suspend To RAM) state.

PCI Express

PCI Express is a high bandwidth I/O infrastructure that possesses the ability to scale speeds by forming multiple lanes. The x4 PCI Express lane supports transfer rate of 4 Gigabyte per second (2 directions). The PCI Express architecture also supports high performance graphics infrastructure by enhancing the capability of a PCIe x16 Gen 3 at 16GB/s bandwidth (8GB/s in each direction).

ACPI STR

The system board is designed to meet the ACPI (Advanced Configuration and Power Interface) specification. ACPI has energy saving features that enables PCs to implement Power Management and Plug-and-Play with operating systems that support OS Direct Power Management. ACPI when enabled in the Power Management Setup will allow you to use the Suspend to RAM function.

With the Suspend to RAM function enabled, you can power-off the system at once by pressing the power button or selecting “Standby” when you shut down Windows® without having to go through the sometimes tiresome process of closing files, applications and operating system. This is because the system is capable of storing all programs and data files during the entire operating session into RAM (Random Access Memory) when it powers-off. The operating session will resume exactly where you left off the next time you power-on the system.

Power Failure Recovery

When power returns after an AC power failure, you may choose to either power-on the system manually or let the system power-on automatically.

USB

The system board supports the new USB 3.1 Gen 1. It is capable of running at a maximum transmission speed of up to 5 Gbit/s, or 625 MB/s, faster than USB 2.0 (480 Mbit/s, or 60 MB/s) and USB 1.1 (12Mb/s). USB 3.1 reduces the time required for data transmission, reduces power consumption, and is backward compatible with USB 2.0. It is a marked improvement in device transfer speeds between your computer and a wide range of simultaneously accessible external Plug and Play peripherals.

RTC Timer

The Real Time Clock (RTC) installed on the system board allows your system to automatically power-on on the set date and time.

Chapter 2 - Hardware Installation

▶ Board Layout

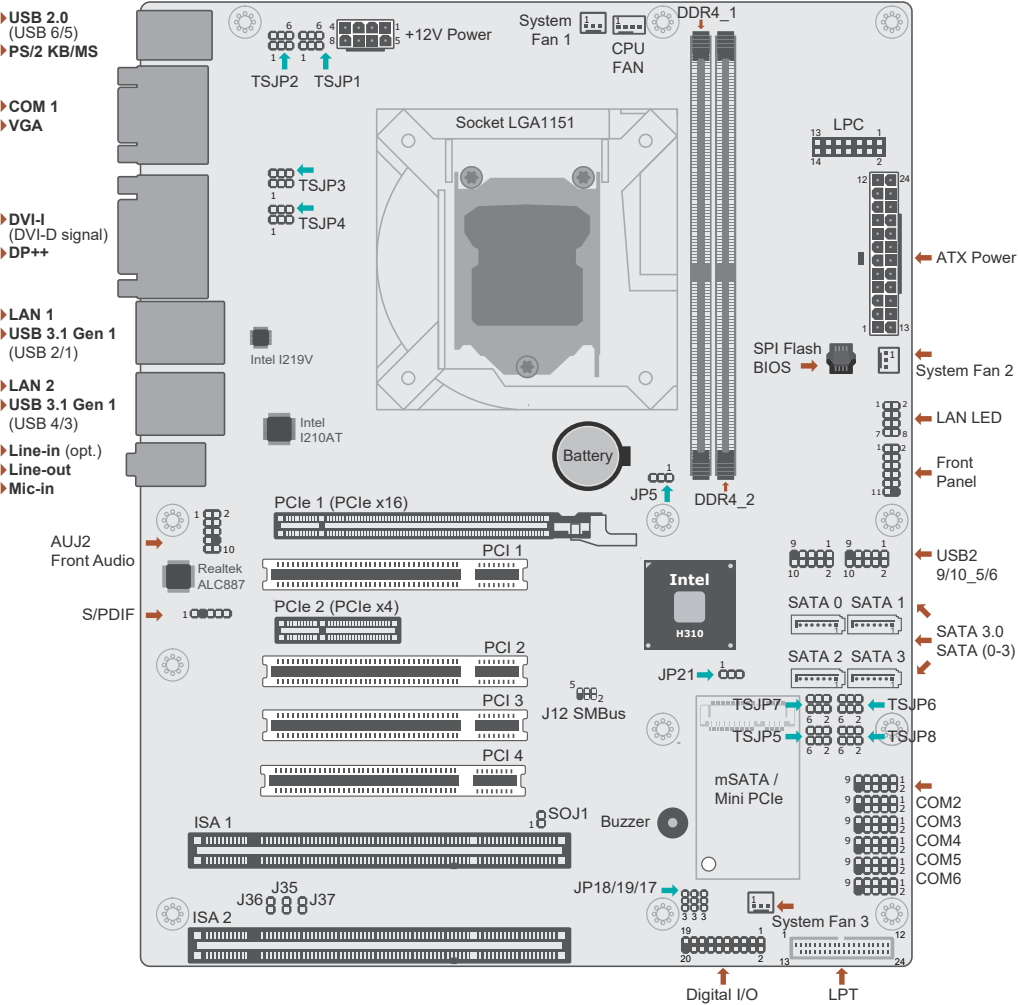

Note:
 Some optional components are only available upon request.

Important:
 Electrostatic discharge (ESD) can damage your board, processor, disk drives, add-in boards, and other components. Perform installation procedures at an ESD workstation only. If such a station is not available, you can provide some ESD protection by wearing an antistatic wrist strap and attaching it to a metal part of the system chassis. If a wrist strap is unavailable, establish and maintain contact with the system chassis throughout any procedures requiring ESD protection.

▶ Standby Power LED

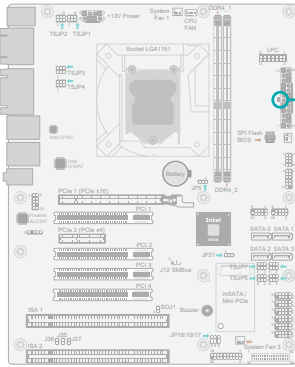

Standby Power LED

Important:
 When the Standby Power LED lit red, it indicates that there is power on the system board. Power-off the PC then unplug the power cord prior to installing any devices. Failure to do so will cause severe damage to the motherboard and components.

► **System Memory**

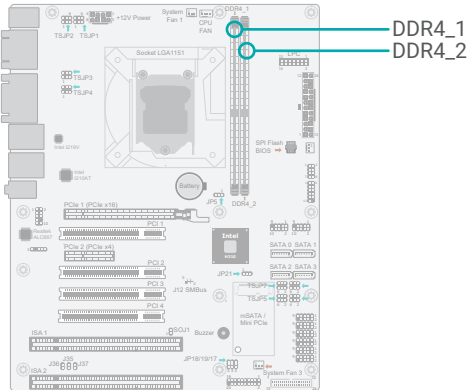

The system board supports the following memory interface.

Single Channel (SC)

Data will be accessed in chunks of 64 bits from the memory channels.

Dual Channel (DC)

Data will be accessed in chunks of 128 bits from the memory channels. Dual channel provides better system performance because it doubles the data transfer rate.

Single Channel DIMMs are on the same channel. DIMMs in a channel can be identical or completely different. However, we highly recommend using identical DIMMs. Not all slots need to be populated.

Dual Channel DIMMs of the same memory configuration are on different channels.

Features

- Two 288-pin UDIMM up to 64GB (non-ECC support)
- Dual Channel DDR4 2400/2666MHz

► **System Memory**

Installing the DIMM Module

Before installing the memory module, please make sure that the following safety cautions are well-attended.

1. Make sure the PC and all other peripheral devices connected to it has been powered down.
2. Disconnect all power cords and cables.
3. Locate the DIMM socket on the system board
4. Make sure the notch on memory card is aligned to the key on the socket.

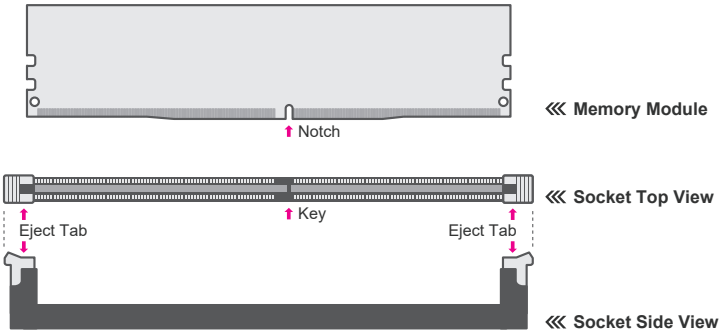

► System Memory ► Installing the DIMM Module

Please follow the steps below to install the memory card into the socket.

Step 1:

Press the eject tabs at both ends of the socket outward and downward to release them from the locked position.

Step 2:

Insert the memory card into the slot while making sure the notch and the key are aligned. Press the card down firmly with fingers while applying and maintaining even pressure on both ends.

Step 3:

The tabs snap automatically to the edges of the card and lock the card in place.

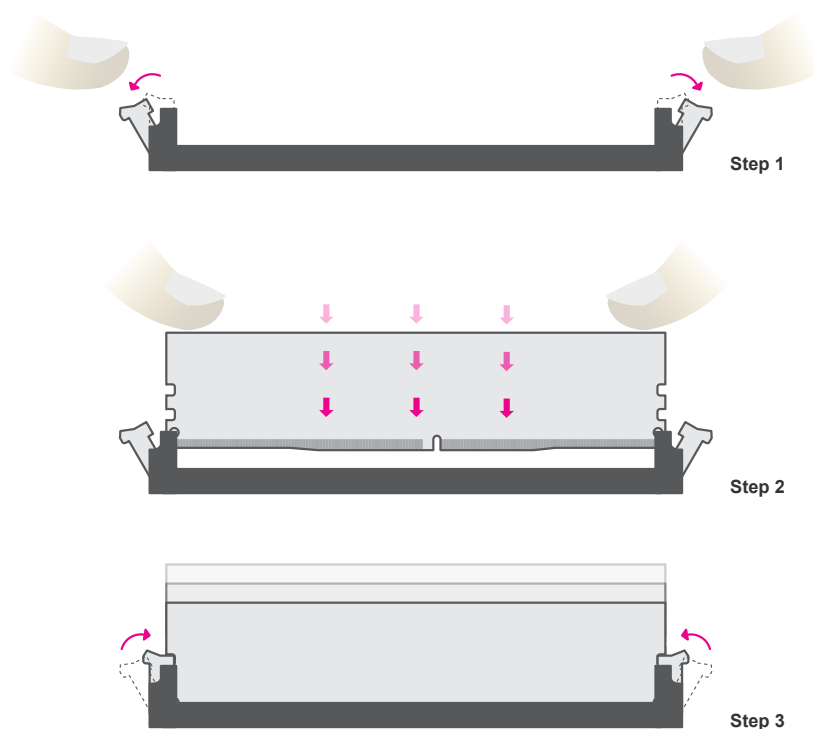

► System Memory

Removing the DIMM Module

Please follow the steps below to remove the memory card from the socket.

Step 1:

Press the eject tabs at both ends of the socket outward and downward to release them from the locked position.

Step 2:

The memory card ejects from the slot automatically.

Step 3:

Hold the card by its edges and remove it from the slot.

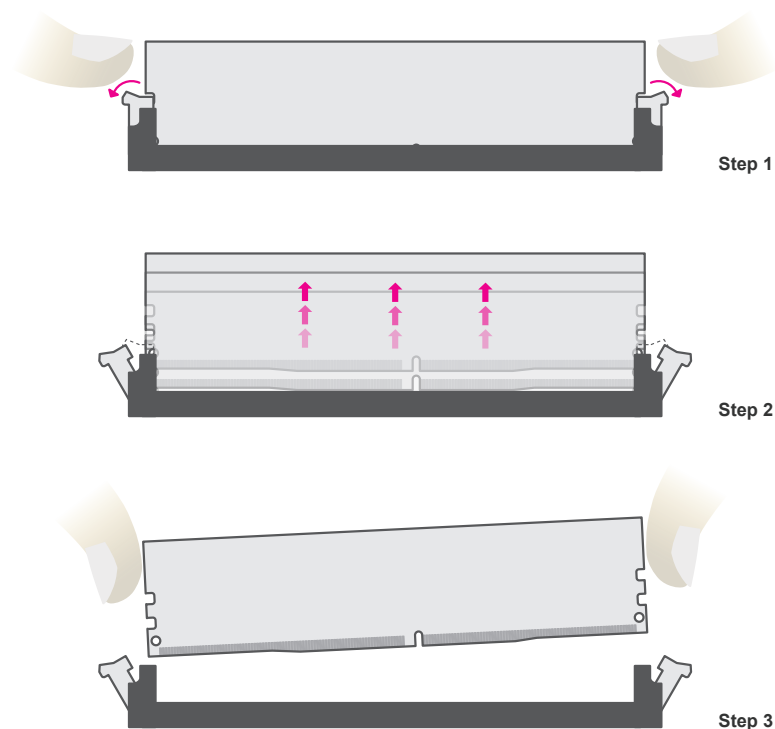

► CPU

The system board is equipped with a surface mount LGA 1151 socket. This socket is exclusively designed for installing a LGA 1151 packaged Intel CPU.



Important:

1. Before you proceed, make sure (1) the LGA 1151 socket comes with a protective cap, (2) the cap is not damaged and (3) the socket's contact pins are not bent. If the cap is missing or the cap and/or contact pins are damaged, contact your dealer immediately.
2. Make sure to keep the protective cap. RMA requests will be accepted and processed only if the LGA 1151 socket comes with the protective cap.

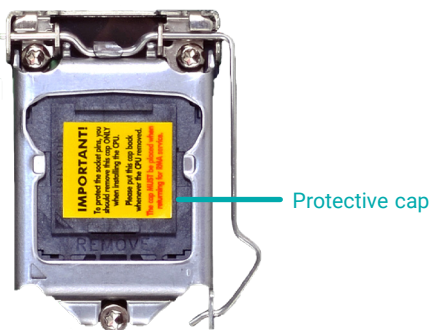

Protective cap



Note:

The system board used in the following illustrations may not resemble the actual board. These illustrations and photos are for reference only.

Installing the CPU

1. Make sure the PC and all other peripheral devices connected to it have been powered down.
2. Disconnect all power cords and cables.

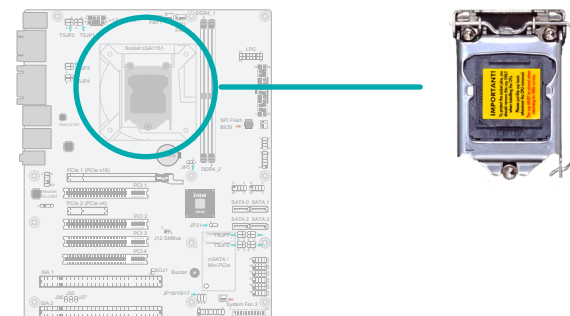

3. Locate the LGA 1151 CPU socket on the system board.



Important:

The CPU socket must not come in contact with anything other than the CPU. Avoid unnecessary exposure. Remove the protective cap only when you are about to install the CPU.

4. Unlock the socket by pressing the load lever down, moving it sideways until it escapes the retention tab. Lift the load lever up when it's released.

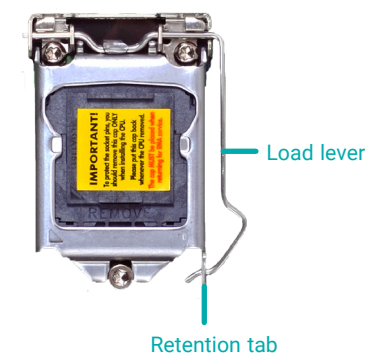

Load lever

Retention tab

► CPU ► Installing the CPU

- 5. Lift the load lever and the load plate all the way up as shown in the photo.
- 6. Remove the protective cap from the CPU socket. The cap is used to protect the CPU socket against dust and harmful particles. Remove the protective cap only when you are about to install the CPU.



- 7-1. Insert the CPU into the socket. The gold triangular mark on the CPU must align with the chamfer corner of the CPU socket shown in the photo.

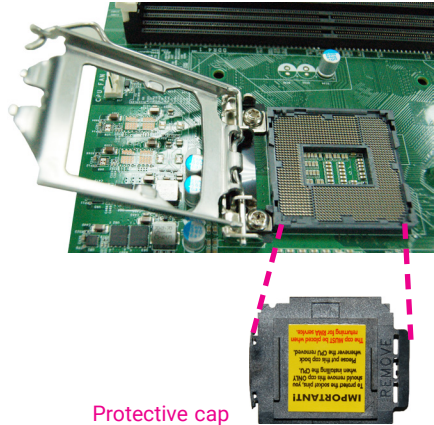

Important:
The CPU will fit in only one orientation and can easily be seated without exerting any force.

► CPU ► Installing the CPU

- 7-2. Two keys on the socket and notches on the CPU also facilitate alignment.

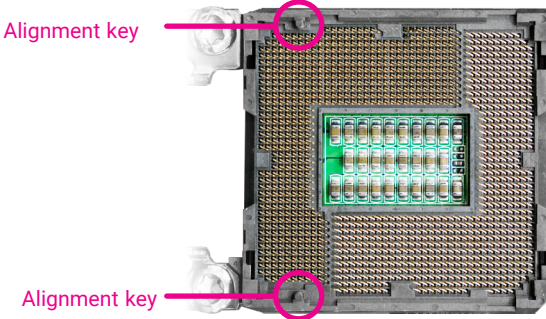

- 7-3. The CPU's notch will fit into the socket's alignment key when it's seated in the correct orientation.

- 8. Close the load plate then push the load lever down.
While closing the load plate, make sure the front edge of the load plate slides under the retention knob.

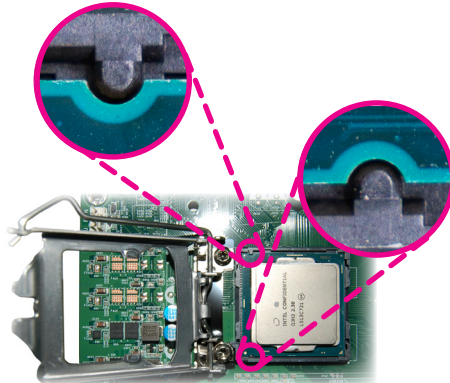

- 9. Press down the load lever and hook it under the retention tab.

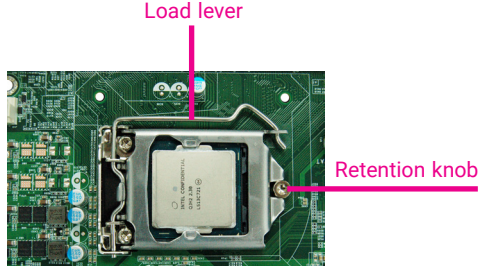

▶ CPU

Installing the Fan and Heat Sink

The CPU must be kept cool by using a CPU fan with heat sink. Without sufficient air circulation across the CPU and heat sink, the CPU will overheat damaging both the CPU and system board.

**Note:**

A boxed Intel® processor already includes the CPU fan and heat sink assembly. If your CPU was purchased separately, make sure to only use Intel®-certified fan and heat sink.

1. Before you install the fan / heat sink, you must apply a thermal paste onto the top of the CPU. The thermal paste is usually supplied when you purchase the fan / heat sink assembly. Do not spread the paste all over the surface. When you later place the heat sink on top of the CPU, the compound will disperse evenly.

Some heat sinks come with a patch of pre-applied thermal paste. Do not apply thermal paste if the fan / heat sink already has a patch of thermal paste on its underside. Peel the strip that covers the paste before you place the fan / heat sink on top of the CPU.

2. Place the heat sink on top of the CPU. The 4 spring screws around the heat sink, which are used to secure the heat sink onto the system board, must match the 4 mounting holes around the socket.
3. Orient the heat sink so that the CPU fan's cable is nearest the CPU fan connector.

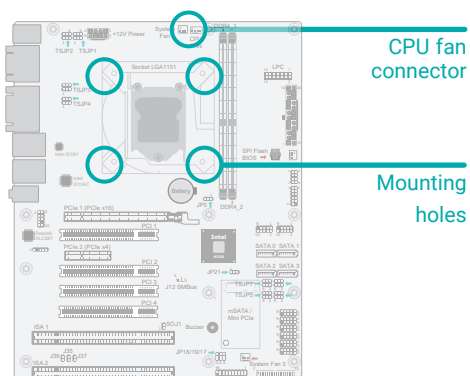

4. Screw tight two of the spring screws at opposite corners into the mounting holes. And then proceed with the other two spring screws.

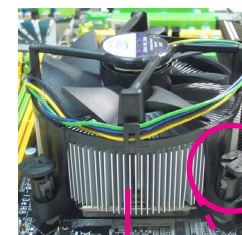

Heat sink

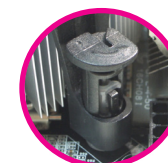

"Locked" position of push-pin

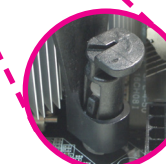

"Unlocked" position of push-pin

5. Connect the CPU fan's cable to the CPU fan connector on the system board.

► Jumper Settings

Clear CMOS

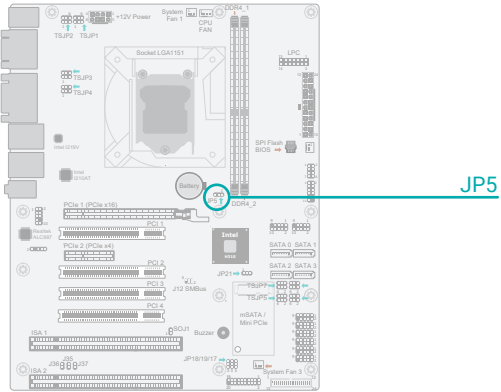

If any anomaly of the followings is encountered –

- a) CMOS data is corrupted;
- b) you forgot the supervisor or user password;
- c) failure to start the system due to BIOS mis-configuration

– it is suggested that the system be reconfigured with default values stored in the ROM BIOS. To load the default values stored in the ROM BIOS, please follow the steps below.

1. Power-off the system and unplug the power cord.
2. Put a jumper cap on pin 2 and pin 3. Wait for a few seconds and set it back to its default setting, i.e. jumper cap on pin 1 and pin 2.
3. Plug the power cord and power-on the system.



■ 1-2 On: Normal (default)



■ 2-3 On: Clear CMOS

COM 1 Serial Mode

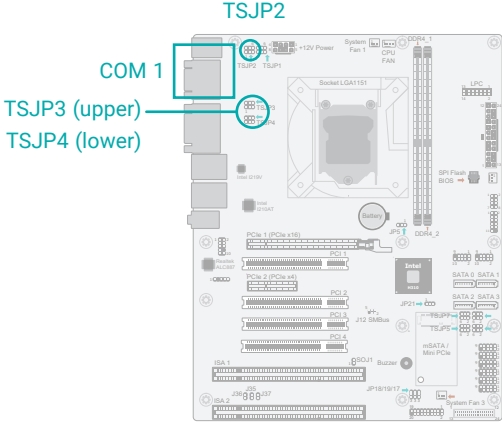

TSJP2, TSJP3, and TSJP4 are used to configure the COM 1 port to RS232, RS422 (Full Duplex) or RS485. These three jumpers must all be configured to the same serial mode.

	RS232 (default)	RS422	RS485
TSJP2	<p>■ 1-3, 4-6 On</p>	<p>■ 3-5, 4-6 On</p>	<p>■ 3-5, 2-4 On</p>
TSJP3 & TSJP4	<p>■ 1-3, 2-4 On</p>	<p>■ 3-5, 4-6 On</p>	<p>■ 3-5, 4-6 On</p>

► Jumper Settings

COM 2 Serial Mode

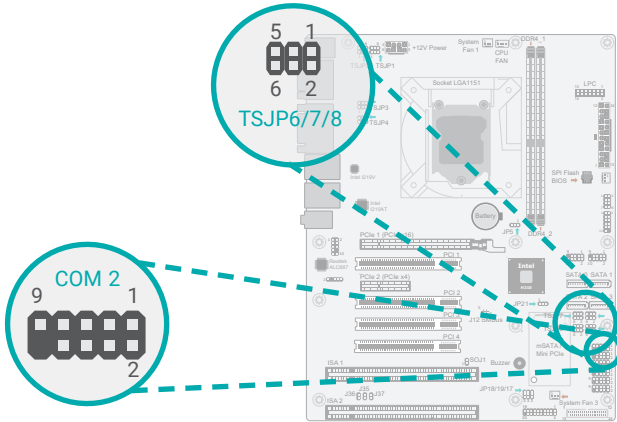

TSJP6, TSJP7, and TSJP8 are used to configure the COM 2 port to RS232, RS422 (Full Duplex) or RS485. The three jumpers must all be configured to the same serial mode.

	RS232 (default)	RS422	RS485
TSJP6	<p>■ 1-3, 4-6 On</p>	<p>■ 3-5, 4-6 On</p>	<p>■ 3-5, 2-4 On</p>
TSJP7 & TSJP8	<p>■ 1-3, 2-4 On</p>	<p>■ 3-5, 4-6 On</p>	<p>■ 3-5, 4-6 On</p>

► Jumper Settings

COM 1/2 RS232 Power Select

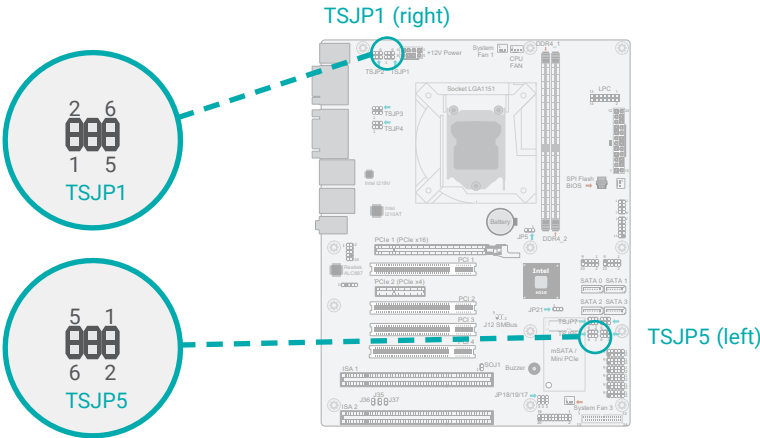

The COM 1 and COM 2 serial ports support RS232 with or without power configured via jumper settings of TSJP1 and TSJP5.

	Standard RS232 (default)	RS232 with Power
TSJP5 (COM2)	<p>■ 2-4 On: Pin 1 = DCD- 1-3 On: Pin 9 = RI-</p>	<p>■ 4-6 On: Pin 1 = +12V 3-5 On: Pin 9 = +5V</p>
TSJP1 (COM1)		

▶ Jumper Settings

SATA port0 / mSATA Switch

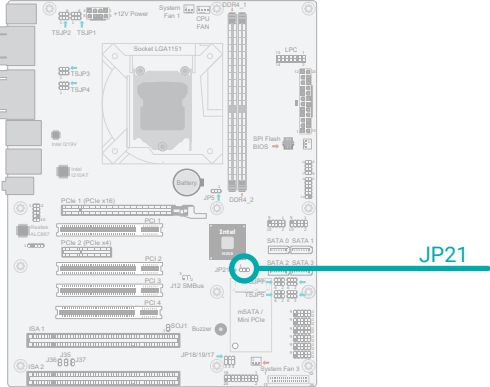

The Mini PCIe bus is shared by a SATA bus and a PCIe bus. This SATA bus can further be directed to either the 7-pin SATA connector, SATA3 or the Mini PCIe connector (mSATA signal) via JP21.



- 1-2 On: 7-pin SATA connector (SATA0)
- 2-3 On: mSATA via Mini PCIe (default)

▶ Jumper Settings

Digital I/O (DIO) Power Supply

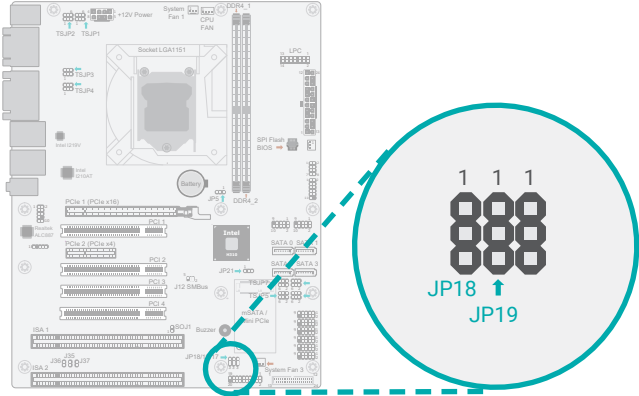

The Digital I/O can be configured to use the power bus of the Digital I/O connector for power supply or not. JP18 is used to select for DIO0~DIO3. JP19 is used to select for DIO4~DIO7.



- 1-2 On: DIO power used (default)
- 2-3 On: GND

► Jumper Settings

Digital I/O (DIO) Power Select

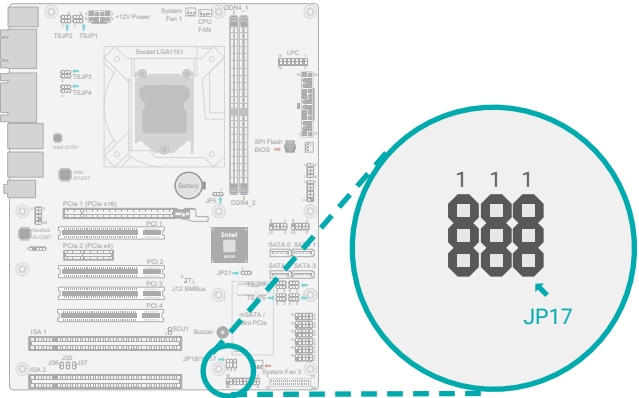

JP17 is used to select the power of Digital I/O: +5V_{DU} (default) or +5V.



■ 1-2 On: +5V_{DU} (default)



■ 2-3 On: +5V

► Rear I/O Ports

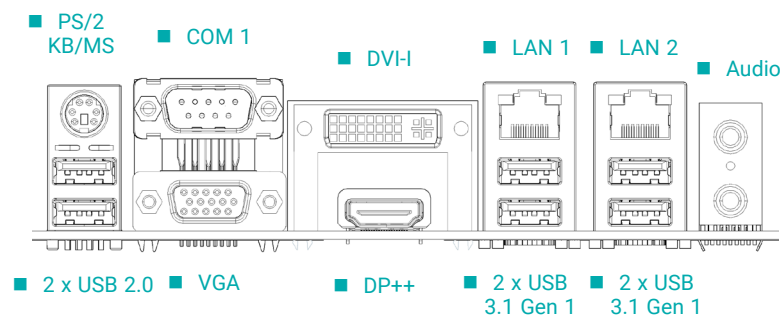

The rear panel I/O ports consist of the following:

- 1 PS/2 Keyboard/Mouse port
- 2 USB 2.0 ports
- 1 Serial COM port (DB9)
- 1 VGA port (DB15)
- 1 DP++ port
- 1 DVI-I port
- 2 LAN ports (RJ45)
- 4 USB 3.1 Gen1 ports
- 1 Line-in jack (optional)
- 1 Line-out jack
- 1 Mic-in jack

► Rear I/O Ports

PS/2 Keyboard/Mouse

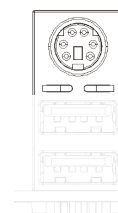

■ PS/2 KB/MS

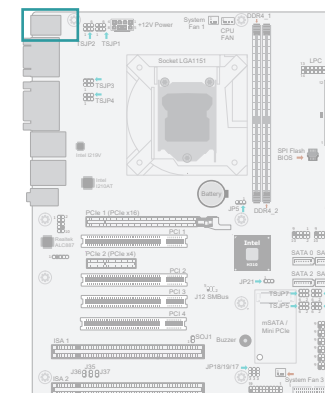

This rear I/O port is used to connect a PS/2 keyboard/mouse. IRQ12 is reserved for the PS/2 mouse connector.

Rear I/O Ports

USB Ports

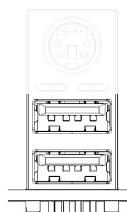

- USB 8 (USB 2.0)
- USB 7 (USB 2.0)

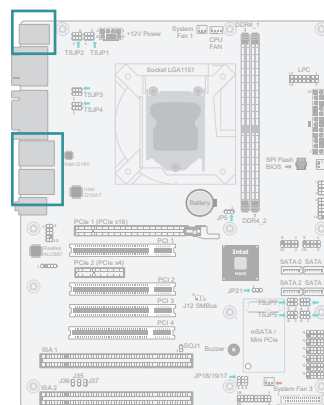

- USB 2 (USB 3.1 Gen 1)
- USB 1 (USB 3.1 Gen 1)

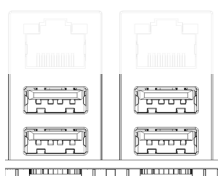

- USB 4 (USB 3.1 Gen 1)
- USB 3 (USB 3.1 Gen 1)

USB allows data exchange between your computer and a wide range of simultaneously accessible external Plug and Play peripherals. The system board is equipped with multiple USB Type A ports at the rear side – two USB 2.0 ports, 4 USB 3.1 Gen1 ports.

Wake-On-USB Keyboard/Mouse

The Wake-On-USB Keyboard/Mouse function allows you to use a USB keyboard or USB mouse to wake up a system from the S3 (STR - Suspend To RAM) state.

Rear I/O Ports

Graphics Display

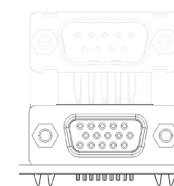

- VGA

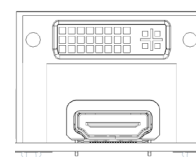

- DVI-I
- DP++

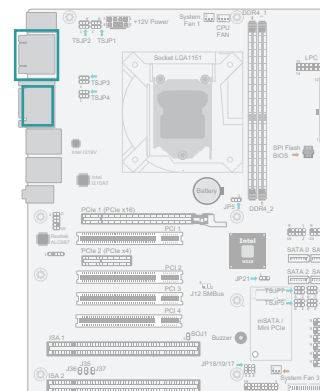

VGA

The VGA port is used for connecting a VGA monitor. Connect the monitor's 15-pin D-shell cable connector to the VGA port. After you plug the monitor's cable connector into the VGA port, gently tighten the cable screws to hold the connector in place.

DisplayPort ++

The DisplayPort (DP) is a digital display interface used to connect a display device such as a computer monitor. It is used to transmit audio and video simultaneously. The interface, which is developed by VESA, delivers higher performance features than any other digital interface. DP++ is supported by the system board for converting to DVI and HDMI signals.

DVI-I

The DVI-I port is used to connect a digital LCD monitor or LCD TV. Connect the display device's cable connector to the port. After you plug the cable connector into the port, gently tighten the cable screws to hold the connector in place.

▶ Rear I/O Ports

RJ45 LAN

■ LAN 1 ■ LAN 2

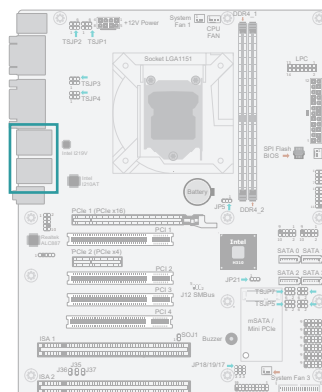
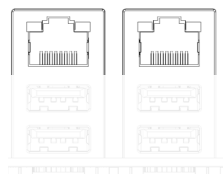

The two LAN ports allow the system board to connect to a local area network.

▶ Rear I/O Ports

Audio

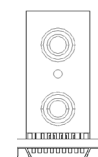

■ Line-out

■ Mic-in

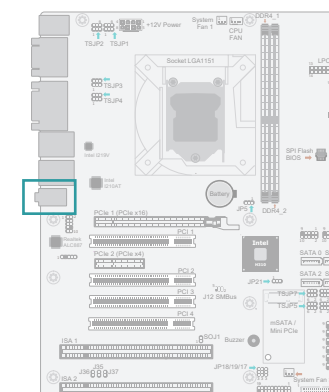

The system board is equipped with two or three rear audio jacks:

- Line-in Jack (Light Blue), optional
This jack is used to connect any audio devices such as Hi-fi set, CD player, tape player, AM/FM radio tuner, synthesizer, etc.
- Line-out Jack (Lime)
This jack is used to connect a headphone or external speakers.
- Mic-in Jack (Pink)
This jack is used to connect an external microphone.

For the internal Front Audio connector, please refer to the next section.

► Rear I/O Ports

COM 1 (Serial) Port

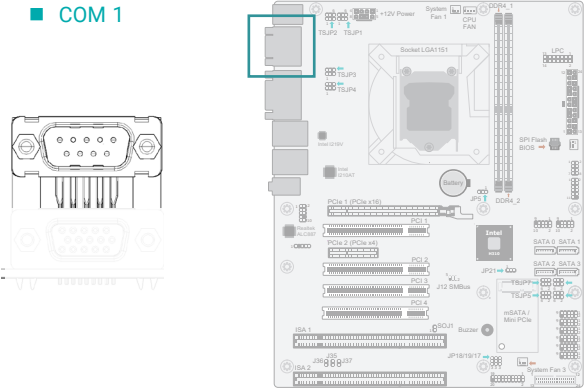

The serial ports are asynchronous communication ports with 16C550A-compatible UARTs that can be used with modems, serial printers, remote display terminals, and other serial devices.

COM 1 supports three serial modes, i.e. RS232, RS422, and RS485, as well as RS232 with/without power.

Jumper Setting

Serial mode and RS232 with/without power of COM 1 are configured via jumper settings as previously instructed in this chapter.



Note: Please refer to the Internal I/O section later in this chapter for more information on the internal COM ports.

► Internal I/O Connectors

COM (Serial) Ports

■ COM 2/3/4/5/6 from left to right

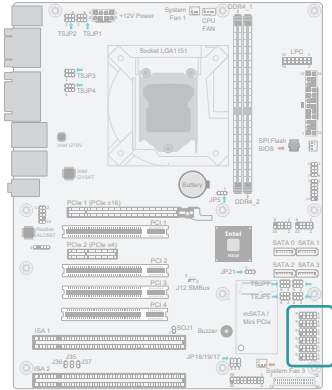

The serial ports are asynchronous communication ports with 16C550A-compatible UARTs that can be used with modems, serial printers, remote display terminals, and other serial devices.

Four of the internal COM (serial) ports, i.e. COM 3/4/5/6, support only RS232 serial mode, while COM 2 supports RS232, RS422, and RS485, as well as RS232 with/without power.

Jumper Setting

Serial mode and RS232 with/without power of COM 2 are configured via jumper settings as previously instructed in this chapter.

■ Internal COM Port Pin Assignment

Pin	Standard RS232	RS232 with Power (COM 2 only)	RS422 (COM 2 only)	RS485 (COM 2 only)
1	DCD-	+12V	RXD+	Data+
2	RD	RD	RXD-	Data-
3	TD	TD	TXD+	N.C.
4	DTR-	DTR-	TXD-	N.C.
5	GND	GND	GND	GND
6	DSR-	DSR-	N.C.	N.C.
7	RTS-	RTS-	N.C.	N.C.
8	CTS-	CTS-	N.C.	N.C.
9	RI-	+5V	N.C.	N.C.

USB Ports

■ USB 9/10 (left), 5/6 (right) (USB 2.0)

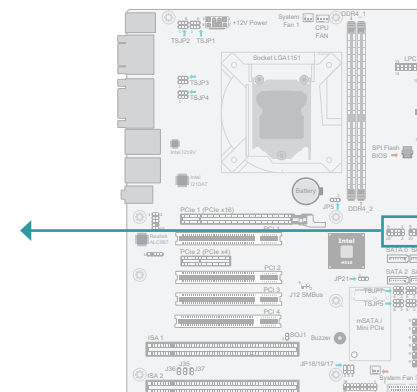

The USB device allows data exchange between your computer and a wide range of simultaneously accessible external Plug and Play peripherals.

In addition to the rear USB ports as introduced previously in this chapter, the system board is equipped with 2 internal USB 2.0 ports as illustrated above.

The internal USB pin headers may be connected to a card-edge bracket. Install the card-edge bracket to an available slot at the rear of the system chassis and then insert the USB port cables to a connector.

Wake-On-USB Keyboard/Mouse

The Wake-On-USB Keyboard/Mouse function allows you to use a USB keyboard or USB mouse to wake up a system from the S state(s).

Internal I/O Connectors

Front Audio

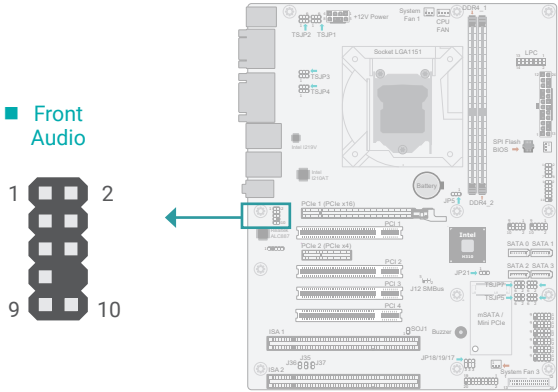

The Front Audio internal connector allows you to connect to the second line-out and mic-in jacks that are at the front panel of your system.

Front Audio Pin Assignment

Pin	Assignment	Pin	Assignment
1	Mic2-L	2	GND
3	Mic2-R	4	N.C.
5	Line2-R	6	Mic2-JD
7	Front I/O Sense	8	---
9	Line2-L	10	Line2-JD

Internal I/O Connectors

SATA (Serial ATA)

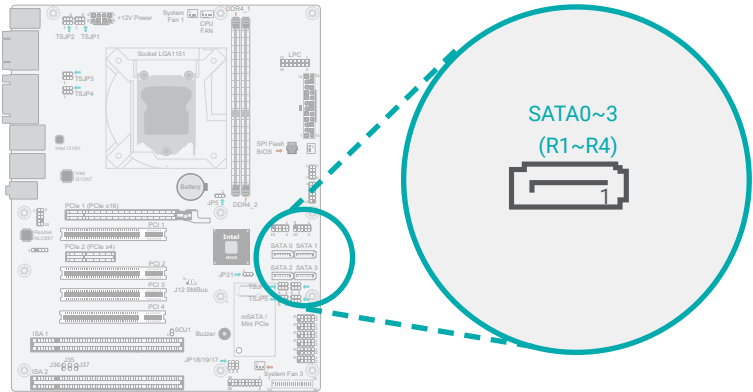

The Serial ATA (SATA) connectors are used to connect the Serial ATA device. SATA 3.0 is supported by the five SATA ports and provides data rate up to 6Gb/s. Connect one end of the Serial ATA cable to a SATA connector and the other end to your Serial ATA device.

Jumper Setting

A SATA bus is either terminated at SATA3 or Mini PCIe (mSATA), and is configured via JP21 as previously instructed in this chapter.

SATA Pin Assignment



Note: The SATA bus of SATA3 (R5) is shared with Mini PCIe (mSATA), and will be inactive when the SATA bus is directed to Mini PCIe (mSATA).

Internal I/O Connectors

Digital I/O

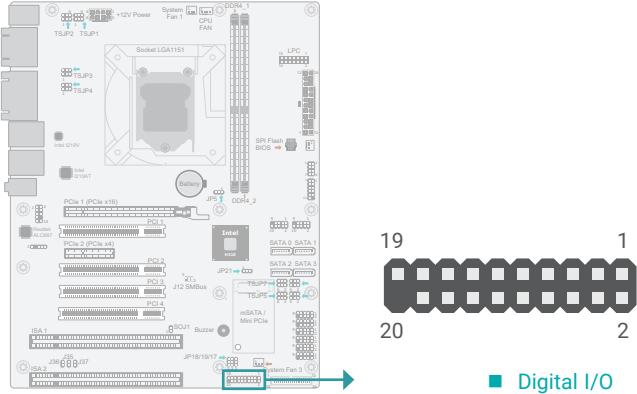

The 8-bit Digital I/O (DIO) connector allows for input/output signals of digital logical states defined by voltage levels.

Jumper Setting

DIO signal and power can be configured via jumper settings as previously instructed in this chapter.

Digital I/O Pin Assignment

Pin	Assignment	Pin	Assignment
1	GND	2	+12V
3	DIO_7	4	+12V
5	DIO_6	6	GND
7	DIO_5	8	+5V
9	DIO_4	10	+5V
11	DIO_3	12	GND
13	DIO_2	14	+5V _{DU}
15	DIO_1	16	+5V _{DU}
17	DIO_0	18	GND
19	GND	20	---

Internal I/O Connectors

Cooling Fan Connectors

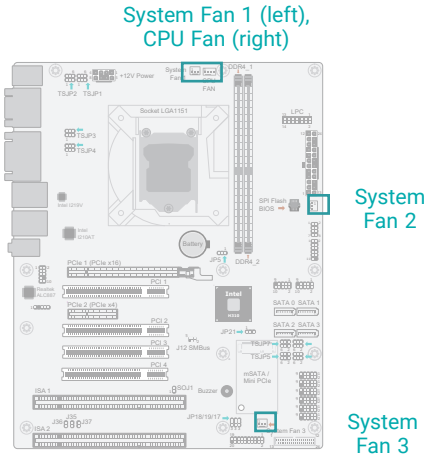

These fan connectors are used to connect to cooling fans. Cooling fans provide adequate air circulation throughout the chassis and dissipate heat to prevent overheating of the system board and components. The 4-pin fan provides PWM to modulate fan speed whereas the 3-pin fans modulate fan speed via voltage modulation.

BIOS Setting

Configure the Smart Fans in the Advanced menu ("SIO NUVOTON6116D" submenu) of the BIOS. Refer to chapter 3 for more information.

3-pin Fan Pin Assignment

Pin	Assignment
1	Ground
2	Power
3	Sense

4-pin Fan Pin Assignment

Pin	Assignment
1	Ground
2	Power
3	Sense
4	Speed Control

Internal I/O Connectors

Power Connector

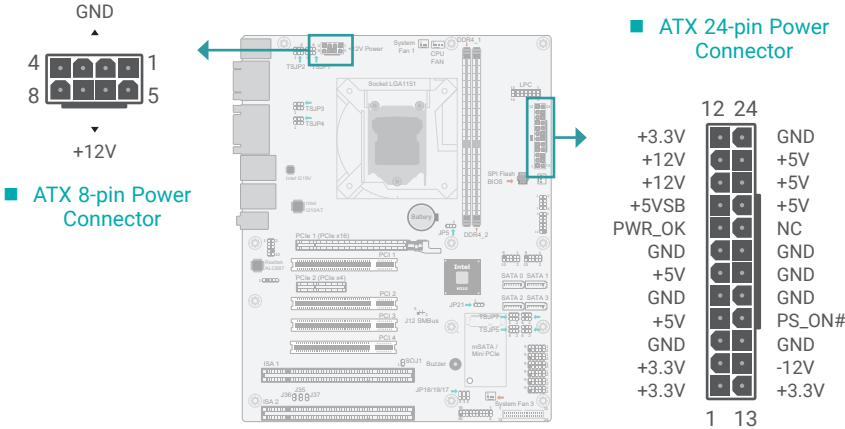

Use a power supply that complies with the ATX12V Power Supply Design Guide Version 1.1. An ATX12V power supply unit has a standard 24-pin ATX main power connector that must be inserted into the 24-pin connector. The 8-pin +12V power connector enables the delivery of more +12VDC current to the processor's Voltage Regulator Module (VRM).

The power connectors from the power supply unit are designed to fit the 24-pin and 8-pin connectors in only one orientation. Make sure to find the proper orientation before plugging the connectors.

The system board requires a minimum of 300 Watt power supply to operate. Your system configuration (CPU power, amount of memory, add-in cards, peripherals, etc.) may exceed the minimum power requirement. To ensure that adequate power is provided, we strongly recommend that the system is supplied with a minimum of 400 Watt power.



Important:

Insufficient power supplied to the system may result in instability or malfunction of the add-in boards and peripherals. Calculating the system's approximate power usage is important to ensure that the power supply meets the system's consumption requirements.

Internal I/O Connectors

Chassis Intrusion

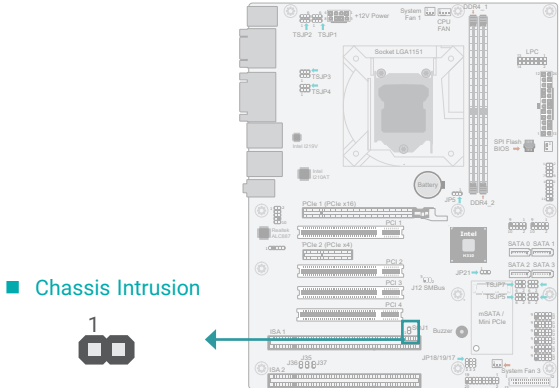

The board supports the chassis intrusion detection function. Connect the chassis intrusion sensor cable from the chassis to this connector. When the system's power is on and a chassis intrusion occurred, an alarm will sound. When the system's power is off and a chassis intrusion occurred, the alarm will sound only when the system restarts.

Chassis Intrusion Pin Assignment

Pin	Assignment	Pin	Assignment
1	Signal	2	GND

Internal I/O Connectors

Front Panel

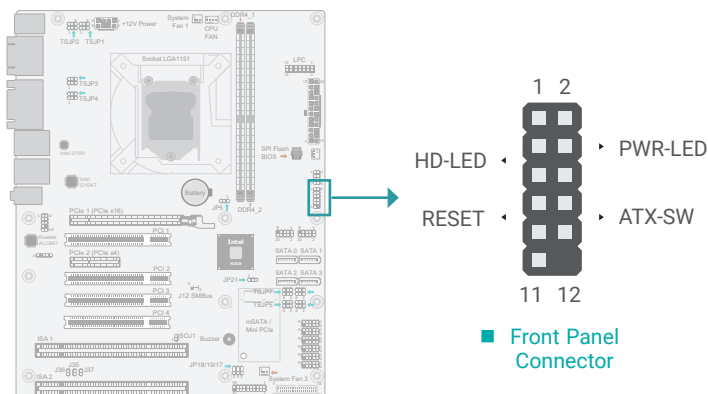

Front Panel Pin Assignment

Pin	Assignment	Pin	Assignment	
1	N.C.	2	LED Power	
3	HDD Power	PWR-LED	4	LED Power
5	Signal		6	Signal
7	Ground	ATX-SW	8	Ground
9	Signal		10	Signal
11	N.C.	12	---	

HDD-LED - Hard Disk Drive LED

Lighting of the LED indicates that the hard drive is being accessed.

RESET - Reset Switch

This switch allows you to reboot without having to power off the system.

PWR-LED - Power/Standby LED

When the system's power is on, this LED will light up. When the system is in the S1 (POS - Power On Suspend) state, it will blink at 1-second intervals. When the system is in the S3 (STR - Suspend To RAM) state, it will blink at 4-second intervals.

ATX-SW - ATX Power Switch

This switch is used to power on or off the system.

Internal I/O Connectors

S/PDIF

S/PDIF Connector

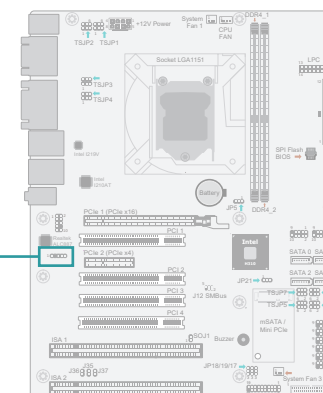

The Sony/Philips Digital Interface (S/PDIF) connector is for audio output to external audio equipment. The S/PDIF port may be mounted on a card-edge bracket. Install the card-edge bracket to an available slot at the rear of the system chassis then connect the audio cable to the S/PDIF connector. Make sure pin 1 of the audio cable is aligned with pin 1 of the S/PDIF connector.

S/PDIF Pin Assignment

Pin	Assignment
1	+5V
2	---
3	SPDIF Out
4	GND
5	SPDIF In

Internal I/O Connectors

Battery

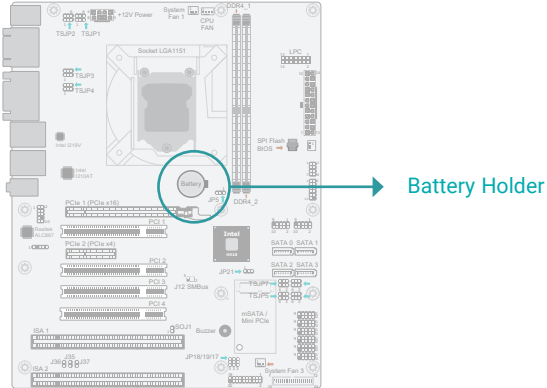

The lithium ion battery addendum supplies power to the real-time clock and CMOS memory as an auxiliary source of power when the main power is shut off. Insert a coin cell battery into the holder and make sure the polarities are correctly oriented — the cap side (rimmed rounded edge) is negative and should be facing the holder; the flat side with a + mark is positive and should be facing away from the holder.

Safety Measures

- There exists explosion hazard if the battery is incorrectly installed.
- Replace only with the same or equivalent type recommended by the manufacturer.
- Dispose of used batteries according to local ordinances.

Internal I/O Connectors

SMBus

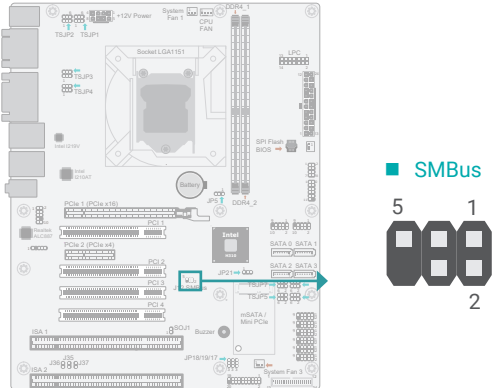

The SMBus (System Management Bus) connector is used to connect the SMBus device. It is a multiple device bus that allows multiple chips to connect to the same bus and enable each one to act as a master by initiating data transfer.

SMBus Pin Assignment

Pin	Assignment	Pin	Assignment
1	3V3DU	2	GND
3	SMBus_Clock	4	SMBus_DATA
5	SMBus_Alert	6	---

Internal I/O Connectors

LPC

The LPC connector is used for debugging.

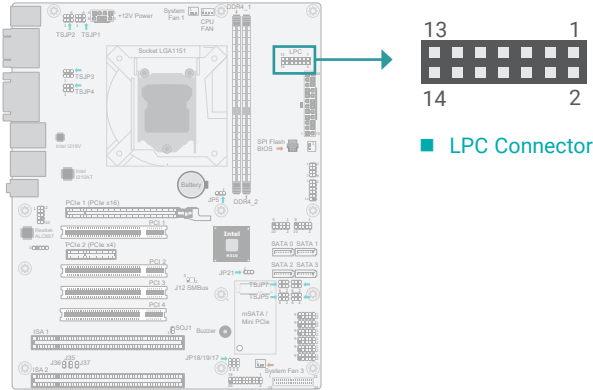

LPC Connector

LPC Pin Assignment

Pin	Assignment	Pin	Assignment
1	L_CLK	2	L_LAD1
3	L_RST#	4	L_LAD0
5	L_FRAME#	6	3.3V
7	L_LAD3	8	GND
9	L_LAD2	10	---
11	SERIRQ	12	GND
13	5VSB	14	5V

Internal I/O Connectors ▶ LPC

External COM port Module

The external COM port modules – EXT-RS232 and EXT-RS485 – are designed by DFI’s proprietary technology, and support four additional COM ports per module. The EXT-RS232/RS485 card is connected to the motherboard via the LPC connector and secured by a standoff as illustrated below.

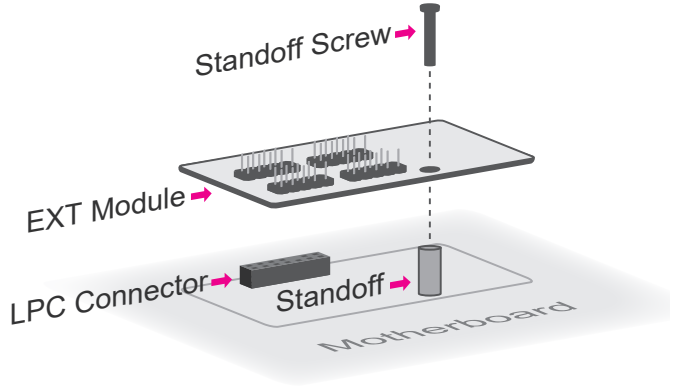
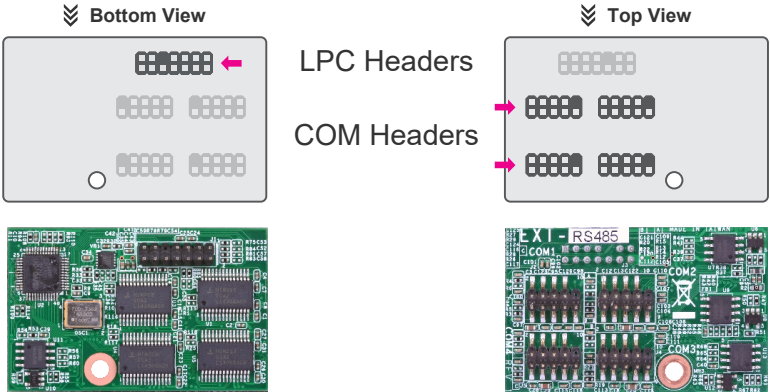

Note: The EXT-RS232/RS485 modules are optional peripherals that are not included in the standard package. For more information, please contact DFI sales representatives or visit go.dfi.com/EXT-RS232, and go.dfi.com/EXT-RS485.

Internal I/O Connectors

LAN LED

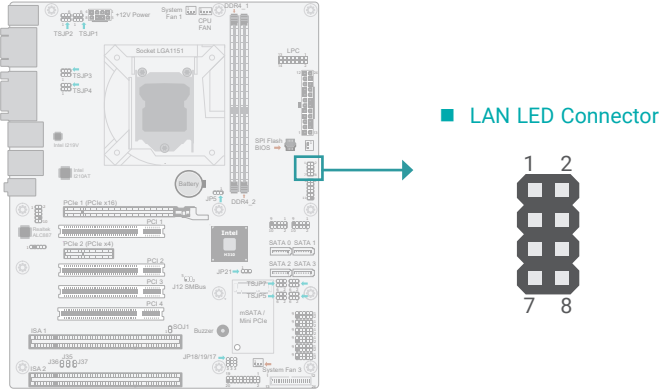

The LAN LED connector is used to detect the connection state of RJ45 LAN ports when the connection is made to an active network via a cable. The pin functions of the LAN LED connector are listed below.

LAN LED Pin Assignment

Pin	Assignment	Pin	Assignment
1	GBE(LAN1)_1000	2	GBE(LAN1)_100
3	GBE(LAN1)_LED_LINK_ACT	4	3V3DU
5	LINK(LAN2)_1000	6	LINK(LAN2)_100
7	LINK(LAN2)_ACTIVITY	8	3V3DU

Internal I/O Connectors

Expansion Slots

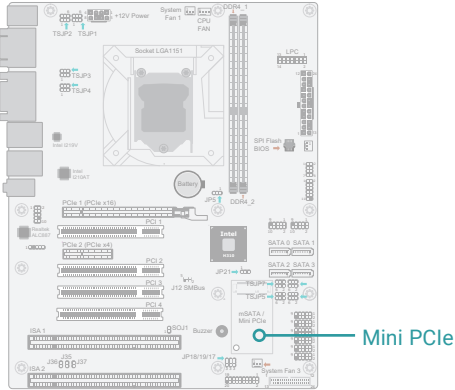

Mini PCIe

The Mini PCIe socket allows for a full-size Mini PCIe module. The Mini PCIe supports PCIe, SATA, and USB signals.

Jumper Setting

Select the signal of Mini PCIe via jumper settings as previously instructed in this chapter.

► Internal I/O Connectors ► Expansion Slots

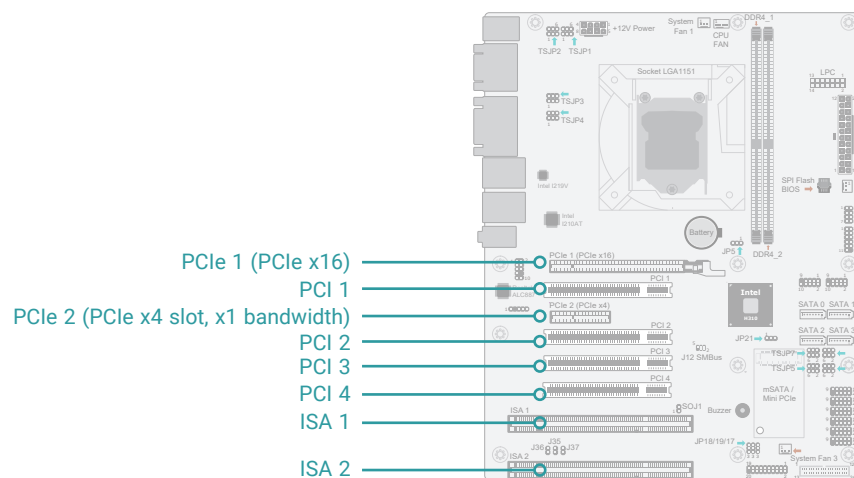

PCI Express x16 Slot

Install a PCI Express x16 graphics card that complies to the PCI Express specifications into the PCI Express x16 slot. To install a graphics card into the x16 slot, align the graphics card to the socket and perpendicularly to the board, be cautious in aligning the locations of notch and key, and then press the card down firmly until it is completely seated. The retaining clip of the slot will close up automatically to hold the graphics card in place.

PCI Express x4 Slot

Install PCI Express cards such as network cards or other cards that comply to the PCI Express specifications into the PCI Express x4 slot.

PCI Slot

The two PCI slots support expansion cards that comply with PCI specifications. You can install a PCI expansion card or a customized riser card designed for only 2 PCI slots expansion (for low profile PCI card only) into the PCI slot.

ISA Slot

The ISA slot is used to connect ISA-compatible expansion cards.

► Internal I/O Connectors ► Expansion Slots

Installing the Mini PCIe Module

Before installing the Mini PCIe module into the Mini PCIe socket, please make sure that the following safety cautions are well-attended.

1. Make sure the PC and all other peripheral devices connected to it has been powered down.
2. Disconnect all power cords and cables.
3. Locate the Mini PCIe socket on the system board
4. Make sure the notch on card is aligned to the key on the socket.

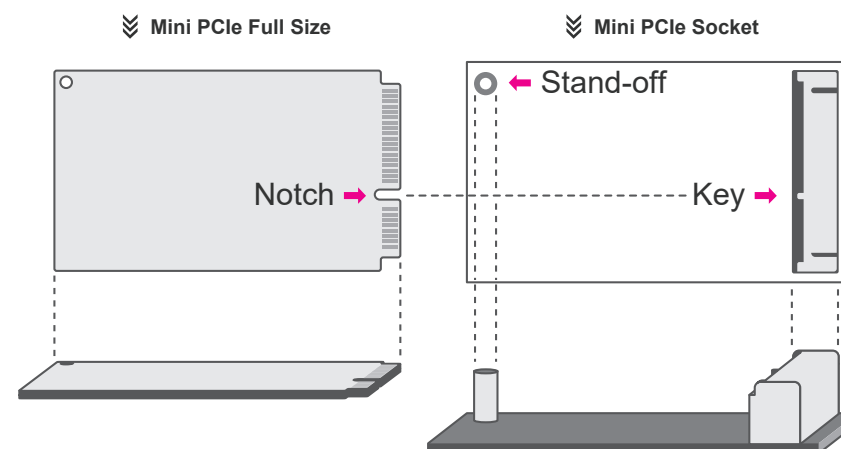

Chapter 3 - BIOS Settings

► Overview

The BIOS is a program that takes care of the basic level of communication between the CPU and peripherals. It contains codes for various advanced features found in this system board. The BIOS allows you to configure the system and save the configuration in a battery-backed CMOS so that the data retains even when the power is off. In general, the information stored in the CMOS RAM of the EEPROM will stay unchanged unless a configuration change has been made such as a hard drive replaced or a device added.

It is possible that the CMOS battery will fail causing CMOS data loss. If this happens, you need to install a new CMOS battery and reconfigure the BIOS settings.



The BIOS is constantly updated to improve the performance of the system board; therefore the BIOS screens in this chapter may not appear the same as the actual one. These screens are for reference purpose only.

Default Configuration

Most of the configuration settings are either predefined according to the Load Optimal Defaults settings which are stored in the BIOS or are automatically detected and configured without requiring any actions. There are a few settings that you may need to change depending on your system configuration.

Entering the BIOS Setup Utility

The BIOS Setup Utility can only be operated from the keyboard and all commands are keyboard commands. The commands are available at the right side of each setup screen.

The BIOS Setup Utility does not require an operating system to run. After you power up the system, the BIOS message appears on the screen and the memory count begins. After the memory test, the message "Press DEL to run setup" will appear on the screen. If the message disappears before you respond, restart the system or press the "Reset" button. You may also restart the system by pressing the <Ctrl> <Alt> and keys simultaneously.

Legends

Keys	Function
Right / Left arrow	Move the highlight left or right to select a menu
Up / Down arrow	Move the highlight up or down between submenus or fields
<Enter>	Enter the highlighted submenu
+ (plus key)/F6	Scroll forward through the values or options of the highlighted field
- (minus key)/F5	Scroll backward through the values or options of the highlighted field
<F1>	Display general help
<F2>	Display previous values
<F9>	Optimized defaults
<F10>	Save and Exit
<Esc>	Return to previous menu

Scroll Bar

When a scroll bar appears to the right of the setup screen, it indicates that there are more available fields not shown on the screen. Use the up and down arrow keys to scroll through all the available fields.

Submenu

When "►" appears on the left of a particular field, it indicates that a submenu which contains additional options are available for that field. To display the submenu, move the highlight to that field and press <Enter>.

► Main

The Main menu is the first screen that you will see when you enter the BIOS Setup Utility.

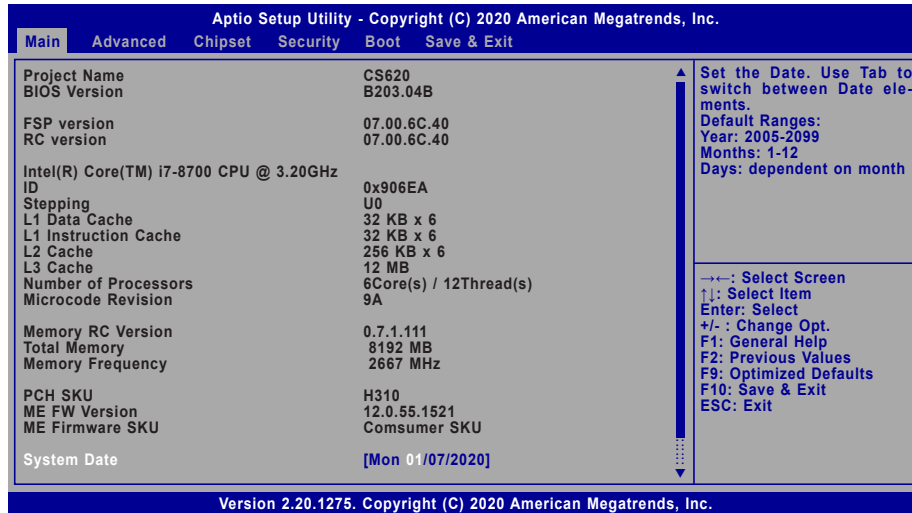

System Date

The date format is <month>, <date>, <year>. Press "Tab" to switch to the next field and press "-" or "+" to modify the value.

System Time

The time format is <hour>, <minute>, <second>. The time is based on the 24-hour military-time clock. For example, 1 p.m. is 13:00:00. Hour displays hours from 00 to 23. Minute displays minutes from 00 to 59. Second displays seconds from 00 to 59.

► Advanced

The Advanced menu allows you to configure your system for basic operation. Some entries are defaults required by the system board, while others, if enabled, will improve the performance of your system or let you set some features according to your preference.



Important:

Setting incorrect field values may cause the system to malfunction.

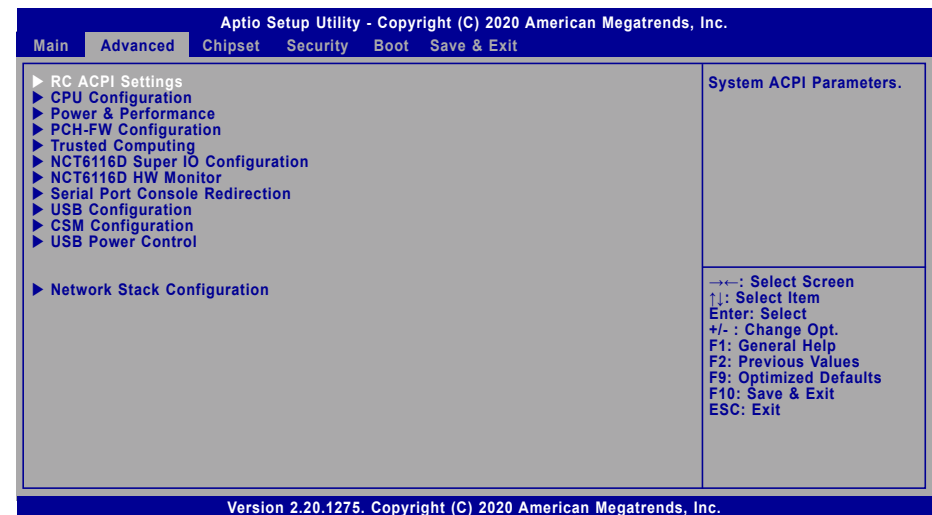

▶ Advanced

RC ACPI Configuration

Aptio Setup Utility - Copyright (C) 2020 American Megatrends, Inc.		
Advanced		
RC ACPI Configuration		Enable or disable System wake on alarm event. When enabled, System will wake on the hr:min::sec specified
Wake system from S5 via RTC	[Enabled]	
Wake up hour	0	→←: Select Screen ↑↓: Select Item Enter: Select +/-: Change Opt. F1: General Help F2: Previous Values F9: Optimized Defaults F10: Save & Exit ESC: Exit
Wake up minute	0	
Wake up second	0	
State After G3	[S0 State]	
Version 2.20.1275. Copyright (C) 2020 American Megatrends, Inc.		

Wake system from S5 via RTC

When Enabled, the system will automatically power up at a designated time every day. Once it's switched to [Enabled], please set up the time of day — hour, minute, and second — for the system to wake up.

State After G3

Select between S0 State, and S5 State. This field is used to specify what state the system is set to return to when power is re-applied after a power failure (G3 state).

- S0 State** The system automatically powers on after power failure.
- S5 State** The system enter soft-off state after power failure. Power-on signal input is required to power up the system.
- Last State** The system returns to the last state right before power failure.

▶ Advanced

CPU Configuration

Aptio Setup Utility - Copyright (C) 2020 American Megatrends, Inc.		
Advanced		
CPU Configuration		When enabled, a VMM can utilize the additional hardware capabilities provided by Vanderpool Technology.
Intel (VMX) Virtualization Technology	[Enable]	
Active Processor Cores	[All]	→←: Select Screen ↑↓: Select Item Enter: Select +/-: Change Opt. F1: General Help F2: Previous Values F9: Optimized Defaults F10: Save & Exit ESC: Exit
Hyper-Threading	[Enable]	
Version 2.20.1275. Copyright (C) 2020 American Megatrends, Inc.		

Intel (VMX) Virtualization Technology

When this field is set to Enabled, the VMM can utilize the additional hardware capabilities provided by Vanderpool Technology.

Active Processor Cores

Select number of cores to enable in each processor package: all or 1.

Hyper-threading

Enables this field for OS which is optimized for Hyper-Threading technology. Select disabled for other OSes not optimized for Hyper-Threading technology. When disabled, only one thread per enabled core is enabled.



Note:

Some of the fields may not be available when the features are not supported by the equipped CPU.

▶ Advanced

Power & Performance

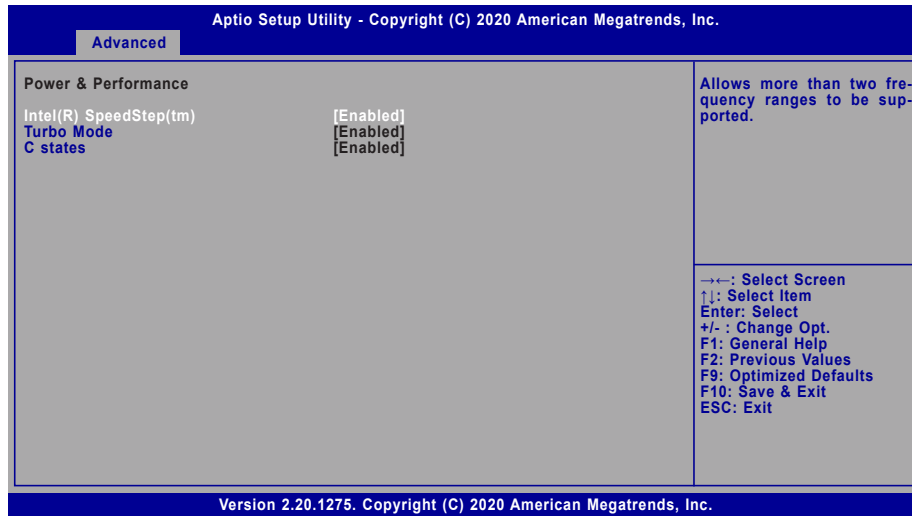

Intel(R) SpeedStep(tm)

This field is used to enable or disable the Intel SpeedStep® Technology, which helps optimize the balance between system’s power consumption and performance. After it is enabled in the BIOS, EIST features can then be enabled via the operating system’s power management.

Turbo Mode

Enable or disable turbo mode of the processor. This field will only be displayed when EIST is enabled.

C states

Enable or disable CPU Power Management. It allows CPU to enter "C states" when it's idle and nothing is executing.

▶ Advanced

PCH-FW Configuration

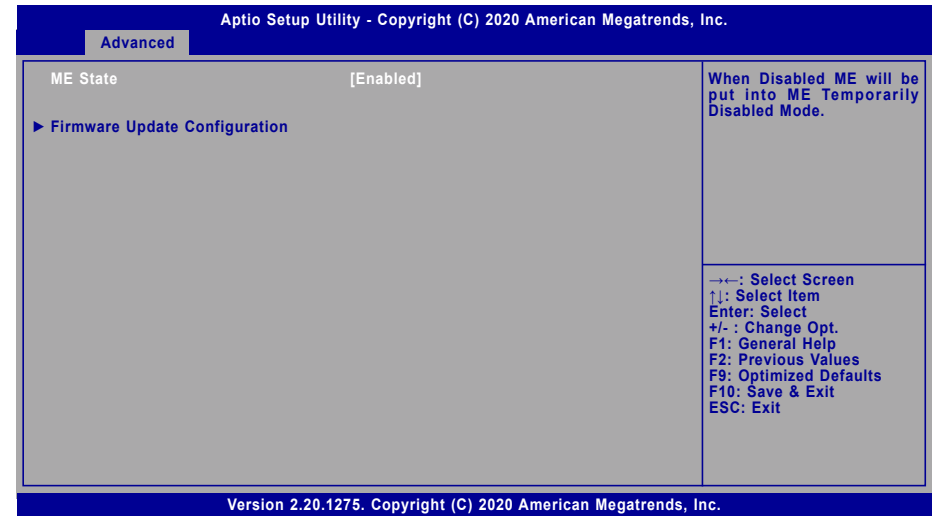

ME State

When this field is set to Disabled, ME will be put into ME Temporarily Disabled Mode.



Note:

The sub-menus are detailed in following sections.

▶ Advanced ▶ PCH-FW Configuration

▶ Firmware Update Configuration

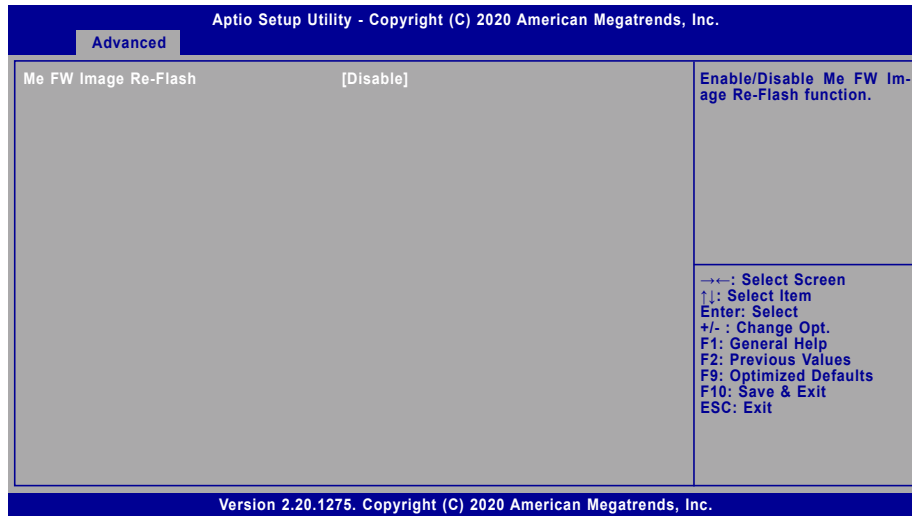

Me FW Image Re-Flash

This field is used to enable or disable the ME FW Image Re-Flash function, which allows the user to update the ME firmware.

▶ Advanced

Trusted Computing

Aptio Setup Utility - Copyright (C) 2020 American Megatrends, Inc.		
Advanced		
TPM20 Device Found	5.62	Enables or Disables BIOS support for security device. O.S will not show Security Device. TCG EFI protocol and INT1A interface will not be available.
Firmware Version	IFX	
Security Device Support	[Enable]	→←: Select Screen ↑↓: Select Item Enter: Select +/-: Change Opt. F1: General Help F2: Previous Values F9: Optimized Defaults F10: Save & Exit ESC: Exit
Pending operation	[None]	

Version 2.20.1275. Copyright (C) 2020 American Megatrends, Inc.

Security Device Support

This field is used to enable or disable BIOS support for the security device such as an TPM 2.0 to achieve hardware-level security via cryptographic keys.

Pending operation

To clear the existing TPM encryption, select "TPM Clear" and restart the system. This field is not available when "Security Device Support" is disabled.

▶ Advanced

NCT6116D Super IO Configuration

Aptio Setup Utility - Copyright (C) 2020 American Megatrends, Inc.		
Advanced		
NCT6116D Super IO Configuration		WatchDog Timer Unit Selection
Super IO Chip	NCT6116D	
WatchDog Timer Unit	[Second]	→←: Select Screen ↑↓: Select Item Enter: Select +/-: Change Opt. F1: General Help F2: Previous Values F9: Optimized Defaults F10: Save & Exit ESC: Exit
SuperIO WatchDog Timer	0	
▶ Serial Port 1 Configuration ▶ Serial Port 2 Configuration ▶ Serial Port 3 Configuration ▶ Serial Port 4 Configuration ▶ Serial Port 5 Configuration ▶ Serial Port 6 Configuration ▶ Parallel Port Configuration		

Version 2.20.1275. Copyright (C) 2020 American Megatrends, Inc.

WatchDog Timer Unit

Select WatchDog Timer Unit – Second or Minute.

SuperIO WatchDog Timer

Set SuperIO WatchDog Timer Timeout value. The range is from 0 (disabled) to 255.



Note:

The sub-menus are detailed in following sections.

▶ Serial Port 1/2/3/4/5/6 and Parallel Port Configuration

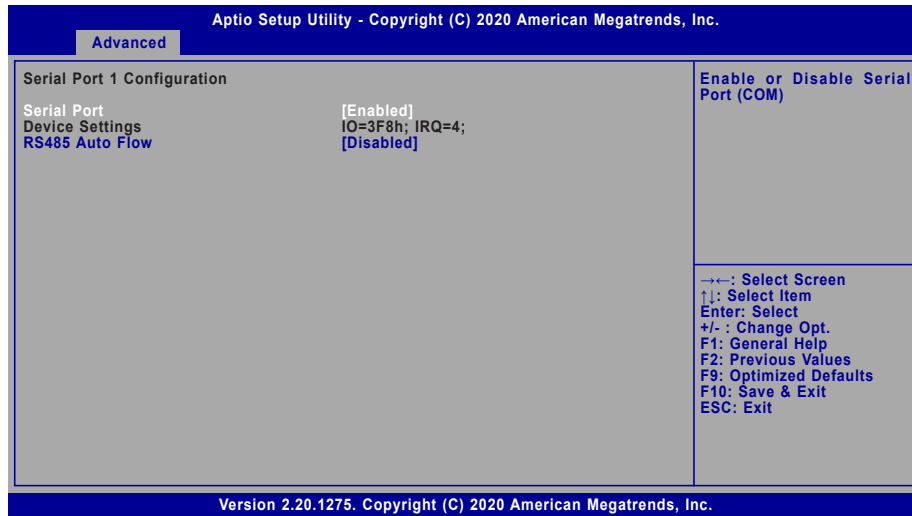

Serial Port

Enable or disable the current serial COM port.

RS485 Auto Flow

Enable or disable RS485 auto flow. This field is only available for COM ports that support RS485 mode.

NCT6116D HW Monitor

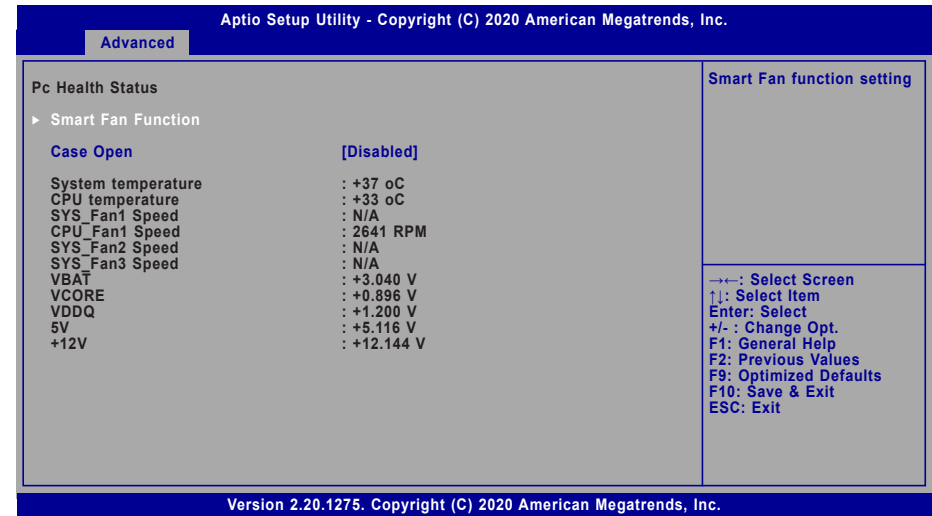

This section displays the system's health information, i.e. voltage readings, CPU and system temperatures, and fan speed readings.

Case Open

Enable or disable the case open detection function.

▶ Smart Fan Function

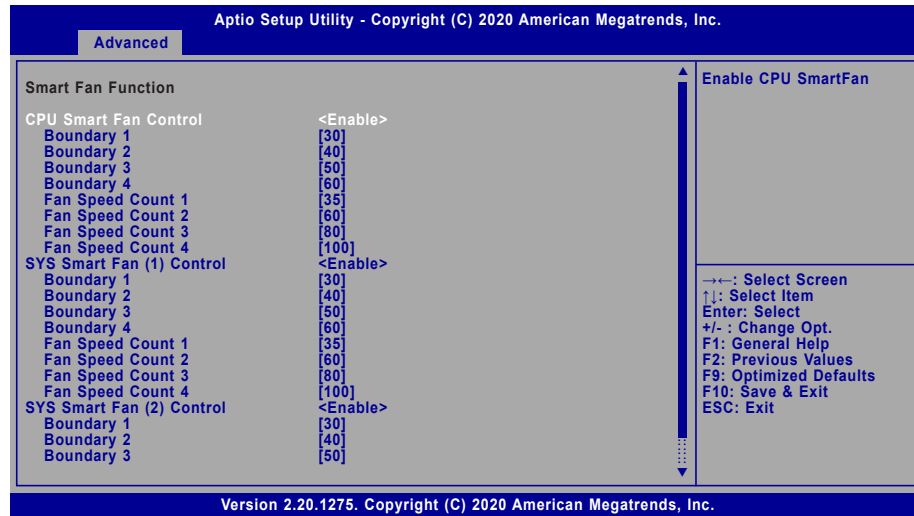

Smart Fan is a fan speed moderation strategy dependent on the current system temperature. When the system temperature goes higher than the Boundary setting, the fan speed will be turned up to the setting of the Fan Speed Count that bears the same index as the Boundary field.

▼ **SYS Smart Fan/CPU Smart Fan Control = [Enabled]**

Boundary 1 to Boundary 4

Set the boundary temperatures that determine the fan speeds accordingly, the value ranging from 0-127°C. For example, when the system temperature reaches Boundary 1 setting, the fan speed will be turned up to the designated speed of the Fan Speed Count 1 field.

Fan Speed Count 1 to Fan Speed Count 4

Set the fan speed, the value ranging from 1-100%, 100% being full speed. The fans will operate according to the specified boundary temperatures above-mentioned.

▼ **SYS Smart Fan/CPU Smart Fan Control = [Disabled]**

Fix Fan Speed Count

Set the fan speed, the value ranging from 1-100%, 100% being full speed. The fans will always operate at the specified speed regardless of gauged temperatures.

Serial Port Console Redirection

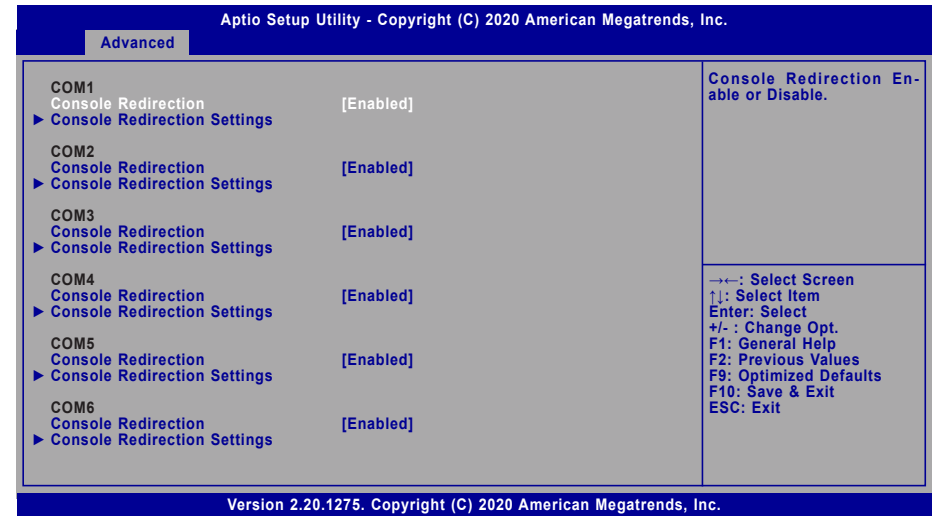

Console Redirection

By enabling Console Redirection of a COM port, the sub-menu of console redirection settings will become available for configuration as detailed in the following.

▶ Console Redirection Settings

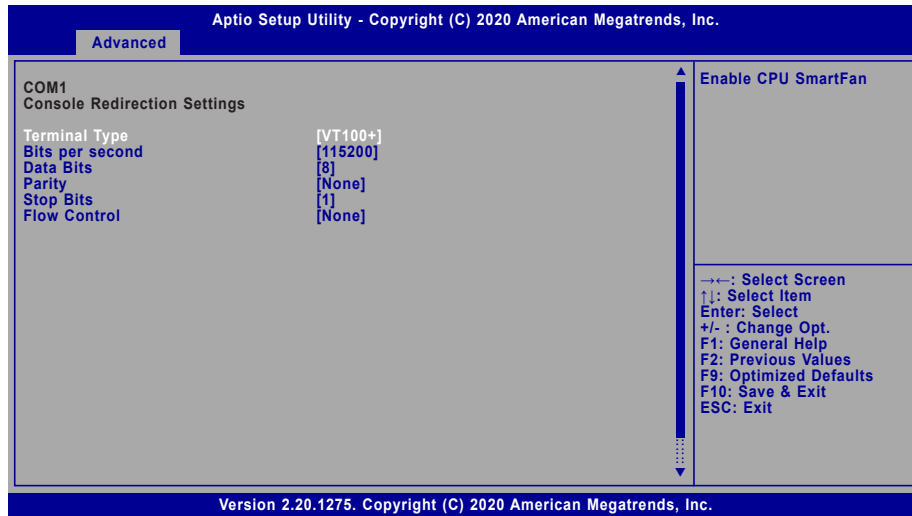

Configure the serial settings of the current COM port.

Terminal Type

Select terminal type: VT100, VT100+, VT-UTF8 or ANSI.

Bits per second

Select serial port transmission speed: 9600, 19200, 38400, 57600 or 115200.

Data Bits

Select data bits: 7 bits or 8 bits.

Parity

Select parity bits: None, Even, Odd, Mark or Space.

Stop Bits

Select stop bits: 1 bit or 2 bits.

Flow Control

Select flow control type: None or Hardware RTS/CTS. Flow Control is for RS485 mode and is only supported by Serial Port 1 (COM1).

USB Configuration

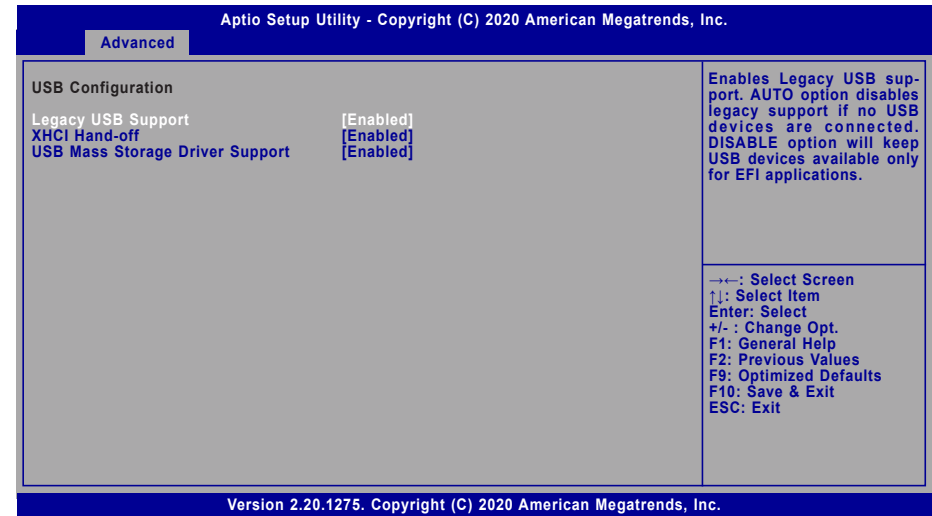

Legacy USB Support

- Enabled** Enable Legacy USB support.
- Disabled** Keep USB devices available only for EFI applications.
- Auto** Disable Legacy support if no USB devices are connected.

XHCI Hand-off

Enable or disable XHCI Hand-off.

USB Mass Storage Driver Support

Enable or disable USB Mass Storage Driver Support.

▶ Advanced

CSM Configuration

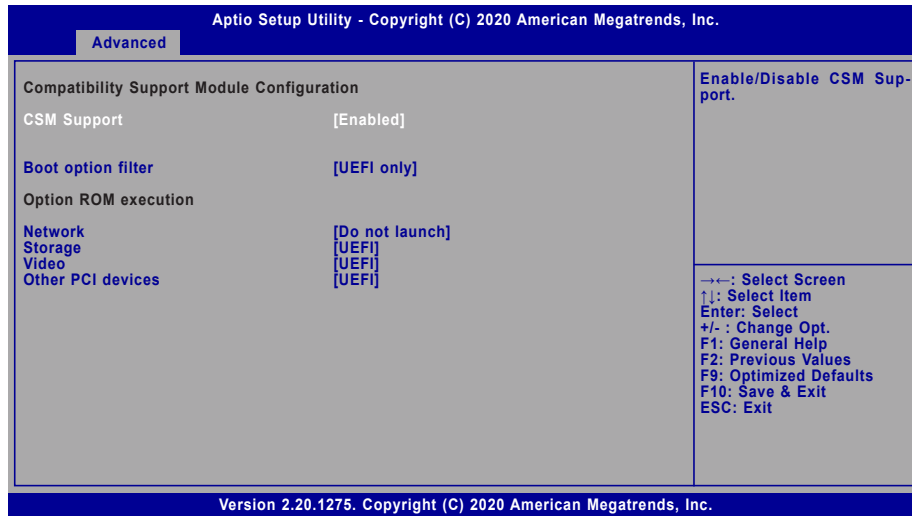

CSM Support

This section is used to enable or disable CSM Support. The following fields are only available when "CSM Support" is enabled.

Boot option filter

This field controls Legacy/UEFI ROMs priority. Select among UEFI and Legacy, Legacy only or UEFI only.

Network

This field controls the execution of UEFI and Legacy Network OpROM.

Storage

This field controls the execution of UEFI and Legacy Storage OpROM.

Video

This field controls the execution of UEFI and Legacy Video OpROM.

Other PCI devices

This field determines OpROM execution policy for devices other than Network, Storage or Video.

▶ Advanced

USB Power Control

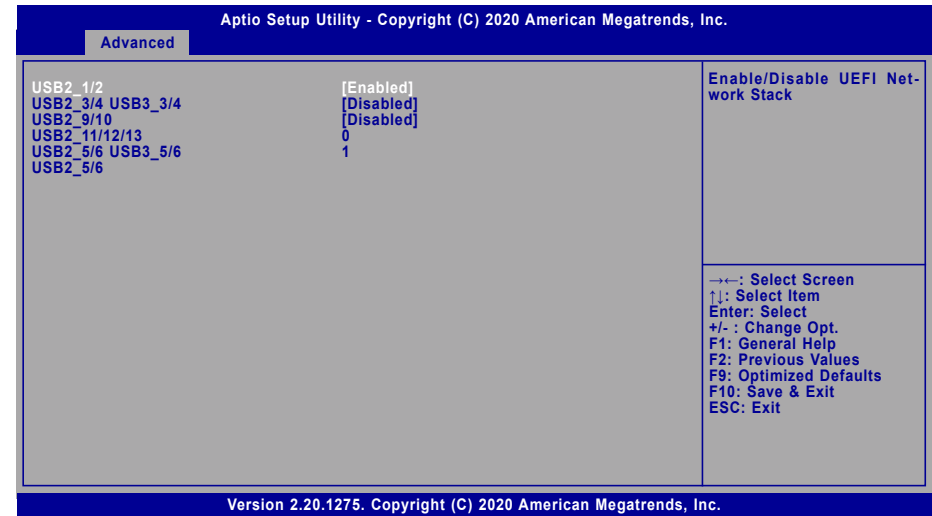

Select between 5V_Dual (5VDU) and 5V for the USB power channel of each USB connector. To support Wake-on-USB, please select 5V_Dual.

► **Advanced**

Network Stack Configuration

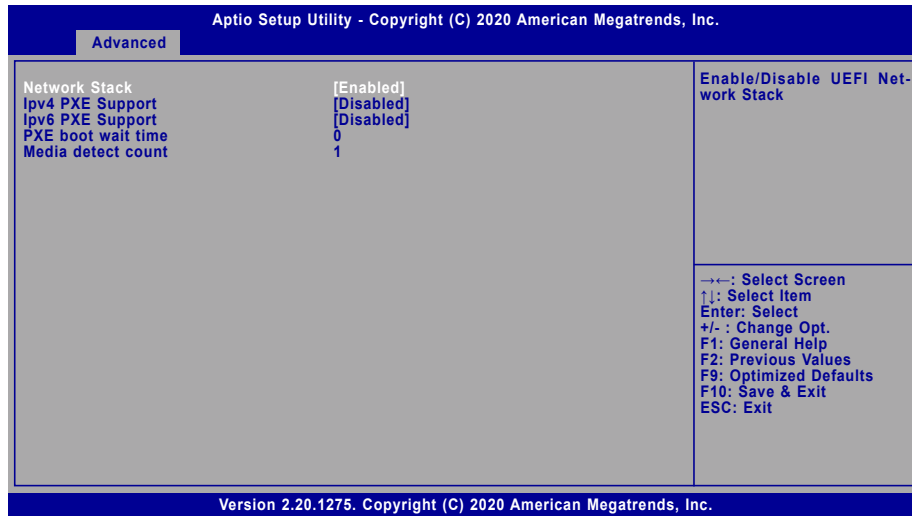

Network Stack

Enable or disable UEFI network stack. The following fields will appear when this field is enabled.

Ipv4 PXE Support

Enable or disable IPv4 PXE boot support. If disabled, IPv4 PXE boot support will not be available.

Ipv6 PXE Support

Enable or disable IPv6 PXE boot support. If disabled, IPv6 PXE boot support will not be available.

PXE boot wait time

Set the wait time in seconds to press ESC key to abort the PXE boot. Use either +/- or numeric keys to set the value.

Media detect count

Set the number of times the presence of media will be checked. Use either +/- or numeric keys to set the value.

► **Chipset**

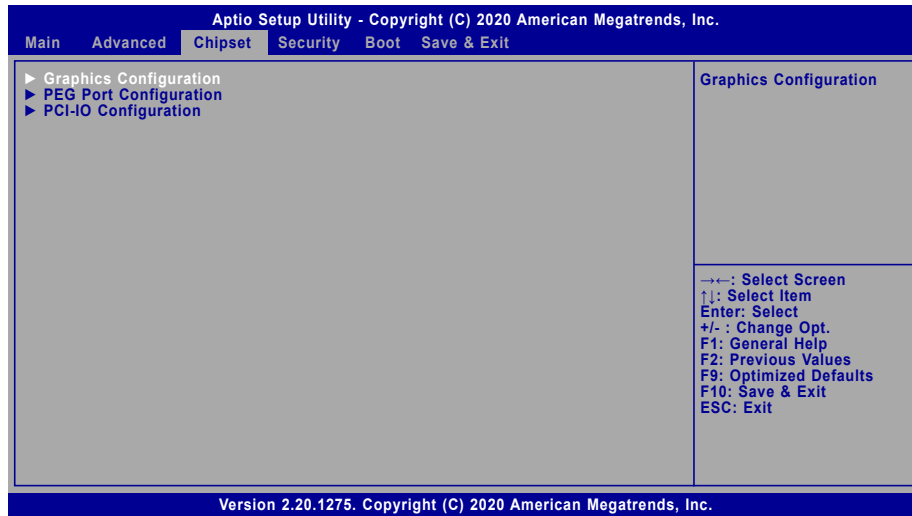

Please select a submenu and press Enter. The submenus are detailed in the following pages.

► **Chipset**

Graphics Configuration

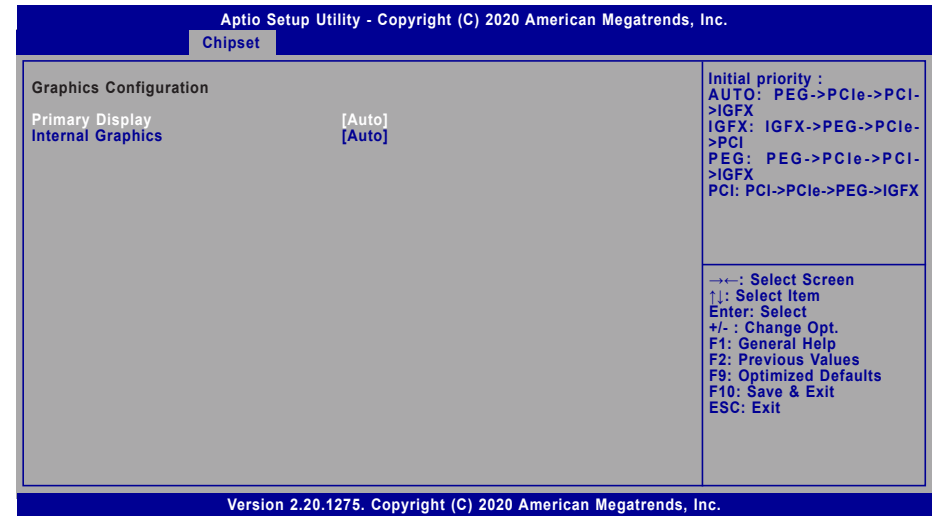

Primary Display

Select which of IGFX/PEG/PCI Graphics device to be the primary display.

Internal Graphics

Keep IGFX "Enabled" or "Disabled" based on the setup options, or select "Auto" for auto-detection.

► Chipset

PEG Port Configuration

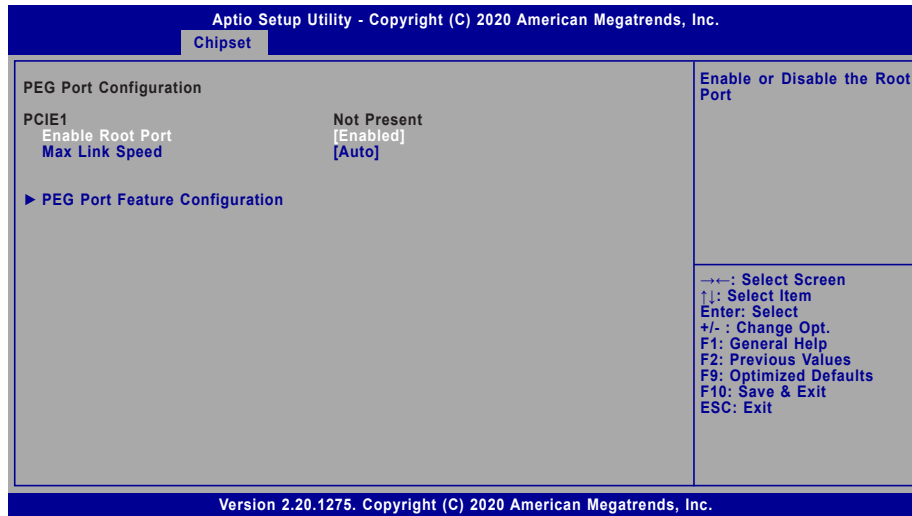

Enable Root Port

Enable or disable the root port, or select "Auto" for auto-detection.

Max Link Speed

Configure PCIe1 port's Max Speed: Auto, Gen1, Gen2 or Gen3.

► PEG Port Feature Configuration

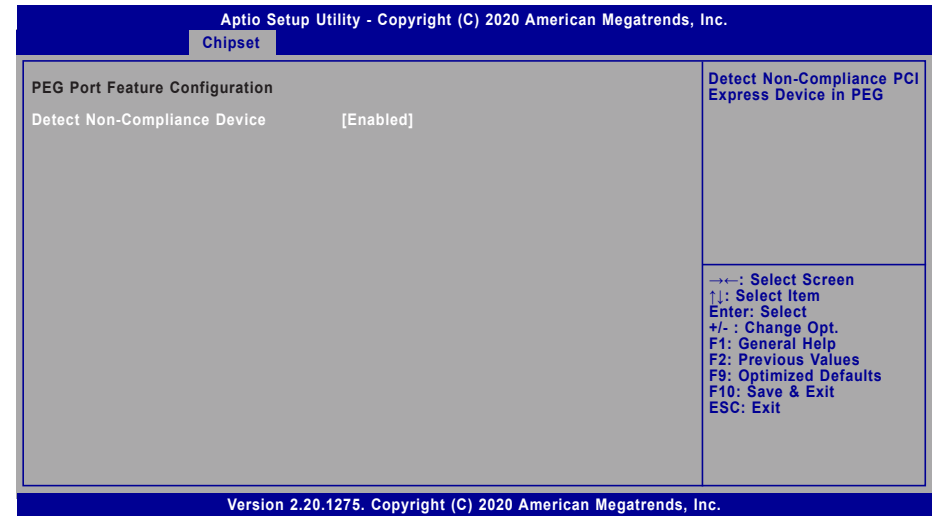

Detect Non-Compliance Device

Enable or disable this field to detect non-compliance PCIe devices in the PEG.

▶ Chipset

PCH-IO Configuration

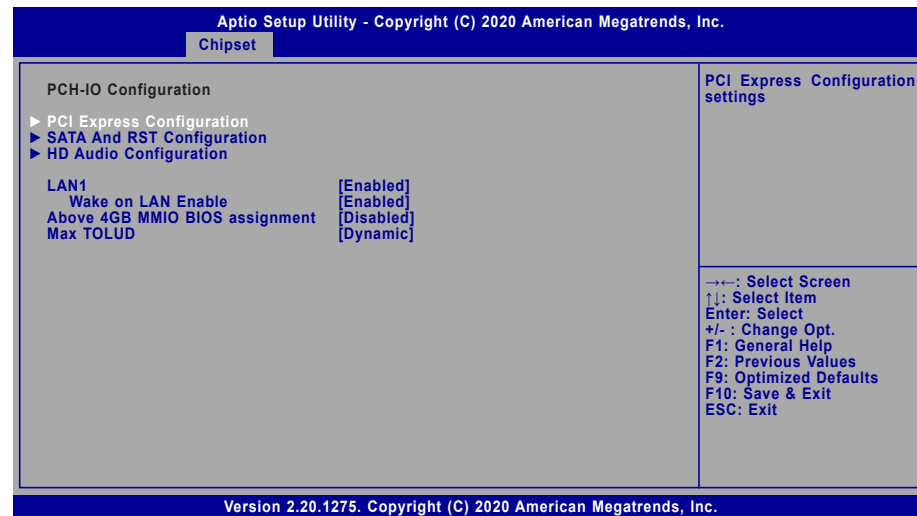

LAN1

Enable or disable onboard NIC.

Wake on LAN Enable

Enable or disable integrated LAN to wake the system.

Above 4GB MMIO BIOS assignment

Enable/Disable above 4GB MemoryMappedIO BIOS assignment. This is enabled automatically when Aperture Size is set to 2048MB.

Max TOLUD

Assign the maximum value of Top Of Lower Usable DRAM (TOLUD). Select to specify a fixed value, or select "Dynamic" so that the assignment would adjust TOLUD automatically based on largest MMIO length of installed graphic controller.

 **Note:**
The sub-menus are detailed in following sections.

▶ Chipset ▶ PCH-IO Configuration

PCI Express Configuration

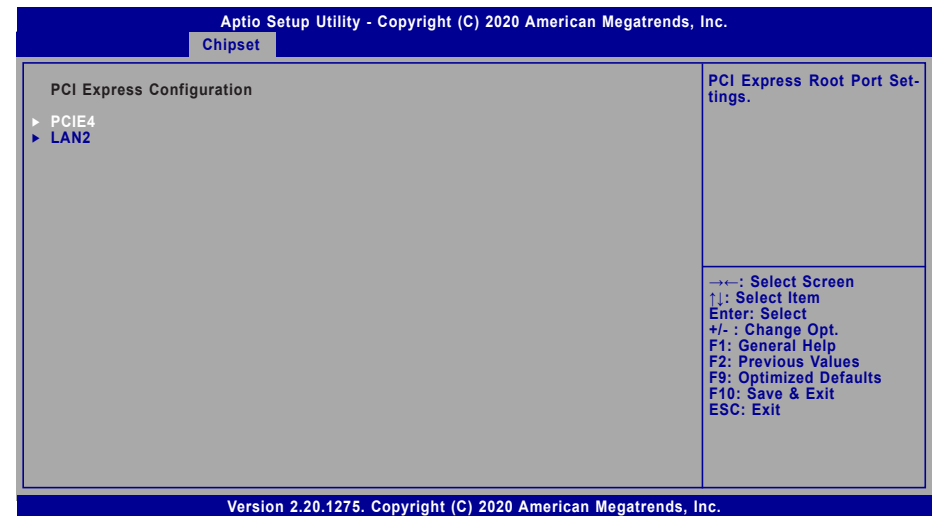

Select one of the PCI Express channels and press enter to configure the following settings.

PCIE4/LAN2

Enable or disable the PCI Express Root Port. The following fields are only available when the PCIe root port is enabled.

PCIe Speed

Select PCIe Speed of the current port — AUTO, Gen1, Gen 2, or Gen3. This field may not appear when the speed of the port is not configurable.

Hot Plug

Enable or disable hot plug function of the port. This field may not appear when the port does not support hot plug.

Detect Non-Compliance Device

Enable or disable this field to detect non-compliance PCIe devices in the PEG. This field may not appear when the port does not support Non-compliant device detection.

SATA And RST Configuration

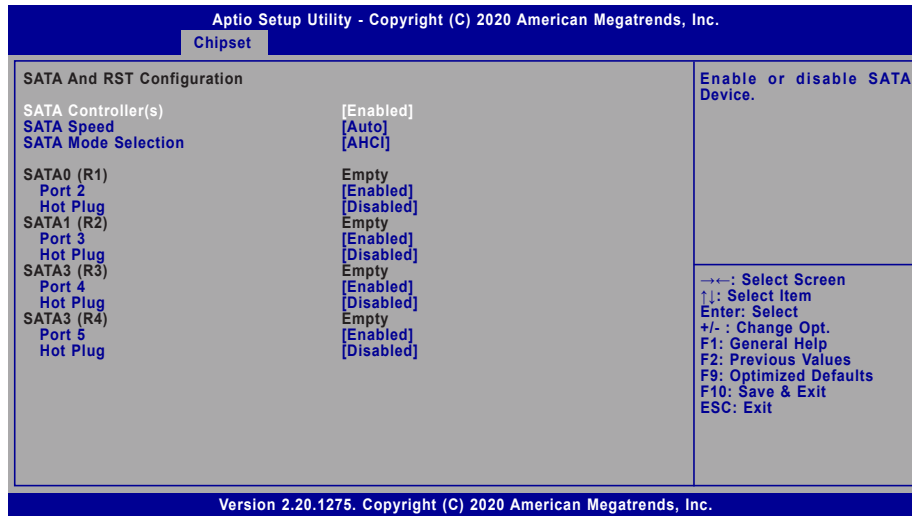

SATA Controller(s)

This field is used to enable or disable the Serial ATA controller.

SATA Speed

This field is used to select SATA speed generation limit: Auto, Gen1, Gen2 or Gen3.

SATA Mode Selection

The mode selection determines how the SATA controller(s) operates.

AHCI This option allows the Serial ATA controller(s) to use AHCI (Advanced Host Controller Interface).

Intel RST Premium With Intel Optane System Acceleration This option allows you to create RAID(if supported) or Intel Rapid Storage configuration along with Intel® Optane™ system acceleration on Serial ATA devices.

Use RST Legacy OROM

This field shows up when SATA Mode Selection is set to Intel RST Premium With Intel Optane System Acceleration. Enable or disable to use RST Legacy OROM when CSM is enabled.

Ports and Hot Plug

Enable or disable the Serial ATA port and its hot plug function.

HD Audio Configuration

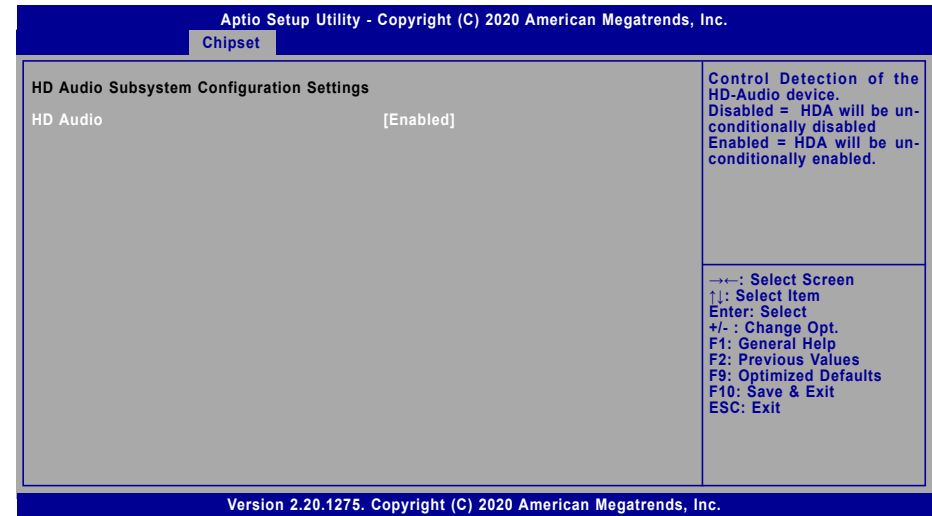

HD Audio

Control the detection of the HD Audio device.

Disabled HDA will be unconditionally disabled.

Enabled HDA will be unconditionally enabled.

► Security

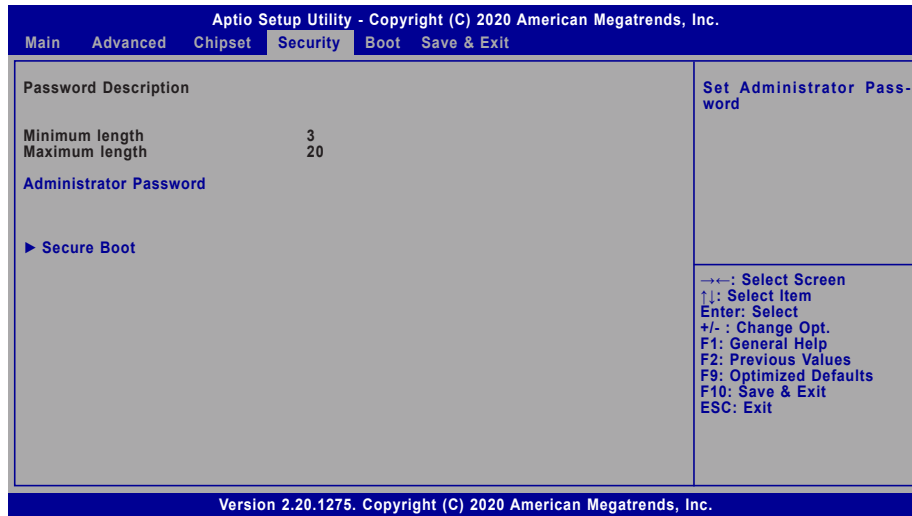

Administrator Password

Set the administrator password. To clear the password, input nothing and press enter when a new password is asked. Administrator Password will be required when entering the BIOS.

► Security

Secure Boot

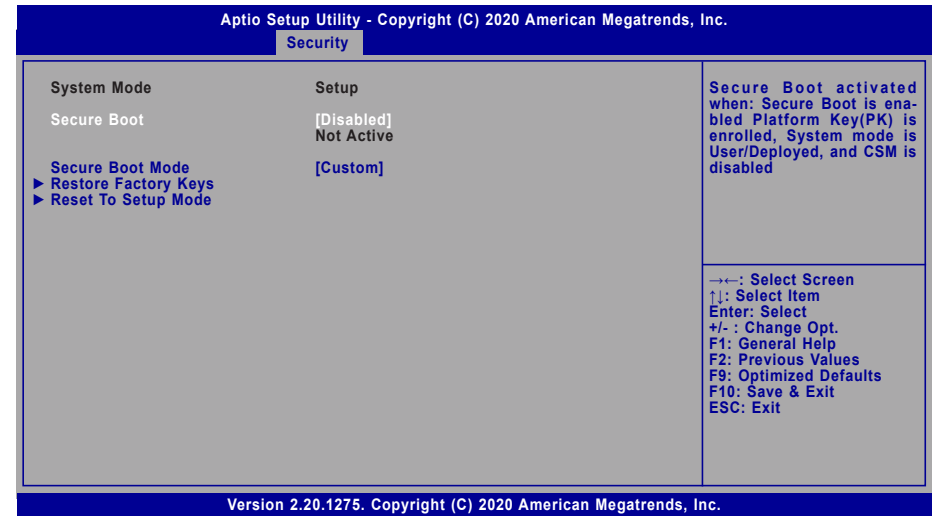

Secure Boot

The Secure Boot store a database of certificates in the firmware and only allows the Oses with authorized signatures to boot on the system. To activate Secure Boot, please make sure that "Secure Boot" is "[Enabled]", Platform Key (PK) is enrolled, "System Mode" is "User", and CSM is disabled. After enabling/disabling Secure Boot, please save the configuration and restart the system. When configured and activated correctly, the Secure Boot status will be "Active".

Secure Boot Customization

Select the secure boot mode – Standard or Custom. When set to Custom, the following fields will be configurable for the user to manually modify the key database.

Restore Factory Keys

Force system to User Mode. Load OEM-defined factory defaults of keys and databases onto the Secure Boot. Press Enter and a prompt will show up for you to confirm.

Reset To Setup Mode

Clear the database from the NVRAM, including all the keys and signatures installed in the Key Management menu. Press Enter and a prompt will show up for you to confirm.

► **Boot**

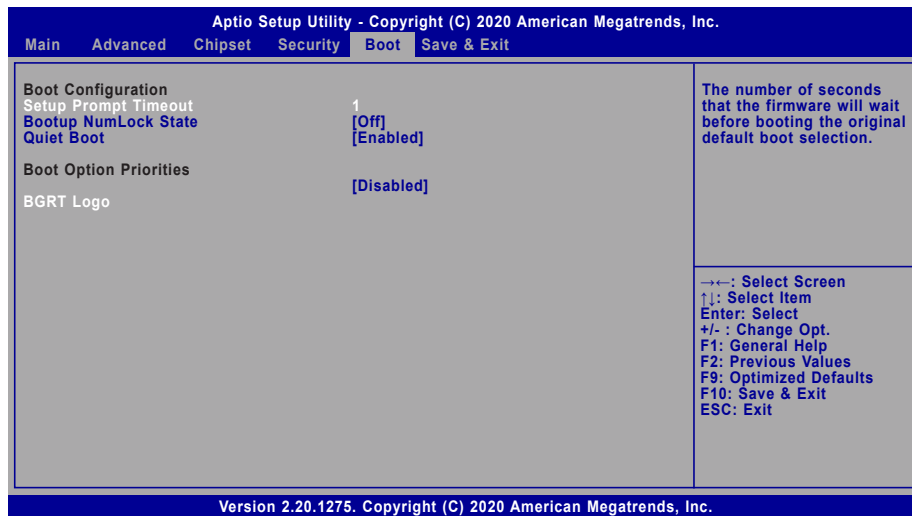

Setup Prompt Timeout

Set the number of seconds to wait for the setup activation key. 65535 (0xFFFF) denotes indefinite waiting.

Bootup NumLock State

Select the keyboard NumLock state: On or Off.

Quiet Boot

This section is used to enable or disable quiet boot option.

Boot Option Priorities

Rearrange the system boot order of available boot devices.

BGRT Logo

It is used to enable or disable to support display logo with ACPI BGRT table.

Note: If “Boot option filter” of “CSM Configuration” is set to “UEFI and Legacy” or “UEFI only”, and “Quiet Boot” is set to enabled, “BGRT Logo” will show up for configuration. Refer to the Advanced > CSM Configuration submenu for more information.

► **Save & Exit**

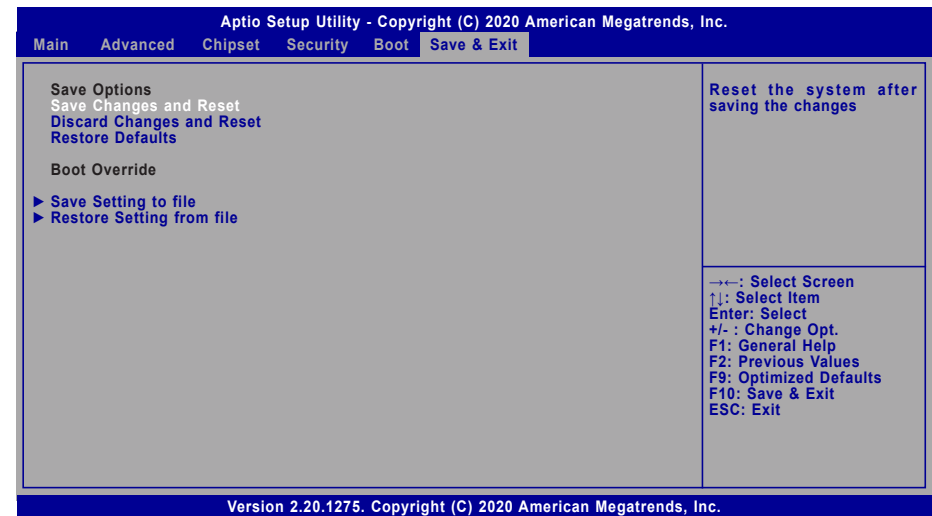

Save Changes and Reset

To save the changes, select this field and then press <Enter>. A dialog box will appear. Select Yes to reset the system after saving all changes made.

Discard Changes and Reset

To discard the changes, select this field and then press <Enter>. A dialog box will appear. Select Yes to reset the system setup without saving any changes.

Restore Defaults

To restore and load the optimized default values, select this field and then press <Enter>. A dialog box will appear. Select Yes to restore the default values of all the setup options.

Boot Override

Move the cursor to an available boot device and press Enter, and then the system will immediately boot from the selected boot device. The Boot Override function will only be effective for the current boot. The “Boot Option Priorities” configured in the Boot menu will not be changed.

► **Save Setting to file**

Select this option to save BIOS configuration settings to a USB flash device.

► **Restore Setting from file**

This field will appear only when a USB flash device is detected. Select this field to restore setting from the USB flash device.

► Updating the BIOS

To update the BIOS, you will need the new BIOS file and a flash utility. Please contact technical support or your sales representative for the files and specific instructions about how to update BIOS with the flash utility. For updating AMI BIOS in UEFI mode, you may refer to the how-to video at <https://www.dfi.com/Knowledge/Video/5>.

► Notice: BIOS SPI ROM

1. The Intel® Management Engine has already been integrated into this system board. Due to the safety concerns, the BIOS (SPI ROM) chip cannot be removed from this system board and used on another system board of the same model.
2. The BIOS (SPI ROM) on this system board must be the original equipment from the factory and cannot be used to replace one which has been utilized on other system boards.
3. If you do not follow the methods above, the Intel® Management Engine will not be updated and will cease to be effective.



Note:

- a. You can take advantage of flash tools to update the default configuration of the BIOS (SPI ROM) to the latest version anytime.
- b. When the BIOS IC needs to be replaced, you have to populate it properly onto the system board after the EEPROM programmer has been burned and follow the technical person's instructions to confirm that the MAC address should be burned or not.