

## EC70A-SU Installation Guide

### Package Contents

• 1 EC70A-SU system unit
• Mounting screws for SATA drive
• Mounting screws for Mini PCIe module
• 1 Quick Installation Guide
• 1 CD disk includes:
- Drivers / Manual

### Panel

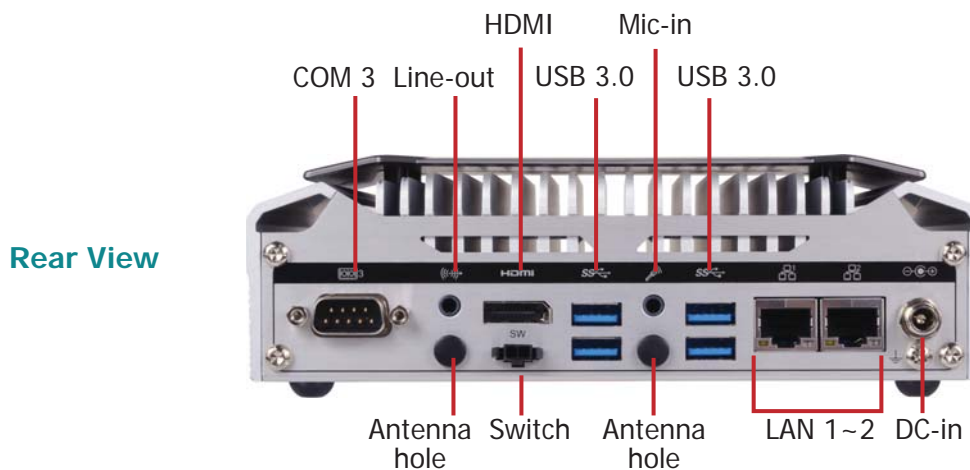
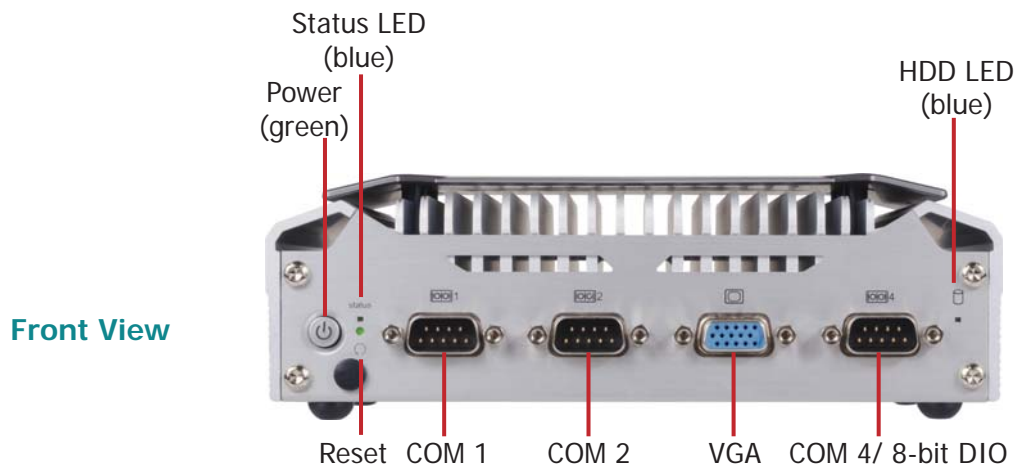

# Installing a 2.5" SATA Drive

1. Remove the two screws securing the chassis cover and lift the cover to open the system.



2. Locate the SATA drive bay on the system board. Remove 4 mounting screws that secure the drive bay to the system board.

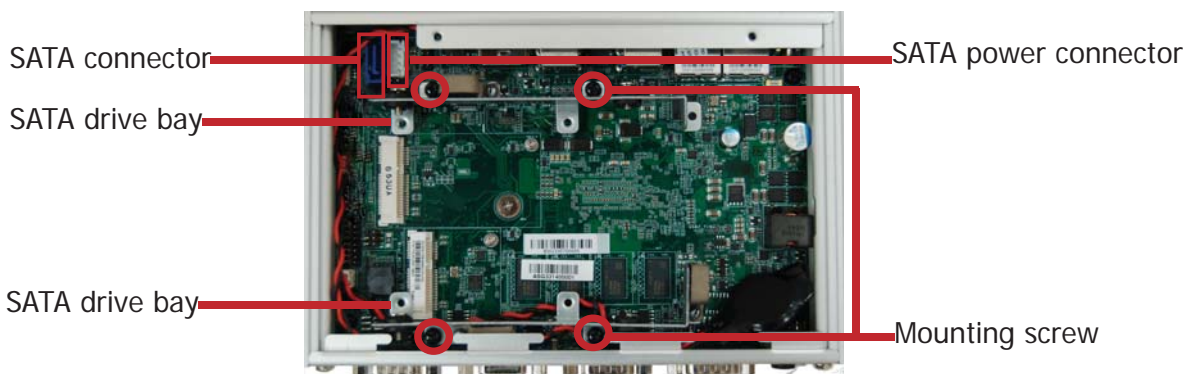

3. Align the mounting holes of a SATA drive with the mounting holes on the drive bay and connect the SATA cable (data and power) to the 2.5" SATA drive. Then, use the provided HDD mounting screws to affix the HDD to the drive bay.



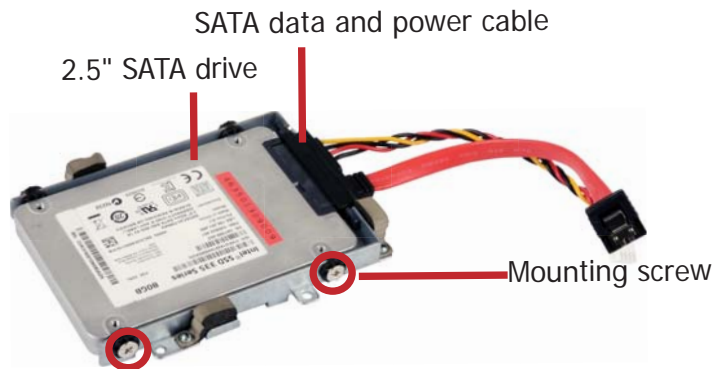

- Place the SATA with the attached drive bay to the system and connect the SATA cable to the SATA connectors on the system board.

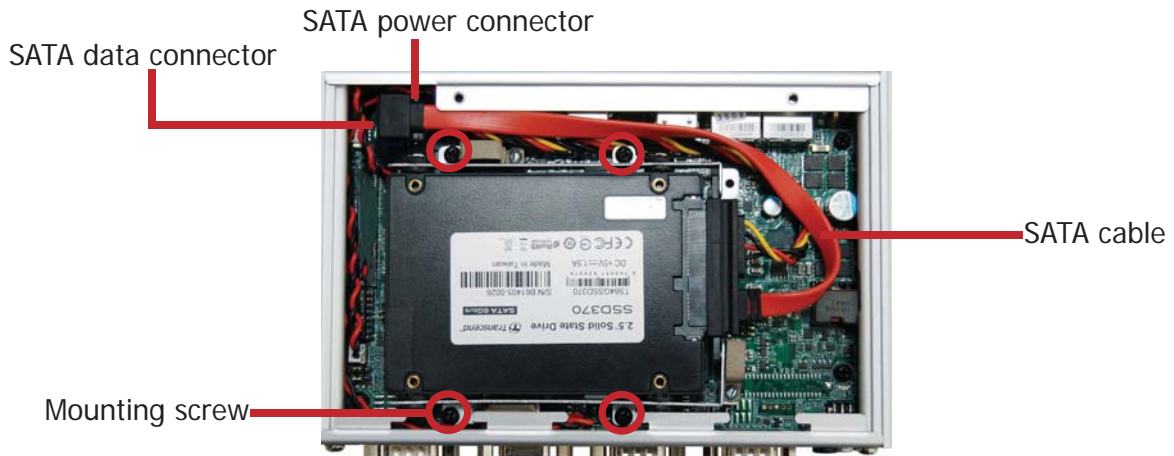

- Secure the SATA drive bay with the mounting screws you removed in step 1.

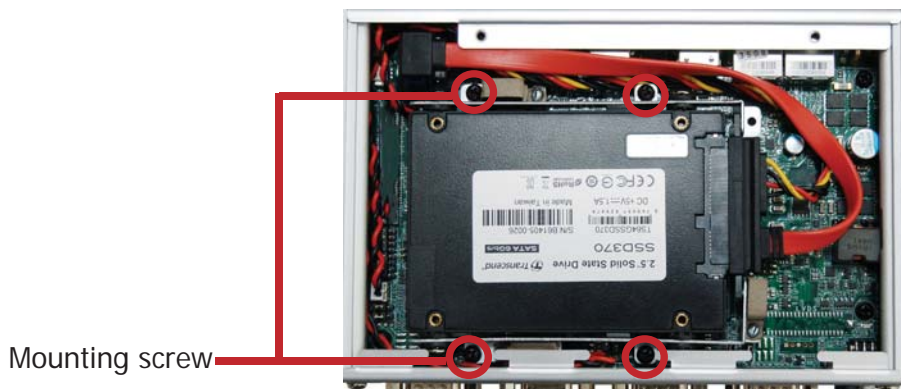

## Installing a Mini PCIe Card

The system board is equipped with 2 Mini PCIe slots: one full-size and one half-size slot. Here we will demonstrate the installation of a full-size Mini PCIe card.

1. Grasp the Mini PCIe card by its edges and align the notch in the connector of the PCIe card with the notch in the connector on the system board.

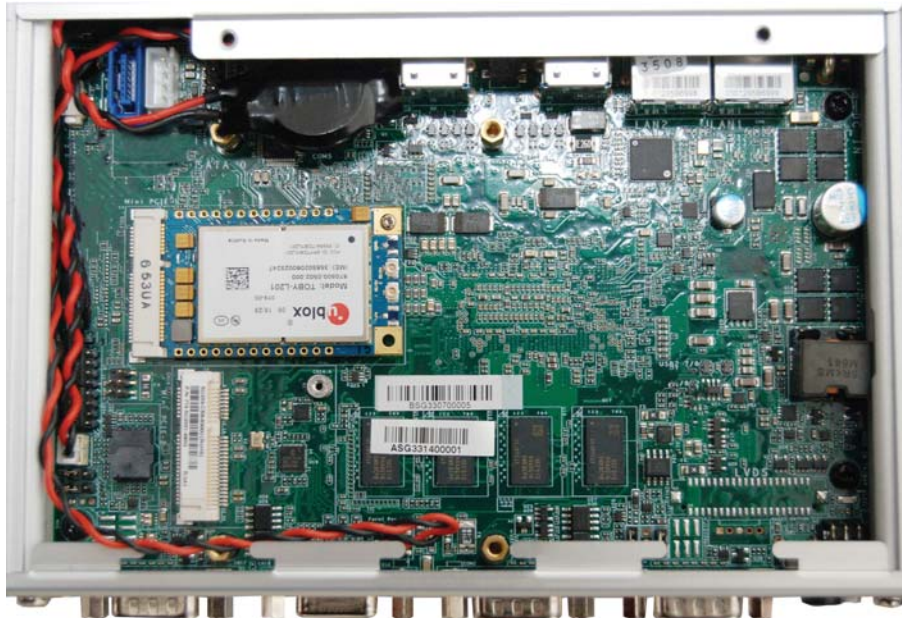

2. Push the Mini PCIe card down and use the provided mounting screw to secure the card on the system board.

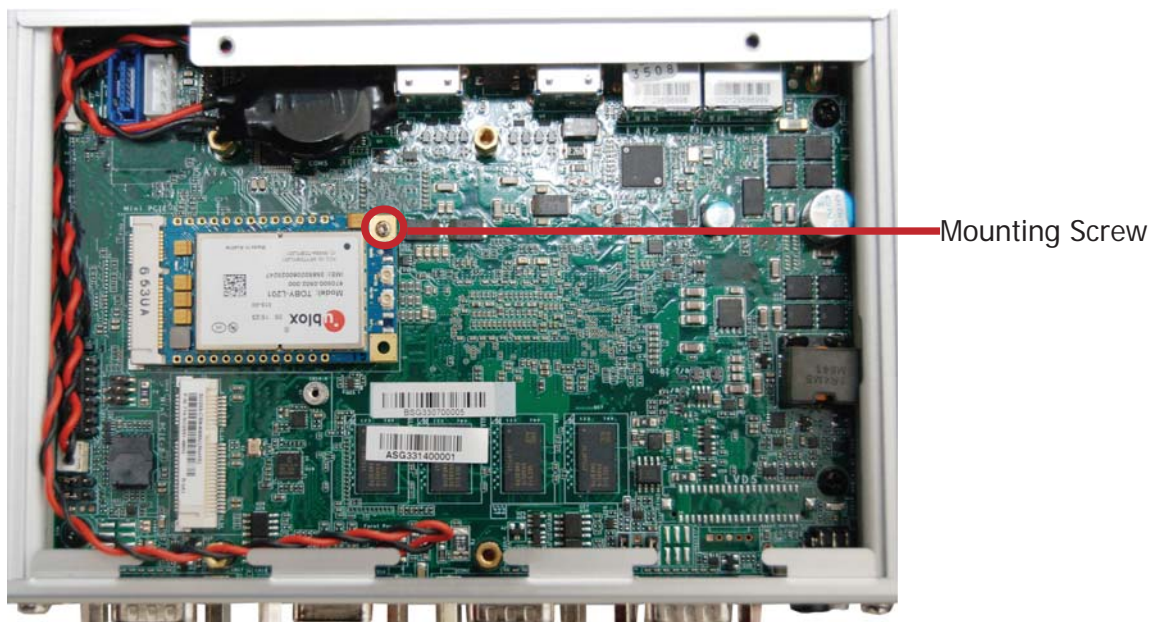

**Note:**

The system also has a half-size Mini PCIe slot that can accommodate either a Mini PCIe or an mSATA card. Refer to jumper settings for signal selection for this slot.

# Board Layout and Jumper Settings

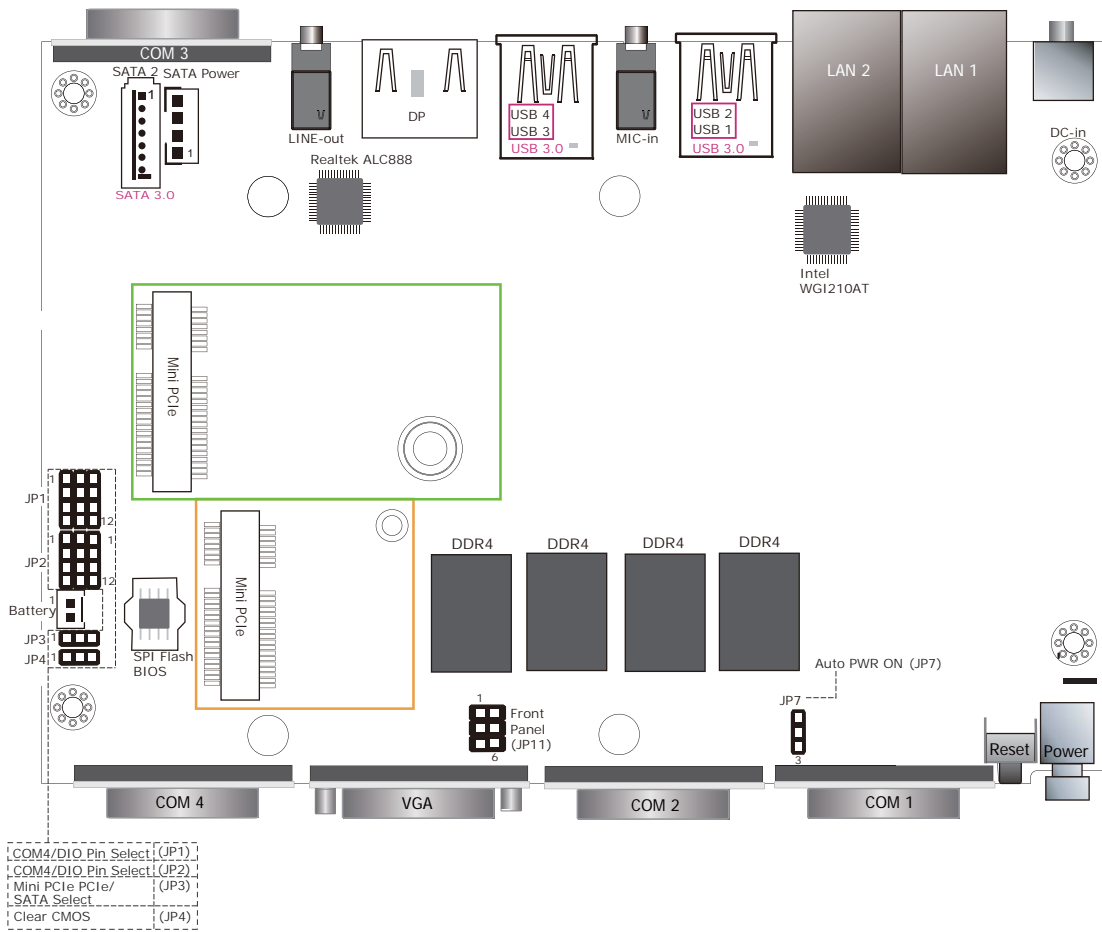

COM4 / DIO Pin Select	JP1
COM4	1-2, 4-5, 7-8, 10-11 On
DIO	2-3, 5-6, 8-9, 11-12 On

Clear CMOS	JP4
Normal	1-2 On
Clear CMOS	2-3 On

COM4 / DIO Pin Select	JP2
COM4	1-2, 4-5, 7-8, 10-11 On
DIO	2-3, 5-6, 8-9, 11-12 On

Auto PWR ON	JP7
Normal	1-2 On
Auto-PWR ON	2-3 On

Mini PCIe/PCIe/SATA Select	JP3
PCIe	2-3 On
SATA	1-2 On

**Note:**  
You cannot use COM 4 and DIO at the same time. Please set JP1 and JP2 together.