



# ADS630-R680E/Q670E

ATX Industrial Motherboard  
User's Manual

---

## Copyright

This publication contains information that is protected by copyright. No part of it may be reproduced in any form or by any means or used to make any transformation/adaptation without the prior written permission from the copyright holders.

This publication is provided for informational purposes only. The manufacturer makes no representations or warranties with respect to the contents or use of this manual and specifically disclaims any express or implied warranties of merchantability or fitness for any particular purpose. The user will assume the entire risk of the use or the results of the use of this document. Further, the manufacturer reserves the right to revise this publication and make changes to its contents at any time, without obligation to notify any person or entity of such revisions or changes.

Changes after the publication's first release will be based on the product's revision. The website will always provide the most updated information.

© 2022. All Rights Reserved.

## Trademarks

Product names or trademarks appearing in this manual are for identification purpose only and are the properties of the respective owners.

## FCC and DOC Statement on Class B

This equipment has been tested and found to comply with the limits for a Class B digital device, pursuant to Part 15 of the FCC rules. These limits are designed to provide reasonable protection against harmful interference when the equipment is operated in a residential installation. This equipment generates, uses and can radiate radio frequency energy and, if not installed and used in accordance with the instruction manual, may cause harmful interference to radio communications. However, there is no guarantee that interference will not occur in a particular installation. If this equipment does cause harmful interference to radio or television reception, which can be determined by turning the equipment off and on, the user is encouraged to try to correct the interference by one or more of the following measures:

- Reorient or relocate the receiving antenna.
- Increase the separation between the equipment and the receiver.
- Connect the equipment into an outlet on a circuit different from that to which the receiver is connected.
- Consult the dealer or an experienced radio TV technician for help.

## Notice:

1. The changes or modifications not expressly approved by the party responsible for compliance could void the user's authority to operate the equipment.
2. Shielded interface cables must be used in order to comply with the emission limits.

# Table of Contents

<b>Chapter 1 - Introduction</b> .....	<b>6</b>
Specifications .....	6
Features .....	8
Block Diagram .....	9
<b>Chapter 2 - Hardware Installation</b> .....	<b>10</b>
Board Layout.....	10
System Memory .....	11
Installing the DIMM Module .....	11
Removing the DIMM Module.....	12
CPU.....	13
Installing the CPU Fan and Heat Sink.....	13
Jumper Settings .....	14
CLEAR CMOS Data .....	14
DIO Power & Voltage - JP28/29/30 .....	15
AT/ATX Mode - JP26.....	15
PS/2 and USB Wake up select - JP25 .....	16
M.2 Connector Power Control - JP31/32/33 .....	17
Power Selection for COM1/COM2-TSJP1/TSJP5 .....	17
Selection for COM1 / COM2 - TSJP2,3,4 / TSJP6,7,8 .....	18
Rear I/O Ports.....	19
USB Ports.....	20
Graphics Interfaces .....	21
LAN Ports.....	22
Audio .....	22
Internal I/O Connectors .....	23
SATA (Serial ATA) .....	23
Digital I/O Connector, DIO Power .....	23
COM (Serial) ports.....	24
Cooling Fan Connectors.....	25
Power Connector .....	25
Front Panel .....	26
S/PDIF Connector.....	26
COM1 .....	27
COM2.....	27
Front Audio.....	28
Front LAN LED .....	28
PS/2 .....	29
USB 3.2 Gen2 Key B .....	29
USB 2.0 .....	30
USB 2.0 .....	30
Expansion Slots .....	31
Installing the M.2 Module .....	31
Battery .....	32
<b>Chapter 3 - BIOS Settings</b> .....	<b>33</b>
Overview .....	33
Main.....	34
Advanced .....	34
CPU Configuration.....	35
Power & Performance .....	35
PCH-FW Configuration .....	36
Trusted Computing.....	37
NCT6126D Super IO Configuration .....	38
NCT6126D HW Monitor .....	39

Serial Port Console Redirection .....	40
ACPI Configuration .....	41
USB Configuration .....	42
Network Stack Configuration.....	43
DFI WDT Configuration.....	43
USB Power Control .....	44
Chipset .....	45
SATA And RST Configuration .....	47
Security .....	48
Secure Boot.....	48
Boot .....	49
Save & Exit .....	49
Updating the BIOS .....	50
Notice: BIOS SPI ROM.....	50
<b>Chapter 4 - RAID Settings</b> .....	<b>51</b>
RAID Levels.....	51
Setup Procedure.....	51
How to enable Intel(R) Rapid Storage Technology in BIOS.....	52

## About this Manual

This manual can be downloaded from the website.

The manual is subject to change and update without notice, and may be based on editions that do not resemble your actual products. Please visit our website or contact our sales representatives for the latest editions.

## Warranty

1. Warranty does not cover damages or failures that occur from misuse of the product, inability to use the product, unauthorized replacement or alteration of components and product specifications.
2. The warranty is void if the product has been subjected to physical abuse, improper installation, modification, accidents or unauthorized repair of the product.
3. Unless otherwise instructed in this user's manual, the user may not, under any circumstances, attempt to perform service, adjustments or repairs on the product, whether in or out of warranty. It must be returned to the purchase point, factory or authorized service agency for all such work.
4. We will not be liable for any indirect, special, incidental or consequential damages to the product that has been modified or altered.

## Static Electricity Precautions

It is quite easy to inadvertently damage your PC, system board, components or devices even before installing them in your system unit. Static electrical discharge can damage computer components without causing any signs of physical damage. You must take extra care in handling them to ensure against electrostatic build-up.

1. To prevent electrostatic build-up, leave the system board in its anti-static bag until you are ready to install it.
2. Wear an antistatic wrist strap.
3. Do all preparation work on a static-free surface.
4. Hold the device only by its edges. Be careful not to touch any of the components, contacts or connections.
5. Avoid touching the pins or contacts on all modules and connectors. Hold modules or connectors by their ends.



### Important:

Electrostatic discharge (ESD) can damage your processor, disk drive and other components. Perform the upgrade instruction procedures described at an ESD workstation only. If such a station is not available, you can provide some ESD protection by wearing an antistatic wrist strap and attaching it to a metal part of the system chassis. If a wrist strap is unavailable, establish and maintain contact with the system chassis throughout any procedures requiring ESD protection.

## Safety Measures

- To avoid damage to the system, use the correct AC input voltage range.
- To reduce the risk of electric shock, unplug the power cord before removing the system chassis cover for installation or servicing. After installation or servicing, cover the system chassis before plugging the power cord.

## About the Package

The package contains the following items. If any of these items are missing or damaged, please contact your dealer or sales representative for assistance.

- 1 ADS630 motherboard
- 1 COM port cable (Length: 300mm, 2 x COM ports)
- 1 Serial ATA data cable (Length: 500mm)
- 1 I/O shield (4 LAN)
- 1 I/O shield (2 LAN)
- 1 M.2 screw/standoff

The board and accessories in the package may not come similar to the information listed above. This may differ in accordance with the sales region or models in which it was sold. For more information about the standard package in your region, please contact your dealer or sales representative.

## Before Using the System Board

When installing the system board in a new system, you will need at least the following internal components.

- Memory module
- Storage device such as a hard disk drive.
- Power supply

External system peripherals may also be required for navigation and display, including at least a keyboard, a mouse and a video display monitor.

► **Specifications**

Model Name	ADS630-R680E		ADS630-Q670E	
<b>SYSTEM</b>	<b>Processor</b>	Intel® Bartlett Lake-S Hybrid LGA 1700 Socket Processors Intel® Core™ 7 251E (24 Cores, 36M Cache, up to 5.6 GHz); 65W Intel® Core™ 7 251TE (24 Cores, 36M Cache, up to 5.4 GHz); 45W Intel® Core™ 5 221E (14 Cores, 24M Cache, up to 5.2 GHz); 65W Intel® Core™ 5 221TE (14 Cores, 24M Cache, up to 5.0 GHz); 45W Intel® Core™ 5 211E (10 Cores, 20M Cache, up to 4.9 GHz); 65W Intel® Core™ 5 211TE (10 Cores, 20M Cache, up to 4.8 GHz); 45W Intel® Core™ 3 201E (4 Cores, 12M Cache, up to 4.8 GHz); 60W Intel® Core™ 3 201TE (4 Cores, 12M Cache, up to 4.6 GHz); 45W Intel® 300 (2 Cores, 6M Cache, up to 3.9 GHz); 45W Intel® 300T (2 Cores, 6M Cache, up to 3.4 GHz); 35W 14th Generation Intel® LGA 1700 Socket Processors, TDP support up to 125W Intel® Core™ i9-14901E (8 Cores, 36M Cache, up to 5.6 GHz); 65W Intel® Core™ i5-14401E (6 Cores, 24M Cache, up to 4.7 GHz); 65W Intel® Core™ i9-14900 (24 Cores, 36M Cache, up to 5.8 GHz); 65W Intel® Core™ i9-14900T (24 Cores, 36M Cache, up to 5.5 GHz); 35W Intel® Core™ i7-14700 (20 Cores, 33M Cache, up to 5.4 GHz); 65W Intel® Core™ i7-14700T (20 Cores, 33M Cache, up to 5.2 GHz); 35W Intel® Core™ i5-14500 (14 Cores, 24M Cache, up to 5 GHz); 65W Intel® Core™ i5-14500T (14 Cores, 24M Cache, up to 4.8 GHz); 35W Intel® Core™ i5-14400 (10 Cores, 20M Cache, up to 4.7 GHz); 65W Intel® Core™ i5-14400T (10 Cores, 20M Cache, up to 4.5 GHz); 35W Intel® Core™ i3-14100 (4 Cores, 12M Cache, up to 4.7 GHz); 60W Intel® Core™ i3-14100T (4 Cores, 12M Cache, up to 4.4 GHz); 35W Intel® 300 (2 Cores, 6M Cache, up to 3.9 GHz); 46W Intel® 300T (2 Cores, 6M Cache, up to 3.4 GHz); 35W 13th Generation Intel® LGA 1700 Socket Processors, TDP support up to 125W Intel® Core™ i9-13900E (24 Cores, 36M Cache, up to 5.2 GHz); 65W Intel® Core™ i9-13900TE (24 Cores, 36M Cache, up to 5.0 GHz); 35W Intel® Core™ i7-13700E (16 Cores, 30M Cache, up to 5.1 GHz); 65W Intel® Core™ i7-13700TE (16 Cores, 30M Cache, up to 4.8 GHz); 35W Intel® Core™ i7-13700T (16 Cores, 30M Cache, up to 4.9 GHz); 35W Intel® Core™ i5-13500E (14 Cores, 24M Cache, up to 4.6 GHz); 65W Intel® Core™ i5-13500TE (14 Cores, 24M Cache, up to 4.5 GHz); 35W Intel® Core™ i5-13500T (14 Cores, 24M Cache, up to 4.6 GHz); 35W Intel® Core™ i5-13400E (10 Cores, 20M Cache, up to 4.6 GHz); 65W Intel® Core™ i3-13100E (4 Cores, 12M Cache, up to 4.4 GHz); 65W Intel® Core™ i3-13100TE (4 Cores, 12M Cache, up to 4.1 GHz); 35W Intel® Core™ i3-13100T (4 Cores, 12M Cache, up to 4.2 GHz); 35W 12th Generation Intel® LGA 1700 Socket Processors, TDP support up to 125W Intel® Core™ i9-12900E (16 Cores, 30M Cache, up to 5.0 GHz); 65W Intel® Core™ i9-12900TE (16 Cores, 30M Cache, up to 4.8 GHz); 35W Intel® Core™ i7-12700E (12 Cores, 25M Cache, up to 4.8 GHz); 65W Intel® Core™ i7-12700TE (12 Cores, 25M Cache, up to 4.6 GHz); 35W Intel® Core™ i5-12500E (6 Cores, 18M Cache, up to 4.5 GHz); 65W Intel® Core™ i5-12500TE (6 Cores, 18M Cache, up to 4.3 GHz); 35W Intel® Core™ i3-12100E (4 Cores, 12M Cache, up to 4.2 GHz); 60W Intel® Core™ i3-12100TE (4 Cores, 12M Cache, up to 4.0 GHz); 35W Intel® Pentium® G7400E (2 Cores, 6M Cache, 3.6 GHz); 46W Intel® Pentium® G7400TE (2 Cores, 6M Cache, 3.0 GHz); 35W Intel® Celeron® G6900E (2 Cores, 4M Cache, 3.0 GHz); 46W Intel® Celeron® G6900TE (2 Cores, 4M Cache, 2.4 GHz); 35W		
	<b>Chipset</b>	Intel® R680E Chipset	Intel® Q670E Chipset	
	<b>Memory</b>	Four 288-pin UDIMM up to 128GB Dual Channel DDR4 3200 MHz (ECC/Non-ECC)	Four 288-pin UDIMM up to 128GB Dual Channel DDR4 3200 MHz (Non-ECC)	
	<b>BIOS</b>	AMI SPI 256Mbit		
<b>GRAPHICS</b>	<b>Controller</b>	Intel® UHD Graphics 700 series		
	<b>Feature</b>	OpenGL 4.5, DirectX 12, OpenCL 2.1 <b>HW Decode:</b> AVC/H.264, MPEG2, VC1/WMV9, JPEG/MJPEG, HEVC/H265, VP8, VP9 <b>HW Encode:</b> MPEG2, AVC/H264, JPEG, HEVC/H265, VP8, VP9		
	<b>Display</b>	1 x VGA 2 x DP++ 1 x HDMI 2.0a <b>VGA:</b> resolution up to 1920x1200 @ 60Hz <b>DP++:</b> resolution up to 4096x2304 @60Hz <b>HDMI:</b> resolution up to 4096x2160 @ 24Hz		
	<b>Quad Displays</b>	VGA + 2 x DP++ + HDMI		

Model Name		ADS630-R680E	ADS630-Q670E
EXPANSION	Interface	1 x PCIe x16 (Gen 5) - Support PCIe1 : Riser card x16 or x8/x8 selected by BOM change 4 x PCIe x4 (Gen 4) 2 x PCI 1 x M.2 2230 E key (PCIe/USB 2.0/Intel CNVi/Wifi 6E as option, MOQ required) 1 x M.2 2242/2260/2280 M key (PCIe x4 NVMe share with PCIe x4 slot#2 as optional, MOQ required) 1 x M.2 2242/2260/2280 M key (PCIe x4 Gen3 NVMe/Intel Optane Memory support)	1 x PCIe x16 (Gen 5) - Support PCIe1 : Riser card x16 or x8/x8 selected by BOM change 4 x PCIe x4 (Gen 4) 2 x PCI 1 x M.2 2230 E key (PCIe/USB 2.0/Intel CNVi/Wifi 6E as option, MOQ required) 1 x M.2 2242/2260/2280 M key (PCIe x4 NVMe share with PCIe x4 slot#2 as optional, MOQ required) 1 x M.2 2242/2260/2280 M key (PCIe x4 Gen3 NVMe/Intel Optane Memory support)
	AUDIO	Audio Codec	Realtek ALC888
ETHERNET	Controller	1 x Intel® I226-LM PCIe (10M/100M/1000Mbps/2.5G) (only Xeon, Core i9/i7/i5 support iAMT) 1 x Intel® I226-V PCIe (10M/100M/1000Mbps/2.5G) 2 x Intel® E610-XAT2 (10 GBASE-T/1 GbE/100 Mbps) (no support WOL)	1 x Intel® I226-LM PCIe (10M/100M/1000Mbps/2.5G) (only Xeon, Core i9/i7/i5 support iAMT) 1 x Intel® I226-V PCIe (10M/100M/1000Mbps/2.5G)
	REAR I/O	Ethernet	2 x 2.5GbE
REAR I/O	USB	4 x USB 3.2 Gen2 4 x USB 3.2 Gen1	4 x USB 3.2 Gen2 4 x USB 3.2 Gen1
	Display	1 x VGA 2 x DP++ 1 x HDMI 2.0a	1 x VGA 2 x DP++ 1 x HDMI 2.0a
	Audio	1 x Line-out 1 x Mic-in 1 x Line-in (opt. by request, MOQ required)	1 x Line-out 1 x Mic-in 1 x Line-in (opt. by request, MOQ required)
	INTERNAL I/O	Serial	2 x RS-232/422/485 (RS-232 w/ power) (2.54mm pitch) 4 x RS-232 (2.54mm pitch)
INTERNAL I/O	USB	2 x USB 3.2 Gen2 Key B box header 2 x USB 2.0 (2.54mm pitch, Colay vertical Type A, opt.: MOQ required) 1 x USB 2.0 Vertical Type A	2 x USB 3.2 Gen1 Key B box header 2 x USB 2.0 (2.54mm pitch, Colay vertical Type A, opt.: MOQ required) 1 x USB 2.0 Vertical Type A
	Audio	1 x Front Audio Header 1 x S/PDIF	1 x Front Audio Header 1 x S/PDIF
	SATA	4 x SATA 3.0 (up to 6Gb/s) RAID 0/1/5/10	4 x SATA 3.0 (up to 6Gb/s) RAID 0/1/5/10
	PS/2	1 x PS/2 (2.54mm pitch)	1 x PS/2 (2.54mm pitch)
	DIO	1 x 8-bit DIO	1 x 8-bit DIO
	SMBus	1 x SMBus	1 x SMBus
	WATCHDOG TIMER	Output & Interval	System Reset, Programmable via Software from 1 to 255 Seconds
SECURITY	TPM	Nuvoton TPM2.0	Nuvoton TPM2.0
POWER	Type	ATX	ATX
	Connector	8-pin ATX 12V power 24-pin ATX power	8-pin ATX 12V power 24-pin ATX power
	Consumption	Typical: i9-13900K: 3.3V @ 0.39A (1.29W); 5V @ 2.25A (11.25W); 12V @ 1.61A (19.32W) Max.: i9-13900K: 3.3V @ 1.31A (4.32W); 5V @ 4.46A (22.3W); 12V @ 28.55A (342.6W)	Typical: i9-13900K: 3.3V @ 0.39A (1.29W); 5V @ 2.25A (11.25W); 12V @ 1.61A (19.32W) Max.: i9-13900K: 3.3V @ 1.31A (4.32W); 5V @ 4.46A (22.3W); 12V @ 28.55A (342.6W)
OS SUPPORT	RTC Battery	CR2032 Coin Cell	CR2032 Coin Cell
	Microsoft	Windows 10 IoT Enterprise 64-bit Windows 11 LTSC	Windows 10 IoT Enterprise 64-bit Windows 11 LTSC
	Linux	Linux	Linux
ENVIRONMENT	Temperature	Operating: -5°C ~ 65°C Storage: -20°C ~ 70°C with RTC Battery; -40°C ~ 85°C without RTC Battery	Operating: -5°C ~ 65°C Storage: -20°C ~ 70°C with RTC Battery; -40°C ~ 85°C without RTC Battery
	Humidity	Operating: 5% ~ 95% RH Storage: 5% ~ 95% RH	Operating: 5% ~ 95% RH Storage: 5% ~ 95% RH
	MTBF	469,341 hrs @ 25°C; 259,388 hrs @ 45°C; 160,192 hrs @ 60°C; 115,630 hrs @ 70°C Calculation Model: Telcordia Issue 4 Environment: GB, GC - Ground Benign, Controlled	469,341 hrs @ 25°C; 259,388 hrs @ 45°C; 160,192 hrs @ 60°C; 115,630 hrs @ 70°C Calculation Model: Telcordia Issue 4 Environment: GB, GC - Ground Benign, Controlled

Model Name		ADS630-R680E	ADS630-Q670E
MECHANISM	Dimensions	ATX Form Factor 305mm (12") x 244mm (9.6")	ATX Form Factor 305mm (12") x 244mm (9.6")
	Height	PCB: 1.6mm Top Side: 33.3mm Bottom Side: 4mm	PCB: 1.6mm Top Side: 33.3mm Bottom Side: 4mm
CERTIFICATIONS	Certifications	CE, FCC Class B, UKCA, RoHS, UL	CE, FCC Class B, UKCA, RoHS, UL

## ► Features

---

### Watchdog Timer

The Watchdog Timer function allows your application to regularly “clear” the system at the set time interval. If the system hangs or fails to function, it will reset at the set time interval so that your system will continue to operate.

### DDR4

DDR4 delivers increased system bandwidth and improves performance. The advantages of DDR4 provide an extended battery life and improve the performance at a lower power than DDR3/DDR2.

### Serial ATA

Serial ATA is a storage interface that is compliant with SATA 1.0a specification. With speed of up to 6Gb/s (SATA 3.0), it improves hard drive performance faster than the standard parallel ATA whose data transfer rate is 100MB/s.

### Gigabit LAN

Two Intel® Gigabit LAN controllers support up to 2.5Gbps data transmission, Two Intel® 10G LAN controllers support up to 10Gbps data transmission

### Wake-On-LAN

This feature allows the network to remotely wake up a Soft Power Down (Soft-Off) PC. It is supported via the onboard LAN port or via a PCI LAN card that uses the PCI PME (Power Management Event) signal. However, if your system is in the Suspend mode, you can power-on the system only through an IRQ or DMA interrupt.

### Wake-On-USB

This function allows you to use a USB keyboard or USB mouse to wake up a system from the S3 (STR - Suspend To RAM) state.

### PCI Express

PCI Express is a high bandwidth I/O infrastructure that possesses the ability to scale speeds by forming multiple lanes. The x4 PCI Express lane supports transfer rate of 4 Gigabyte per second (2 directions). The PCI Express architecture also supports high performance graphics infrastructure by enhancing the capability of a PCIe x16 Gen 3 at 16GB/s bandwidth (8GB/s in each direction).

### ACPI STR

The system board is designed to meet the ACPI (Advanced Configuration and Power Interface) specification. ACPI has energy saving features that enables PCs to implement Power Management and Plug-and-Play with operating systems that support OS Direct Power Management. ACPI when enabled in the Power Management Setup will allow you to use the Suspend to RAM function.

With the Suspend to RAM function enabled, you can power-off the system at once by pressing the power button or selecting “Standby” when you shut down Windows® without having to go through the sometimes tiresome process of closing files, applications and operating system. This is because the system is capable of storing all programs and data files during the entire operating session into RAM (Random Access Memory) when it powers-off. The operating session will resume exactly where you left off the next time you power-on the system.

### Power Failure Recovery

When power returns after an AC power failure, you may choose to either power-on the system manually or let the system power-on automatically.

### USB

The system board supports the new USB 3.2 Gen 2. It is capable of running at a maximum transmission speed of up to 10 Gbit/s (1250 MB/s), and is faster than USB 2.0 (480 Mbit/s, or 60 MB/s) and USB 1.1 (12Mb/s). USB 3.2 reduces the time required for data transmission, reduces power consumption, and is backward compatible with USB 2.0. It is a marked improvement in device transfer speeds between your computer and a wide range of simultaneously accessible external Plug and Play peripherals.

### RTC Timer

The Real Time Clock (RTC) installed on the system board allows your system to automatically power-on on the set date and time.

► Block Diagram

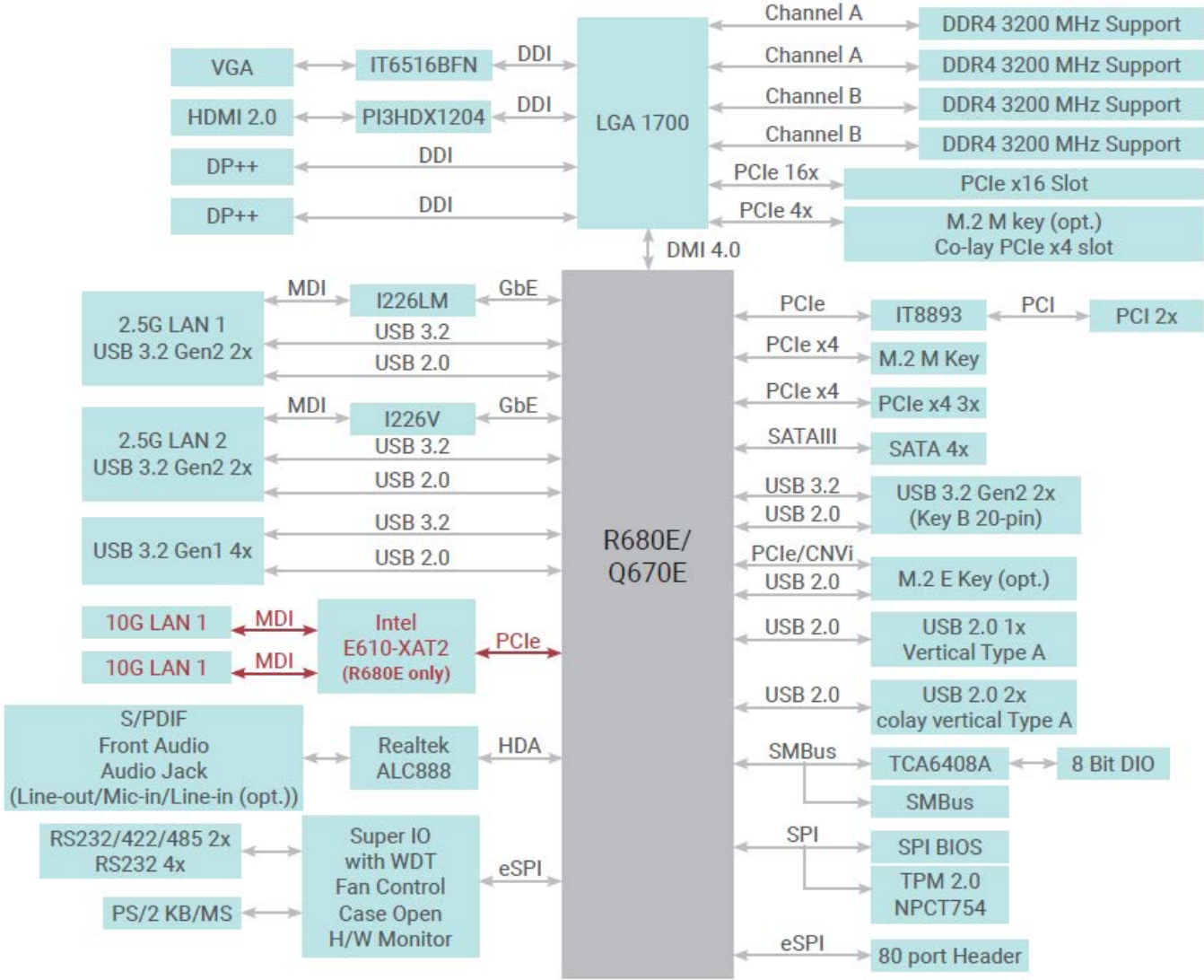

# Chapter 2 - Hardware Installation

## ▶ Board Layout

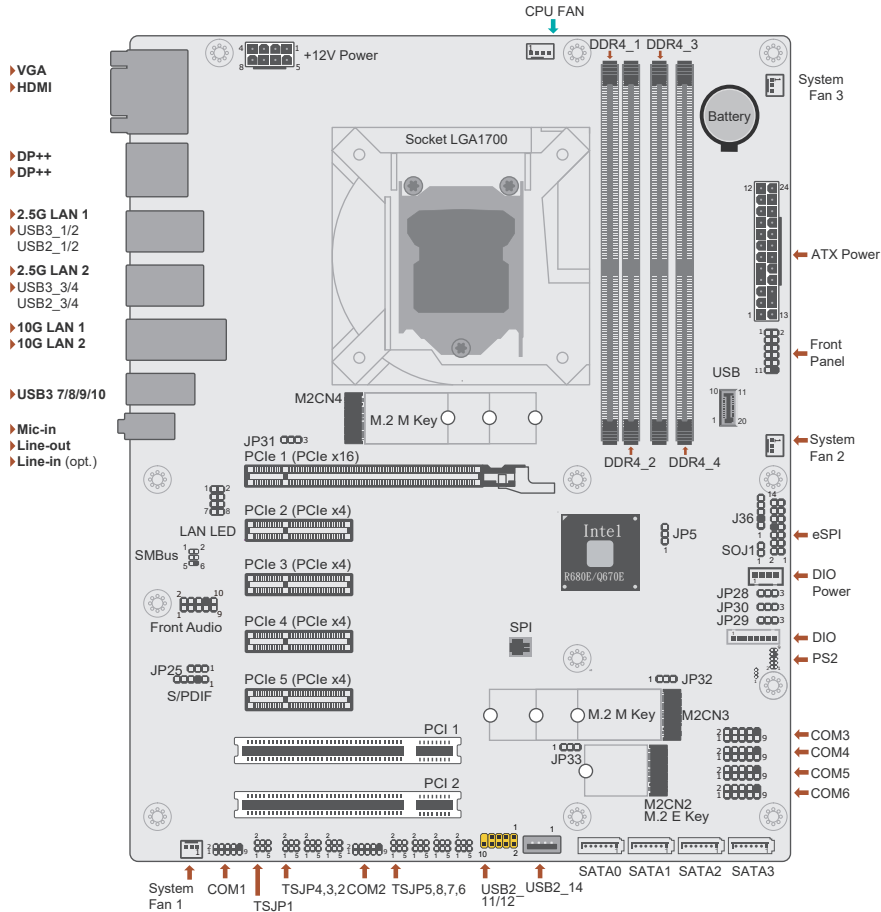

**Note:** Some components are optional and only available upon request.



**Important:** Electrostatic discharge (ESD) can damage your board, processor, disk drives, add-in boards, and other components. Perform installation procedures at an ESD workstation only. If such a station is not available, you can provide some ESD protection by wearing an antistatic wrist strap and attaching it to a metal part of the system chassis. If a wrist strap is unavailable, establish and maintain contact with the system chassis throughout any procedures requiring ESD protection.

► System Memory

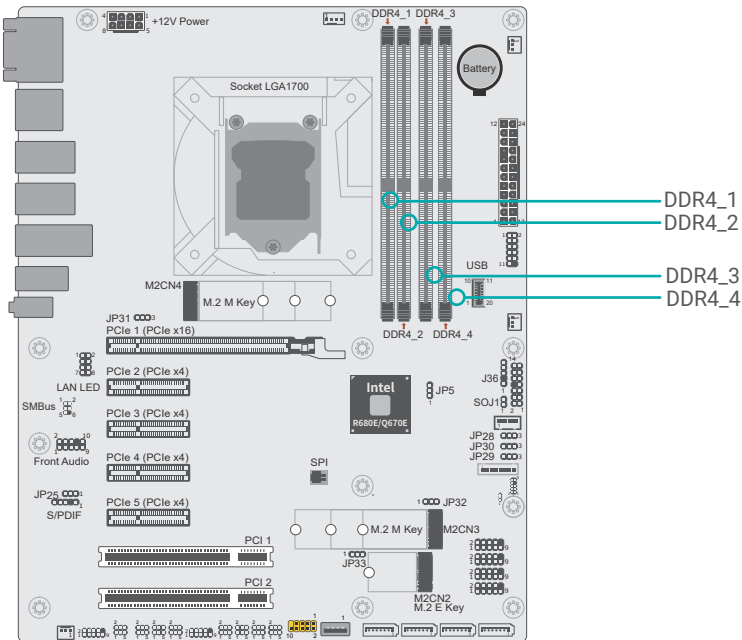

The system board supports the following memory interface.

**Single Channel (SC)**

Data will be accessed in chunks of 64 bits from the memory channels. DIMMs are on the same channel. DIMMs in a channel can be identical or completely different. However, we highly recommend using identical DIMMs. Not all slots need to be populated.

**Dual Channel (DC)**

Data will be accessed in chunks of 128 bits from the memory channels. Dual channel provides better system performance because it doubles the data transfer rate.

Features

- Four 288-pin UDIMM up to 128GB
- Dual Channel DDR4 3200MHz (ECC support: R680E only)

► System Memory

Installing the DIMM Module

Before installing the memory module, please make sure that the following safety cautions are well-attended.

1. Make sure the PC and all other peripheral devices connected to it has been powered down.
2. Disconnect all power cords and cables.
3. Locate the DIMM socket on the system board
4. Make sure the notch on memory card is aligned to the key on the socket.

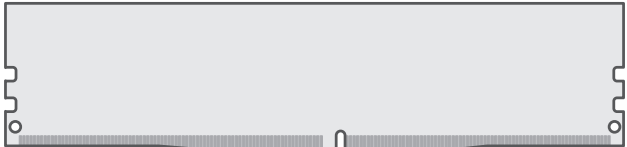

Memory Module

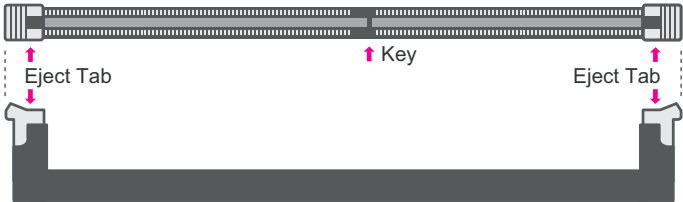

Socket Top View

Socket Side View

► System Memory ► Installing the DIMM Module

Please follow the steps below to install the memory card into the socket.

**Step 1:**  
Press the eject tabs at both ends of the socket outward and downward to release them from the locked position.

**Step 2:**  
Insert the memory card into the slot while making sure the notch and the key are aligned. Press the card down firmly with fingers while applying and maintaining even pressure on both ends.

**Step 3:**  
The tabs snap automatically to the edges of the card and lock the card in place.

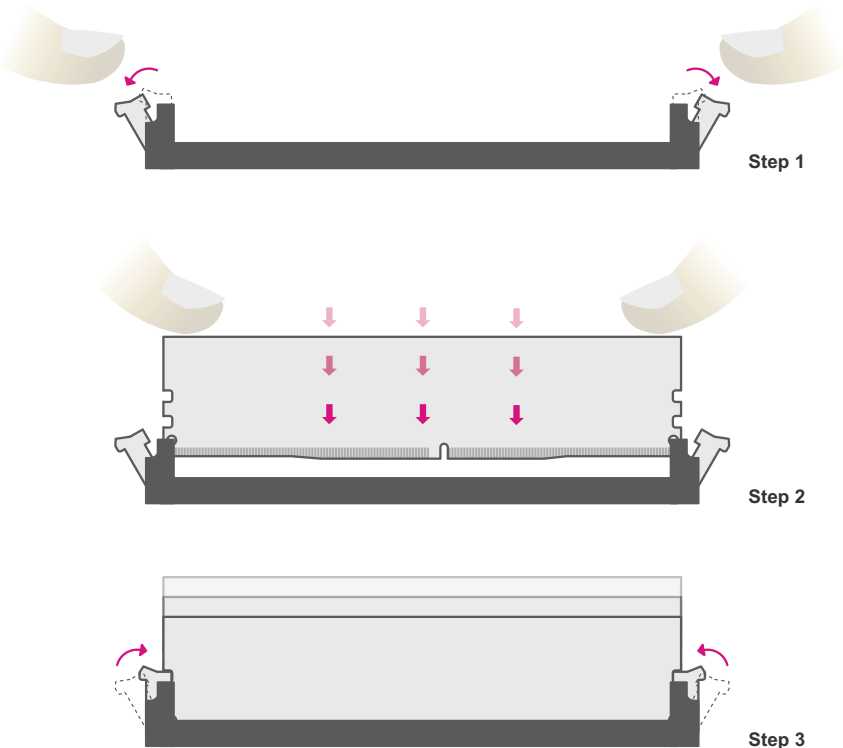

► System Memory

Removing the DIMM Module

Please follow the steps below to remove the memory card from the socket.

**Step 1:**  
Press the eject tabs at both ends of the socket outward and downward to release them from the locked position.

**Step 2:**  
The memory card ejects from the slot automatically.

**Step 3:**  
Hold the card by its edges and remove it from the slot.

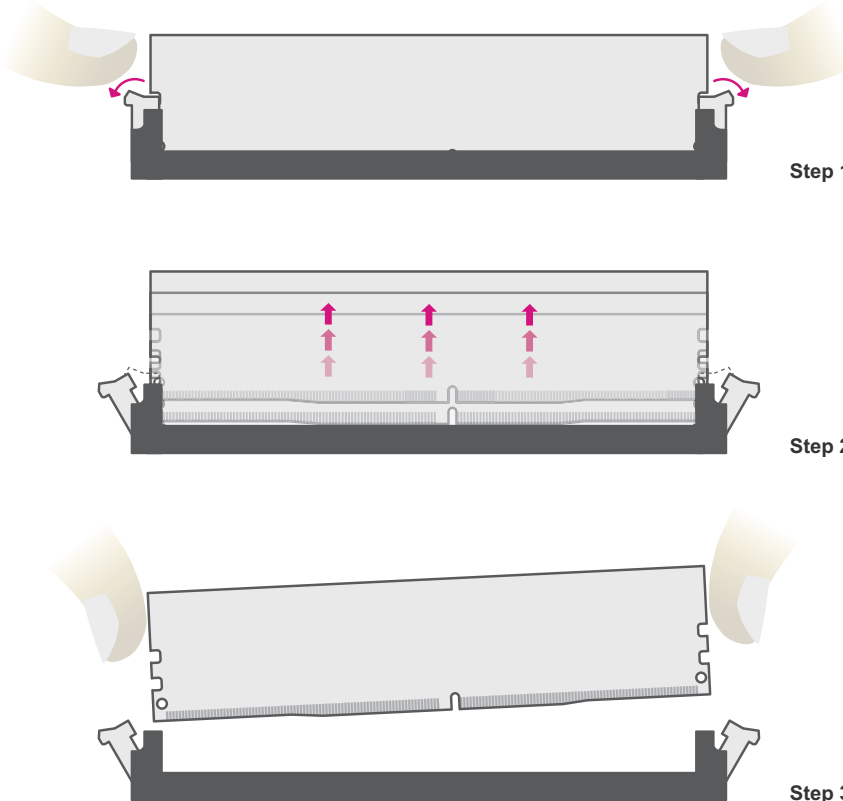

► CPU

Installing the CPU Fan and Heat Sink

The CPU must be kept cool by using a CPU fan with heat sink. Without sufficient air circulation across the CPU and heat sink, the CPU will overheat damaging both the CPU and system board.

Before you place the heat sink on the CPU, you must apply a thermal paste onto the top of the heat sink. The thermal paste is usually supplied when you purchase the fan with heat sink assembly. Do not spread the paste all over the surface. When you later place the CPU on top of the heat sink, the compound will disperse evenly.

Some heat sinks come with a patch of pre-applied thermal paste. Do not apply thermal paste if the fan with heat sink already has a patch of thermal paste on its underside. Peel the strip that covers the paste before you place the CPU on top of the heat sink.

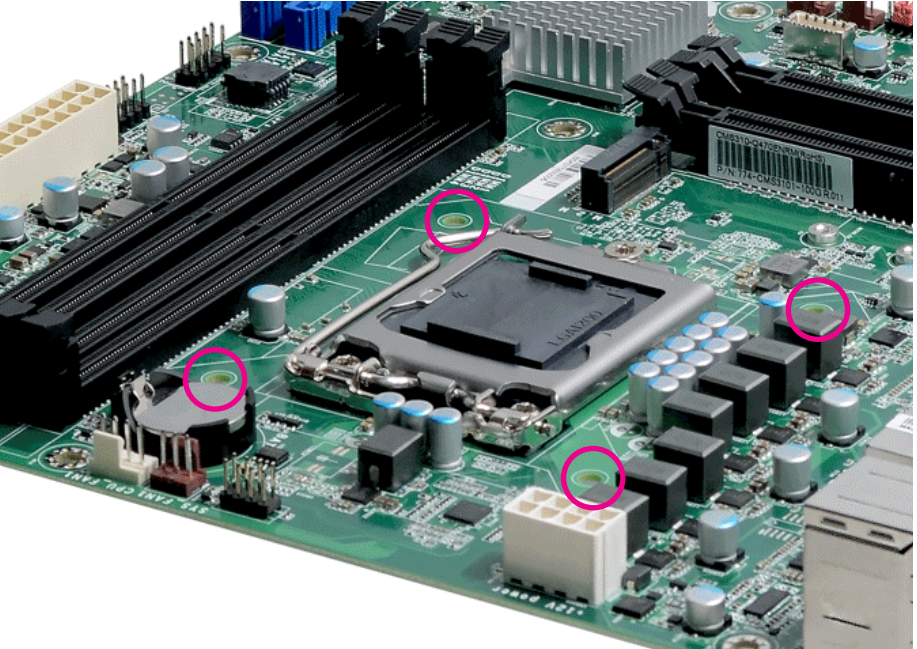

There are 4 screw holes around the CPU for the heat sink to be mounted.

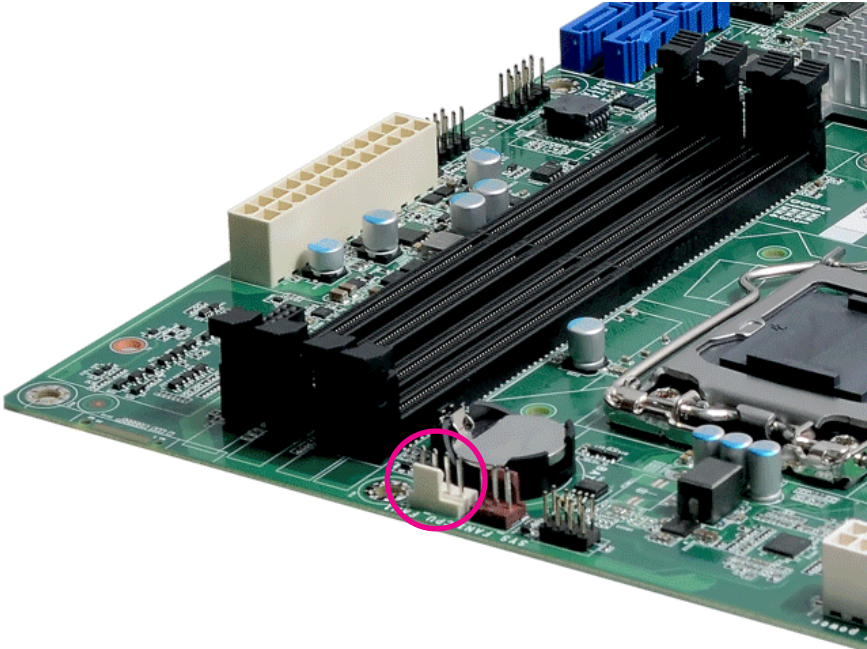

Align the 4 screw holes and tighten the heat sink up by inserting screws, DO remember to connect the fan cable on the board. (The location of fan connector may vary.)

► Jumper Settings

CLEAR CMOS Data

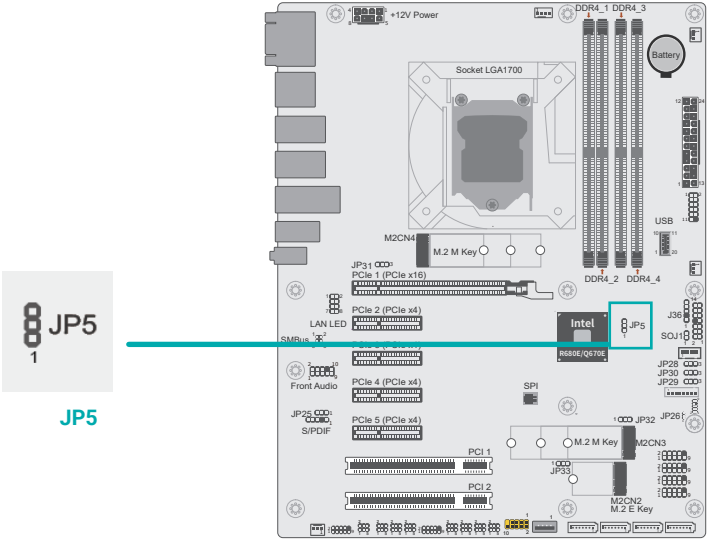

If any anomaly of the followings is encountered –

- a) CMOS data is corrupted;
- b) you forgot the supervisor or user password;
- c) failure to start the system due to BIOS mis-configuration

– it is suggested that the system be reconfigured with default values stored in the ROM BIOS. To load the default values stored in the ROM BIOS, please follow the steps below.

1. Power-off the system and unplug the power cord.
2. Put a jumper cap on pin 2 and pin 3. Wait for a few seconds and set it back to its default setting, i.e. jumper cap on pin 1 and pin 2.
3. Plug the power cord and power-on the system.



■ 1-2 On: Normal (default)



■ 2-3 On: Clear CMOS Data

► Jumper Settings

DIO Power & Voltage - JP28/29/30

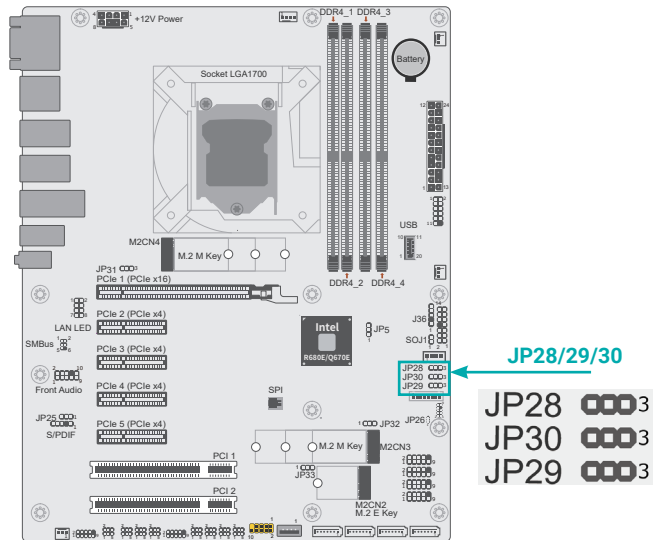

JP28 is used to set DIO Power Voltage. JP29/30 are used to set DIO Power.

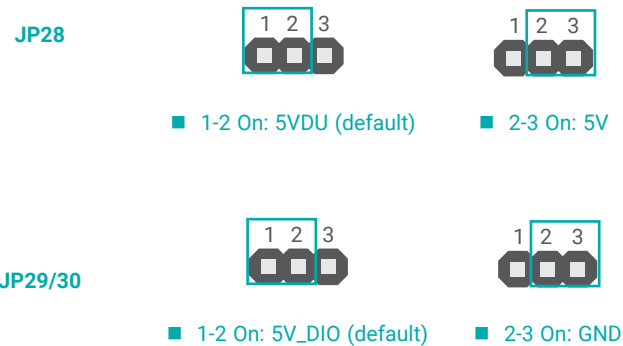

► Jumper Settings

PS/2 and USB Wake up select - JP25

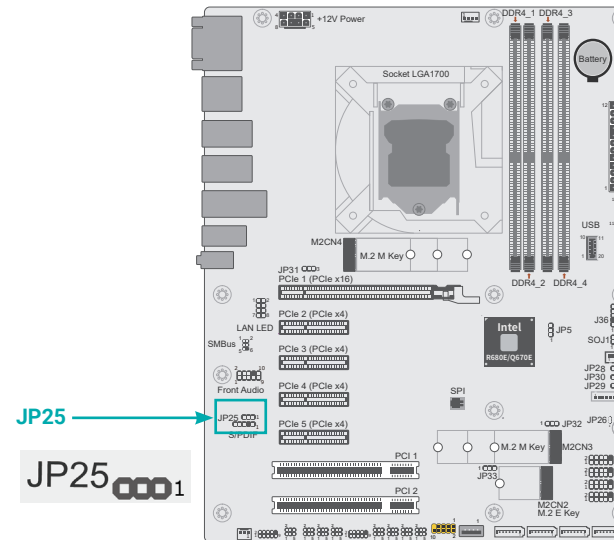

JP25 is used to select PS/2 and USB Wake up.



▶ Jumper Settings

M.2 Connector Power Control - JP31/32/33

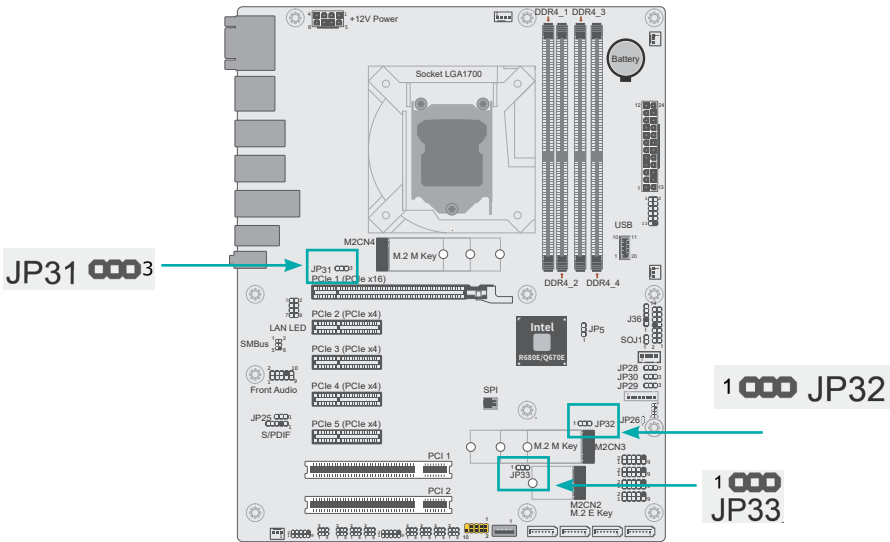

JP31 are used to control the power of M2CN4.  
JP32 are used to control the power of M2CN3.



■ 1-2 On:  
3V3(default)



■ 2-3 On:  
3V3DU

JP33 are used to control the power of M2CN2.



■ 1-2 On:  
3V3DU(default)



■ 2-3 On:  
3V3

▶ Jumper Settings

Power Selection for COM1/COM2-TSJP1/TSJP5

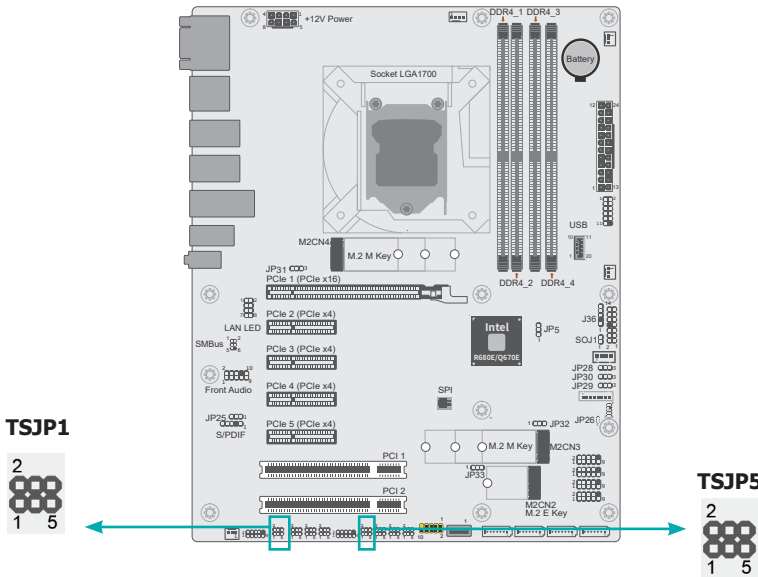

TSJP1 and TSJP5 are used to determine the power of COM1/COM2.

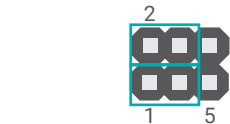

■ 1-3, 2-4 On:  
RS232 Standard (default)

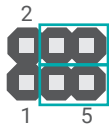

■ 3-5, 4-6 On:  
RS232 with Power

► Jumper Settings

Selection for COM1 / COM2 - TSJP4,3,2 / TSJP8,7,6

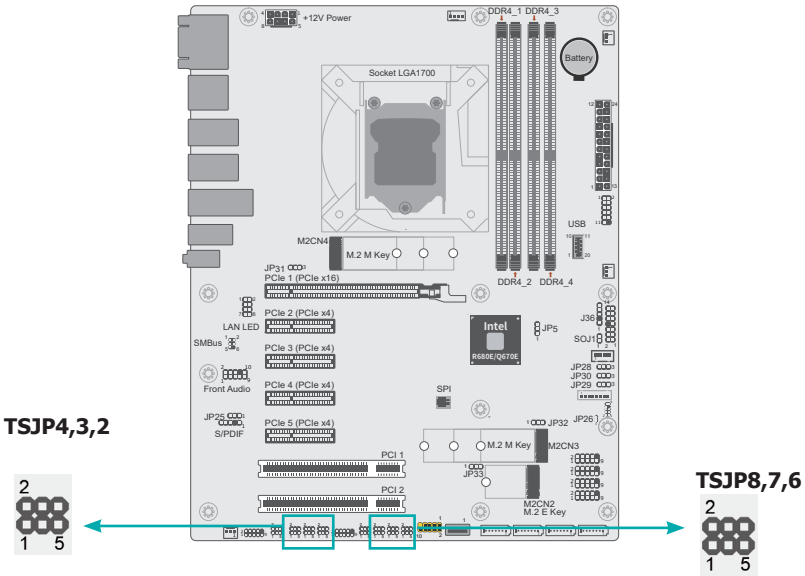

TSJP4,3,2 and TSJP8,7,6 are used to determine the signal type of COM1/COM2.

**TSJP3(COM1), TSJP7(COM2)**

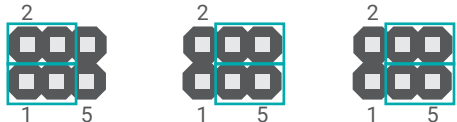

- 1-3, 2-4 On: RS232 (default)
- 3-5, 4-6 On: RS422
- 3-5, 4-6 On: RS485

**TSJP4(COM1), TSJP8(COM2)**

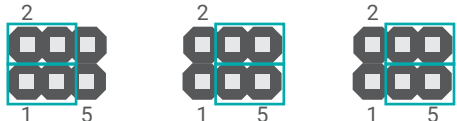

- 1-3, 2-4 On: RS232 (default)
- 3-5, 4-6 On: RS422
- 3-5, 4-6 On: RS485

**TSJP2(COM1), TSJP6(COM2)**

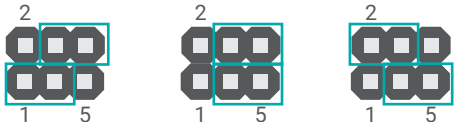

- 1-3, 4-6 On: RS232 (default)
- 3-5, 4-6 On: RS422
- 3-5, 2-4 On: RS485

► **Rear I/O Ports**

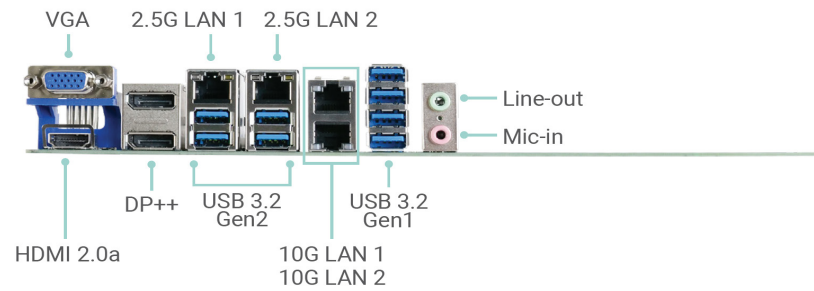

The rear panel I/O ports consist of the following:

- 2 DP++
- 4 USB 3.2 Gen2 ports
- 2.5G LAN 1/2
- 1 HDMI port
- 1 VGA port
- 10G LAN 1/2
- 4 USB 3.2 Gen 1 ports
- 1 Line-in jack (optional)
- 1 Line-out jack
- 1 Mic-in jack

► Rear I/O Ports

USB Ports

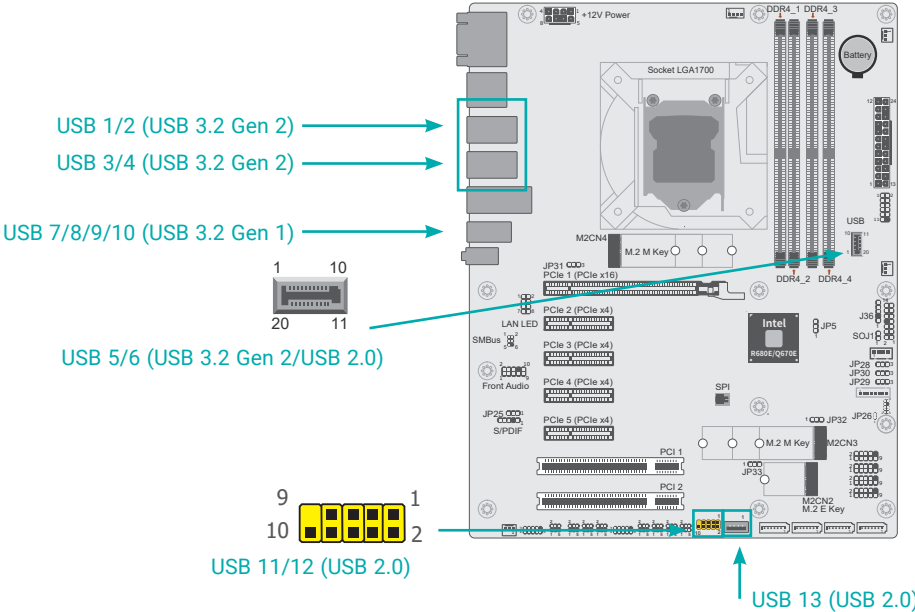

■ USB 2.0 Headers (USB 11/12)

Pin	Assignment	Pin	Assignment
1	SBV6	2	SBV6
3	USBP_C_11N	4	USBP_C_12N
5	USBP_C_11P	6	USBP_C_12P
7	GND	8	GND
9	---	10	N.C.

■ USB 2.0 (USB 13)

Pin	Assignment
1	VBUS
2	DN1
3	DP1
4	GND

The USB device allows data exchange between your computer and a wide range of simultaneously accessible external Plug and Play peripherals. The system board is equipped with multiple USB ports as listed below:

- 4 x USB 3.2 Gen 2 rear ports (USB 1/2/3/4)
- 2 x USB 3.2 Gen 2 / USB 2.0 internal ports (USB 5/6)
- 4 x USB 3.2 Gen 1 rear ports (USB 7/8/9/10)
- 2 x USB 2.0 internal ports, box headers (USB 11/12)
- 1 x USB 2.0 internal ports, (USB 13)

The internal USB ports may be mounted on a card-edge bracket. Install the card-edge bracket to an available slot at the rear of the system chassis and then insert the USB port cables to a connector.

**Wake-On-USB Keyboard/Mouse**

The Wake-On-USB Keyboard/Mouse function allows you to use a USB keyboard or USB mouse to wake up a system from the S3 (STR - Suspend To RAM) state.

► **Rear I/O Ports**

**Graphics Interfaces**

The display ports consist of the following:

- 2 DP++ Port
- 1 HDMI port
- 1 VGA port

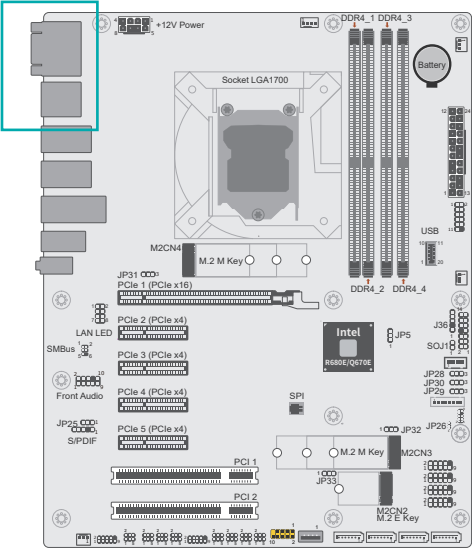

**DP++ Port**

The DP++ port which carries both digital audio and video signals is used to connect a LCD monitor or a digital TV that has the DP++ port.

**HDMI Port**

The HDMI port which carries both digital audio and video signals is used to connect a LCD monitor or digital TV that has the HDMI port.

**VGA Port**

The VGA port is used for connecting a VGA monitor. Connect the monitor's 15-pin D-shell cable connector to the VGA port. After you plug the monitor's cable connector into the VGA port, gently tighten the cable screws to hold the connector in place.

► Rear I/O Ports

LAN Ports

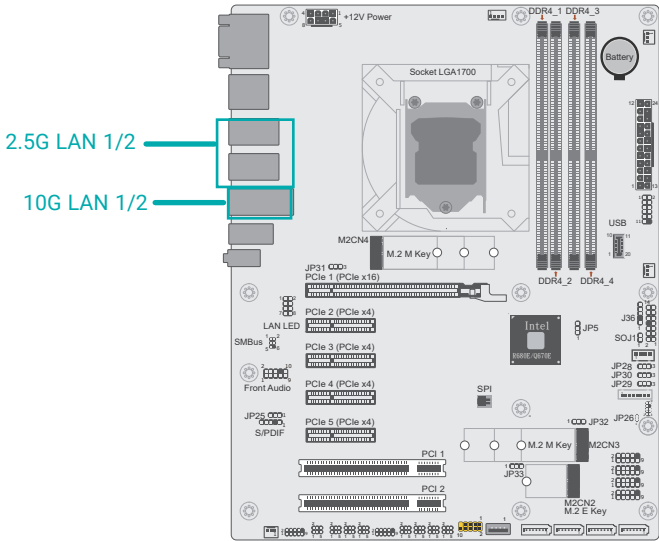

Features

- 2 x 2.5GbE (RJ-45), 2 x 10GbE

The LAN ports allow the system board to connect to a local area network by means of a network hub.

► Rear I/O Ports

Audio

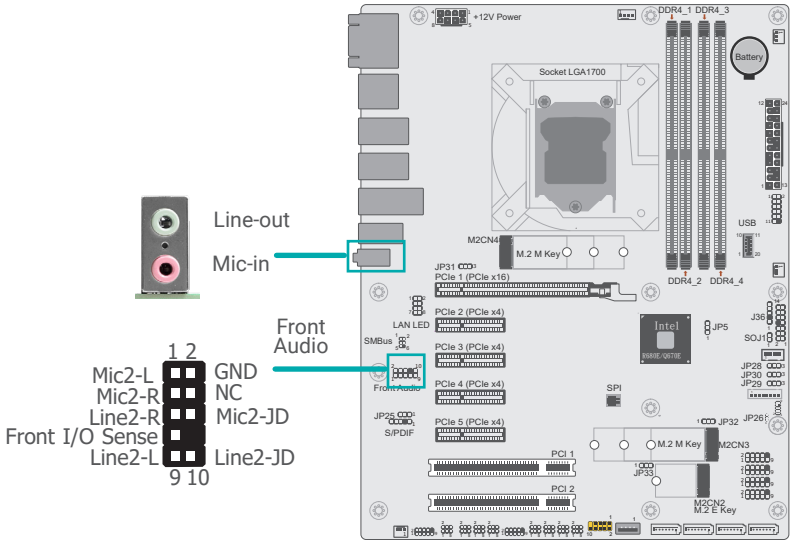

Rear Audio

The system board is equipped with 2 audio jacks (Line-out and Mic-in). Line-in jack is available upon request. A jack is a one-hole connecting interface for inserting a plug.

- Optional Line-in Jack (Light Blue)
  - This jack is used to connect any audio devices such as Hi-fi set, CD player, tape player, AM/FM radio tuner, synthesizer, etc.
- Line-out Jack (Lime)
  - This jack is used to connect a headphone or external speakers.
- Mic-in Jack (Pink)
  - This jack is used to connect an external microphone.

Front Audio

The front audio connector allows you to connect to the second line-out and mic-in jacks that are at the front panel of your system.

Internal I/O Connectors

SATA (Serial ATA)

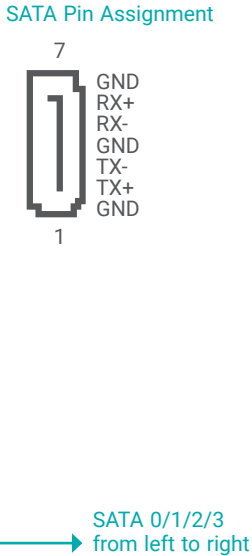
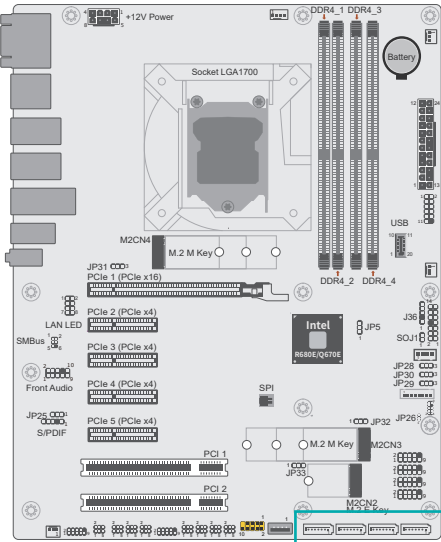

The Serial ATA (SATA) connectors are used to connect the Serial ATA device. SATA 3.0 is supported by the SATA ports and provides data rate up to 6Gb/s. Connect one end of the Serial ATA cable to a SATA connector and the other end to your Serial ATA device.

Features

- 4 Serial ATA 3.0 ports with data transfer rate up to 6Gb/s
- Integrated Advanced Host Controller Interface (AHCI) controller
- Support RAID 0, RAID 1, RAID 5, RAID 10

Internal I/O Connectors

Digital I/O Connector, DIO Power

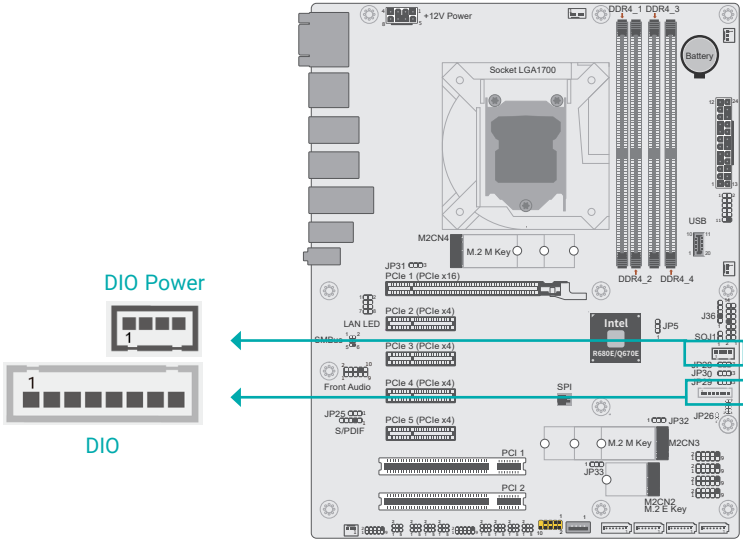

The 8-bit Digital I/O connector provides powering-on function to external devices that are connected to these connectors. The pin functions of the 8-bit digital I/O connector are listed below.

DIO		DIO Power	
Pin	Assignment	Pin	Assignment
1	D_IOA0	1	12V
2	D_IOA1	2	GND
3	D_IOA2	3	5V <sub>DU</sub>
4	D_IOA3	4	5V
5	D_IOA4		
6	D_IOA5		
7	D_IOA6		
8	D_IOA7		

► Internal I/O Connectors

COM (Serial) ports

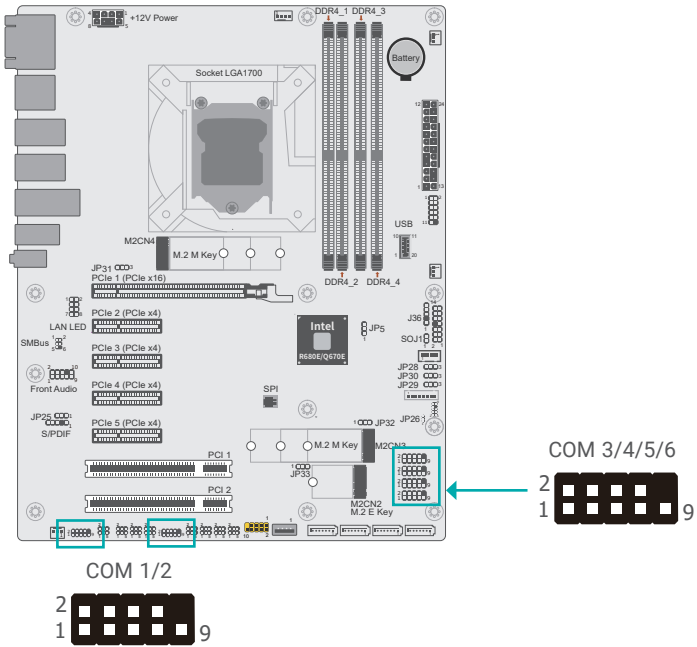

The pin functions of COM1/2 port will vary according to setting.

COM3/4/5/6 : RS232 only

**Connecting External Serial Ports**

Your COM port may come mounted on a card-edge bracket. Install the card-edge bracket to an available slot at the rear of the system chassis then insert the serial port cable to the COM connector. Make sure the colored stripe on the ribbon cable is aligned with pin 1 of the COM connector.

■ COM Port Pin Assignment

Pin	RS232	RS232 with PWR	RS422 Full Duplex	RS485
1	DCD-	+12V	RX+	Data+
2	SIN-	SIN-	RX-	Data-
3	SO-	SO-	TX+	---
4	DTR-	DTR-	TX-	---
5	GND	GND	GND	GND
6	DSR-	DSR-	---	---
7	RTS-	RTS-	---	---
8	CTS-	CTS-	---	---
9	RI-	+5V	---	---

Internal I/O Connectors

Cooling Fan Connectors

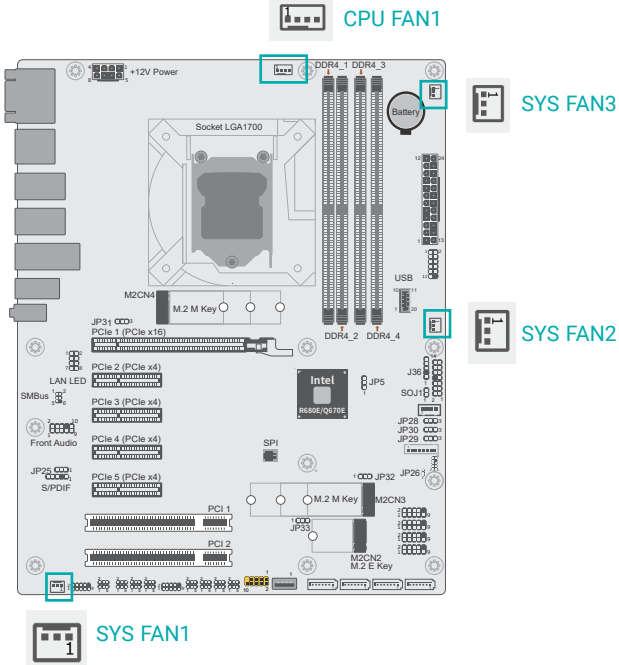

These fan connectors are used to connect cooling fans. The cooling fans will provide adequate airflow throughout the chassis to prevent overheating the CPU and system board components.

4-pin Fan Pin Assignment

Pin	Assignment
1	Ground
2	12V
3	RPM
4	Control

3-pin Fan Pin Assignment

Pin	Assignment
1	GND
2	PWM
3	TACH

Internal I/O Connectors

Power Connector

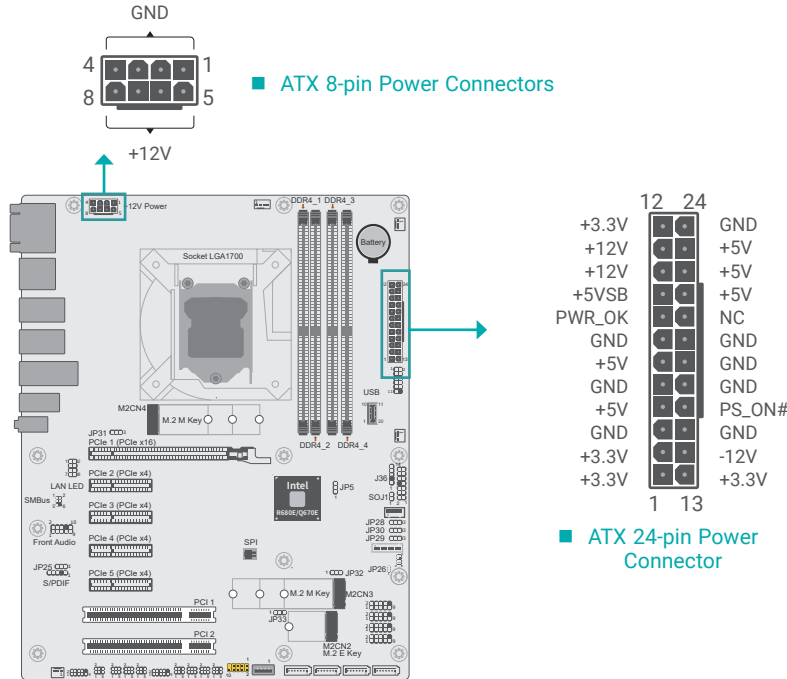

Use a power supply that complies with the ATX12V Power Supply Design Guide Version 1.1. An ATX12V power supply unit has a standard 24-pin ATX main power connector that must be inserted into the 24-pin connector. The 8-pin +12V power connector enables the delivery of more +12VDC current to the processor's Voltage Regulator Module (VRM).

The power connectors from the power supply unit are designed to fit the 24-pin and 8-pin connectors in only one orientation. Make sure to find the proper orientation before plugging the connectors.

The system board requires a minimum of 300 Watt power supply to operate. Your system configuration (CPU power, amount of memory, add-in cards, peripherals, etc.) may exceed the minimum power requirement. To ensure that adequate power is provided, we strongly recommend that the system is supplied with a minimum of 400 Watt power.



**Important:**

Insufficient power supplied to the system may result in instability or malfunction of the add-in boards and peripherals. Calculating the system's approximate power usage is important to ensure that the power supply meets the system's consumption requirements.

► Internal I/O Connectors

Front Panel

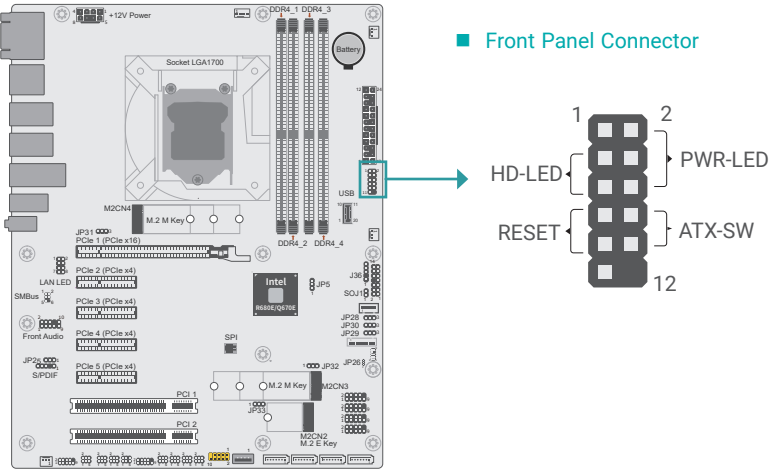

■ Front Panel Pin Assignment

Pin	Assignment	Pin	Assignment	
1	N.C.	2	V_SUS_LED	
3	3V3	PWR-LED	4	V_SUS_LED
HD-LED	5	HD_LED	6	SUS_LED
RESET	7	Ground	8	Ground
9	SYS_RST-	ATX-SW	10	PWR_BTN-
11	N.C.	12	--	

**HDD LED - Hard Disk Drive LED**

Lighting of the LED indicates that the hard drive is being accessed.

**RESET - Reset Switch**

This switch allows you to reboot without having to power off the system.

**Power/Standby LED**

When the system's power is on, this LED will light up. When the system is in the S1 (POS - Power On Suspend) state, it will blink at 1-second intervals. When the system is in the S3 (STR - Suspend To RAM) state, it will blink at 4-second intervals.

**Power Button**

This button is used to switch the system's power on or off .

► Internal I/O Connectors

S/PDIF Connector

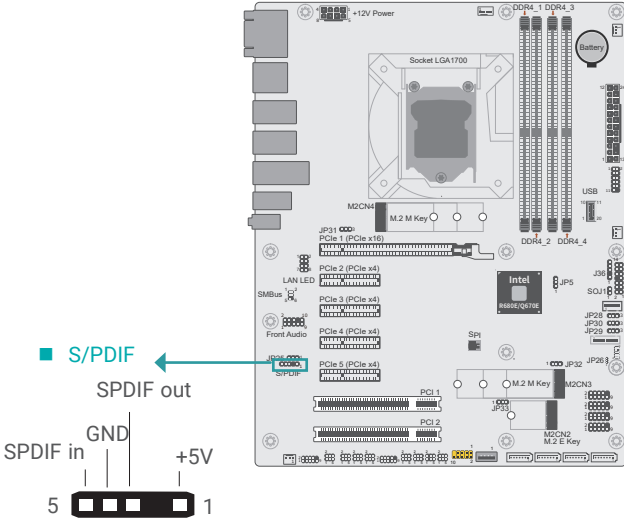

The S/PDIF connector is used to connect an external S/PDIF port. Your S/PDIF port may be mounted on a card-edge bracket. Install the card-edge bracket to an available slot at the rear of the system chassis then connect the audio cable to the S/PDIF connector. Make sure pin 1 of the audio cable is aligned with pin 1 of the S/PDIF connector.



▶ Internal I/O Connectors

Front Audio

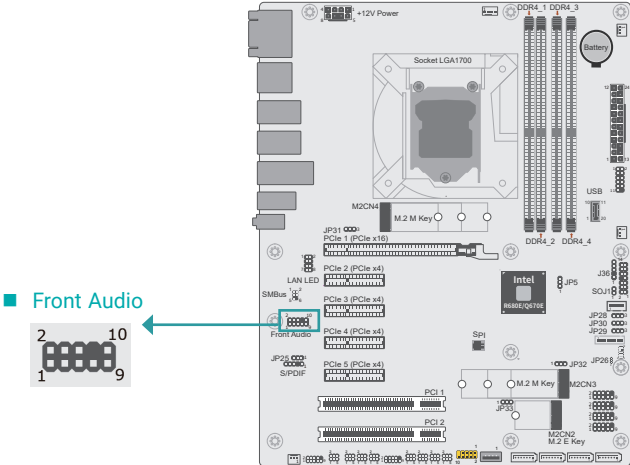

Pin	Assignment	Pin	Assignment
1	MIC2-L	2	A_GND
3	MIC2-R	4	NC
5	LINE2-R	6	MIC2-JD
7	A_GND		
9	LINE2-L	10	LINE2-JD

▶ Internal I/O Connectors

Front LAN LED

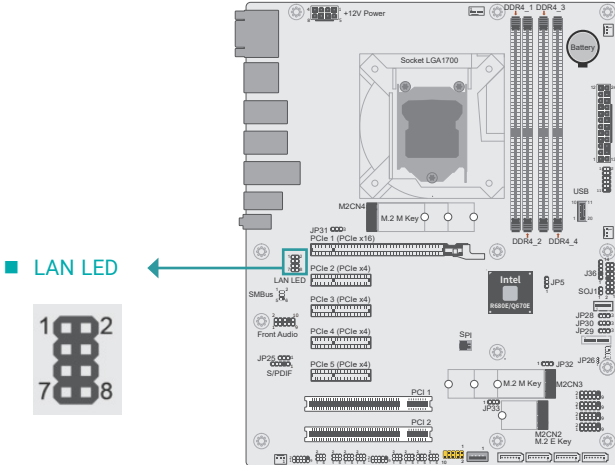

Pin	Assignment	Pin	Assignment
1	LED_SPEED_2500#	2	LED_SPEED_1000#
3	GBE_LED_LINK_ACT#	4	3V3DU
5	LED_SPEED_2500#_2	6	LED_SPEED_1000#_2
7	GBE_LED_LINK_ACT#_2	8	3V3DU

▶ Internal I/O Connectors

PS/2

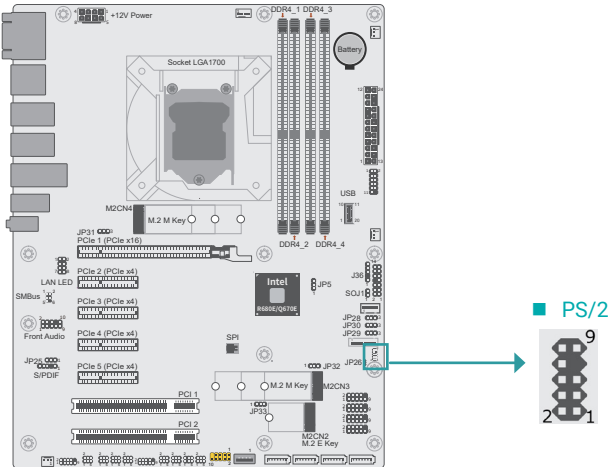

Pin	Assignment	Pin	Assignment
1	PS2_KCLK	2	PS2_MCLK
3	PS2_KDAT	4	PS2_MDAT
5	GND	6	GND
		8	GND
9	PS/2 POWER	10	PS/2 POWER

▶ Internal I/O Connectors

USB 3.2 Gen2 Key B

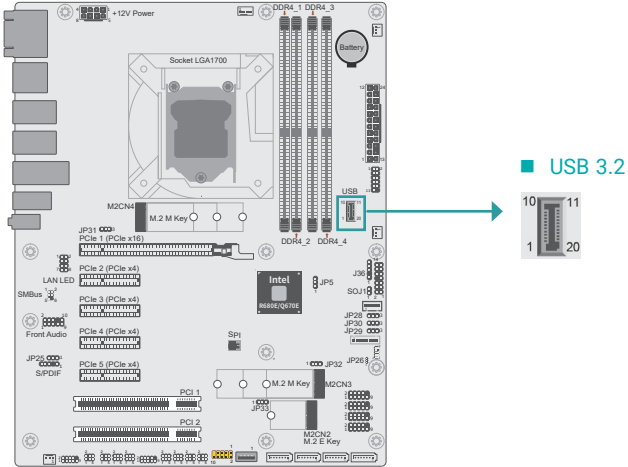

Pin	Assignment	Pin	Assignment
1	GND	11	GND
2	SSTXP1	12	SSTXN2
3	SSTXN1	13	SSTXP2
4	GND	14	GND
5	SSRXP1	15	SSRXN2
6	SSRXN1	16	SSRXP2
7	GND	17	GND
8	DP1	18	DP2
9	DN1	19	DN2
10	VBUS	20	VBUS

▶ Internal I/O Connectors

USB 2.0

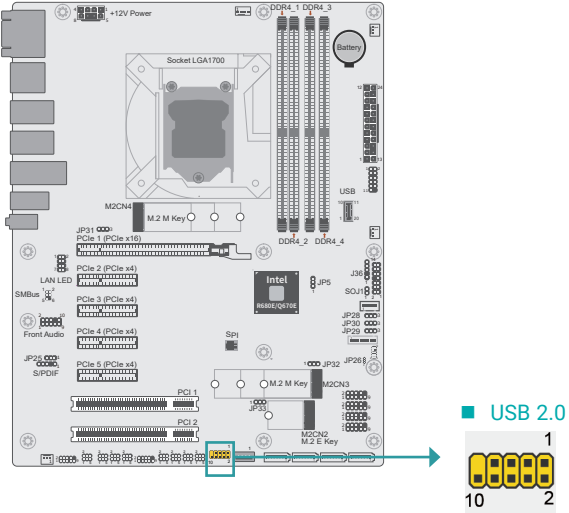

Pin	Assignment	Pin	Assignment
1	VBUS	2	VBUS
3	DN1	4	DN2
5	DP1	6	DP2
7	GND	8	GND
		10	NC

▶ Internal I/O Connectors

USB 2.0

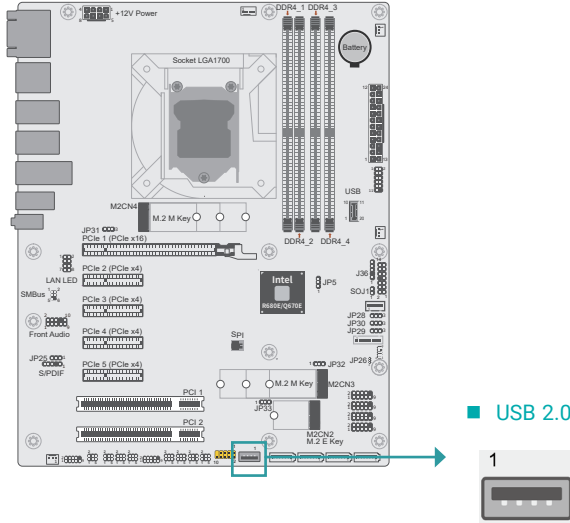

Pin	Assignment	Pin	Assignment
1	VBUS	2	VBUS
3	DN1	4	DN2
5	DP1	6	DP2
7	GND	8	GND
		10	NC

► Internal I/O Connectors

Expansion Slots

- a PCIe 1 (PCIe x16)
- b PCIe 2 (PCIe x4)
- c PCIe 3 (PCIe x4)
- d PCIe 4 (PCIe x4)
- e PCIe 5 (PCIe x4)
- f PCI1
- g PCI2
- h M.2-M
- i M.2-M
- j M.2-E

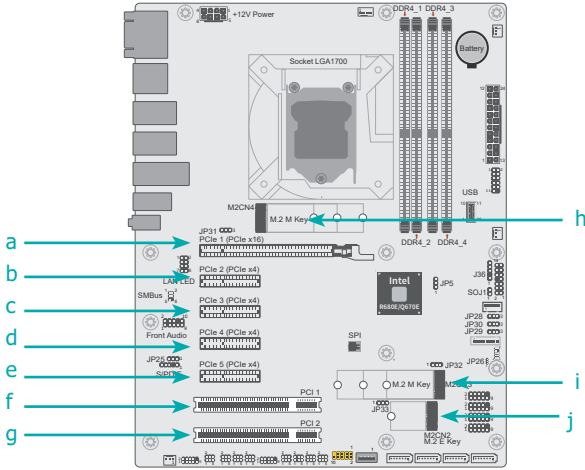

**PCI Express x16 Slot**

Install a PCI Express x16 graphics card that complies to the PCI Express specifications into the PCI Express x16 slot. To install a graphics card into the x16 slot, align the graphics card to the socket and perpendicularly to the board, be cautious in aligning the locations of notch and key, and then press the card down firmly until it is completely seated. The retaining clip of the slot will close up automatically to hold the graphics card in place.

**PCI Express x4 Slots**

Install PCI Express cards such as network cards or other expansion cards

**PCI Slots**

Install PCI cards for other expansion demands.

**M.2 Socket**

The M.2 socket is the Next Generation Form Factor (NGFF) which is designed to support multiple modules and make the M.2 more suitable in application for solid-state storage.

► Internal I/O Connectors ► Expansion Slots

Installing the M.2 Module

Before installing the M.2 module into the M.2 socket, please make sure that the following safety cautions are well-attended.

1. Make sure the PC and all other peripheral devices connected to it has been powered down.
2. Disconnect all power cords and cables.
3. Locate the M.2 socket on the system board
4. Make sure the notch on card is aligned to the key on the socket.
5. Make sure the standoff screw is removed from the standoff.

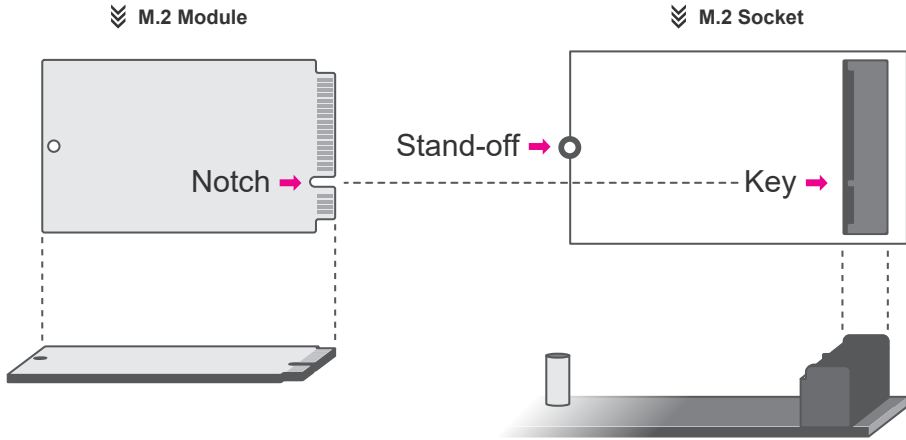

Please follow the steps below to install the card into the socket.

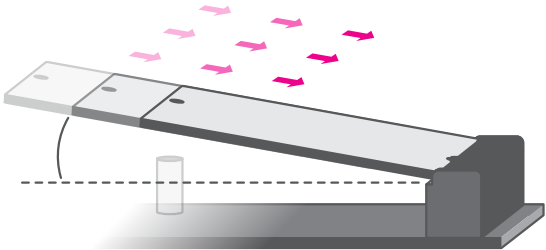

**Step 1:**  
Insert the card into the socket at an angle while making sure the notch and key are perfectly aligned.

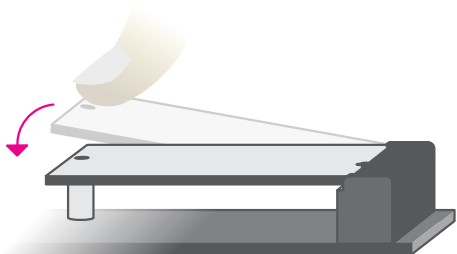

**Step 2:**  
Press the end of the card far from the socket down until the gap between the card and the stand-off closes up.



**Step 3:**  
Screw tight the card onto the stand-off with a screw driver and a stand-off screw until the gap between the card and the stand-off closes up. The card should be lying parallel to the board when it's correctly mounted.

Battery

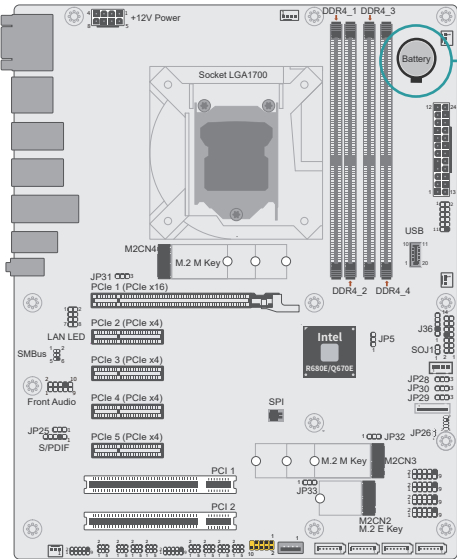

■ Battery

The lithium ion battery addendum supplies power to the real-time clock and CMOS memory as an auxiliary source of power when the main power is shut off. Insert a coin cell battery into the holder and make sure the polarities are correctly oriented – the cap side (rimmed rounded edge) is negative and should be facing the holder; the flat side with a + mark is positive and should be facing away from the holder.

Safety Measures

- There exists explosion hazard if the battery is incorrectly installed.
- Replace only with the same or equivalent type recommended by the manufacturer.
- Dispose of used batteries according to local ordinances.

## Chapter 3 - BIOS Settings

### ► Overview

The BIOS is a program that takes care of the basic level of communication between the CPU and peripherals. It contains codes for various advanced features found in this system board.

The BIOS allows you to configure the system and save the configuration in a battery-backed CMOS so that the data retains even when the power is off. In general, the information stored in the CMOS RAM of the EEPROM will stay unchanged unless a configuration change has been made such as a hard drive replaced or a device added.

It is possible that the CMOS battery will fail causing CMOS data loss. If this happens, you need to install a new CMOS battery and reconfigure the BIOS settings.



**Note:**

The BIOS is constantly updated to improve the performance of the system board; therefore the BIOS screens in this chapter may not appear the same as the actual one. These screens are for reference purpose only.

### Default Configuration

Most of the configuration settings are either predefined according to the Load Optimal Defaults settings which are stored in the BIOS or are automatically detected and configured without requiring any actions. There are a few settings that you may need to change depending on your system configuration.

### Entering the BIOS Setup Utility

The BIOS Setup Utility can only be operated from the keyboard and all commands are keyboard commands. The commands are available at the right side of each setup screen.

The BIOS Setup Utility does not require an operating system to run. After you power up the system, the BIOS message appears on the screen and the memory count begins. After the memory test, the message "Press DEL to run setup" will appear on the screen. If the message disappears before you respond, restart the system or press the "Reset" button. You may also restart the system by pressing the <Ctrl> <Alt> and <Del> keys simultaneously.

### Legends

Keys	Function
Right / Left arrow	Move the highlight left or right to select a menu
Up / Down arrow	Move the highlight up or down between submenus or fields
<Enter>	Enter the highlighted submenu
+ (plus key)/F6	Scroll forward through the values or options of the highlighted field
- (minus key)/F5	Scroll backward through the values or options of the highlighted field
<F1>	Display general help
<F2>	Display previous values
<F9>	Optimized defaults
<F10>	Save and Exit
<Esc>	Return to previous menu

### Scroll Bar

When a scroll bar appears to the right of the setup screen, it indicates that there are more available fields not shown on the screen. Use the up and down arrow keys to scroll through all the available fields.

### Submenu

When "►" appears on the left of a particular field, it indicates that a submenu which contains additional options are available for that field. To display the submenu, move the highlight to that field and press <Enter>.

► Main

The Main menu is the first screen that you will see when you enter the BIOS Setup Utility.

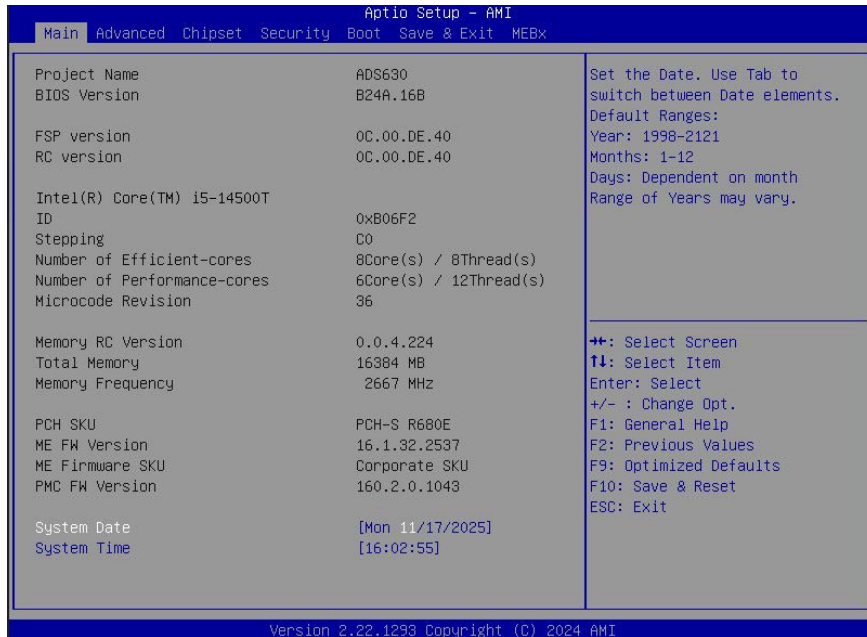

**System Date**

The date format is <month>, <date>, <year>. Press "Tab" to switch to the next field and press "-" or "+" to modify the value.

**System Time**

The time format is <hour>, <minute>, <second>. The time is based on the 24-hour military-time clock. For example, 1 p.m. is 13:00:00. Hour displays hours from 00 to 23. Minute displays minutes from 00 to 59. Second displays seconds from 00 to 59.

► Advanced

The Advanced menu allows you to configure your system for basic operation. Some entries are defaults required by the system board, while others, if enabled, will improve the performance of your system or let you set some features according to your preference.



**Important:**  
Setting incorrect field values may cause the system to malfunction.

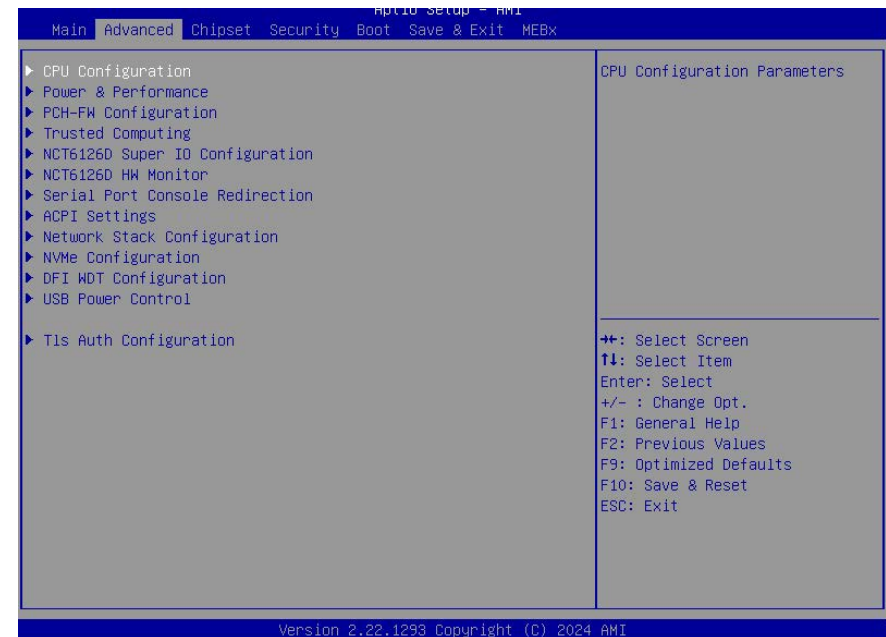

▶ Advanced

CPU Configuration

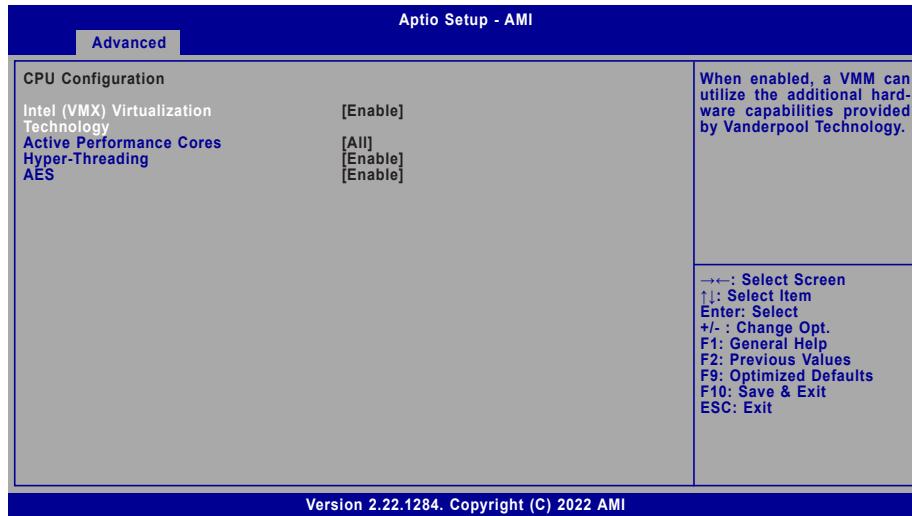

**Intel (VMX) Virtualization Technology**

When this field is set to Enabled, the VMM can utilize the additional hardware capabilities provided by Vanderpool Technology.

**Active Performance Cores**

Select number of cores to enable in each processor package.

**Hyper-threading**

Enables this field for Windows XP and Linux which are optimized for Hyper-Threading technology. Select disabled for other OSes not optimized for Hyper-Threading technology. When disabled, only one thread per enabled core is enabled.

**AES**

Enable or disable AES function.



**Note:** Some of the fields may not be available when the features are not supported by the equipped CPU.

▶ Advanced

Power & Performance

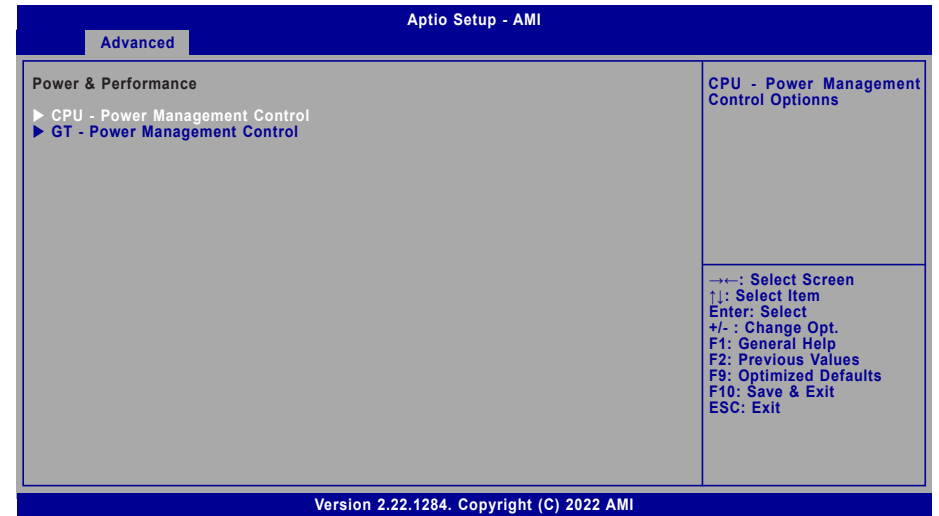

▶ **CPU - Power Management Control Options**

**Intel(R) SpeedStep(tm)**

This field is used to enable or disable the Intel SpeedStep® Technology, which helps optimize the balance between system's power consumption and performance. After it is enabled in the BIOS, EIST features can then be enabled via the operating system's power management.

**Turbo Mode**

Enable or disable turbo mode of the processor. This field will only be displayed when EIST is enabled.

**Platform PL1/PL2 Enable**

Enable or disable Platform Power Limit 1 programming. If this options is enabled, it activates the PL1 value to be used by the processor to limit the average power of given time window.

**C states**

Enable or disable CPU Power Management. It allows CPU to enter "C states" when it's idle and nothing is executing.

▶ Advanced

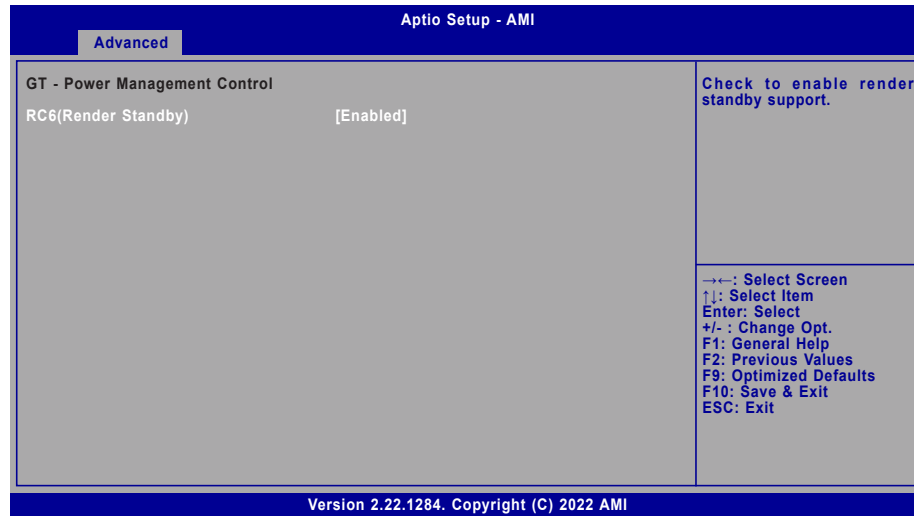

▶ **GT - Power Management Control**

**RC6 (Render Standby)**

Check to enable render standby support.

▶ Advanced

PCH-FW Configuration

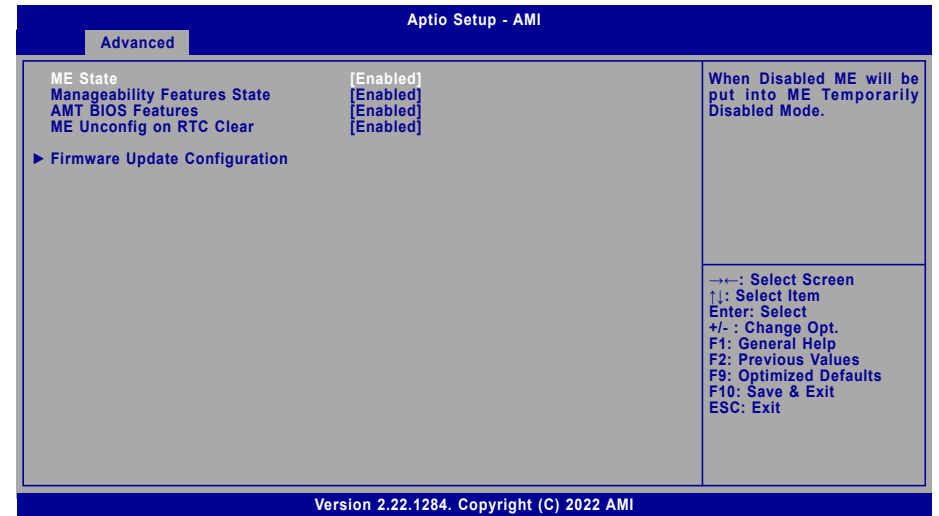

**ME State**

When this field is set to Disabled, ME will be put into ME Temporarily Disabled Mode.

**Manageability Features State**

Enable or disable Intel(R) Manageability features. This option disables/enables Manageability Features support in FW. To disable, support platform must be in an unprovisioned state first.

**AMT BIOS Features**

When disabled, AMT BIOS features are no longer supported and user is no longer able to access MEBx Setup. This option does not disable manageability features in FW.

**ME Unconfig on RTC Clear**

When disabled, ME will not be unconfigured on RTC Clear.

▶ **Firmware Update Configuration**

Configure firmware update.

▶ **Advanced**

**Trusted Computing**

Aptio Setup - AMI		
Advanced		
TPM2.0 Device Found	7.2	Enables or Disables BIOS support for security device. O.S will not show Security Device. TCG EFI protocol and INT1A interface will not be available.
Firmware Version	NTC	
Security Device Support	[Enable]	→←: Select Screen ↑↓: Select Item Enter: Select +/- : Change Opt. F1: General Help F2: Previous Values F9: Optimized Defaults F10: Save & Exit ESC: Exit
Active PCR banks	SHA256	
Available PCR banks	SHA256, SHA384	
Version 2.22.1284. Copyright (C) 2022 AMI		

**Security Device Support**

This field is used to enable or disable BIOS support for the security device such as an TPM 2.0 to achieve hardware-level security via cryptographic keys.

▶ Advanced

NCT6126D Super IO Configuration

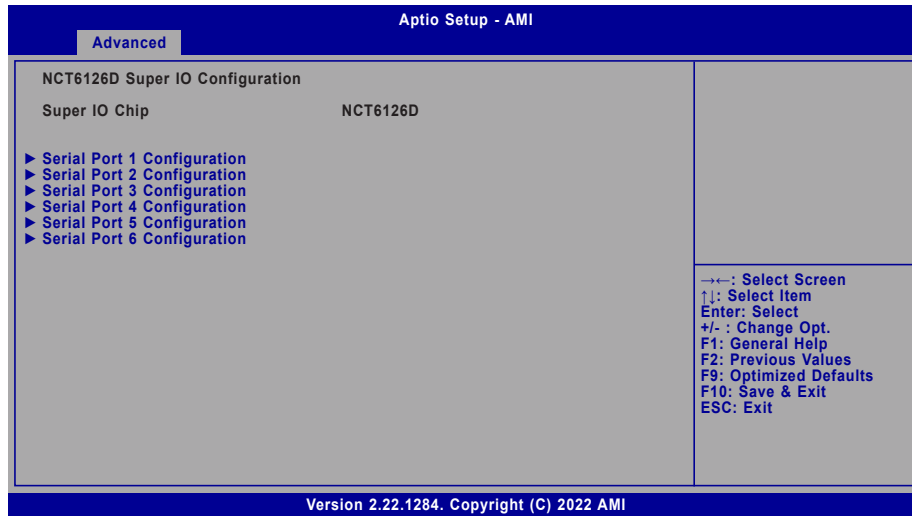

▶ Advanced ▶ NCT6126D Super IO Configuration

▶ Serial Port Configuration

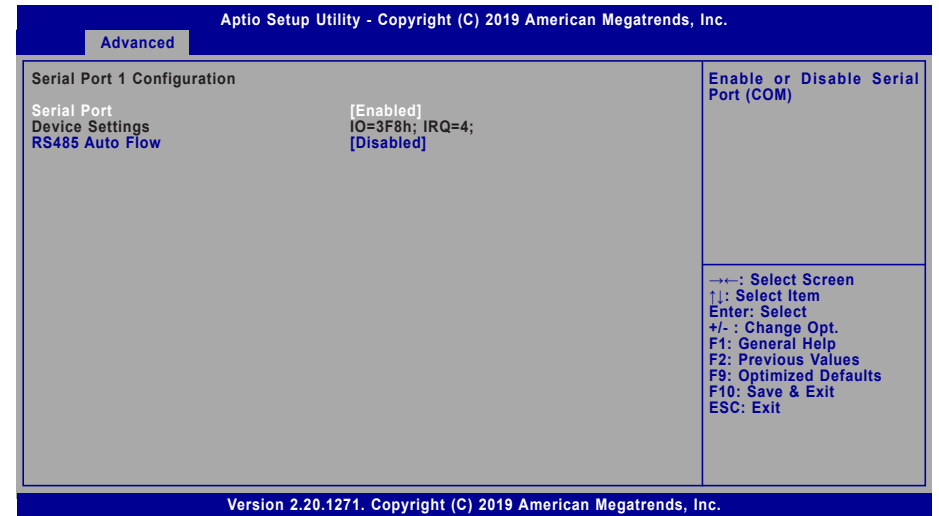

**Note:**

The sub-menus are detailed in following sections.

**Serial Port**

Enable or disable the current serial COM port.

**RS485 Auto Flow**

Enable or disable RS485 auto flow. This field is only available for COM ports that support RS485 mode.

## NCT6126D HW Monitor

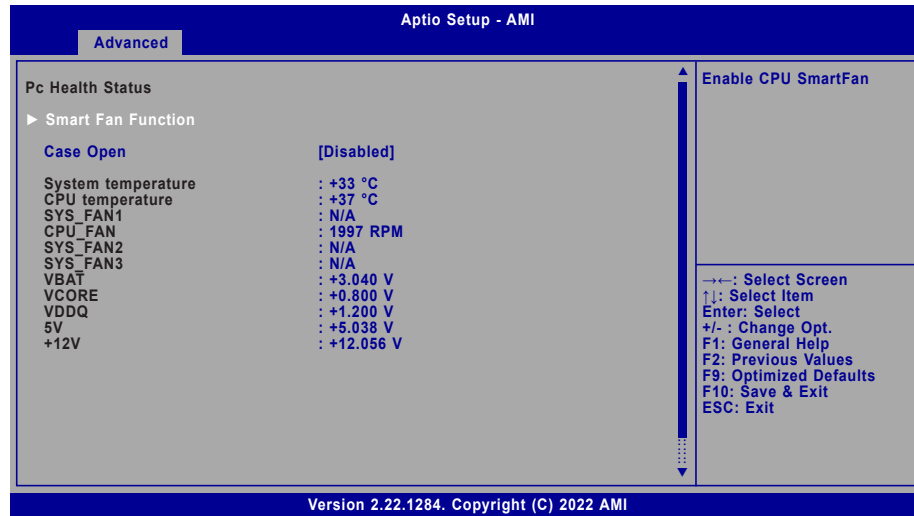

Smart Fan is a fan speed moderation strategy dependent on the current system temperature. When the system temperature goes higher than the Boundary setting, the fan speed will be turned up to the setting of the Fan Speed Count that bears the same index as the Boundary field.

### ▼ SYS Smart Fan/CPU Smart Fan Control = [Enabled]

#### Boundary 1 to Boundary 4

Set the boundary temperatures that determine the fan speeds accordingly, the value ranging from 0-127°C. For example, when the system temperature reaches Boundary 1 setting, the fan speed will be turned up to the designated speed of the Fan Speed Count 1 field.

#### Fan Speed Count 1 to Fan Speed Count 4

Set the fan speed, the value ranging from 1-100%, 100% being full speed. The fans will operate according to the specified boundary temperatures above-mentioned.

### ▼ SYS Smart Fan/CPU Smart Fan Control = [Disabled]

#### Fix Fan Speed Count

Set the fan speed, the value ranging from 1-100%, 100% being full speed. The fans will always operate at the specified speed regardless of gauged temperatures.

▶ Advanced

Serial Port Console Redirection

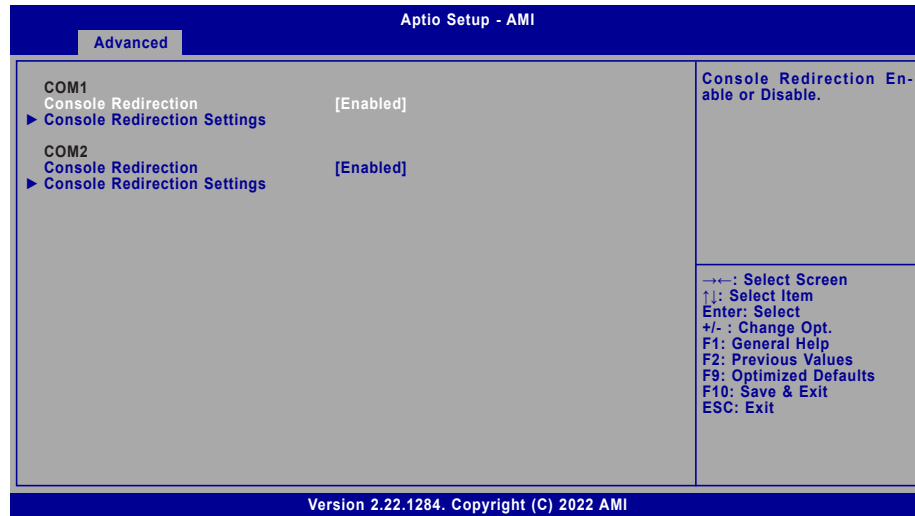

**Console Redirection**

By enabling Console Redirection of a COM port, the sub-menu of console redirection settings will become available for configuration as detailed in the following.

▶ Advanced ▶ Serial Port Console Redirection

▶ Console Redirection Settings

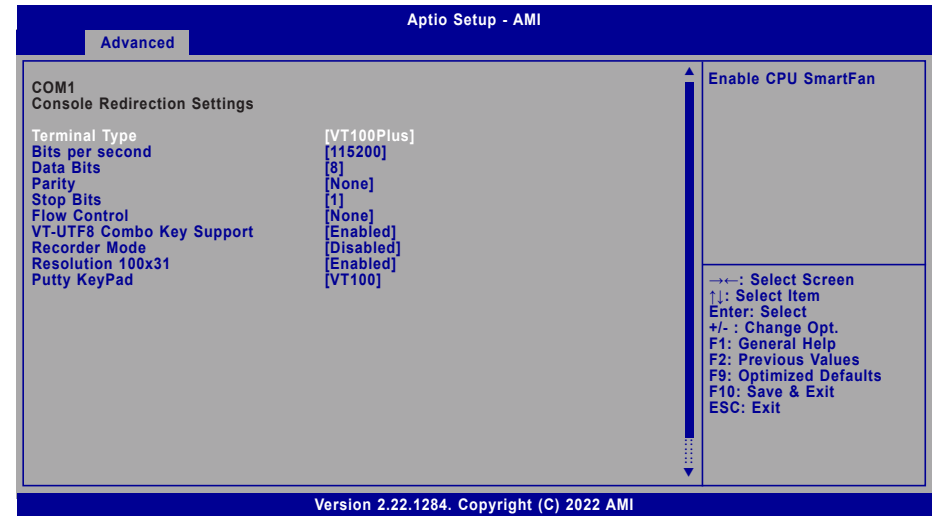

Configure the serial settings of the current COM port.

**Terminal Type**

Select terminal type: VT100, VT100Plus, VT-UTF8 or ANSI.

**Bits per second**

Select serial port transmission speed: 9600, 19200, 38400, 57600 or 115200.

**Data Bits**

Select data bits: 7 bits or 8 bits.

**Parity**

Select parity bits: None, Even, Odd, Mark or Space.

**Stop Bits**

Select stop bits: 1 bit or 2 bits.

**Flow Control**

Select flow control type: None or Hardware RTS/CTS. Flow Control is for RS485 mode and is only supported by Serial Port 1 (COM1).

**VT-UTF8 Combo Key Support**

Enable or disable VT-UTF8 Combination Key Support for ANSI/VT100 terminals.

### Recorder Mode

With this mode enabled only text will be sent. This is to capture Terminal data.

### Resolution 100x31

Enables or disables extended terminal resolution.

### Putty Keypad

Select FunctionKey and KeyPad on Putty.

- VT100
- LINUX
- XTERMR6
- SCO
- ESCN
- VT400

### ▶ Advanced

## ACPI Configuration

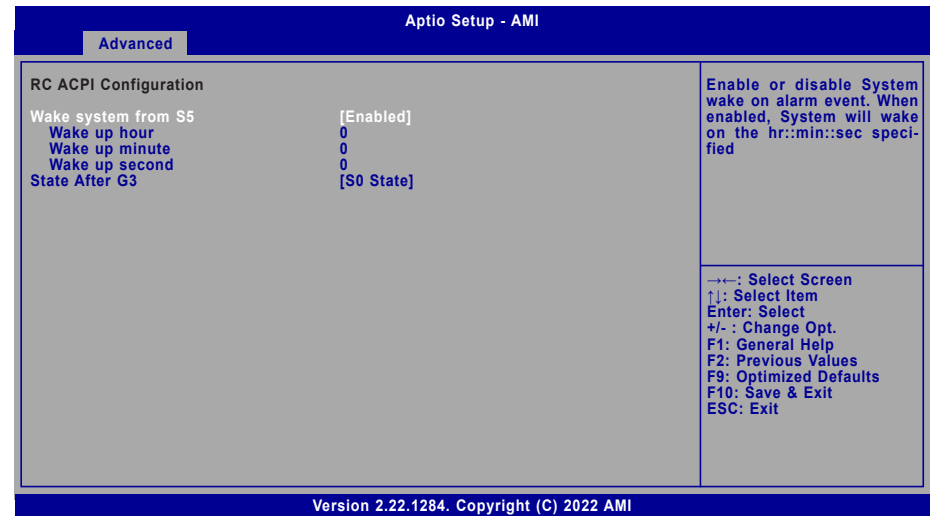

### Wake system from S5

When Enabled, the system will automatically power up at a designated time every day. Once it's switched to [Enabled], please set up the time of day — hour, minute, and second — for the system to wake up.

### State After G3

Select between S0 State, and S5 State. This field is used to specify what state the system is set to return to when power is re-applied after a power failure (G3 state).

### S0 State **AT mode (Default)**

The system automatically powers on after power failure.

### S5 State **ATX mode**

The system enter soft-off state after power failure. Power-on signal input is required to power up the system.

▶ **Advanced**

**USB Configuration**

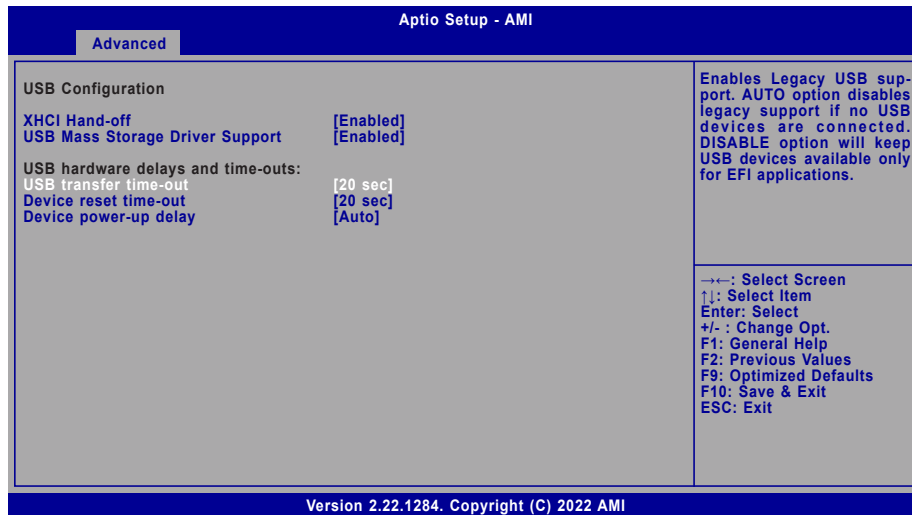

**XHCI Hand-off**

Enable or disable XHCI Hand-off.

**USB Mass Storage Driver Support**

Enable or disable USB Mass Storage Driver Support.

**USB transfer time-out**

The time-out value for Control, Bulk, and Interrupt transfers: 1,5,10,20 secs.

**Device reset time-out**

USB mass storage device Start Unit command time-out: 10,20,30, 40 secs.

**Device power-up delay**

Maximum time the device will take before it properly reports itself to the Host Controller.

'Auto' uses default value: for a Root port it is 100 ms, for a Hub port the delay is taken from Hub descriptor.

► Advanced

Network Stack Configuration

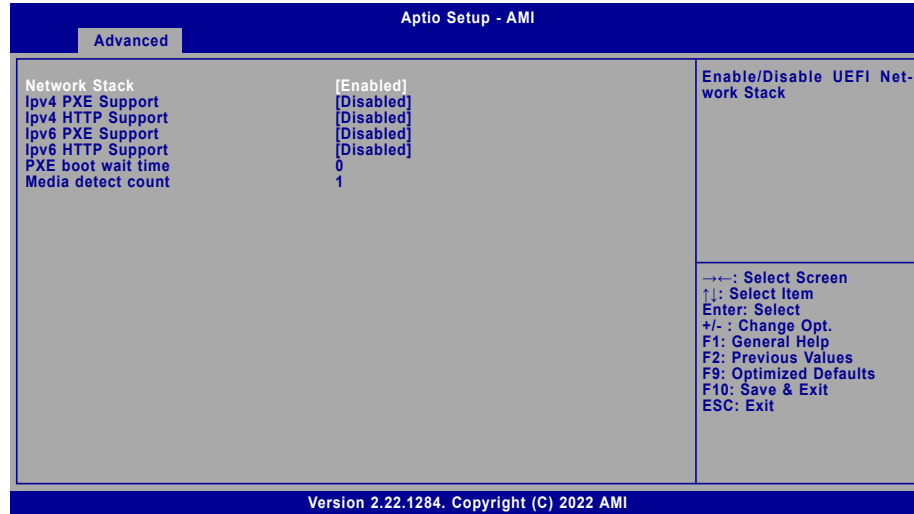

**Network Stack**

Enable or disable UEFI network stack. The following fields will appear when this field is enabled.

**Ipv4 PXE/HTTP Support**

Enable or disable IPv4 PXE/HTTP boot support. If disabled, IPv4 PXE/HTTP boot support will not be available.

**Ipv6 PXE/HTTP Support**

Enable or disable IPv6 PXE/HTTP boot support. If disabled, IPv6 PXE/HTTP boot support will not be available.

**PXE boot wait time**

Set the wait time in seconds to press ESC key to abort the PXE boot. Use either +/- or numeric keys to set the value.

**Media detect count**

Set the number of times the presence of media will be checked. Use either +/- or numeric keys to set the value.

► Advanced

DFI WDT Configuration

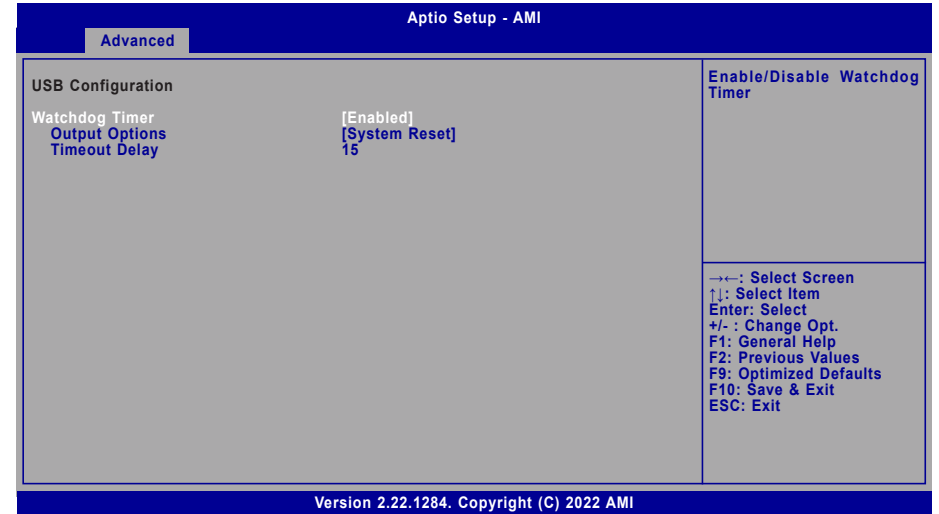

**Watchdog Timer**

Enable or disable Watchdog Timer.

**Output Options**

Select the Output Options: System Reset or Generate NMI.

**Timeout Delay**

The Timeout delay allows time for period of the watchdog timer. The unit is minute.

▶ Advanced

### USB Power Control

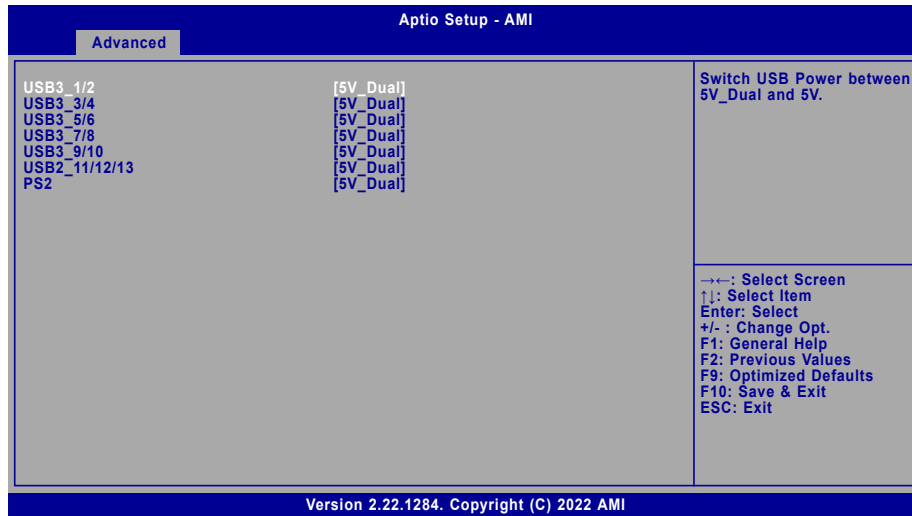

#### USB Power Switch

Switch USB Power between 5V\_Dual and 5V.

► Chipset

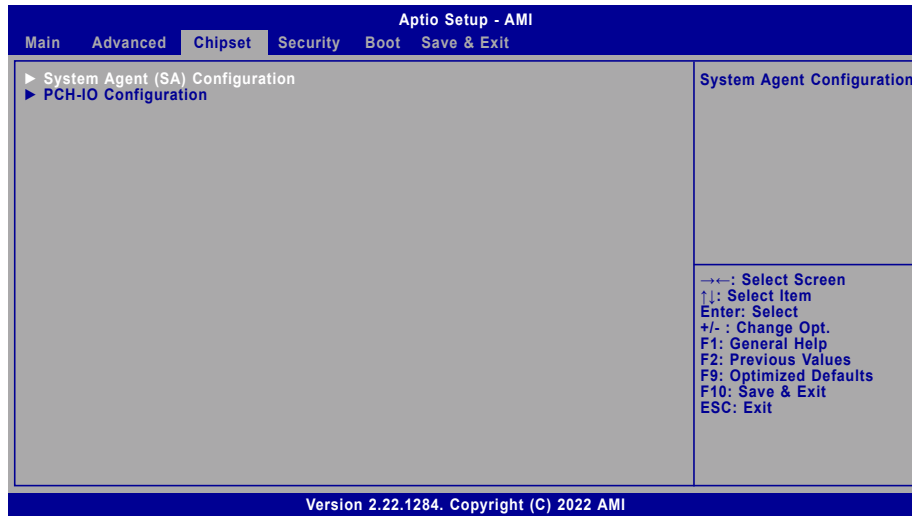

Please select a submenu and press Enter. The submenus are detailed in the following pages.

► Chipset ► System Agent (SA) Configuration

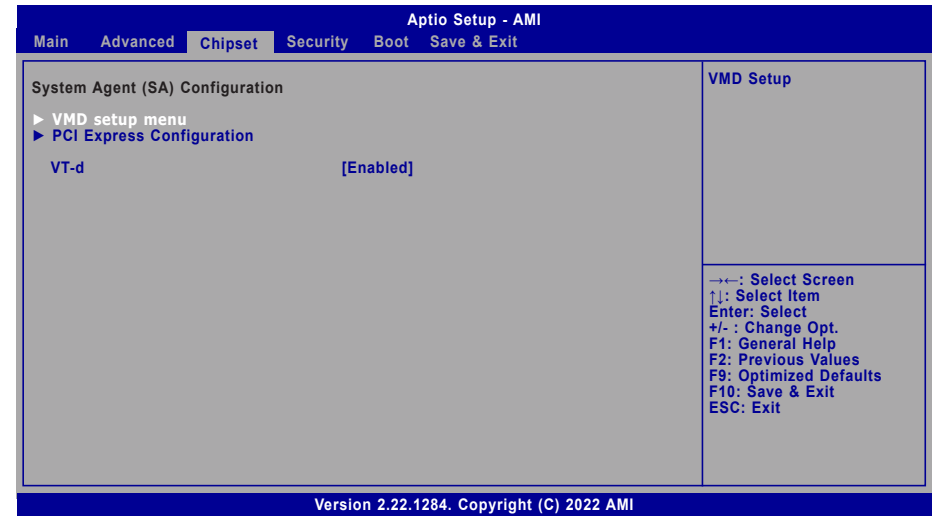

► VMD setup menu

VMD Configuration settings.

► PCI Express Configuration

PCI Express Configuration settings.

VT-d

Disable or enable VT-d.

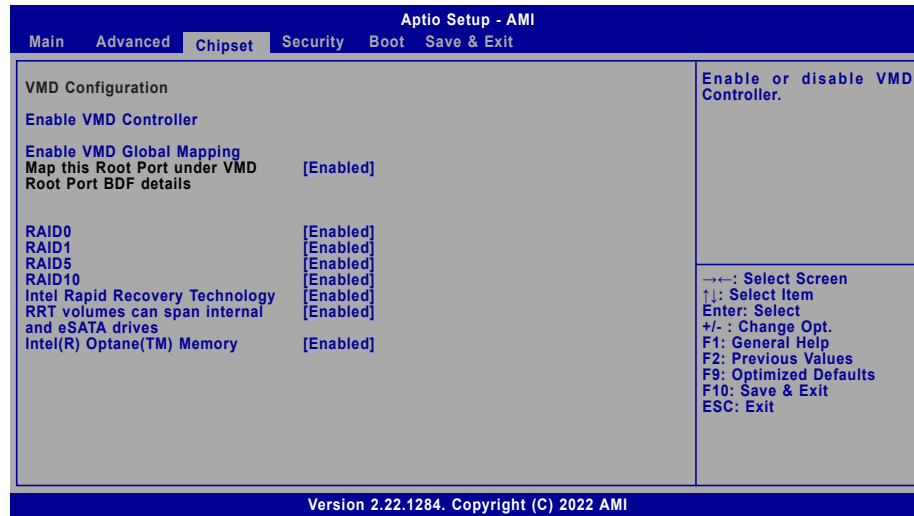

#### Enable VMD controller

Enable/Disable VMD controller.

#### Enable VMD Global Mapping

Enable/Disable VMD global mapping.

#### RAID 0,1,5,10

Enable or disable RAID 0,1,5,10.

#### Intel Rapid Recovery Technology

Enable or disable Intel Rapid Recovery Technology.

#### RRT volumes can span internal and eSATA drives

Enable or disable RRT volumes can span internal and eSATA drives.

#### Intel(R) Optane(TM) Memory

Enable or disable Intel(R) Optane(TM) Memory.

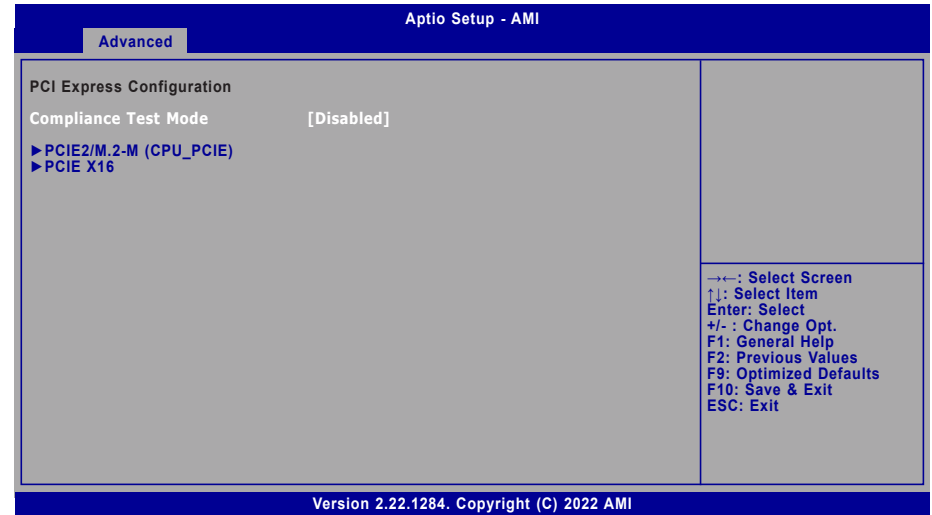

#### Compliance Test Mode

Enable when using Compliance Load Board.

#### PCIe2/M.2-M(CPU\_PCIE) / PCI-E X16

Configure PCIe ports, enable / disable or determine its speed.

► Chipset

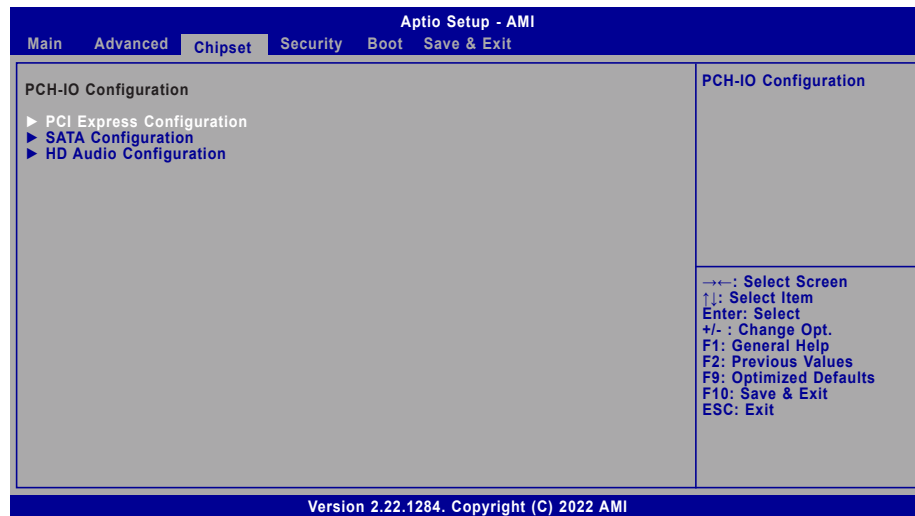

► PCI Express Configuration

- **LAN1/LAN2/M.2-E/10G\_LAN1/10G\_LAN2/PCIE3/PCIE4/PCIE5**  
Enable or disable the PCI Express Root Port. The following fields are only available when the PCIe root port is enabled.
  - **PCIe Speed**  
Select PCIe Speed of the current port – AUTO, Gen1, Gen 2, or Gen3. This field may not appear when the speed of the port is not configurable.
  - **Hot Plug**  
Enable or disable hot plug function of the port. This field may not appear when the port does not support hot plug.
  - **Detect Non-Compliance Device**  
Enable or disable this field to detect non-compliance PCIe devices in the PEG. This field may not appear when the port does not support Non-compliant device detection.

► SATA Configuration

See next page.

► HD Audio Configuration

Enable or disable HD Audio.

► Chipset ► PCH-IO Configuration

SATA Configuration

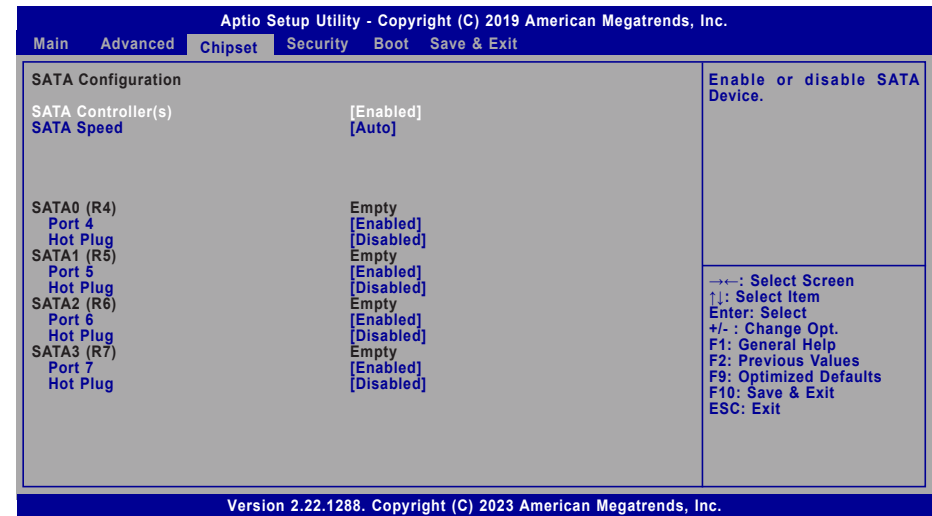

**SATA Controller(s)**

This field is used to enable or disable the Serial ATA controller.

**SATA Speed**

This field is used to select SATA speed generation limit: Auto, Gen1, Gen2 or Gen3.

**Ports and Hot Plug**

Enable or disable the Serial ATA port and its hot plug function.

► Security

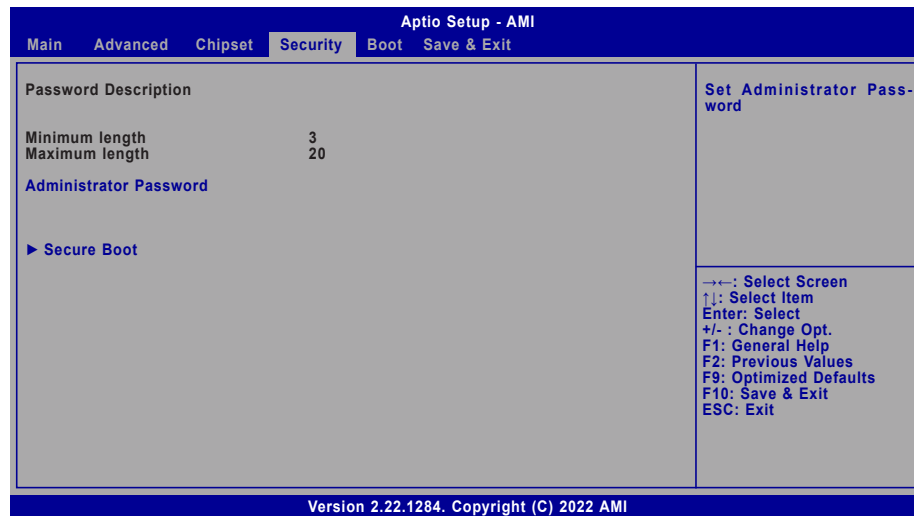

**Administrator Password**

Set the administrator password. To clear the password, input nothing and press enter when a new password is asked. Administrator Password will be required when entering the BIOS.

**User Password**

Set the user password. To clear the password, input nothing and press enter when a new password is asked. User Password will be required when powering up the system.

► Security

Secure Boot

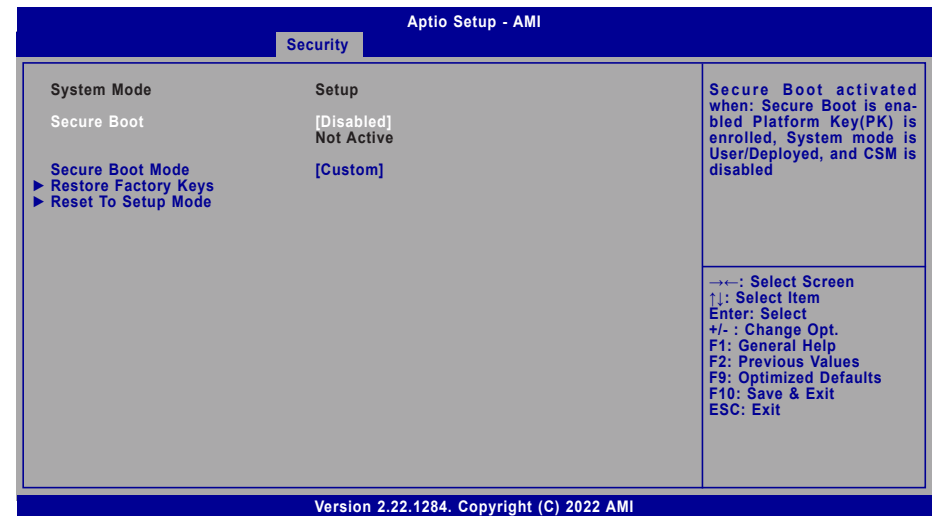

**Secure Boot**

The Secure Boot store a database of certificates in the firmware and only allows the OSeS with authorized signatures to boot on the system. To activate Secure Boot, please make sure that "Secure Boot" is "[Enabled]", Platform Key (PK) is enrolled, "System Mode" is "User", and CSM is disabled. After enabling/disabling Secure Boot, please save the configuration and restart the system. When configured and activated correctly, the Secure Boot status will be "Active".

**Secure Boot Customization**

Select the secure boot mode – Standard or Custom. When set to Custom, the following fields will be configurable for the user to manually modify the key database.

**Restore Factory Keys**

Force system to User Mode. Load OEM-defined factory defaults of keys and databases onto the Secure Boot. Press Enter and a prompt will show up for you to confirm.

**Reset To Setup Mode**

Clear the database from the NVRAM, including all the keys and signatures installed in the Key Management menu. Press Enter and a prompt will show up for you to confirm.

► **Boot**

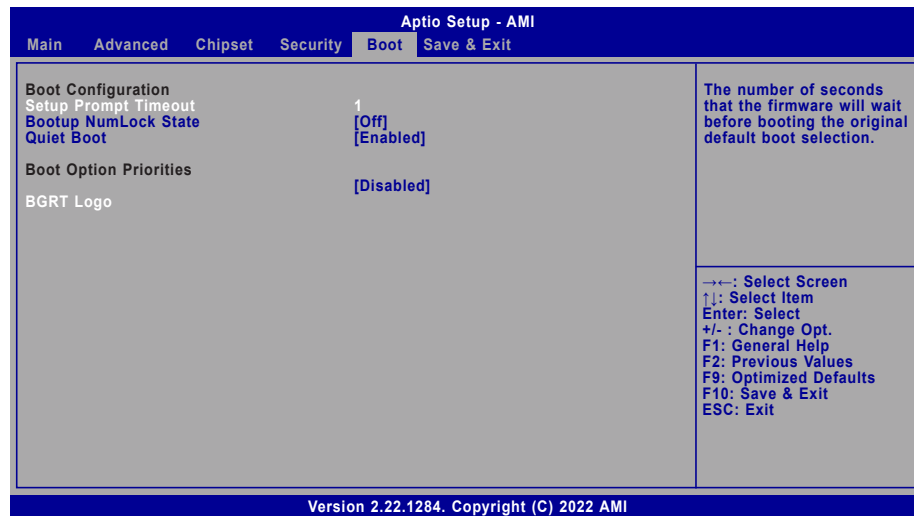

**Setup Prompt Timeout**

Set the number of seconds to wait for the setup activation key. 65535 (0xFFFF) denotes indefinite waiting.

**Bootup NumLock State**

Select the keyboard NumLock state: On or Off.

**Quiet Boot**

This section is used to enable or disable quiet boot option.

**Boot Option Priorities**

Rearrange the system boot order of available boot devices.

**Fast Boot**

Enable or disable fast boot.

► **Save & Exit**

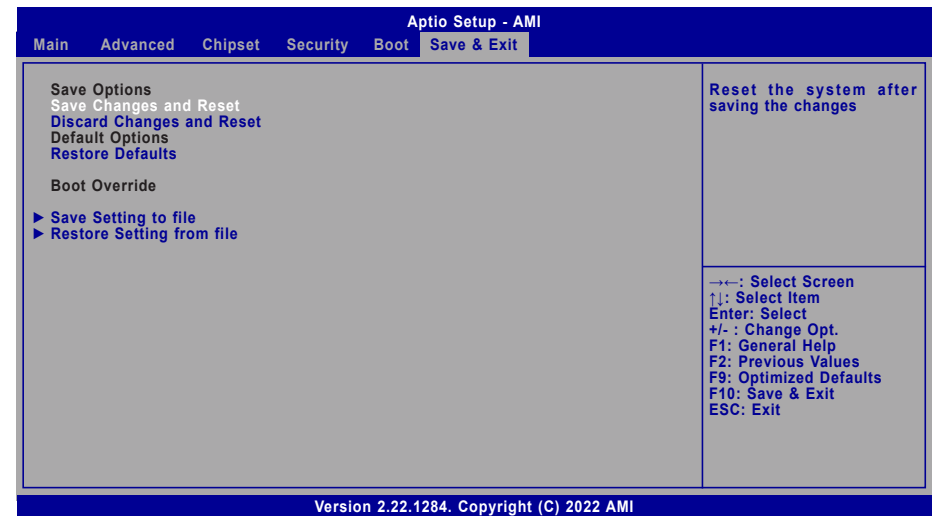

**Save Changes and Reset**

To save the changes, select this field and then press <Enter>. A dialog box will appear. Select Yes to reset the system after saving all changes made.

**Discard Changes and Reset**

To discard the changes, select this field and then press <Enter>. A dialog box will appear. Select Yes to reset the system setup without saving any changes.

**Restore Defaults**

To restore and load the optimized default values, select this field and then press <Enter>. A dialog box will appear. Select Yes to restore the default values of all the setup options.

**Boot Override**

Move the cursor to an available boot device and press Enter, and then the system will immediately boot from the selected boot device. The Boot Override function will only be effective for the current boot. The "Boot Option Priorities" configured in the Boot menu will not be changed.

► **Save Setting to file**

Select this option to save BIOS configuration settings to a USB flash device.

► **Restore Setting from file**

This field will appear only when a USB flash device is detected. Select this field to restore setting from the USB flash device.

## ► Updating the BIOS

To update the BIOS, you will need the new BIOS file and a flash utility. Please contact technical support or your sales representative for the files and specific instructions about how to update BIOS with the flash utility. For updating AMI BIOS in UEFI mode, you may refer to the how-to video at <https://www.dfi.com/Knowledge/Video/5>.

## ► Notice: BIOS SPI ROM

1. The Intel® Management Engine has already been integrated into this system board. Due to the safety concerns, the BIOS (SPI ROM) chip cannot be removed from this system board and used on another system board of the same model.
2. The BIOS (SPI ROM) on this system board must be the original equipment from the factory and cannot be used to replace one which has been utilized on other system boards.
3. If you do not follow the methods above, the Intel® Management Engine will not be updated and will cease to be effective.



**Note:**

- a. You can take advantage of flash tools to update the default configuration of the BIOS (SPI ROM) to the latest version anytime.
- b. When the BIOS IC needs to be replaced, you have to populate it properly onto the system board after the EEPROM programmer has been burned and follow the technical person's instructions to confirm that the MAC address should be burned or not.

## Chapter 4 - RAID Settings

The system board allows configuring RAID on Serial ATA drives. It supports RAID 0, RAID 1, RAID 5 and RAID 10.

### ► RAID Levels

#### RAID 0 (Striped Disk Array without Fault Tolerance)

RAID 0 uses two new identical hard disk drives to read and write data in parallel, interleaved-stacks. Data is divided into stripes and each stripe is written alternately between two disk drives. This improves the I/O performance of the drives at different channel; however it is not fault tolerant. A failed disk will result in data loss in the disk array.

#### RAID 1 (Mirroring Disk Array with Fault Tolerance)

RAID 1 copies and maintains an identical image of the data from one drive to the other drive. If a drive fails to function, the disk array management software directs all applications to the other drive since it contains a complete copy of the drive's data. This enhances data protection and increases fault tolerance to the entire system. Use two new drives or an existing drive and a new drive but the size of the new drive must be the same or larger than the existing drive.

#### RAID 5

RAID 5 stripes data and parity information across hard drives. It is fault tolerant and provides better hard drive performance and more storage capacity.

#### RAID 10 (Mirroring and Striping)

RAID 10 is a combination of data striping and data mirroring providing the benefits of both RAID 0 and RAID 1. Use four new drives or an existing drive and three new drives for this configuration.

RAID Level	Min. Drives	Protection	Description
RAID 0	2	None	Data striping without redundancy
RAID 1	2	Single Drive Failure	Disk mirroring
RAID 5	3	Single Drive Failure	Block-level data striping with distributed parity
RAID 10	4	1 Disk Per Mirrored Stripe (not same mirror)	Combination of RAID 0 (data striping) and RAID 1 (mirroring)



**Note:**

M.2 PCIe SSD cannot be used to set up a RAID set either with an M.2 SATA SSD or a SATA hard drive.

### ► Setup Procedure

To enable the RAID function, the following settings are required.

1. Install SATA drives.
2. Enable RAID in the Insyde BIOS.
3. Create a RAID volume.
4. Install the Intel Rapid Storage Technology Utility.

#### Step 1: Install SATA Drives

Refer to chapter 2 for details on connecting the Serial ATA drives.



**Important:**

1. Please make sure the SATA drives that you are to create a RAID volume with are connected and powered, and are able to be detected by the system. Otherwise, the RAID BIOS utility would not be accessible.
2. While creating a RAID volume, please make sure the system, drives, and cables are perfectly steady and mounted correctly. Disturbance during creating a RAID

#### Step 2: Create a RAID Volume

1. Go to the "Advanced" menu of the AMI BIOS and select "Intel(R) Rapid Storage Technology".
2. The screen displays all available drives. Select "Create RAID volume" to create a RAID volume".
3. Use the up or down arrow keys to select the RAID level and press <Enter>.
4. Use the up or down arrow keys to scroll through the list of hard drives and press <Enter> to select the drive.
5. Press <Enter>.
6. Use the up or down arrow keys to select the strip size and press <Enter>.
7. Enter the volume size and press <Enter>.
8. At the prompt, press <Y> to confirm volume creation.

#### Step 3: Install the Intel Rapid Storage Technology Utility

The Intel Rapid Storage Technology Utility can be installed from within Windows. It allows RAID volume management (create, delete, migrate) from within the operating system. It will also display useful SATA device and RAID volume information. The user interface, tray icon service and monitor service allow you to monitor the current status of the RAID volume and/or SATA drives. It enables enhanced performance and power management for the storage sub-system.

► How to enable Intel(R) Rapid Storage Technology in BIOS

System Agent (SA) Configuration ► VMD Setup Menu

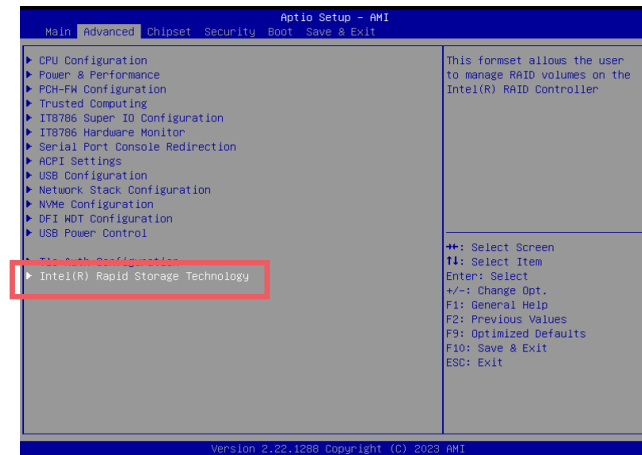
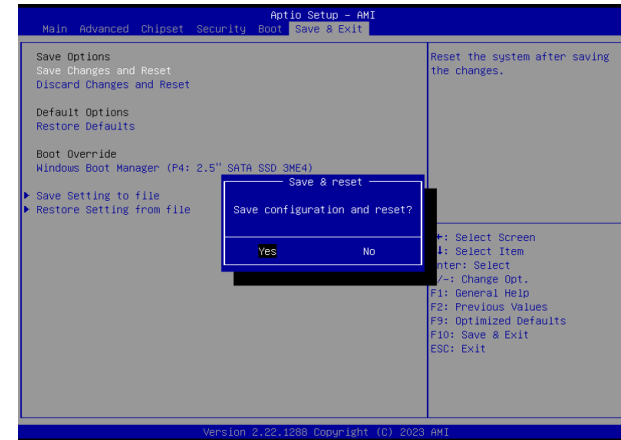
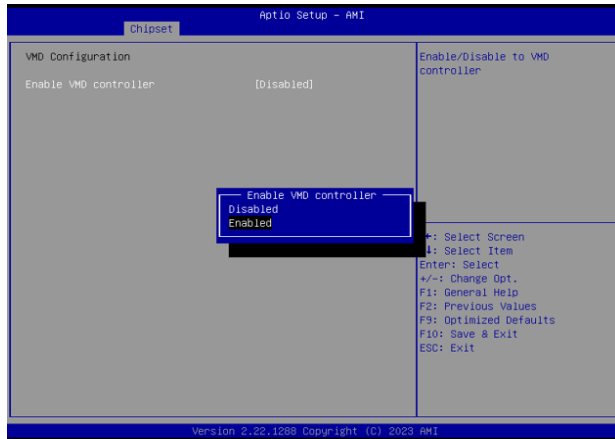

Enable VMD Controller for more options.

Save the changes and exit.

Locate Intel(R) Rapid Storage Technology option on Advanced menu.