

EC500-CS

Q370
H310
C246



8th/9th Gen Intel® Core™
Modular-Designed Embedded System



KEY FEATURES



DDR4

DDR4 SODIMM up to 64GB



Wide-Temperature

Operating temperature: -20 to 70°C



Three Independent Displays

1 VGA + 2 HDMI/DP++ (auto detection)

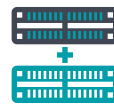

Multiple Expansion

3 M.2 slots (1 M.2 2230 E key, 1 M.2 3042/3052 B key, 1 M.2 2280 M key)

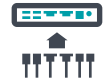

Rich I/O

2 GbE, 6 COM, 4 USB 3.1, 2 USB 2.0 (Q370/C246 only)



Support 5G Communication

Support 5G communication

PANEL

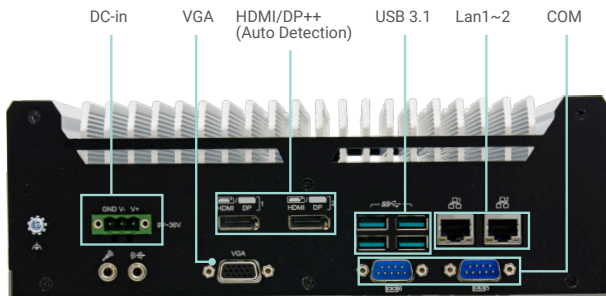

Front View

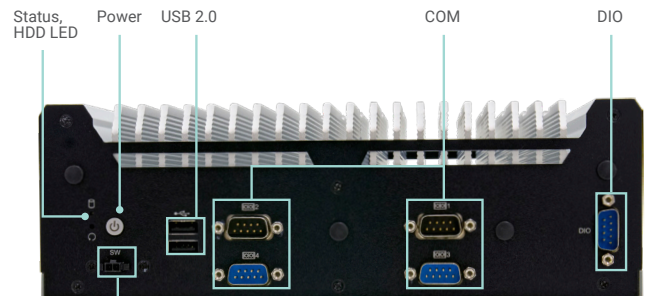

Rear View

DIMENSIONS

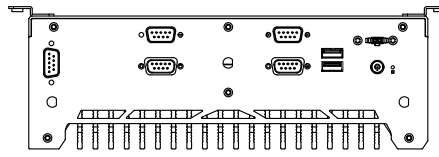

Front View

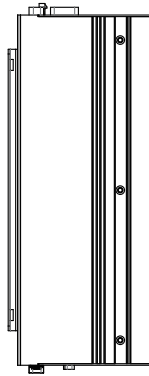

Left View

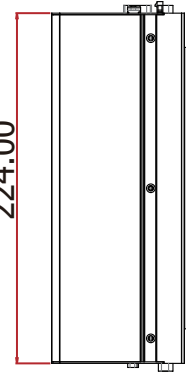
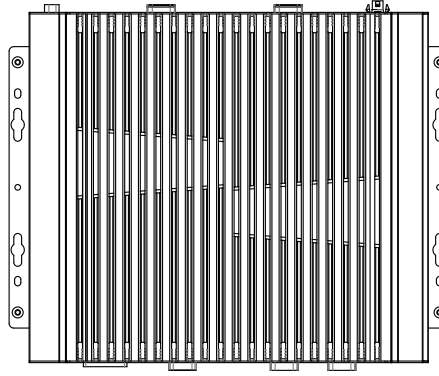

Right View

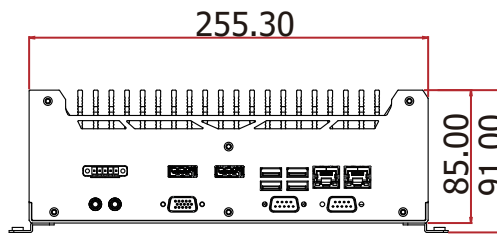

Rear View

WALL MOUNTING

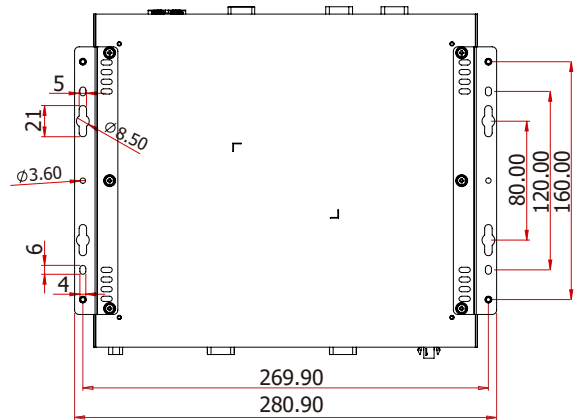
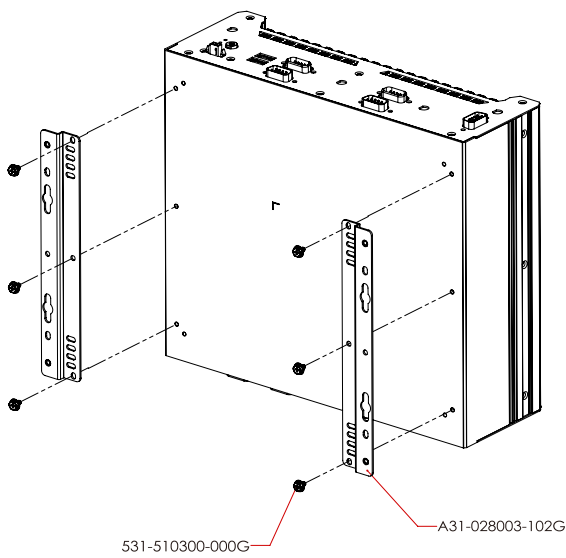

SPECIFICATION

SYSTEM	Processor	8th/9th Generation Intel® Core™ Processors, LGA 1151 Intel® Core™ i7-9700TE , Octa Cores, 12M Cache, up to 3.8 GHz, 35W Intel® Core™ i5-9500TE , Hexa Cores, 9M Cache, up to 3.6 GHz), 35W Intel® Core™ i3-9100TE, Quad Cores, 6M Cache, up to 3.2 GHz, 35W Intel® Core™ i7-8700T Processor, Hexa Core, 12M Cache, 2.4GHz (4GHz), 35W Intel® Core™ i5-8500T Processor, Hexa Core, 9M Cache, 2.1GHz (3.5GHz), 35W Intel® Core™ i3-8100T Processor, Quad Core, 6M Cache, 3.1GHz, 35W Intel® Pentium® Processor G5400T, Dual Core, 4M Cache, 3.1GHz, 35W Intel® Celeron® Processor G4900T, Dual Core, 2M Cache, 3.1GHz, 35W	
	Chipset	Intel® Q370/C246/H310 Chipset	
	Memory	Two 260-pin DDR4 2400/2666MHz SODIMM up to 64GB	
	BIOS	AMI SPI 128Mbit	
	GRAPHICS	Controller	Intel® HD Graphics
Feature		OpenGL up to 5.0, DirectX 11, OpenCL 2.1 HW Decode: HEVC/H.265, H.264, M/JPEG, MPEG2, VC1/WMV9, VP8 (8-bit), VP9 (10-bit) HW Encode: HEVC/H.265, M/JPEG, MPEG2, VP8	
Display		Q370/C246: 1 x VGA 2 x HDMI/DP++ (auto detection) H310: 1 x VGA 1 x HDMI/DP++ (auto detection)	VGA: resolution up to 1920x1200 @ 60Hz HDMI: resolution up to 4096x2160 @ 30Hz DP++: resolution up to 4096x2304 @ 60Hz
Dual/Triple Displays		Q370/C246: 1 x VGA + 2 x HDMI/DP++ (auto detection) H310: 1 x VGA + 1 x HDMI/DP++ (auto detection)	
STORAGE	Internal	2 x 2.5" SATA 3.0 Drive Bay support RAID 0/1 (for Q370/C246)	
EXPANSION	Interface	Q370/C246: 1 x M.2 2230 E key (PCIe/USB 2.0) 1 x M.2 2280 M key (PCIe x4 NVMe/SATA) 1 x M.2 3042/3052 B key (PCIe/USB3.0) H310: 1 x M.2 2230 E key (PCIe/USB 2.0) 1 x M.2 2280 M key (SATA) 1 x M.2 3042/3052 B key (PCIe)	
		Audio Codec	Realtek ALC888
ETHERNET	Controller	Q370/C246: 1 x Intel® I211AT PCIe (10/100/1000Mbps) 1 x Intel® I219LM with iAMT11.0 PCIe (10/100/1000Mbps) (only Core i7/i5 supports iAMT) H310: 1 x Intel® I211AT PCIe (10/100/1000Mbps) 1 x Intel® I219V PCIe (10/100/1000Mbps)	
LED	Indicators	1 x Status LED 1 x HDD LED	
FRONT I/O	Serial	4 x RS-232/422/485 (DB-9)	
	USB	2 x USB 2.0 (type A)	
	DIO	8 bit (DB-9)	
	Buttons	1 x Power button 1 x Reset button	
	Antenna	4 x Antenna hole	
REAR I/O	Ethernet	2 x GbE (RJ-45)	
	Serial	2 x RS-232 (DB-9)	
	USB	4 x USB 3.1 (type A)	
	Display	Q370/C246: VGA + 2 x HDMI/DP++ (auto detection) H310: VGA + 1 x HDMI/DP++ (auto detection)	
	Audio	1 x Line-out 1 x Mic-in	
WATCHDOG TIMER	Output & Interval	System reset, programmable via software from 1 to 255 seconds	
SECURITY	TPM	TPM 2.0	
POWER	Type	Wide range 9~36V	
	Connector	3-pole terminal nlock 3-pin power extension switch connector	
OS SUPPORT	Window	Windows 10 IoT Enterprise 64 Bit	
	Linux	Linux (available upon request)	

SPECIFICATION

MECHANISM	Construction	Metal + Aluminum
	Mounting	Wall Mount
	Dimensions (W x H x D)	255.3 x 85 x 224mm
	Weight	4.15 kg
ENVIRONMENT	Operating Temperature	-20 to 70°C (SSD or mSATA)
	Storage Temperature	-20 to 85°C
	Relative Humidity	5 to 95% RH (non-condensing)
STANDARDS AND CERTIFICATIONS	Shock	Half sine wave 3G, 11ms, 3 shock per axis
	Vibration	IEC68-2-64
	Certification	CE, FCC Class A, RoHS, UKCA, BIS

SYSTEM MODELS

P/N	750-EC5003-000G	750-EC5003-100G	750-EC5003-200G	750-EC5003-300G
MODEL NAME	EC500-CS4061-Q	EC500-CS4061-H	EC500-CS4061-C	EC500-CS4061-Q
CPU	i5-8500T	i5-8500T	i5-8500T	i7-8700T
PCH	Q370	H310	C246	Q370
M.2 SLOT	1 M.2 2230 E key 1 M.2 2280 M Key 1 M.2 3042/3052 B key	1 M.2 2230 E key 1 M.2 2280 M Key 1 M.2 3042/3052 B key	1 M.2 2230 E key 1 M.2 2280 M Key 1 M.2 3042/3052 B key	1 M.2 2230 E key 1 M.2 2280 M Key 1 M.2 3042/3052 B key
VIDEO OUTPUT	2 HDMI/DP 1 VGA	1 HDMI/DP 1 VGA	2 HDMI/DP 1 VGA	2 HDMI/DP 1 VGA
COM	6	6	6	6
USB3.1	4	4	4	4
USB2.0	2	2	2	2
LAN	2	2	2	2
DIO	8 bit	8 bit	8 bit	8 bit
REMOTE S/W	Yes	Yes	Yes	Yes
DC-IN	9V~36V	9V~36V	9V~36V	9V~36V

P/N	750-EC5003-400G	750-EC5003-500G	750-EC5003-600G
MODEL NAME	EC500-CS4061-Q	EC500-CS4061-H	EC500-CS4061-H
CPU	-	-	i7-8700T
PCH	Q370	H310	H310
M.2 SLOT	1 M.2 2230 E key 1 M.2 2280 M Key 1 M.2 3042/3052 B key	1 M.2 2230 E key 1 M.2 2280 M Key 1 M.2 3042/3052 B key	1 M.2 2230 E key 1 M.2 2280 M Key 1 M.2 3042/3052 B key
VIDEO OUTPUT	2 HDMI/DP 1 VGA	1 HDMI/DP 1 VGA	1 HDMI/DP 1 VGA
COM	6	6	6
USB3.1	4	4	4
USB2.0	2	2	2
LAN	2	2	2
DIO	8 bit	8 bit	8 bit
REMOTE S/W	Yes	Yes	Yes
DC-IN	9V~36V	9V~36V	9V~36V

ORDERING INFORMATION

Model Name	Part Number	Description
EC500-CS4061-Q	750-EC5003-000G	EC500-CS4061-Q:Fanless, CS263, Q370, CPU i5-8500T, 6 COM, 6 USB, 1 VGA, 2 HDMI/DP, 2 LAN, 1 Line-out, 1 Mic-in, 8 bits DIO, DC9~36V, F/G SYSTEM RoHS
EC500-CS4061-H	750-EC5003-100G	EC500-CS4061-H:Fanless, CS263, H310, CPU i5-8500T, 6 COM, 6 USB, 1 VGA, 1 HDMI/DP, 2 LAN, 1 Line-out, 1 Mic-in, 8 bits DIO, DC9~36V, F/G SYSTEM RoHS
EC500-CS4061-C	750-EC5003-200G	EC500-CS4061-C:Fanless, CS263, C246, CPU i5-8500T, 6 COM, 6 USB, 1 VGA, 2 HDMI/DP, 2 LAN, 1 Line-out, 1 Mic-in, 8 bits DIO, DC9~36V, F/G SYSTEM RoHS

PACKING LIST

1 EC500-CS system unit
1 M.2 slot & Mini-PCIe slot screws
1 terminal block 3 pole for DC input
1 cable with 2 wire stripped and tinned to DC jack