

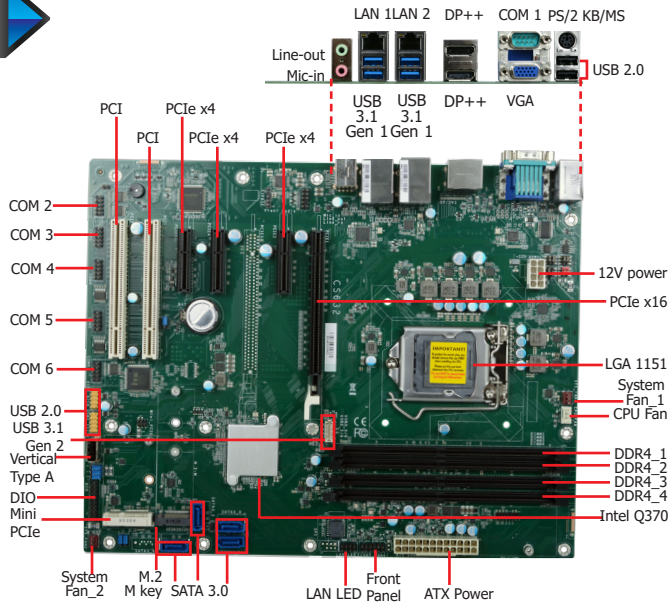

CS632-Q370

Desktop

Q370



Features

- 4 DDR4 DIMM up to 128GB
- 3 independent displays: VGA + DP++ + DP++
- DP++ resolution up to 4096x2160 @ 60Hz
- Multiple expansion: 1 PCIe x16 (x8/x8 signals as opt.), 3 PCIe x4, 2 PCI, 1 Mini PCIe, 1 M.2 M key, 1 SMBus, 1 LPC
- Rich I/O: 2 Intel GbE, 6 COM, 2 USB 3.1 Gen 2, 4 USB 3.1 Gen 1, 7 USB 2.0



2 Extension Modules for Additional 4 COM Ports (via the LPC connector)



Ordering Information

Model Name	P/N	Memory	GbE	RS-232/422/485	RS-232	USB3.1 Gen 2	USB3.1 Gen 1	USB 2.0	TPM 2.0	PCIe x16 slot	Power	Thermal	Temp.
CS632-Q370CRM	770-CS6321-100G	4 DIMM	2	2	4	2	4	7	0	1	24-pin ATX	Active	0 to 60°C
CS632-Q370CRM	770-CS6321-300G	4 DIMM	2	2	4	2	4	7	1	1	24-pin ATX	Active	0 to 60°C
CS632-Q370CRM	770-CS6321-500G	4 DIMM	2	2	4	2	4	7	0	2	24-pin ATX	Active	0 to 60°C

Mechanical Drawing

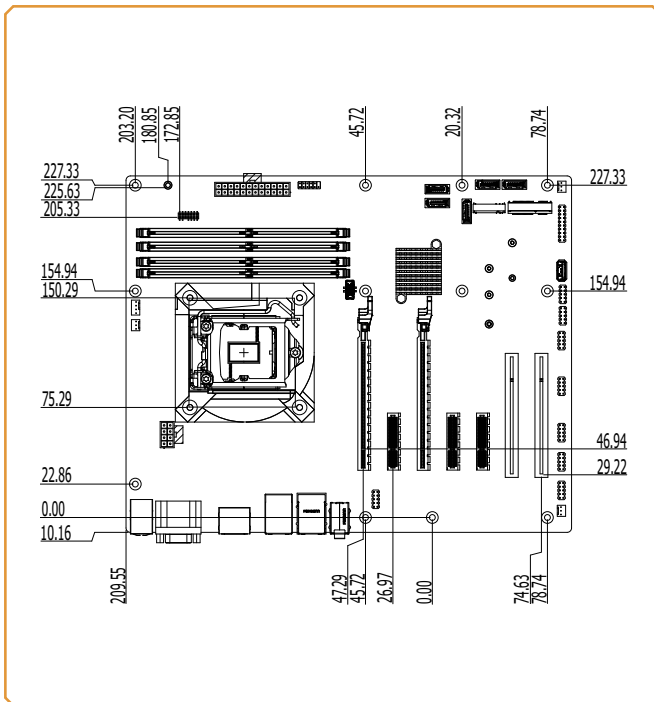

Block Diagram

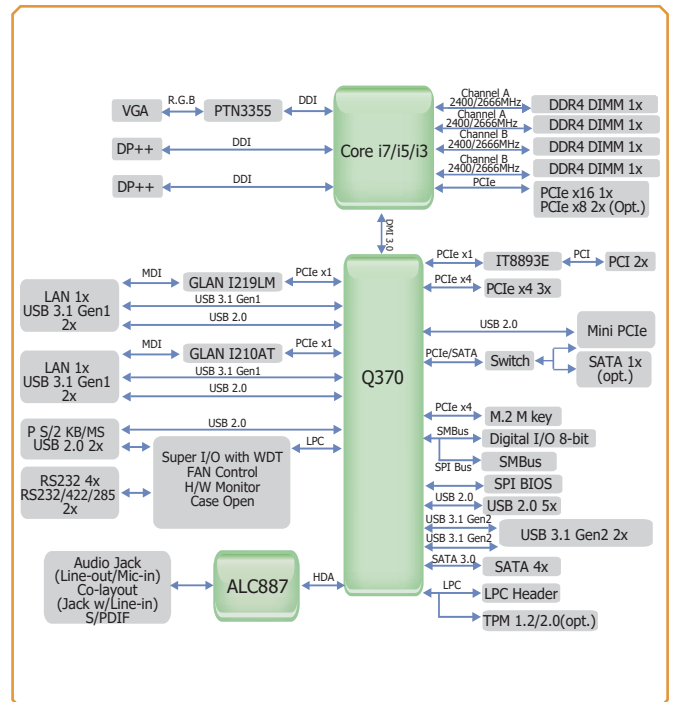

Specifications

SYSTEM	Processor	8th Generation Intel® Core™ /Pentium®/Celeron® LGA 1151 Socket Processors: Intel® Core™ i7-8700 (6 Cores, 12M Cache, up to 4.6 GHz); 65W Intel® Core™ i7-8700T (6 Cores, 12M Cache, up to 4.0 GHz); 35W Intel® Core™ i5-8500 (6 Cores, 9M Cache, up to 4.1 GHz); 65W Intel® Core™ i5-8500T (6 Cores, 9M Cache, up to 3.5 GHz); 35W Intel® Core™ i3-8100 (4 Cores, 6M Cache, 3.6 GHz); 65W Intel® Core™ i3-8100T (4 Cores, 6M Cache, to 3.1 GHz); 35W Intel® Pentium® G5400 (2 Cores, 4M Cache, 3.7 GHz); 58W Intel® Pentium® G5400T (2 Cores, 4M Cache, 3.1 GHz); 35W Intel® Celeron® G4900 (2 Cores, 2M Cache, 3.1 GHz); 54W Intel® Celeron® G4900T (2 Cores, 2M Cache, 2.9 GHz); 35W 9th Generation Intel® Core™ LGA 1151 Socket Processors: Intel® Core™ i7-9700TE (8 Cores, 12M Cache, up to 3.8 GHz); 35W Intel® Core™ i5-9500E (6 Cores, 9M Cache, up to 4.2 GHz); 65W Intel® Core™ i5-9500TE (6 Cores, 9M Cache, up to 3.6 GHz); 35W Intel® Core™ i3-9100E (4 Cores, 6M Cache, 3.7 GHz); 65W Intel® Core™ i3-9100TE (4 Cores, 6M Cache, to 3.2 GHz); 35W	
	Chipset	Intel® Q370 Chipset	
	Memory	Four 288-pin DIMM up to 128GB	Dual Channel DDR4 2400/2666MHz
	BIOS	SPI 128Mbit	
	GRAPHICS	Controller	Intel® HD Gen 9 Graphics
	Feature	OpenGL 5.0, DirectX 12, OpenCL 2.1 HW Decode: AVC/H.264, MPEG2, VC1/WMV9, JPEG/MJPEG, HEVC/H265, VP8, VP9 HW Encode: MPEG2, AVC/H264, JPEG, HEVC/H265, VP8, VP9	
	Display	1 x VGA 2 x DP++	VGA: resolution up to 1920x1200 @ 60Hz DP++: resolution up to 4096x2160 @ 60Hz
	Triple Displays	VGA + DP++ + DP++	
	EXPANSION	Interface	1 x PCIe x16 (Gen 3) (x8/x8 signals as opt., MOQ required) 3 x PCIe x4 (Gen 3) 2 x PCI 1 x Mini PCIe (PCIe/mSATA, share w/SATA conn. as opt./USB2.0) 1 x M.2 2242/2280 M key (PCIe x4 NVMe, Intel Optane Memory Support)
AUDIO	Audio Codec	Realtek ALC887 (ALC888 as opt.)	
ETHERNET	Controller	1 x Intel® I210AT PCIe (10/100/1000Mbps) 1 x Intel® I219LM PCIe with iAMT12.0 (10/100/1000Mbps) (only Core i7/i5 supports iAMT)	
REAR I/O	Ethernet	2 x GbE (RJ-45)	
	USB	4 x USB 3.1 Gen1	2 x USB 2.0
	Serial	1 x RS-232/422/485 (RS-232 w/ power) (DB-9)	
	PS/2	1 x PS/2 (mini-DIN-6)	
	Display	1 x VGA	2 x DP++
	Audio	1 x Line-out, 1 x Mic-in, 1 x Line-in (opt., MOQ required)	
INTERNAL I/O	Serial	5 x RS-232 (2.54mm pitch)	
	USB	2 x USB 3.1 Gen 2 (2.00mm pitch) 5 x USB 2.0 (2.54mm pitch) (4 x Pin Header, 1 x USB 2.0 colay vertical Type A)	
	Audio	1 x S/PDIF, 1 x Front Audio Header	
	SATA	4 x SATA 3.0	RAID 0/1/5/10
	DIO	1 x 8-bit DIO	
	LPC	1 x LPC (supports LPC EXT-RS232/RS485 module)	
	SMBus	1 x SMBus	
	WATCHDOG TIMER	Output & Interval	System Reset, Programmable via Software from 1 to 255 Seconds
SECURITY	TPM	Infineon TPM1.2/2.0 (opt., MOQ required)	
POWER	Type	ATX	
	Connector	8-pin ATX 12V power	24-pin ATX power
	Consumption	Typical: i7-8700K: 3.3V @ 0.35A (1.155Watt); 5V @ 0.62A (3.1Watt); 12V @ 0.54A (6.48Watt) Max.: i7-8700K: 3.3V @ 0.35A (1.155Watt); 5V @ 1.35A (6.75Watt); 12V @ 12.3A (147.6Watt)	
	RTC Battery	CR2032 Coin Cell	
OS SUPPORT		Windows 10 IoT Enterprise 64-bit	Linux
ENVIRONMENT	Temperature	Operating: 0 to 60°C Storage: -30 to 60°C with RTC Battery; -40 to 85°C without RTC Battery	
	Humidity	Operating: 5 to 90% RH	Storage: 5 to 90% RH
	MTBF	582,202 hrs @ 25°C; 332,716 hrs @ 45°C; 207,812 hrs @ 60°C Calculation model: Telcordia Issue 4 Environment: GB, GC – Ground Benign, Controlled	
MECHANICAL	Dimensions	ATX Form Factor	305mm (12") x 244mm (9.6")
	Height	PCB: 1.6mm	Top Side: 38.5mm Bottom Side: 4.4mm
CERTIFICATIONS		CE, FCC Class B, RoHS	

Packing List

• 1 CS632-Q370 motherboard	
• 1 Serial ATA data cable (Length: 500mm)	332-553001-005G
• 1 I/O shield	A49-CS6310-000G
• 1 M.2 2242/half mini PCIe standoff	A33-725019-090G
• 1 M.2 screw	A32-112016-041G
• 1 mini PCIe screw	A32-112016-041G

Optional Items

• USB 2.0 port cable (Length: 350mm)	A81-001066-016G
• USB 3.1 Gen2 port cable (Length: 300mm)	A81-001075-017G
• COM port cable (Length: 300mm, 2 x COM ports)	A81-015026-023G
• Serial ATA data cable (Length: 500mm, W/LOCK)	332-553001-005G
• Thermal solution (For 35W, Height: 37.3mm)	A71-101107-000G
• Thermal solution (For 65W, Height: 74.47mm)	A71-101158-000G
• Thermal solution (For 95W, Height: 77.2mm)	761-103001-000G
• LPC EXT-RS232 module (4 x RS232 ports)	770-EXTRS1-000G
• LPC EXT-RS485 module (4 x RS485 ports)	770-EXTRS1-100G
• DP to HDMI dongle	612-D2H13M-000G