

# CMS100

Mini-ITX

User's Manual

## Copyright

This publication contains information that is protected by copyright. No part of it may be reproduced in any form or by any means or used to make any transformation/adaptation without the prior written permission from the copyright holders.

This publication is provided for informational purposes only. The manufacturer makes no representations or warranties with respect to the contents or use of this manual and specifically disclaims any express or implied warranties of merchantability or fitness for any particular purpose. The user will assume the entire risk of the use or the results of the use of this document. Further, the manufacturer reserves the right to revise this publication and make changes to its contents at any time, without obligation to notify any person or entity of such revisions or changes.

Changes after the publication's first release will be based on the product's revision. The website will always provide the most updated information.

© 2023. All Rights Reserved.

## Trademarks

Product names or trademarks appearing in this manual are for identification purpose only and are the properties of the respective owners.

## FCC and DOC Statement on Class A

This equipment has been tested and found to comply with the limits for a Class A digital device, pursuant to Part 15 of the FCC rules. These limits are designed to provide reasonable protection against harmful interference when the equipment is operated in a residential installation. This equipment generates, uses and can radiate radio frequency energy and, if not installed and used in accordance with the instruction manual, may cause harmful interference to radio communications. However, there is no guarantee that interference will not occur in a particular installation. If this equipment does cause harmful interference to radio or television reception, which can be determined by turning the equipment off and on, the user is encouraged to try to correct the interference by one or more of the following measures:

- Reorient or relocate the receiving antenna.
- Increase the separation between the equipment and the receiver.
- Connect the equipment into an outlet on a circuit different from that to which the receiver is connected.
- Consult the dealer or an experienced radio TV technician for help.

## Notice:

1. The changes or modifications not expressly approved by the party responsible for compliance could void the user's authority to operate the equipment.
2. Shielded interface cables must be used in order to comply with the emission limits.

# Table of Contents

Chapter 1 - Introduction.....	6
Specifications .....	6
Dimensions .....	9
Block Diagram .....	9
Chapter 2 - Hardware Installations.....	10
Overview.....	10
Top View.....	10
Bottom View.....	10
Jumper Settings .....	11
Panel Power Selection (DPJP603) .....	11
Clear CMOS (JP1) .....	11
Backlight Voltage Select (DPJP601).....	12
Inverter Power Voltage Select (DPJP602).....	12
AT / ATX mode select (JP26).....	13
USB Power Select (DPJP604).....	13
Pin Assignment .....	14
Front Audio (AUJ2).....	14
USB2_11/12 (UBJ7).....	14
USB2_7/8 (UBJ8).....	15
CPU Fan (J10).....	15
System Fan (J9) .....	16
Battery (J5) .....	16
Backlight Control (DPJ601) .....	17
DIO Power (J12) .....	17
DIO (J13) .....	18
Front Panel (J11).....	18
LPC Debugger (J14).....	19
eDP (CN23).....	20
Expansion Slots.....	21
Installing the M.2 Module .....	21
Installing the SO-DIMM Module .....	22
Chapter 3 - BIOS Settings.....	23
Overview .....	23
Main.....	24
Advanced .....	24
RC ACPI Settings .....	25
CPU Configuration.....	25
Power & Performance .....	26
PCH-FW Configuration .....	26
Trusted Computing.....	27
PTN3460 Configuration .....	27
NCT6126D Super IO Configuration .....	28
NCT6126D HW Monitor .....	29
NCT6126D HW Monitor ▶ <b>Smart FAN Function</b> .....	<b>29</b>
Serial Port Console Redirection .....	30
Serial Port Console Redirection ▶ <b>Console Redirection Settings</b> .....	<b>30</b>
USB Configuration .....	31
Network Stack Configuration.....	31
CSM Configuration .....	32
USB Power Control.....	32

Chipset .....	33
Graphics Configuration .....	33
PEG Port Configuration.....	34
PCH-IO Configuration.....	34
PCH-IO Configuration ▶ <b>PCI Express Configuration</b> .....	<b>35</b>
PCH-IO Configuration ▶ <b>SATA And RST Configuration</b> .....	<b>36</b>
PCH-IO Configuration ▶ <b>HD Audio Configuration</b> .....	<b>36</b>
Security .....	37
Secure Boot.....	37
Boot .....	38
Save & Exit .....	38
Updating the BIOS .....	39
Notice: BIOS SPI ROM.....	39

## About this Manual

This manual can be retrieved from the website.

The manual is subject to change and update without notice, and may be based on editions that do not resemble your actual products. Please visit our website or contact our sales representatives for the latest editions.

## Warranty

1. Warranty does not cover damages or failures that arises from misuse of the product, inability to use the product, unauthorized replacement or alteration of components and product specifications.
2. The warranty is void if the product has been subjected to physical abuse, improper installation, modification, accidents or unauthorized repair of the product.
3. Unless otherwise instructed in this user's manual, the user may not, under any circumstances, attempt to perform service, adjustments or repairs on the product, whether in or out of warranty. It must be returned to the purchase point, factory or authorized service agency for all such work.
4. We will not be liable for any indirect, special, incidental or consequential damages to the product that has been modified or altered.

## About this Package

The package contains the following items. If any of these items are missing or damaged, please contact your dealer or sales representative for assistance.

- 1 CMS100 motherboard
- 1 Serial ATA data cable w/lock (Length: 500mm)
- 1 COM port cable (Length: 250mm, 1 x COM port)
- 1 I/O shield
  - w/ icon DVI/DP/DP
  - w/ icon DVI/DP/HDMI

Note: The items are subject to change in the developing stage. The product and accessories in the package may not come similar to the information listed above. This may differ in accordance with the sales region or models in which it was sold. For more information about the standard package in your region, please contact your dealer or sales representative.

## Static Electricity Precautions

It is quite easy to inadvertently damage your PC, system board, components or devices even before installing them in your system unit. Static electrical discharge can damage computer components without causing any signs of physical damage. You must take extra care in handling them to ensure against electrostatic build-up.

1. To prevent electrostatic build-up, leave the system board in its anti-static bag until you are ready to install it.
2. Wear an antistatic wrist strap.
3. Do all preparation work on a static-free surface.
4. Hold the device only by its edges. Be careful not to touch any of the components, contacts or connections.
5. Avoid touching the pins or contacts on all modules and connectors. Hold modules or connectors by their ends.



### Important:

Electrostatic discharge (ESD) can damage your processor, disk drive and other components. Perform the upgrade instruction procedures described at an ESD workstation only. If such a station is not available, you can provide some ESD protection by wearing an antistatic wrist strap and attaching it to a metal part of the system chassis. If a wrist strap is unavailable, establish and maintain contact with the system chassis throughout any procedures requiring ESD protection.

## Safety Precautions

- Use the correct DC / AC input voltage range.
- Unplug the power cord before removing the system chassis cover for installation or servicing. After installation or servicing, cover the system chassis before plugging in the power cord.
- There is danger of explosion if battery incorrectly replaced.
- Replace only with the same or equivalent specifications of batteries recommend by the manufacturer.
- Dispose of used batteries according to local ordinance.
- Keep this system away from humid environments.
- Make sure the system is placed or mounted correctly and stably to prevent the chance of dropping or falling may cause damage.
- The openings on the system shall not be blocked and shall be kept in distance from

other objects to make sure of proper air ventilation to protect the system from overheating.

- Dress the cables, especially the power cord, so they will not be stepped on, in contact with high temperature surfaces, or cause any tripping hazards.
- Do not place anything on top of the power cord. Use a power cord that has been approved for use with the system and is compliant with the voltage and current ranges required by the system's electrical specifications.
- If the system is to be unused or stored for a long time, disconnect it from the power source to avoid damage by transient overvoltage.
- If one of the following occurs, consult a service personnel:
  - The power cord or plug is damaged.
  - Liquid has penetrated the system.
  - The system has been exposed to moisture.
  - The system is not working properly.
  - The system is physically damaged.
- The unit uses a three-wire ground cable which is equipped with a third pin to ground the unit and prevent electric shock. Do not defeat the purpose of this pin. If your outlet does not support this kind of plug, contact your electrician to replace the outlet.
- Disconnect the system from the electricity outlet before cleaning. Use a damp cloth for cleaning the surface. Do not use liquid or spray detergents for cleaning.
- Before connecting, make sure that the power supply voltage is correct. The device is connected to a power outlet which should be grounded connection.



The system may burn fingers while running.

Wait for 30 minutes to handle electronic parts after power off.

## Chapter 1 - Introduction

### ► Specifications

#### SYSTEM

10th Gen Intel® Xeon/Core™/Pentium/Celeron Processors, LGA 1200 Socket, TDP up to 125W  
 Intel® Xeon W-1290E Processor (Core 10; Max speed 4.8GHz; TDP 95W) (ECC memory supported) **(W480E only)\***  
 Intel® Xeon W-1270E Processor (Core 8; Max speed 4.8GHz; TDP 80W) (ECC memory supported)**(W480E only)\***  
 Intel® Xeon W-1250E Processor (Core 6; Max speed 4.7GHz; TDP 80W) (ECC memory supported)**(W480E only)**  
 Intel® Xeon W-1290TE Processor (Core 10; Max speed 4.5GHz; TDP 35W)**(W480E only)**  
 Intel® Xeon W-1270TE Processor (Core 8; Max speed 4.4GHz; TDP 35W)**(W480E only)**  
 Intel® Xeon W-1250TE Processor (Core 6; Max speed 3.8GHz; TDP 35W)**(W480E only)**  
 Intel® Core i9-10900E Processor (Core 10; Max speed 4.7GHz; TDP 65W)  
 Intel® Core i9-10900TE Processor (Core 10; Max speed 4.5GHz; TDP 35W)  
 Intel® Core i7-10700E Processor (Core 8; Max speed 4.5GHz; TDP 65W)  
 Intel® Core i7-10700TE Processor (Core 8; Max speed 4.4GHz; TDP 35W)  
 Intel® Core i5-10500E Processor (Core 6; Max speed 4.2GHz; TDP 65W)  
 Intel® Core i5-10500TE Processor (Core 6; Max speed 3.7GHz; TDP 35W)  
 Intel® Core i3-10100E Processor (Core 4; Max speed 3.8GHz; TDP 65W)  
 Intel® Core i3-10100TE Processor (Core 4; Max speed 3.6GHz; TDP 35W)  
 Intel® Pentium G6400E Processor (Core 2; Max speed 3.8GHz; TDP 65W)  
 Intel® Pentium G6400TE Processor (Core 2; Max speed 3.2GHz; TDP 35W)  
 Intel® Celeron G5900E Processor (Core 2; Max speed 3.2GHz; TDP 65W)  
 Intel® Celeron G5900TE Processor (Core 2; Max speed 3.0GHz; TDP 35W)  
**\*Note: 5-year life cycle support based on Intel IOTG roadmap.**

#### Processor

Chipset	Intel® W480E/Q470E/H420E Chipset
Memory	Two 260-pin SODIMM up to 64GB Dual Channel DDR4 2933MHz (ECC supported by W480E only)
BIOS	AMI SPI 256Mbit

#### GRAPHICS

Controller	Intel® HD Gen 9 Graphics
Feature	OpenGL 4.5, DirectX 12, OpenCL 2.1 HW Decode: AVC/H.264, MPEG2, VC1/WMV9, JPEG/MJPEG, HEVC/H265, VP8, VP9 HW Encode: AVC/H.264, MPEG2, JPEG, HEVC/H265, VP8, VP9
Display	1 x DP++ DP++: Resolution up to 4096x2304 @60Hz 1 x HDMI 1.4b/DP++ HDMI 1.4b: Resolution up to 4096x2160 @30Hz 1 x LVDS/eDP LVDS: resolution up to 1920x1200 @ 60Hz eDP: resolution up to 4096x2160 @ 60Hz 1 x DVI-I (DVI-D signal) DVI-I: resolution up to 1920x1200 @ 60Hz
Quad Displays	DP++ + DP++ + DVI-I + LVDS/eDP or DP++ + HDMI + DVI-I + LVDS/eDP

<b>EXPANSION</b>		1 x PCIe x16 (Gen 3) 1 x M.2 2230 E Key (PCIe x1/USB 2.0) 1 x M.2 2280 M Key (PCIe x4 Gen3 or SATA, H420E supports PCIe x1 signal only) 1 x M.2 2242/3042 B Key (W480E/Q470E: PCIe x1 Gen3 or SATA, USB 3.2 Gen1/USB 2.0) 1 x Nano SIM slot
	Interface	
<b>AUDIO</b>	Audio Codec	Realtek ALC888
<b>ETHERNET</b>		<b>W480E/Q470E:</b> 1 x Intel® I225LM PCIe(10/100/1000/2.5G speeds) 1 x Intel® I219LM PHY(10/100/1000 speeds), support vPro/AMT
	Controller	<b>H420E:</b> 1 x Intel® I225LM PCIe(10/100/1000/2.5G speeds) 1 x Intel® I219V PHY(10/100/1000 speeds)
<b>REAR I/O</b>	Ethernet	1 x 2.5GHz (RJ-45) 2 x GbE (RJ-45)
	Serial	2 x RS232/422/485 (DB-9)
	USB	<b>W480E/Q470E:</b> 6 x USB 3.2 Gen2 (dual type-A connector) <b>H420E:</b> 5 x USB 3.2 Gen1 + 1 x USB 2.0 (dual type-A connector)
	Display	1 x DP++ 1 x HDMI 1.4b or 1 x DP++ 1 x DVI-I
	Audio	1 x Front Audio (2.0mm pitch)
<b>INTERNAL I/O</b>	USB	<b>W480E/Q470E:</b> 4 x USB 2.0 (2.0mm pitch) <b>H420E:</b> 2 x USB 2.0 (2.0mm pitch)
	Display	1 x LVDS header 1 x eDP connector
	SATA	2 x SATA 3.0 (up to 6Gb/s) RAID 0/1/5/10 (w/ M.2 Key-M/B slot + 2 SATA Conn., <b>W480E/Q470E only</b> )
	DIO	1 x 8-bit DIO 1 x DIO Power
	LPC	1 x LPC
<b>WATCHDOG TIMER</b>	Output & Interval	System Reset, Programmable via Software from 1 to 255 Seconds
<b>SECURITY</b>	TPM	fTPM(Default); dTPM(Opt.)

<b>POWER</b>	Type	ATX
	Connector	8-pin ATX 12V power 24-pin ATX power
	Consumption	Idle: Intel Xeon W-1290E 95W: 12V @ 4.6A (55.2W) Max: Intel Xeon W-1290E 95W: 12V @ 11.6A (139.2W) Idle: Intel i9-10900K 125W: 12V @ 2A (24W) Max: Intel i9-10900K 125W: 12V @ 22A (264W)
	RTC Battery	CR2032 Coin Cell
<b>OS SUPPORT</b>	Microsoft	Windows 10 IoT Enterprise 64-bit
	Linux	Linux
<b>MECHANISM</b>	Dimensions	Mini-ITX Form Factor , 170mm (6.7") x 170mm (6.7")
	Height	PCB: 1.6mm Top Side: 31.51 mm Bottom Side: 4.4 mm
<b>ENVIRONMENT</b>	Temperature	Operating: -5 to 65°C Storage: -40 to 85°C
	Humidity	Operating: 5 to 90% RH Storage: 5 to 90% RH
	MTBF	CMS100-Q470: 591,713 hrs @ 25°C; 357,627 hrs @ 45°C ; 234,022 hrs @ 60°C Calculation model: Telcordia Issue 4 Environment: GB, GC – Ground Benign, Controlled
<b>CERTIFICATION</b>	Certification	CE, FCC, RoHS, UL, CB



► Dimensions

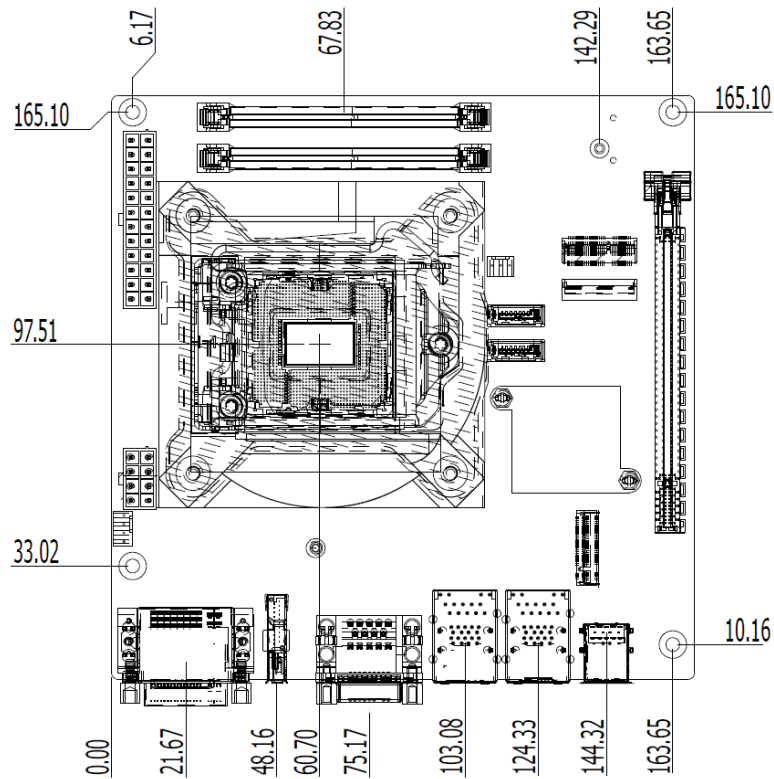

► Block Diagram

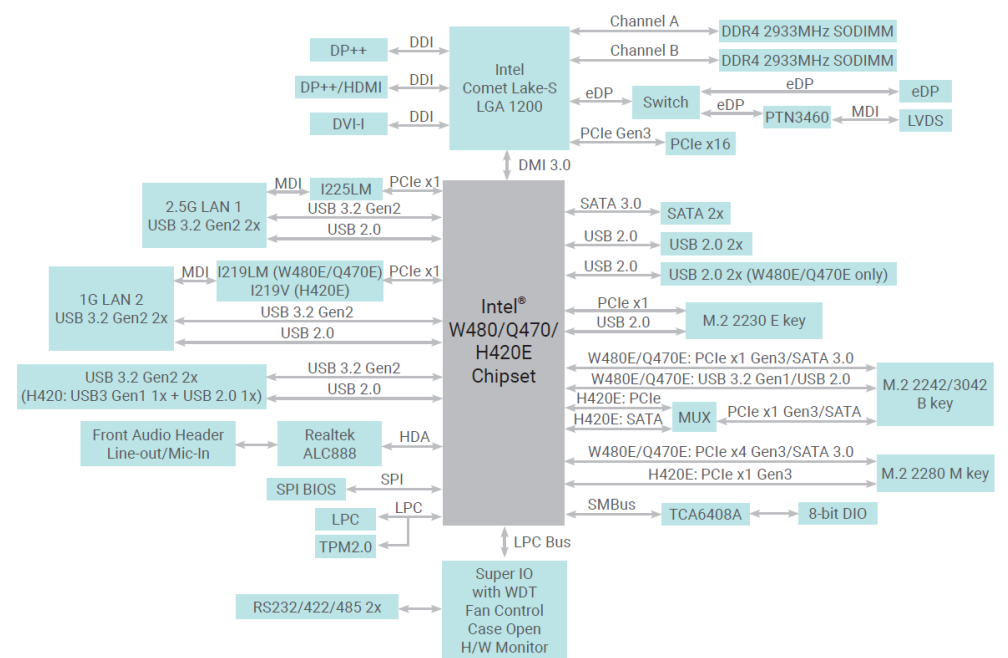

## Chapter 2 - Hardware Installations

### ► Overview

#### Top View

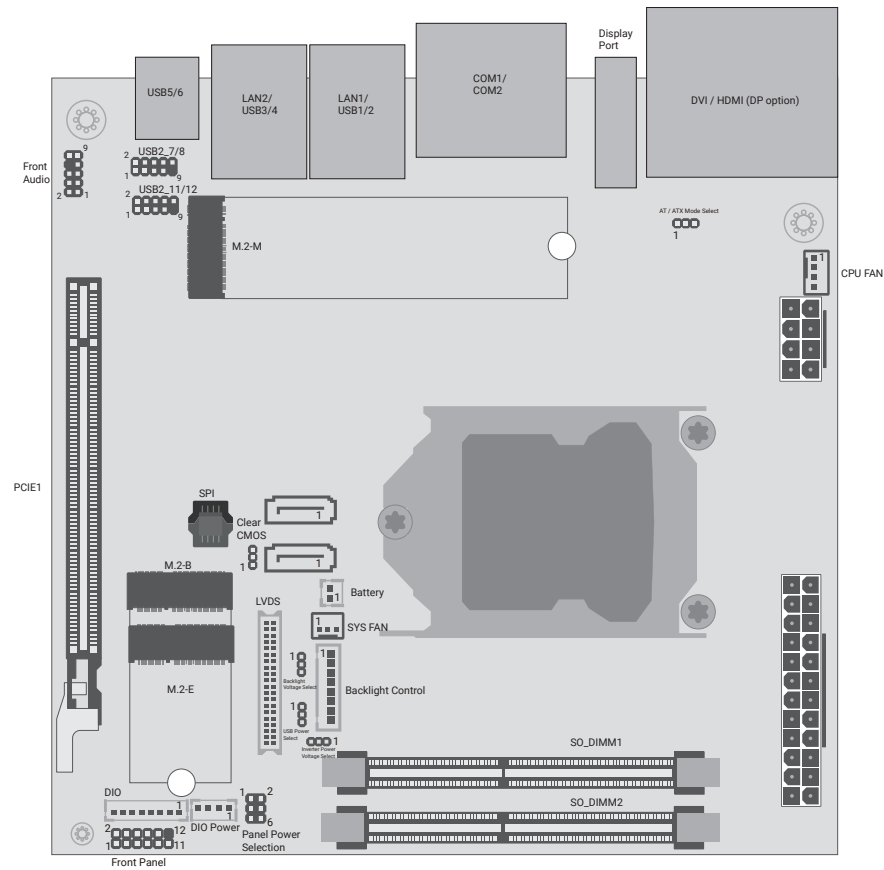

#### Bottom View

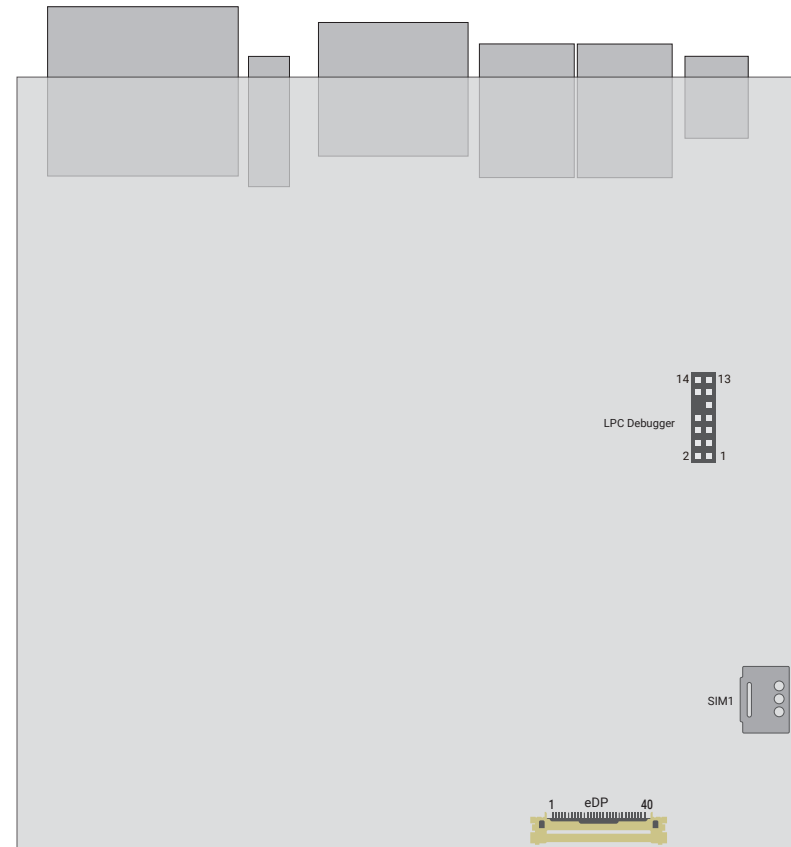

► Jumper Settings

Panel Power Selection (DPJP603)

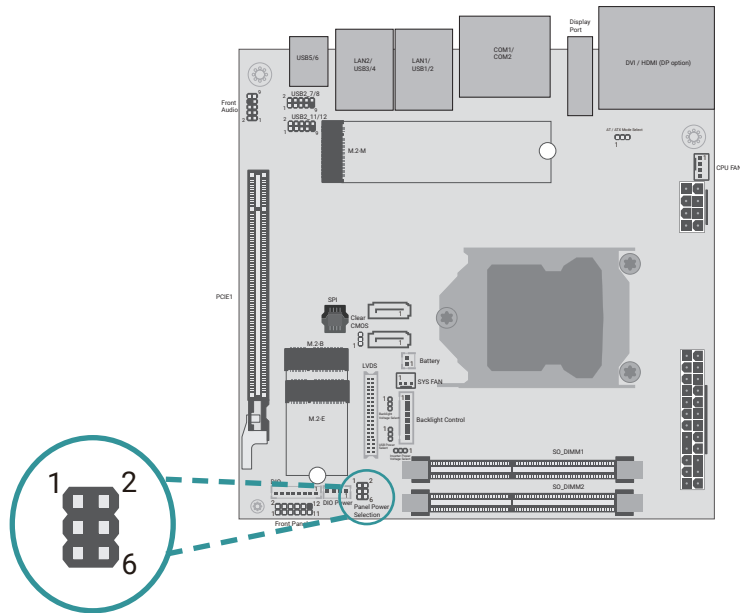

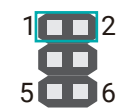
- 

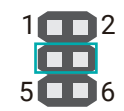
■ 1-2 On: 12V
- 

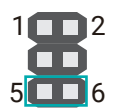
■ 3-4 On: 5V
- 

■ 5-6 On: 3.3V (Default)

Clear CMOS (JP1)

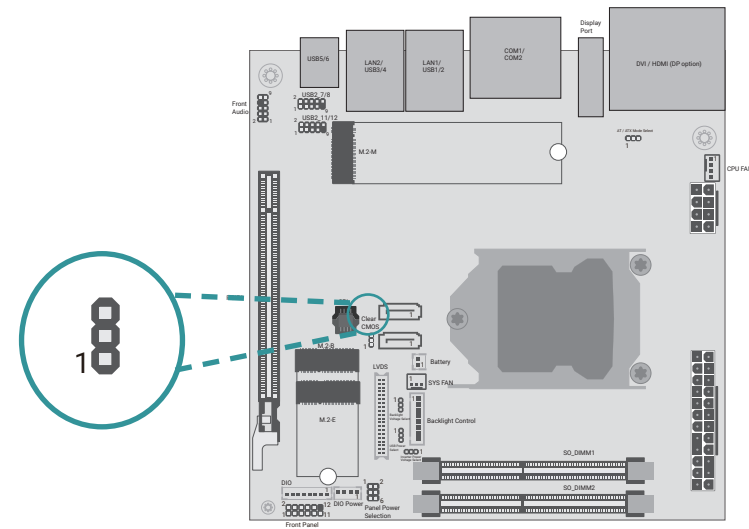

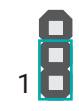
- 

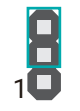
■ 1-2 On: Normal (Default)
- 

■ 2-3 On: Clear CMOS

Backlight Voltage Select (DPJP601)

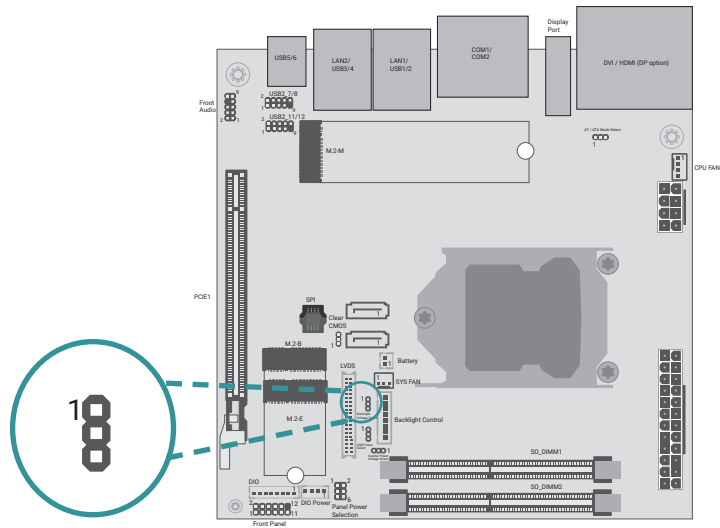

■ 1-2 On: 3V3 (Default)



■ 2-3 On: 5V

Inverter Power Voltage Select (DPJP602)

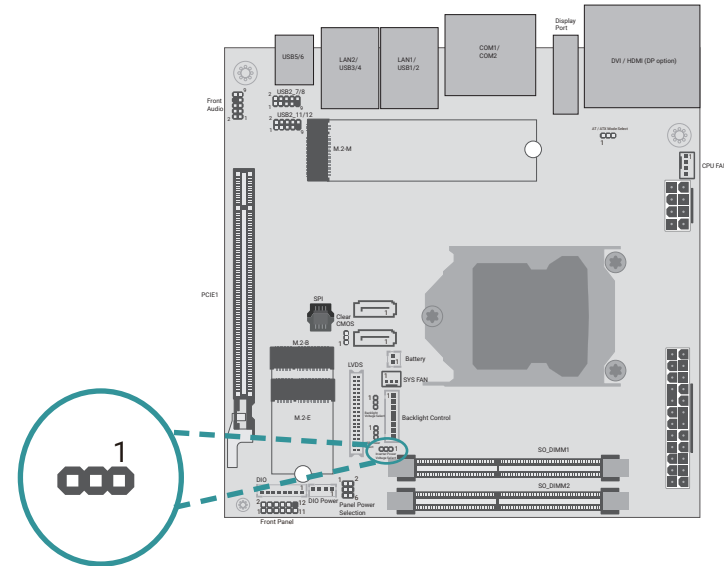

■ 1-2 On: +12V (Default)



■ 2-3 On: 5V

AT / ATX mode select (JP26)

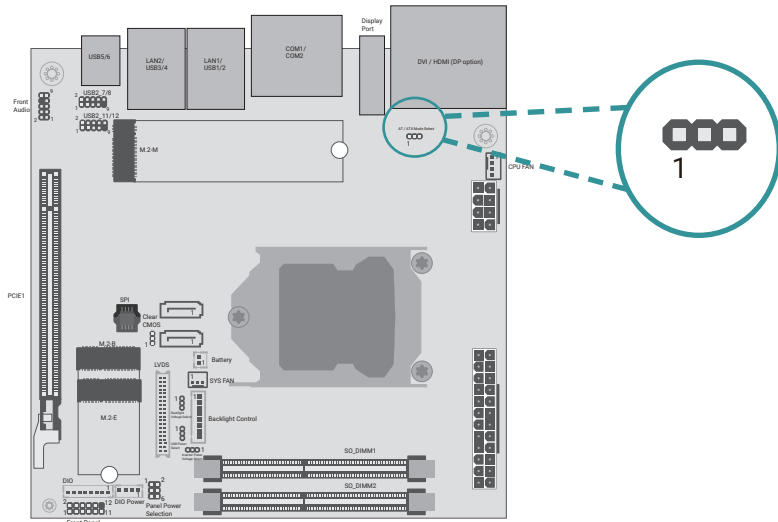

■ 1-2 On: AT (Default)



■ 2-3 On: ATX

USB Power Select (DPJP604)

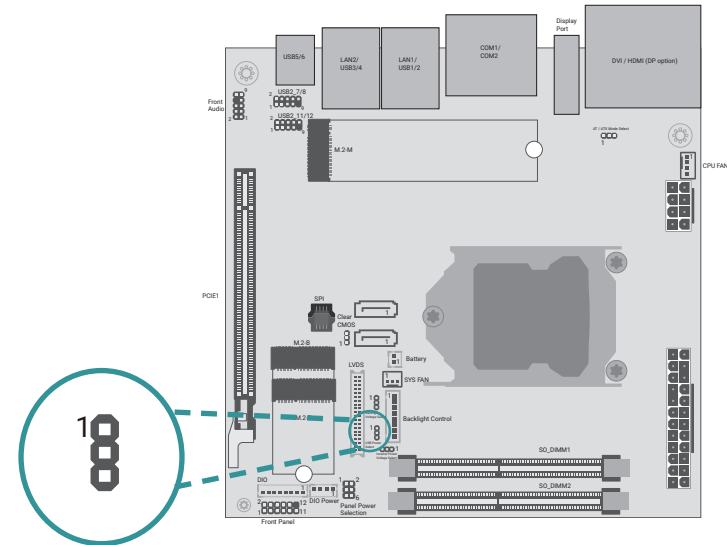

■ 1-2 On: 5V (Default)



■ 2-3 On: 5V

► Pin Assignment

Front Audio (AUJ2)

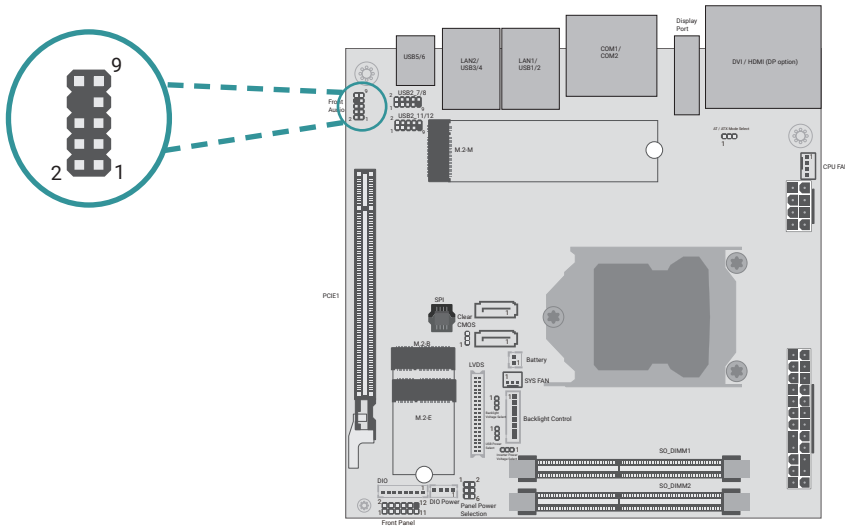

Pin	Assignment	Pin	Assignment
1	MIC2-L	2	GND
3	MIC2-R	4	--
5	LINE2-R	6	MIC2-JD
7	GND	8	--
9	LINE2-L	10	LINE2-JD

USB2\_11/12 (UBJ7)

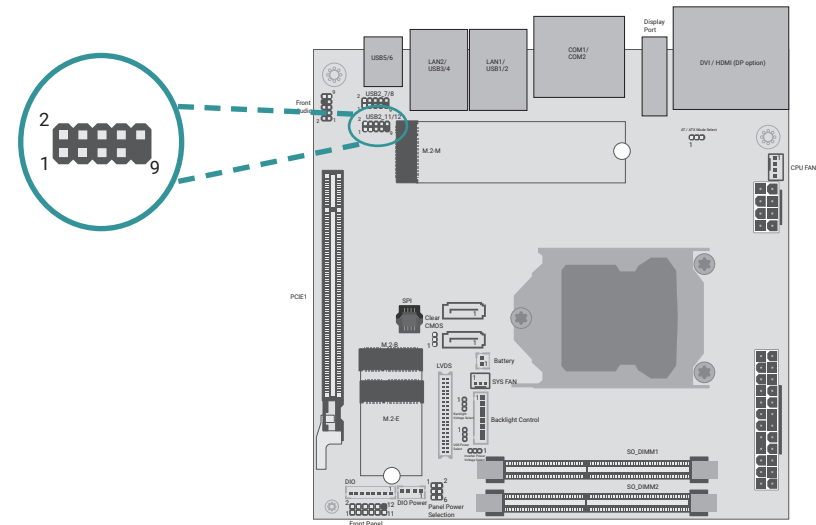

Pin	Assignment	Pin	Assignment
1	SBV4	2	SBV4
3	USBP_C_11N	4	USBP_C_12N
5	USBP_C_11P	6	USBP_C_12P
7	GND	8	GND
9	--	10	--

USB2\_7/8 (UBJ8)

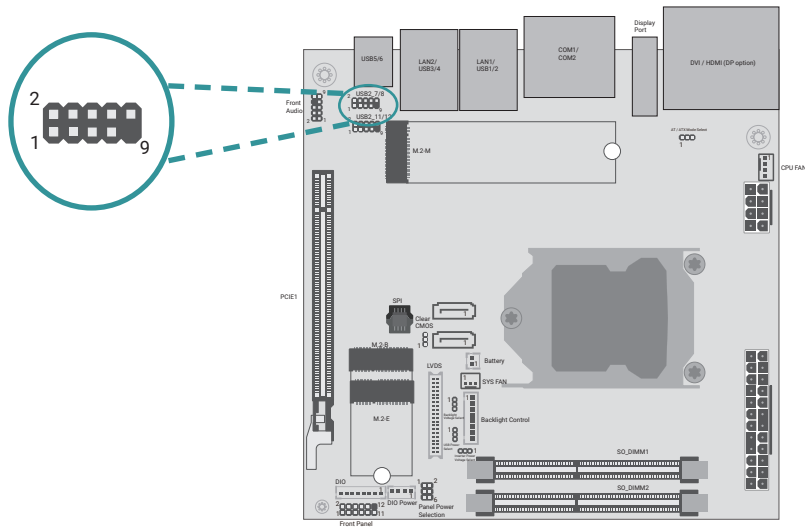

Pin	Assignment	Pin	Assignment
1	SBV4	2	SBV4
3	USBP_C_7N	4	USBP_C_8N
5	USBP_C_7P	6	USBP_C_8P
7	GND	8	GND
9	--	10	--

CPU Fan (J10)

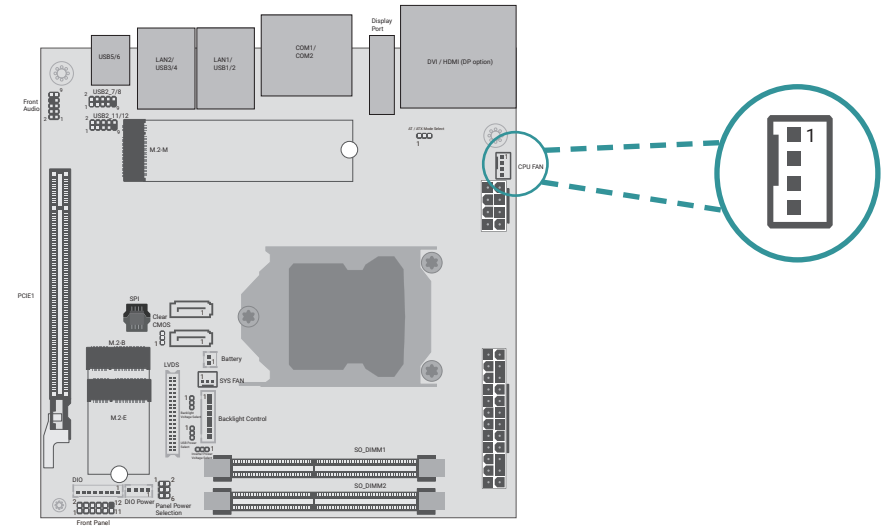

Pin	Assignment
1	GND
2	+12V
3	CPUFANIN
4	CPUFANOUT

System Fan (J9)

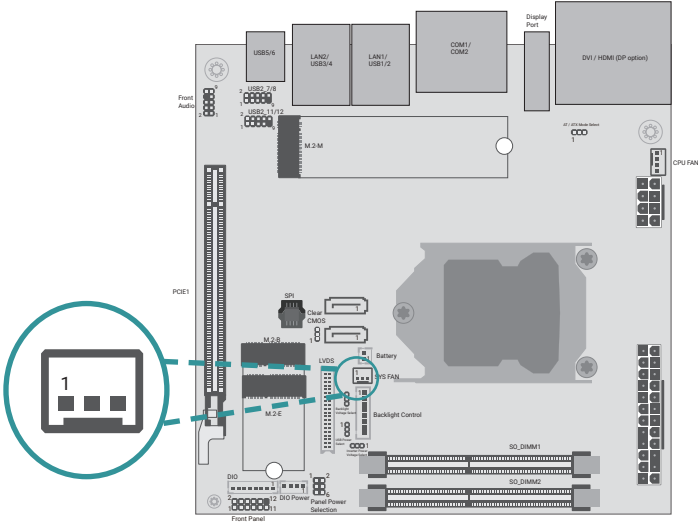

Pin	Assignment
1	GND
2	SYSFANOUT1
3	SYSFANIN1

Battery (J5)

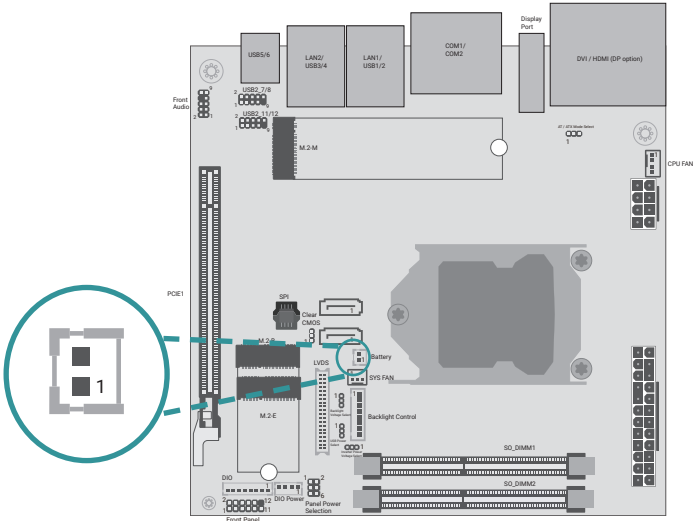

Pin	Assignment	Pin	Assignment
1	+3.3V	2	GND



Backlight Control (DPJ601)

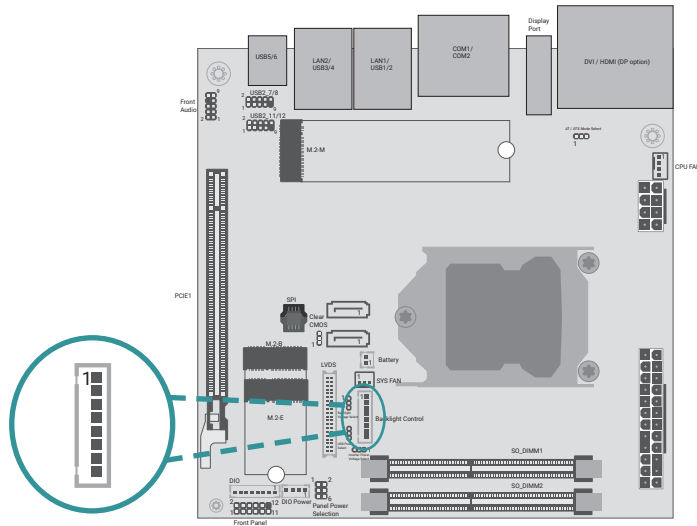

Pin	Assignment	Pin	Assignment
1	GND	2	GND
3	DIMMING	4	PANEL_PWR
5	LVDS_3V3	6	BLONOFF
7	VCC_INV_PWR	8	VCC_INV_PWR

DIO Power (J12)

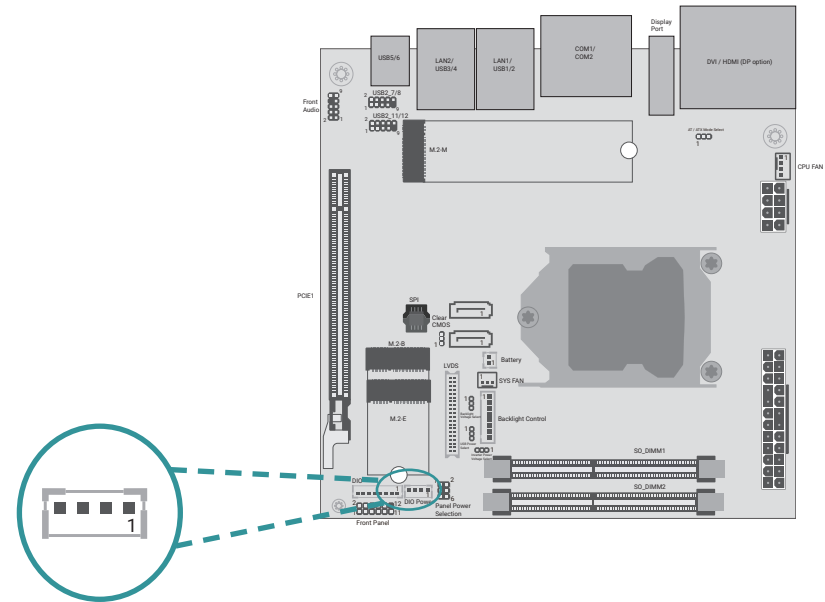

Pin	Assignment	Pin	Assignment
1	+12V	2	GND
3	5VDU	4	5V

DIO (J13)

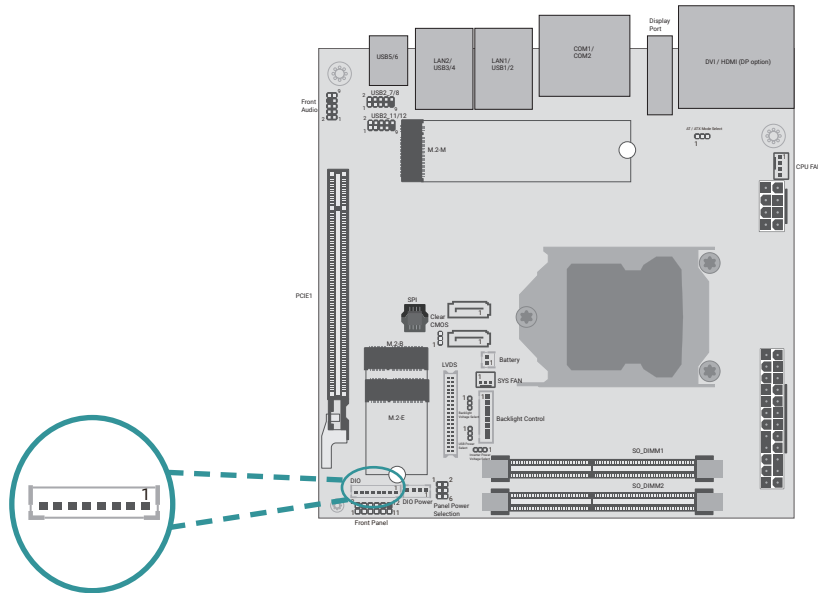

Pin	Assignment	Pin	Assignment
1	D_IOA0_C	2	D_IOA1_C
3	D_IOA2_C	4	D_IOA3_C
5	D_IOA4_C	6	D_IOA5_C
7	D_IOA6_C	8	D_IOA7_C

Front Panel (J11)

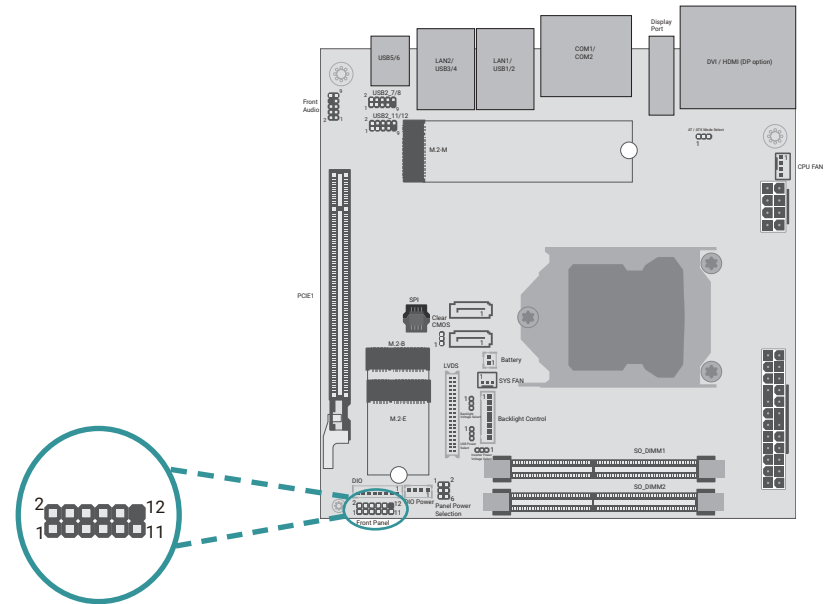

Pin	Function	Assignment	Function	Pin	Assignment
1		--		2	LED POWER
3	HDD LED	3V3	SYS LED	4	LED POWER
5		HD_LED		6	SUSLED
7	RESET	GND	POWER	8	GND
9		SYS_RST-		10	PWR_BTN-

LPC Debugger (J14)

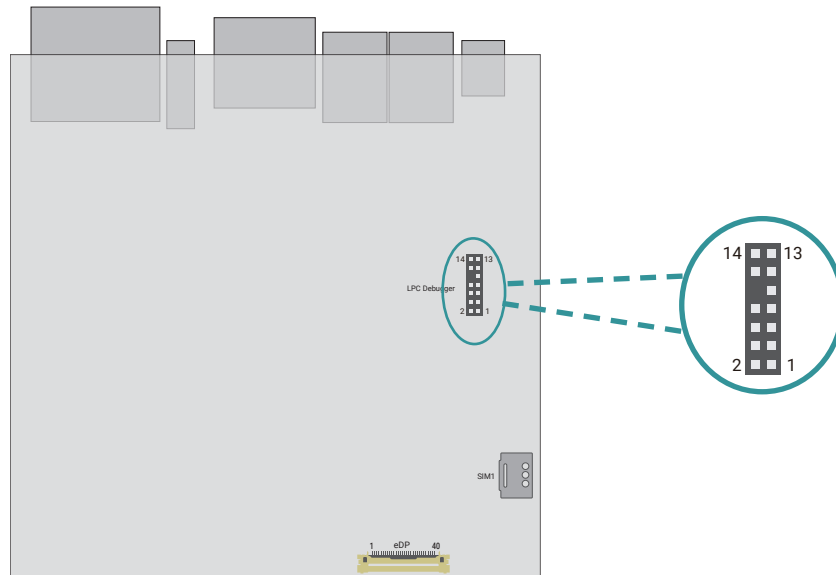

Pin	Assignment	Pin	Assignment
1	CLK	2	LAD1
3	RST#	4	LAD0
5	FRAME#	6	VCC3
7	LAD3	8	GND
9	LAD2	10	--
11	SERIRQ	12	GND
13	5VSB	14	5V

eDP (CN23)

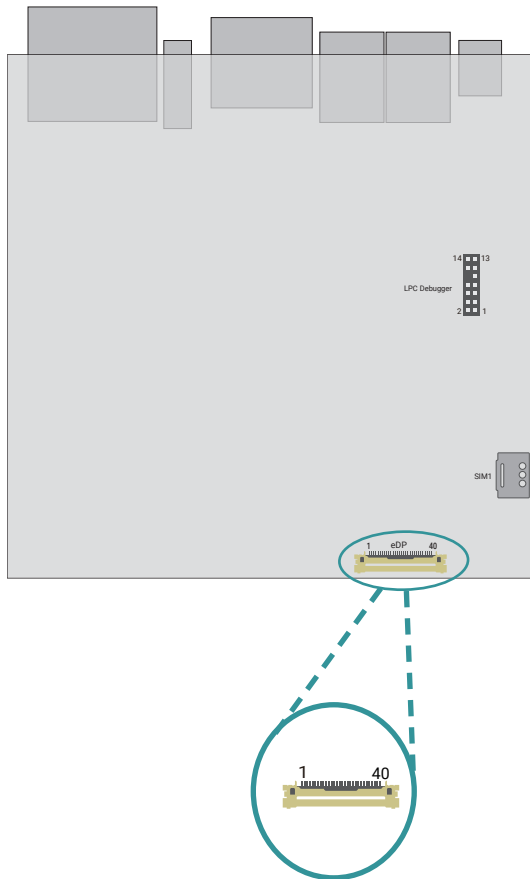

Pin	Assignment	Pin	Assignment
1	--	2	VCC_INV_PWR
3	VCC_INV_PWR	4	VCC_INV_PWR
5	VCC_INV_PWR	6	--
7	--	8	DIMMING
9	BLONOFF	10	eDP_GND
11	eDP_GND	12	eDP_GND
13	eDP_GND	14	eDP_HP_D_B_R
15	GND	16	GND
17	GND	18	GND
19	--	20	PANEL_PWR
21	PANEL_PWR	22	PANEL_PWR
23	PANEL_PWR	24	GND
25	eDP_AUXN_C	26	eDP_AUXP_C
27	GND	28	eDP_LANE0_P
29	eDP_LANE0_N	30	GND
31	eDP_LANE1_P	32	eDP_LANE1_N
33	GND	34	eDP_LANE2_P
35	eDP_LANE2_N	36	GND
37	eDP_LANE3_P	38	eDP_LANE3_N
39	GND	40	--

## ► Expansion Slots

### Installing the M.2 Module

Before installing the M.2 module into the M.2 socket, please make sure that the following safety cautions are well-attended.

1. Make sure the PC and all other peripheral devices connected to it has been powered down.
2. Disconnect all power cords and cables.
3. Locate the M.2 socket on the system board
4. Make sure the notch on card is aligned to the key on the socket.
5. Make sure the standoff screw is removed from the standoff.

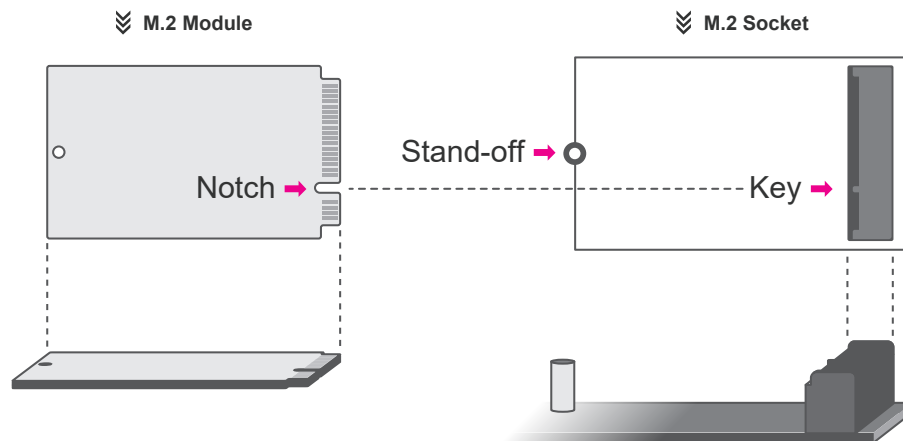

Please follow the steps below to install the card into the socket.

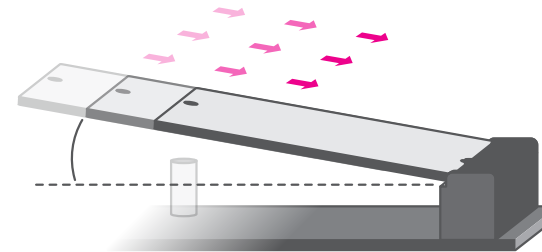

**Step 1:**  
Insert the card into the socket at an angle while making sure the notch and key are perfectly aligned.

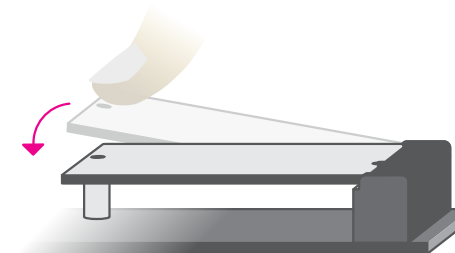

**Step 2:**  
Press the end of the card far from the socket down until against the stand-off.

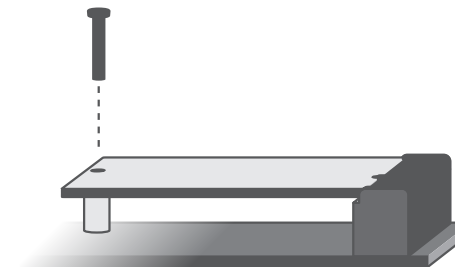

**Step 3:**  
Screw tight the card onto the stand-off with a screw driver and a stand-off screw until the gap between the card and the stand-off closes up. The card should be lying parallel to the board when it's correctly mounted.

### Installing the SO-DIMM Module

Before installing the memory module, please make sure that the following safety cautions are well-attended.

1. Make sure the PC and all other peripheral devices connected to it has been powered down.
2. Disconnect all power cords and cables.
3. Locate the SO-DIMM socket on the system board
4. Make sure the notch on memory card is aligned to the key on the socket.

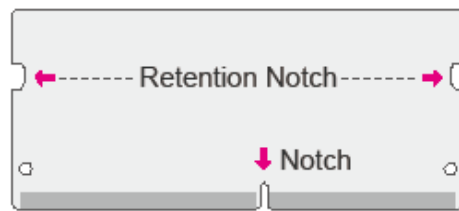

◀◀ DDR4 SO-DIMM

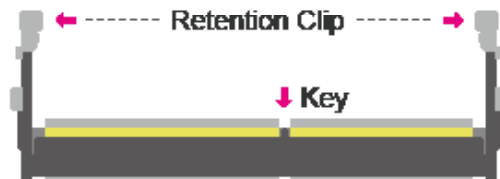

◀◀ Socket Top View

Please follow the steps below to install the memory card into the socket.

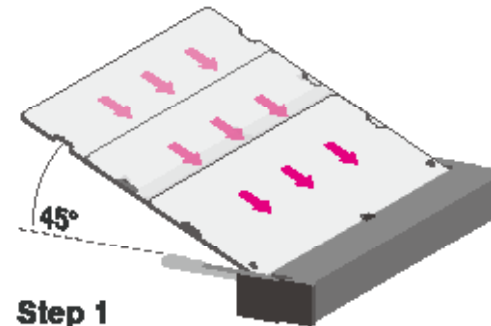

Step 1

the memory card into the slot making sure 1) the notch and the key are aligned, and 2) the non-connecting pins are aligned. Press the card firmly into the socket while applying an even pressure on both ends.

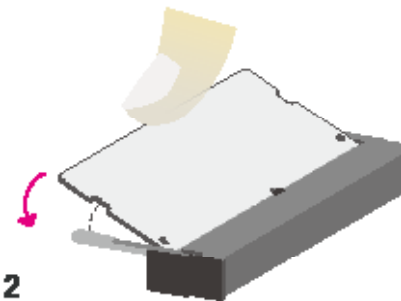

Step 2

the end of the card far from the socket down while making sure the retention notch and the clip align correctly. If the retention notch and key do not align, please remove the card and re-insert it. Press the card all the way down.

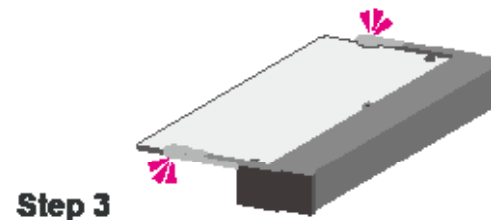

Step 3

The retention clips snap automatically and lock the card in place, producing a distinctive click, and the card is seated in place. Inspect that the card is seated in the notch. If not, please pull the card outwards, release and remove it, and mount it again.

## Chapter 3 - BIOS Settings

### ► Overview

The BIOS is a program that takes care of the basic level of communication between the CPU and peripherals. It contains codes for various advanced features found in this system board. The BIOS allows you to configure the system and save the configuration in a battery-backed CMOS so that the data retains even when the power is off. In general, the information stored in the CMOS RAM of the EEPROM will stay unchanged unless a configuration change has been made such as a hard drive replaced or a device added. It is possible that the CMOS battery will fail causing CMOS data loss. If this happens, you need to install a new CMOS battery and reconfigure the BIOS settings.



#### Note:

The BIOS is constantly updated to improve the performance of the system board; therefore the BIOS screens in this chapter may not appear the same as the actual one. These screens are for reference purpose only.

#### Default Configuration

Most of the configuration settings are either predefined according to the Load Optimal Defaults settings which are stored in the BIOS or are automatically detected and configured without requiring any actions. There are a few settings that you may need to change depending on your system configuration.

#### Entering the BIOS Setup Utility

The BIOS Setup Utility can only be operated from the keyboard and all commands are keyboard commands. The commands are available at the right side of each setup screen. The BIOS Setup Utility does not require an operating system to run. After you power up the system, the BIOS message appears on the screen and the memory count begins. After the memory test, the message "Press DEL to run setup" will appear on the screen. If the message disappears before you respond, restart the system or press the "Reset" button. You may also restart the system by pressing the <Ctrl> <Alt> and <Del> keys simultaneously.

### Legends

Keys	Function
Right / Left arrow	Move the highlight left or right to select a menu
Up / Down arrow	Move the highlight up or down between submenus or fields
<Enter>	Enter the highlighted submenu
+ (plus key)/F6	Scroll forward through the values or options of the highlighted field
- (minus key)/F5	Scroll backward through the values or options of the highlighted field
<F1>	Display general help
<F2>	Display previous values
<F7>	Popup Boot Device List
<F9>	Optimized defaults
<F10>	Save and Exit
<Esc>	Return to previous menu

#### Scroll Bar

When a scroll bar appears to the right of the setup screen, it indicates that there are more available fields not shown on the screen. Use the up and down arrow keys to scroll through all the available fields.

#### Submenu

When "►" appears on the left of a particular field, it indicates that a submenu which contains additional options are available for that field. To display the submenu, move the highlight to that field and press <Enter>.

► Main

The Main menu is the first screen that you will see when you enter the BIOS Setup Utility.

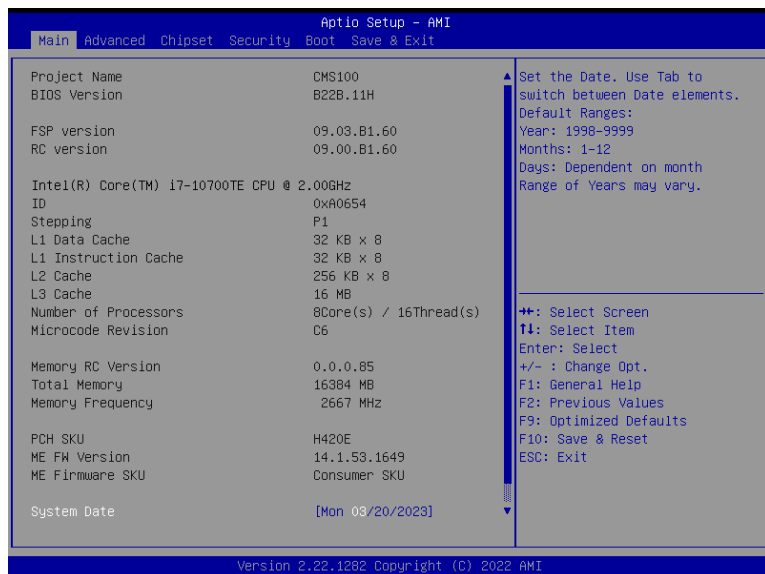

**System Date**

The date format is <month>, <date>, <year>. Press "Tab" to switch to the next field and press "-" or "+" to modify the value.

**System Time**

The time format is <hour>, <minute>, <second>. The time is based on the 24-hour military-time clock. For example, 1 p.m. is 13:00:00. Hour displays hours from 00 to 23. Minute displays minutes from 00 to 59. Second displays seconds from 00 to 59.

► Advanced

The Advanced menu allows you to configure your system for basic operation. Some entries are defaults required by the system board, while others, if enabled, will improve the performance of your system or let you set some features according to your preference.

 **Important:**  
Setting incorrect field values may cause the system to malfunction.

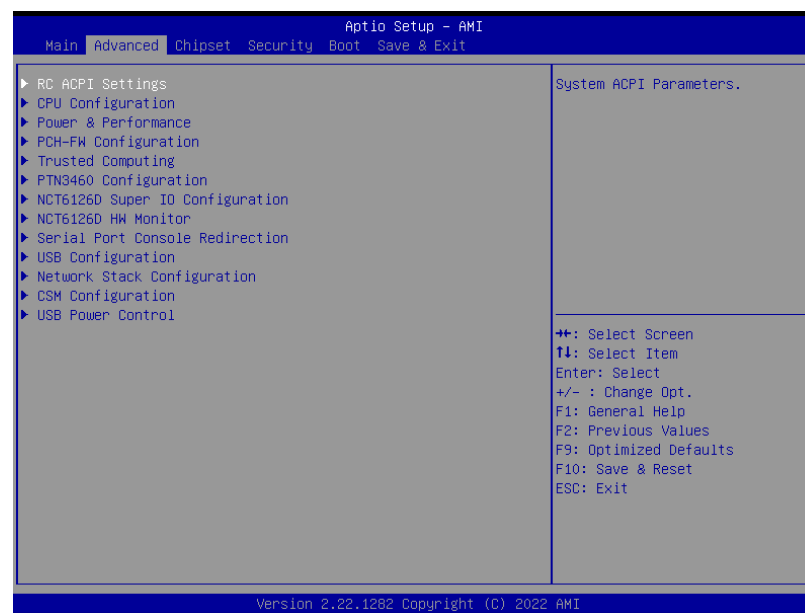



► Advanced

RC ACPI Settings



**Wake system from S5 via RTC**

When Enabled, the system will automatically power up at a designated time every day. Once it's switched to [Enabled], please set up the time of day – hour, minute, and second – for the system to wake up.

**State After G3**

Select between S0 State, and S5 State. This field is used to specify what state the system is set to return to when power is re-applied after a power failure (G3 state).

- **S0 State** The system automatically powers on after power failure.
- **S5 State** The system enter soft-off state after power failure. Power-on signal input is required to power up the system.
- **Last State** The system returns to the last state right before power failure.

► Advanced

CPU Configuration



**Intel (VMX) Virtualization Technology**

When this field is set to Enabled, the VMM can utilize the additional hardware capabilities provided by Vanderpool Technology.

**Active Processor Cores**

Select number of cores to enable in each processor package: all or 1.

**Hyper-threading**

Enables this field for Windows XP and Linux which are optimized for Hyper-Threading technology. Select disabled for other OSes not optimized for Hyper-Threading technology. When disabled, only one thread per enabled core is enabled.

▶ Advanced

Power & Performance

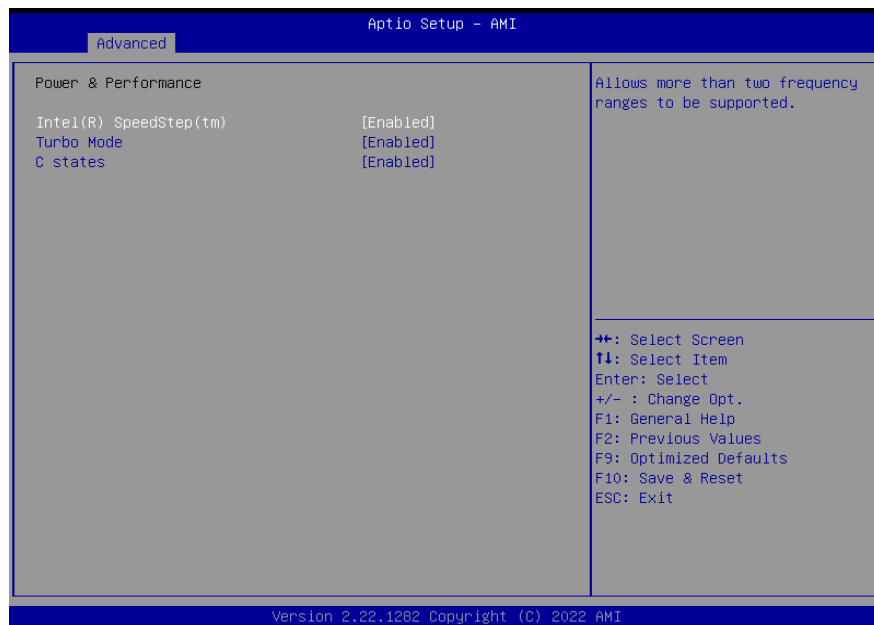

**Intel (R) SpeedStep(tm)**

This field is used to enable or disable the Intel SpeedStep® Technology, which helps optimize the balance between system's power consumption and performance. After it is enabled in the BIOS, EIST features can then be enabled via the operating system's power management.

**Turbo Mode**

Enable or disable turbo mode of the processor. This field will only be displayed when EIST is enabled.

**C states**

Enable or disable CPU Power Management. It allows CPU to enter "C states" when it's idle and nothing is executing.

▶ Advanced

PCH-FW Configuration

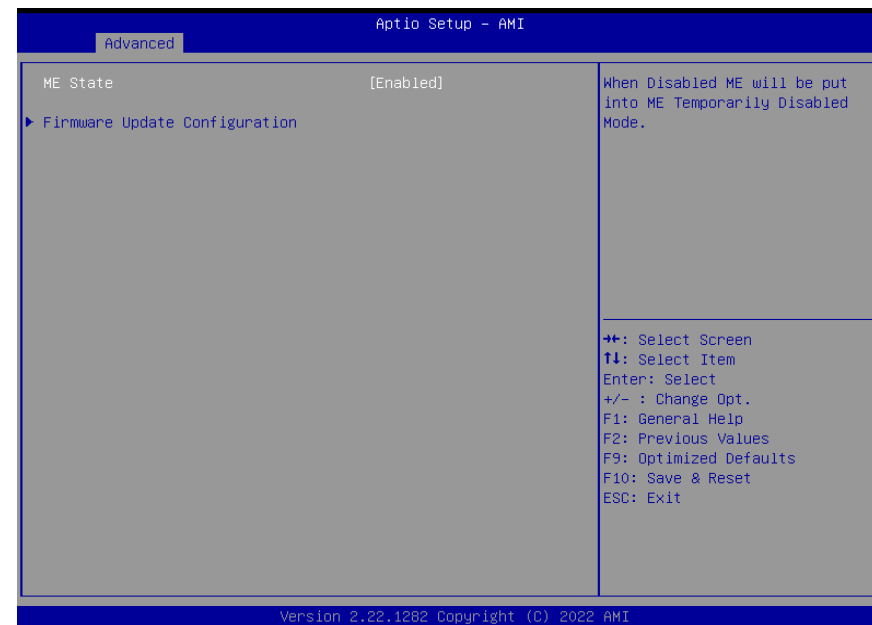

**ME State**

When this field is set to Disabled, ME will be put into ME Temporarily Disabled Mode.

**Firmware Update Configuration**

Configure Management Engine Technology Parameters.



**Note:**  
The sub-menus are detailed in following sections.

▶ Advanced

Trusted Computing



**Security Device Support**

This field is used to enable or disable BIOS support for the security device such as an TPM 2.0 to achieve hardware-level security via cryptographic keys.

**Pending operation**

To clear the existing TPM encryption, select "TPM Clear" and restart the system. This field is not available when "Security Device Support" is disabled.

▶ Advanced

PTN3460 Configuration

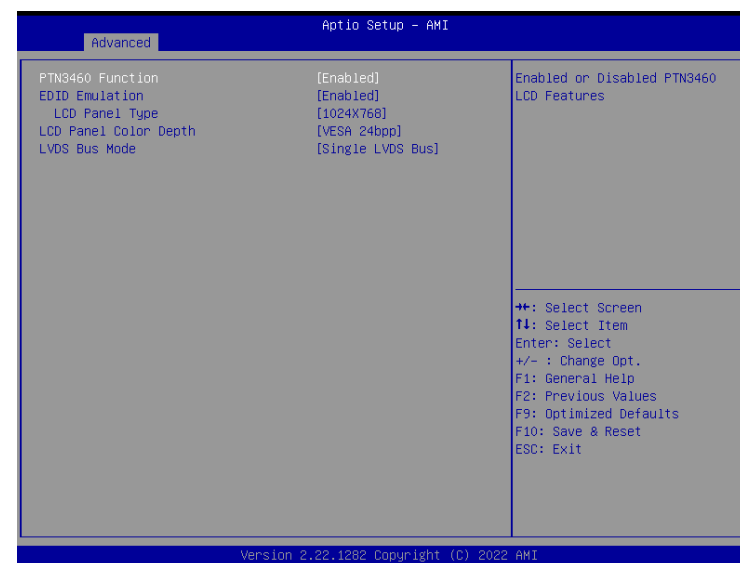

**PTN3460 Function**

Enable or Disable PTN3460 LCD Features. When this field is disabled, the following fields will remain hidden.

**LCD Panel Type**

Select the resolution of the LCD Panel – 800X480, 800X600, 1024X768, 1366X768, 1280X1024, 1920X1080, or 1920X1200.

**LCD Panel Color Depth**

Select the color depth of the LCD Panel – VESA 24bpp, JEIDA 24bpp, VESA and JEIDA 18 bpp.

**LVDS Bus Mode**

Select PTN3460 LVDS BUS Mode : Single LVDS Bus /Dual LVDS Bus



**Note:**

The configuration must match the specifications of your LCD Panel in order for the LCD Panel to display properly.

► Advanced

NCT6126D Super IO Configuration



**WatchDog Output Options**

Select the Output Options.

- **Mode1 (System Reset) =**  
A Watchdog Timeout causes the system to be reset.
- **Mode2 (Output Only) =**  
WDT pin goes high upon timeout of the watchdog timer.
- **Mode3 (Generate NMI) =**  
Generate NMI upon timeout of the watchdog timer.

**WatchDog Timer Unit**

Select WatchDog Timer Unit – Second or Minute.

**SuperIO WatchDog Timer**

Set SuperIO WatchDog Timer Timeout value. The range is from 0 (disabled) to 255.



**Note:**  
The sub-menus are detailed in following sections.

► Advanced

NCT6126D HW Monitor

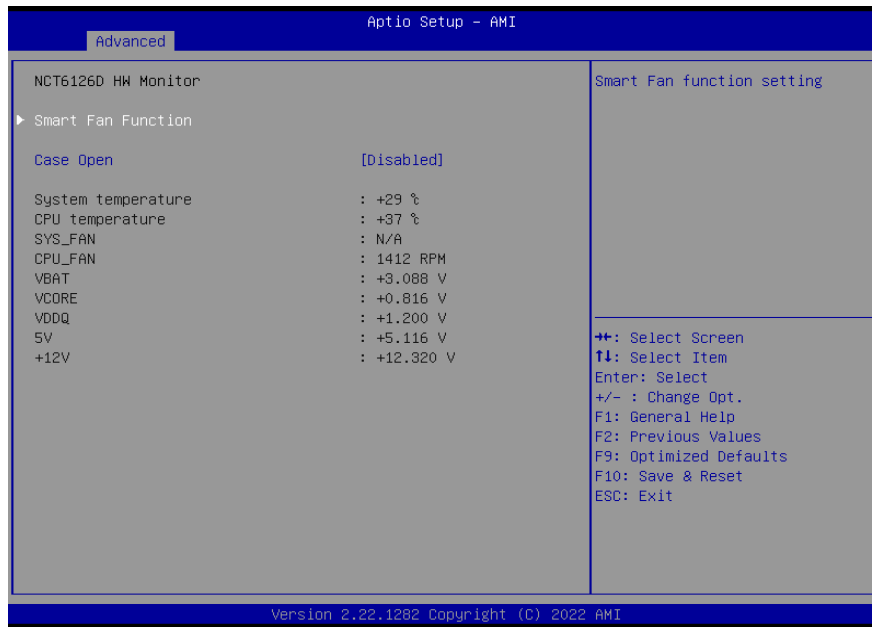

This section displays the system's health information, i.e. voltage readings, CPU and system temperatures, and fan speed readings

**Case Open**

Enable or disable the case open detection function.

► Advanced

NCT6126D HW Monitor ► Smart FAN Function

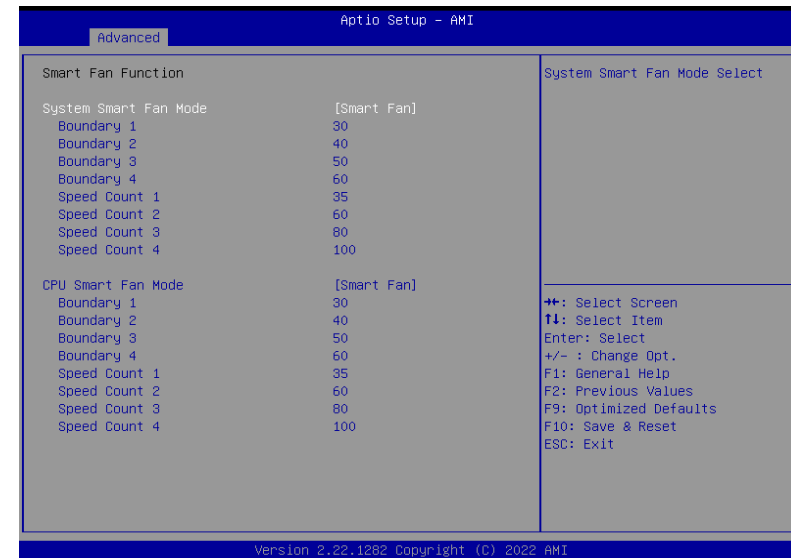

Smart Fan is a fan speed moderation strategy dependent on the current system temperature. When the system temperature goes higher than the Boundary setting, the fan speed will be turned up to the setting of the Fan Speed Count that bears the same index as the Boundary field.

**SYS Smart Fan/CPU Smart Fan Control = [Enabled]**

• **Boundary 1 to Boundary 4**

Set the boundary temperatures that determine the fan speeds accordingly, the value ranging from 0-127°C. For example, when the system temperature reaches Boundary 1 setting, the fan speed will be turned up to the designated speed of the Fan Speed Count 1 field.

• **Fan Speed Count 1 to Fan Speed Count 4**

Set the fan speed, the value ranging from 1-100%, 100% being full speed. The fans will operate according to the specified boundary temperatures above-mentioned.

▶ **Advanced**

**Serial Port Console Redirection**

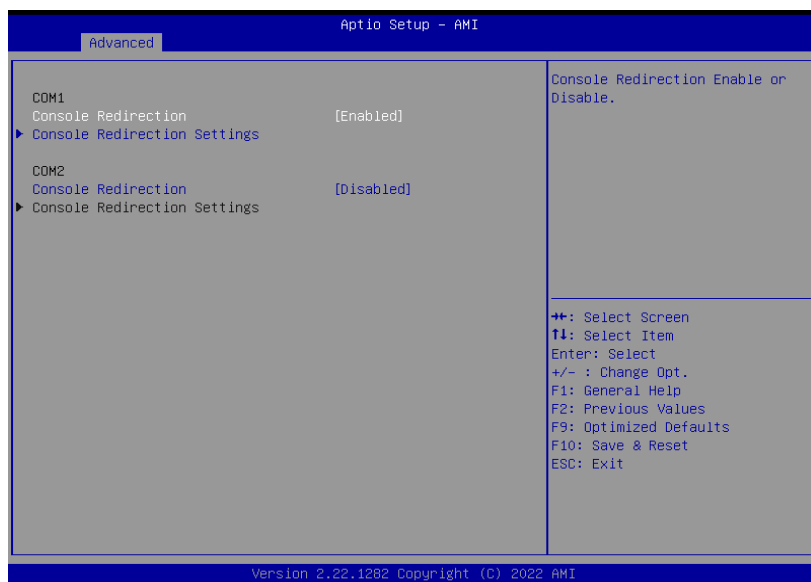

▶ **Advanced**

**Serial Port Console Redirection ▶ Console Redirection Settings**

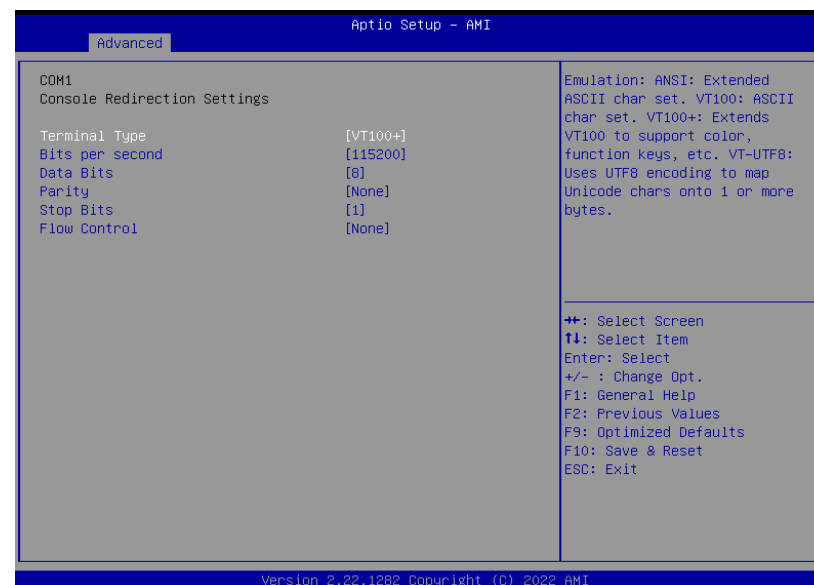

**Console Redirection**

By enabling Console Redirection of a COM port, the sub-menu of console redirection settings will become available for configuration as detailed in the following.

Configure the serial settings of the current COM port.

**Terminal Type**

Select terminal type: VT100, VT100+, VT-UTF8 or ANSI.

**Bits per second**

Select serial port transmission speed: 9600, 19200, 38400, 57600 or 115200.

**Data Bits**

Select data bits: 7 bits or 8 bits.

**Parity**

Select parity bits: None, Even, Odd, Mark or Space.

**Stop Bits**

Select stop bits: 1 bit or 2 bits.

**Flow Control**

Select flow control type: None or Hardware RTS/CTS. Flow Control is for RS485 mode and is only supported by Serial Port 1 (COM1).

► Advanced

## USB Configuration

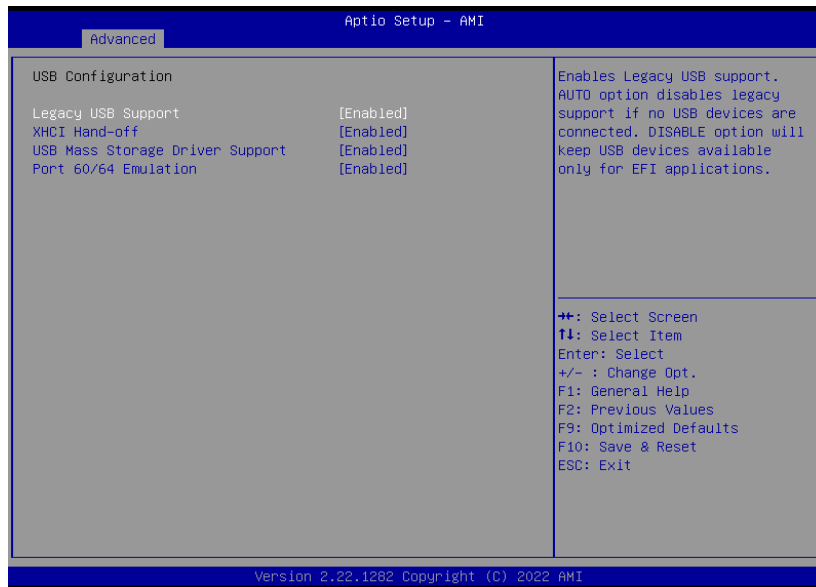

### Legacy USB Support

- **Enabled** Enable Legacy USB support.
- **Disabled** Keep USB devices available only for EFI applications.
- **Auto** Disable Legacy support if no USB devices are connected.

### XHCI Hand-off

Enable or disable XHCI Hand-off.

### USB Mass Storage Driver Support

Enable or disable USB Mass Storage Driver Support.

### Port 60/64 Emulation

Enables I/O port 60h/64h emulation support. This should be enabled for the complete USB keyboard legacy support for non-USB aware Oses.

► Advanced

## Network Stack Configuration



### Network Stack

Enable or disable UEFI network stack. The following fields will appear when this field is enabled.

### IPv4 PXE Support

Enable or disable IPv4 PXE boot support. If disabled, IPv4 PXE boot support will not be available.

### IPv6 PXE Support

Enable or disable IPv6 PXE boot support. If disabled, IPv6 PXE boot support will not be available.

### PXE boot wait time

Set the wait time in seconds to press ESC key to abort the PXE boot. Use either +/- or numeric keys to set the value.

### Media detect count

Set the number of times the presence of media will be checked. Use either +/- or numeric keys to set the value.

▶ Advanced

### CSM Configuration

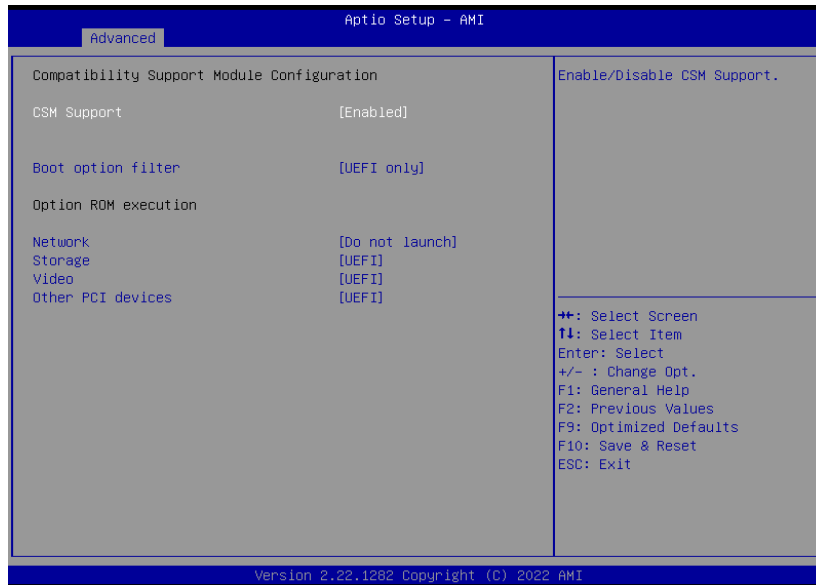

#### CSM Support

This section is used to enable or disable CSM Support. The following fields are only available when "CSM Support" is enabled.

#### Boot option filter

This field controls Legacy/UEFI ROMs priority. Select among UEFI and Legacy, Legacy only or UEFI only.

#### Network

This field controls the execution of UEFI and Legacy Network OpROM.

#### Storage

This field controls the execution of UEFI and Legacy Storage OpROM.

#### Video

This field controls the execution of UEFI and Legacy Video OpROM.

#### Other PCI devices

This field determines OpROM execution policy for devices other than Network, Storage or Video.

▶ Advanced

### USB Power Control



#### Server CA Configuration

**5\_Dual1:** Support system wake up from S3/S4 by USB KB&MS

**5V:** No support system wake up from S3/S4 by USB KB&MS



► Chipset



Please select a submenu and press Enter. The submenus are detailed in the following pages.

► Chipset

Graphics Configuration

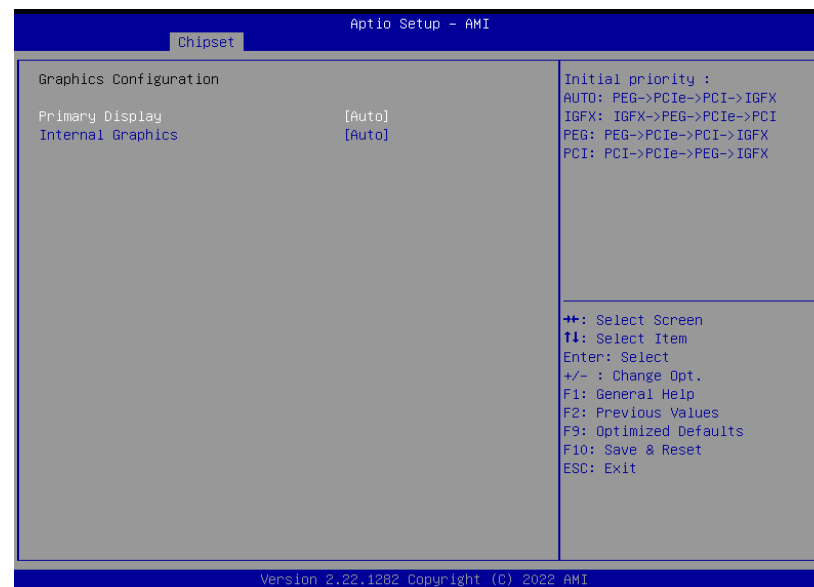

**Primary Display**

Select which of IGFX/PEG/PCI Graphics device to be the primary display.

**Internal Graphics**

Keep IGFX "Enabled" or "Disabled" based on the setup options, or select "Auto" for auto-detection.

► Chipset

PEG Port Configuration

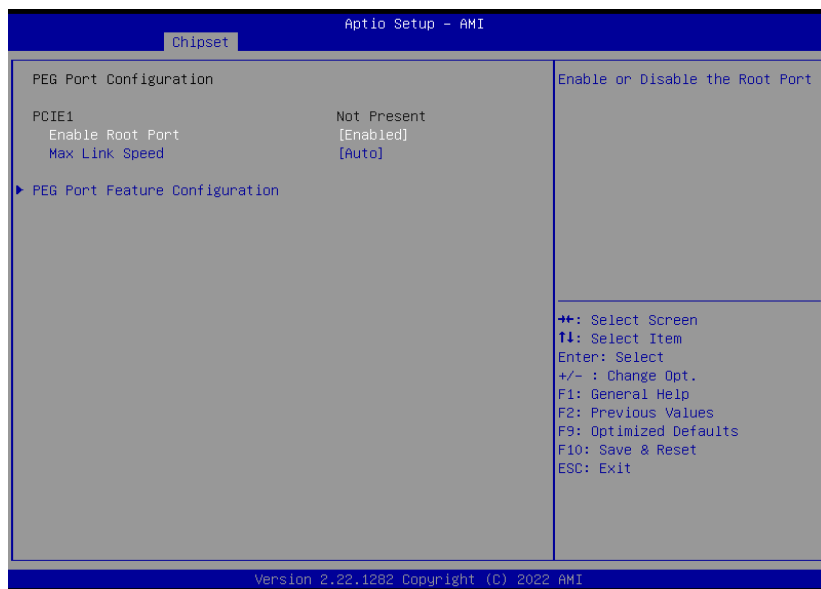

**Enable Root Port**

Enable or Disable the Root Port

**Max Link Speed**

Configure PEG 0:1:0 Max Speed

► Chipset

PCH-IO Configuration

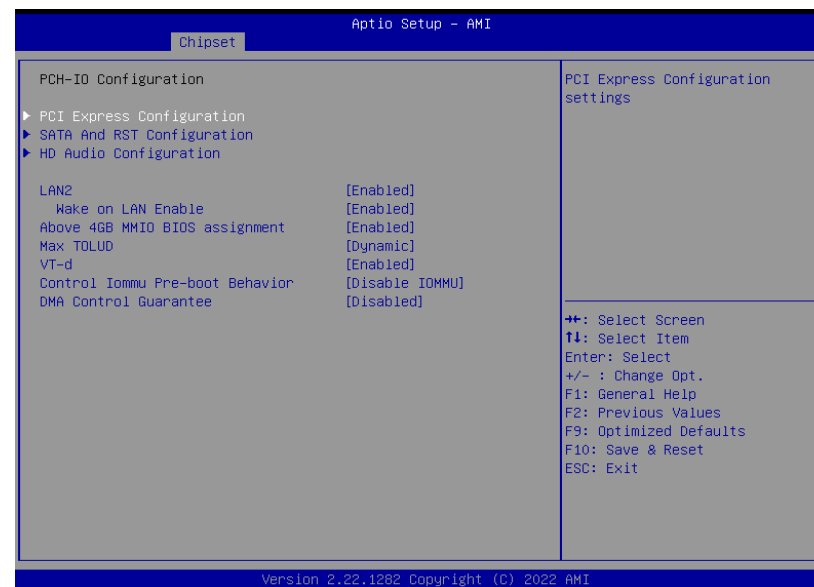

**PCI Express Configuration**

PCI Express Configuration Settings

**SATA And RST Configuration**

SATA Device Options Settings

**HD Audio Configuration**

HD Audio Subsystem Configuration Settings

**LAN2**

Enable/Disable onboard NIC.

**Wake on LAN Enable**

Enable/Disable integrated LAN to wake the system.

**Above 4GB MMIO BIOS assignment**

Enable/Disable above 4GB MemoryHappedIO BIOS assignment.

This is enabled automatically when Aperture Size is set to 2048MB.

### Max TOLUD

Maximum Value of TOLUD.

Dynamic assignment would adjust TOLD automatically based on largest MMIO length of installed graphic controller.

### VT-d

VT-d capability

### Control Iommu Pre-boot Behavior

Enable dTBT and PCH USB topology IOMMU in Pre-boot environment (If DMAR table is installed in DXE and If VTD\_INFO\_PPI is installed in PEI. ) TBT tree won't be included in the exception list.

### DMA Control Guarantee

Enable/Disable DMA\_CONTROL\_GUARANTEE bit.

### ▶ Chipset

#### PCH-IO Configuration ▶ PCI Express Configuration



Select one of the PCI Express channels and press enter to configure the following settings.

### LAN 1, M.2-B, M.2-E, M.2-M

Control the PCI Express Root Port.

### PCIe Speed

Select PCIe Speed of the current port – AUTO, Gen1, Gen 2, or Gen3. This field may not appear when the speed of the port is not configurable.

► Chipset

PCH-IO Configuration ► SATA And RST Configuration

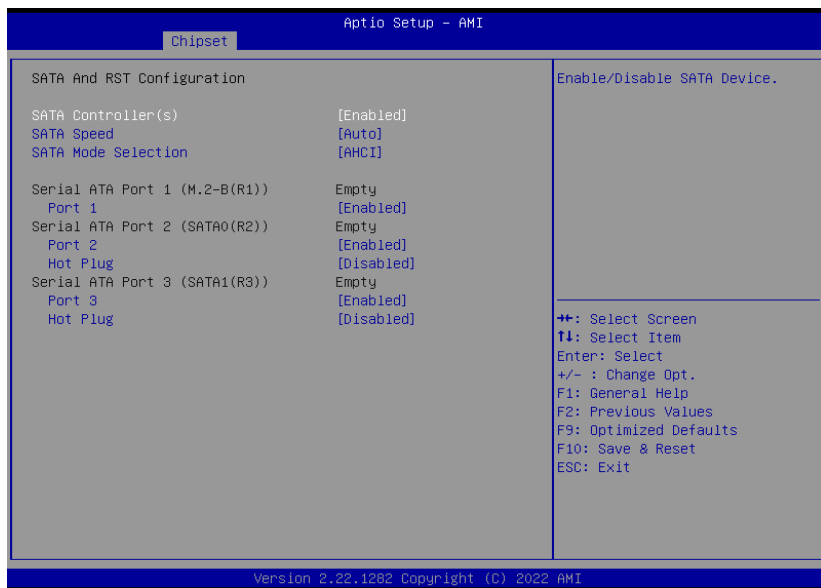

**SATA Controller(s)**

This field is used to enable or disable the Serial ATA controller.

**SATA Speed**

This field is used to select SATA speed generation limit: Auto, Gen1, Gen2 or Gen3.

**SATA Mode Selection**

The mode selection determines how the SATA controller(s) operates.

- **AHCI** This option allows the Serial ATA controller(s) to use AHCI (Advanced Host Controller Interface).
- **Intel RST Premium With Intel Optane System Acceleration** This option allows you to create RAID or Intel Rapid Storage configuration along with Intel® Optane™ system acceleration on Serial ATA devices.

► Chipset

PCH-IO Configuration ► HD Audio Configuration



**HD Audio**

Control the detection of the HD Audio device.

- **Disabled** HDA will be unconditionally disabled.
- **Enabled** HDA will be unconditionally enabled.

► Security

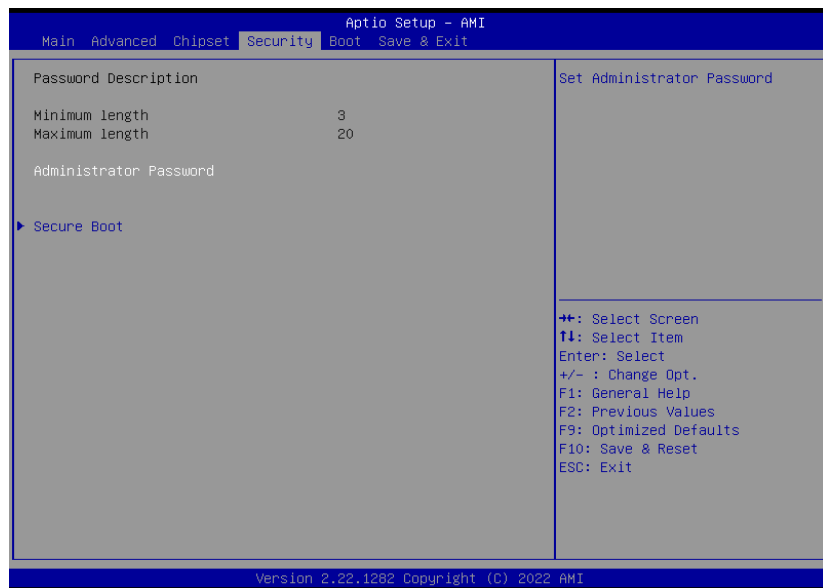

**Administrator Password**

Set the administrator password. To clear the password, input nothing and press enter when a new password is asked. Administrator Password will be required when entering the BIOS.

► Security

Secure Boot



**Secure Boot**

The Secure Boot store a database of certificates in the firmware and only allows the OSEs with authorized signatures to boot on the system. To activate Secure Boot, please make sure that "Secure Boot" is "[Enabled]", Platform Key (PK) is enrolled, "System Mode" is "User", and CSM is disabled. After enabling/disabling Secure Boot, please save the configuration and restart the system. When configured and activated correctly, the Secure Boot status will be "Active".

**Secure Boot Mode**

Select the secure boot mode – Standard or Custom. When set to Custom, the following fields will be configurable for the user to manually modify the key database.

**Restore Factory Keys**

Force system to User Mode. Load OEM-defined factory defaults of keys and databases onto the Secure Boot. Press Enter and a prompt will show up for you to confirm.

**Reset To Setup Mode**

Clear the database from the NVRAM, including all the keys and signatures installed in the Key Management menu. Press Enter and a prompt will show up for you to confirm.

► **Boot**



**Setup Prompt Timeout**

Set the number of seconds to wait for the setup activation key. 65535 (0xFFFF) denotes indefinite waiting.

**Bootup NumLock State**

Select the keyboard NumLock state: On or Off.

**Quiet Boot**

This section is used to enable or disable quiet boot option.

**Boot Option Priorities**

Rearrange the system boot order of available boot devices.



**Note:**

If “Boot option filter” of “CSM Configuration” is set to “UEFI and Legacy” or “UEFI only”, and “Quiet Boot” is set to enabled, “BGRT Logo” will show up for configuration. Refer to the Advanced > CSM Configuration submenu for more information.

► **Save & Exit**

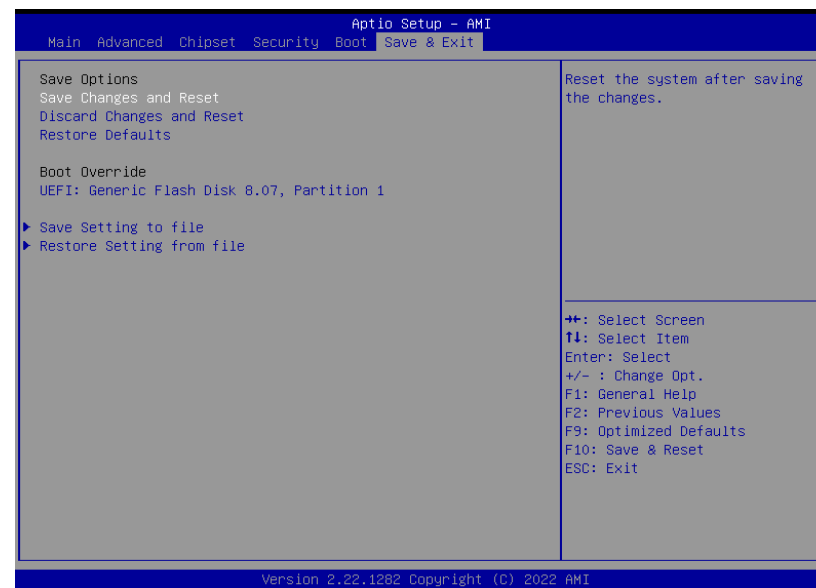

**Save Changes and Reset**

To save the changes, select this field and then press <Enter>. A dialog box will appear. Select Yes to reset the system after saving all changes made.

**Discard Changes and Reset**

To discard the changes, select this field and then press <Enter>. A dialog box will appear. Select Yes to reset the system setup without saving any changes.

**Restore Defaults**

To restore and load the optimized default values, select this field and then press <Enter>. A dialog box will appear. Select Yes to restore the default values of all the setup options.

**Boot Override**

Move the cursor to an available boot device and press Enter, and then the system will immediately boot from the selected boot device. The Boot Override function will only be effective for the current boot. The “Boot Option Priorities” configured in the Boot menu will not be changed.

- **Save Setting to file** Select this option to save BIOS configuration settings to a USB flash device.
- **Restore Setting from file** This field will appear only when a USB flash device is detected. Select this field to restore setting from the USB flash device.

## ► Updating the BIOS

To update the BIOS, you will need the new BIOS file and a flash utility. Please contact technical support or your sales representative for the files and specific instructions about how to update BIOS with the flash utility.

## ► Notice: BIOS SPI ROM

1. The Intel® Management Engine has already been integrated into this system board. Due to the safety concerns, the BIOS (SPI ROM) chip cannot be removed from this system board and used on another system board of the same model.
2. The BIOS (SPI ROM) on this system board must be the original equipment from the factory and cannot be used to replace one which has been utilized on other system boards.
3. If you do not follow the methods above, the Intel® Management Engine will not be updated and will cease to be effective.



**Note:**

- a. You can take advantage of flash tools to update the default configuration of the BIOS (SPI ROM) to the latest version anytime.
- b. When the BIOS IC needs to be replaced, you have to populate it properly onto the system board after the EEPROM programmer has been burned and follow the technical person's instructions to confirm that the MAC address should be burned or not.