



KSM-AL Installation Guide



Package Contents

- | |
|---|
| • One 7", 15", 19", or 21.5" Modular Touch Panel PC |
| • 3-pin and 2-pin Terminal Block Connectors |
| • SATA and Mini PCIe Installation Screws |

DFI reserves the right to change the specifications at any time prior to the product's release. For the latest revision and more details of the installation procedure, please refer to the user's manual on the website.

Panel

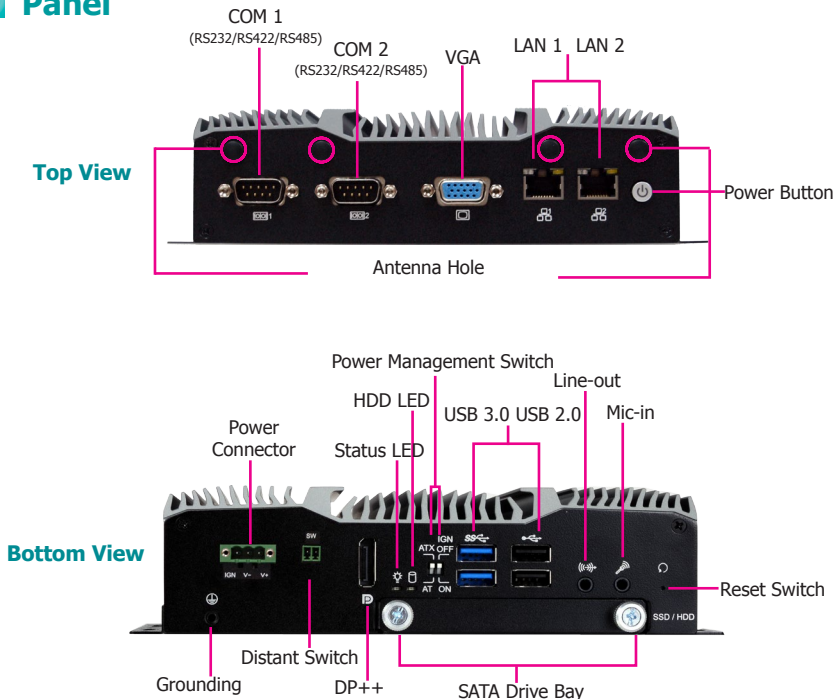

Notes on Power Management Settings:

1. AT Mode: The system powers on when power is applied.
2. ATX Mode: The system powers on via the power button or the auto power-on setting in the BIOS.
3. IGN Mode: The system powers on via the ignition control with settings of on/off delay in the BIOS, plus low-voltage protection (i.e. the system will not power on if the car battery's voltage is below 10.5, 21V and 42V for 12V input, 24V and 48V input respectively). Note that for this mode to work, please switch the AT/ATX mode to ATX. Also note this mode is not available for systems with a DC-in jack (optional).

Front OSD Functions

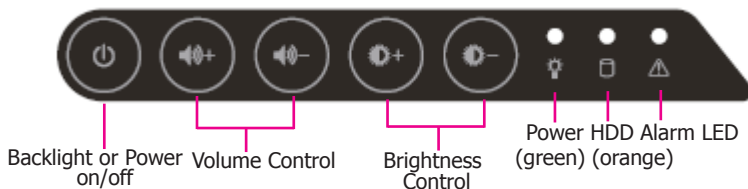

Notes on OSD Settings:

1. System Power On/Off: Press the Backlight on/off button for 3 seconds.
2. Light Sensor On/Off: Press the Brightness up arrow for 3 seconds.
3. OSD Lock/Unlock: Press the Brightness down arrow for 3 seconds.
4. Both the Status LED (on the box module) and Power LED (on the front OSD) will flash when the power on/off delay has been set in the BIOS.

Installing a SIM Card

The SIM card socket can be accessed without opening the chassis. It is located on the side of the box module.

1. Remove the screw to open the slot.

Side View



SIM Card Slot Screw

2. Insert the SIM card into the slot. Please place the card with the IC facing down and the angled corner facing toward the socket so that it will be in contact with the system board.



Note:

Make sure that the SIM card is inserted completely into the socket; you should feel a force of the spring that locks the card in place. To release the card, push it inward to unlock it.

Installing a SATA Drive

The SATA drive tray can be easily accessed without opening the system. However, the system does not support hot-swapping hard drives; turn off the system first.

1. Locate the drive tray on the bottom panel and open it by releasing the thumbscrews.



2. Position the HDD on the drive tray and align the mounting holes of the HDD with the mounting holes of the drive tray.

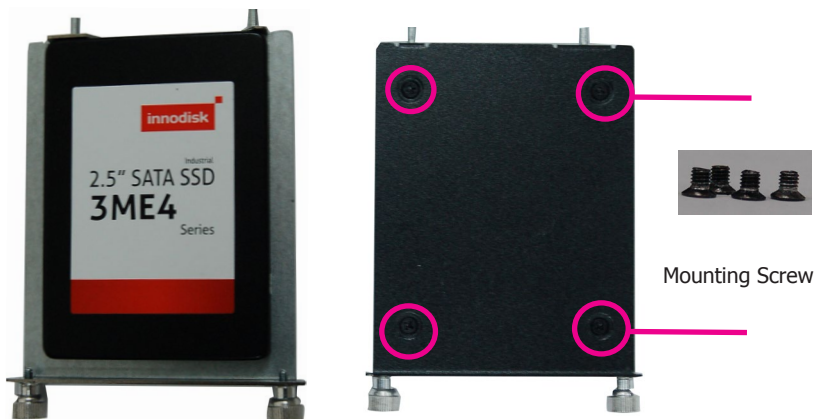

- Slide the HDD into the drive bay by aligning the HDD's data and power connectors with the system's SATA data and power connectors. Then close the drive tray and secure the drive in place with the thumbscrews.

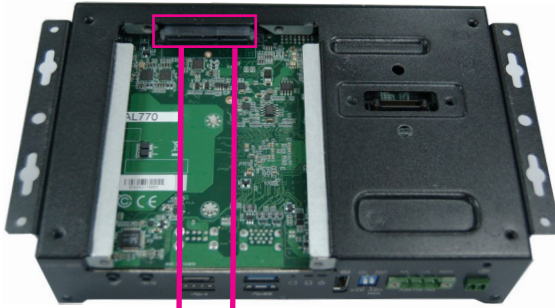

SATA Power / Data Cable

Removing the Chassis Cover

Installing internal components requires you to remove the chassis. Please use the following procedure to open the chassis cover.

1. Make sure the system and all other peripheral devices connected to it have been powered-off.
2. Disconnect all power cords and cables.
3. The 4 mounting screws on the rear side of the system are used to secure the cover to the chassis. Remove these screws and put them in a safe place for later use.

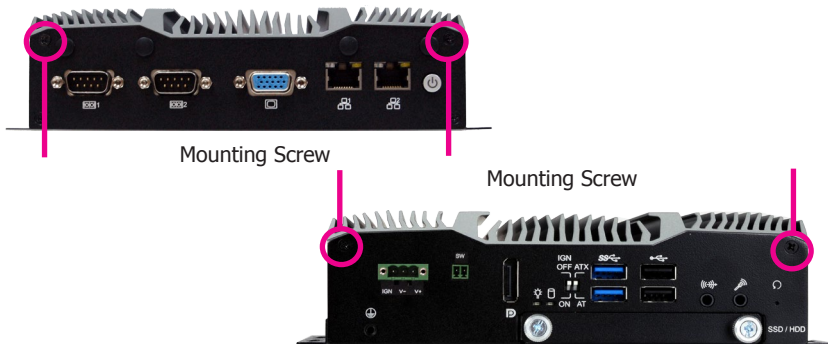

4. Lift the cover to open the system.
5. The Mini PCIe and the SODIMM slots are readily accessible after removing the chassis cover.

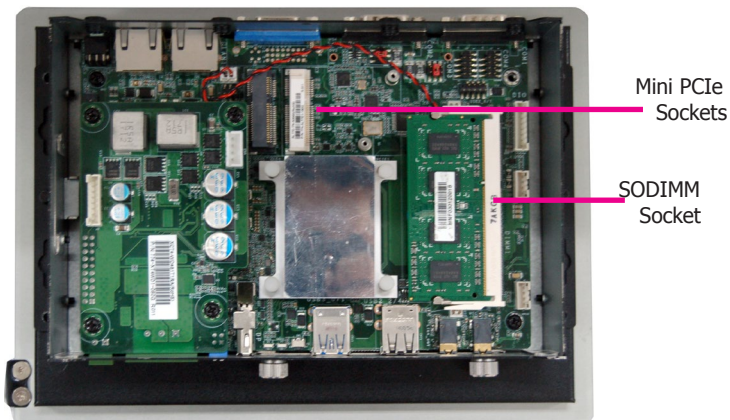

Installing a Mini PCIe Card/mini-mSATA

The system board is equipped with 2 Mini PCIe slots: one full-size (black) and one half-size (white) slots. Here we will demonstrate the installation of a full-size Mini PCIe card (working in conjunction with a SIM card) for 3G/4G connectivity.

1. Grasp the Mini PCIe card by its edges and align the notch in the connector of the PCIe card with the notch in the connector on the system board.

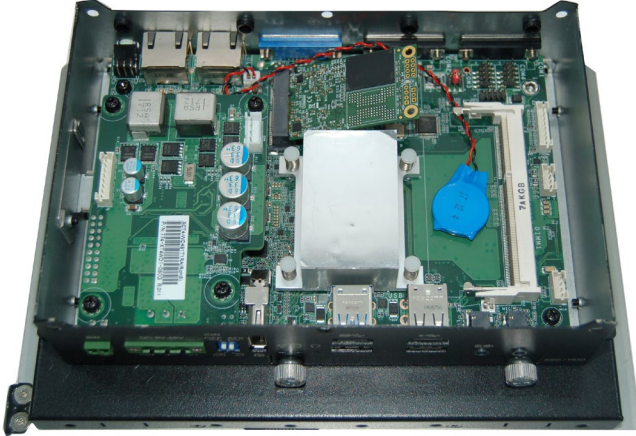

2. Push the Mini PCIe card down and use the provided mounting screws to secure the card on the system board.



Note:

The system also has one additional half-size Mini PCIe slot that supports Mini PCIe and mSATA interfaces. You can switch between these interfaces via the BIOS setup utility.

Installing a SODIMM

The system supports one DDR3L SODIMM socket. To install a memory module, grasp the memory module by its edges and align the module's notch with the socket's notch; then insert the memory into the socket at an angle and push it down until you feel a click.

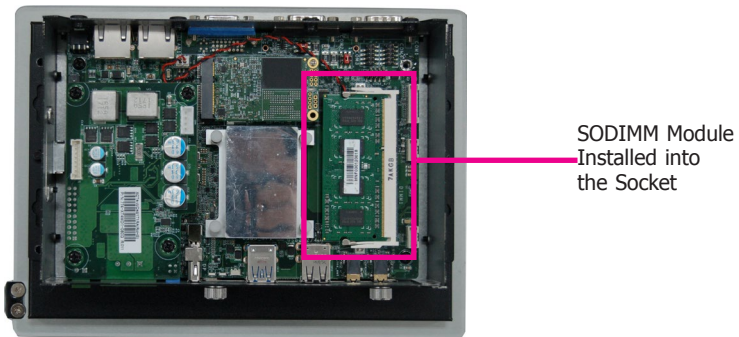
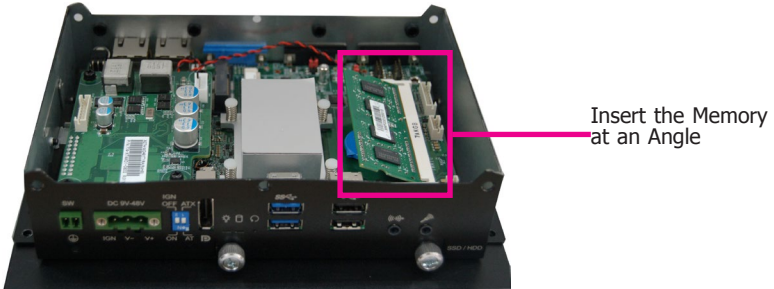



Assembling the Modular Panel PC

The modular panel PC comprises two parts: a box module and a panel module. The assembly of these two parts is easy thanks to DFI's ADP (Adaptive Display Platform) innovation, which makes the box modules and the panel modules interchangeable.

1. Take off the cover of the ADP connector of the box module.

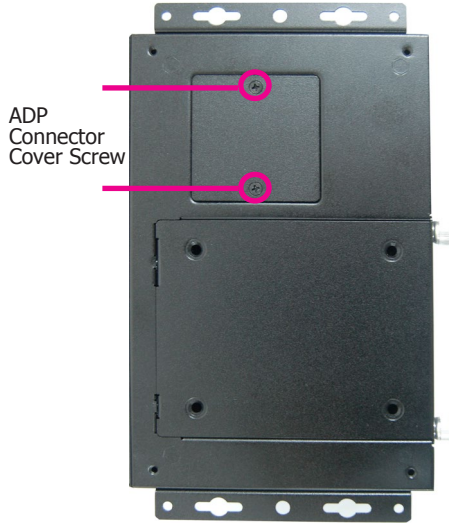

2. Hold the box module with its ADP connector in line with the ADP connector of the panel module. Align the box module with the panel module using the alignment posts.

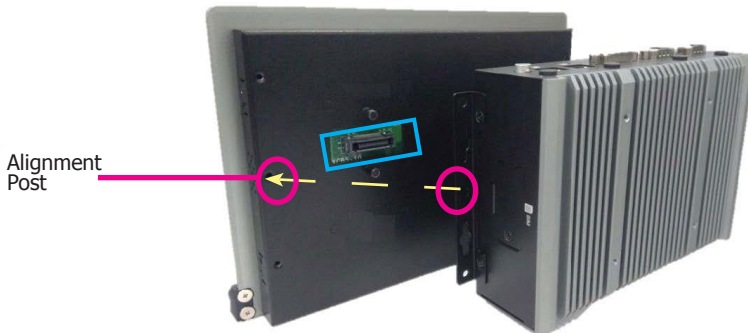

Note:

If the orientation of the assembly is not correct, the box module will not seat evenly on top of the panel module, which results in some space in between them and indicates that the ADP connectors are not engaged. When this is the case, please turn the box module the other way around.

3. Make sure that the box module seats on top of the panel module with the alignment post effortlessly slipping into the designated holes on the box module. Press to install these two modules and secure the installation with 4 mounting screws.

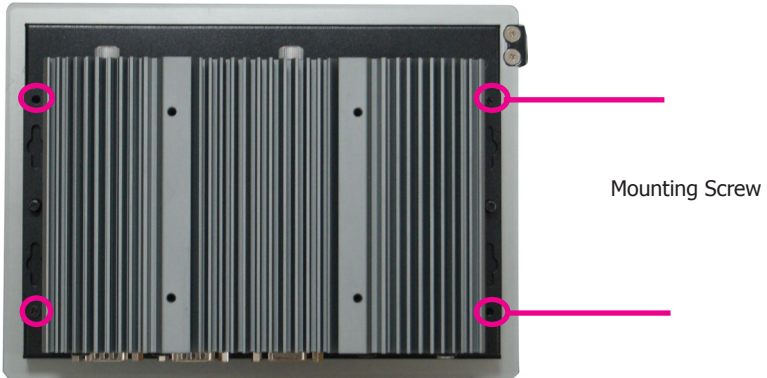



Mounting Options



Wall mount

The VESA-mount specifications for this device is 75 x 75 (mm). Please use a compatible VESA mount kit that can sustain the weight and size of this device.



Wall Mount Bracket 1



Wall Mount Bracket 2

1. Before starting any installation procedures, attach the poron foam to the Panel PC.

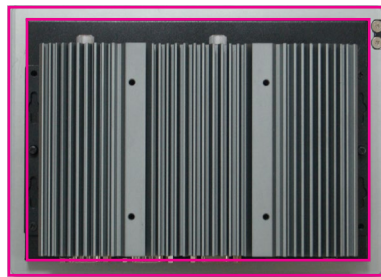

Poron Foam

2. Select a place on the wall where you will mount the Panel PC.
3. Use the provided mounting screws to attach "wall mount bracket 1" to the wall.

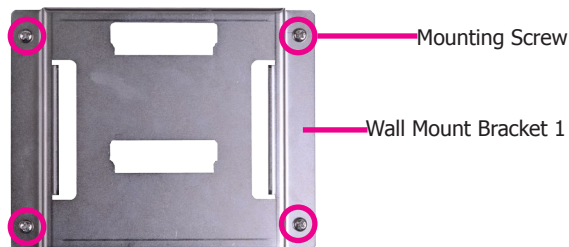

- Attach the other bracket (wall mount bracket 2) to the rear of the Panel PC.

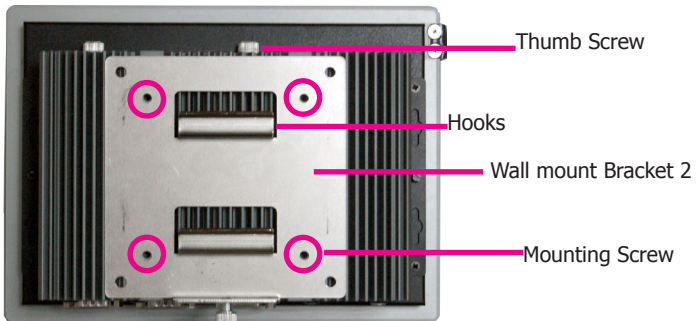

- Slide the Panel PC to "wall mount bracket 1" to attach the two brackets with the hooks. Then tighten the thumb screw to secure the assembly in place. Note that the following diagram is for illustration only and may not resemble the actual product.

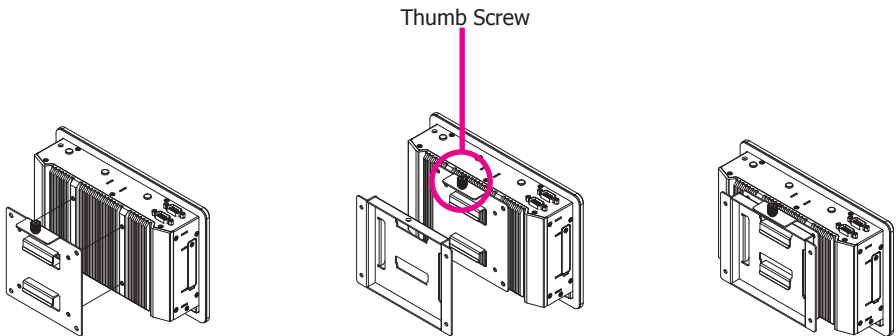

Panel mount

The panel mounting kit includes the following:

- 10 mounting clamps



1. Before starting any installation procedures, attach the poron foam to the Panel PC.

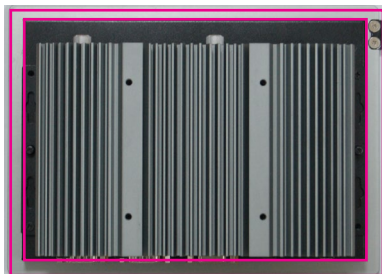

2. Select a place on the panel (or wall) where you will mount the Panel PC.
3. Cut out a shape on the panel that corresponds to the Panel PC's rear dimensions (7": 206mm x 145.6mm; 15": 367mm x 300mm; 19": 447mm x 380mm; 21.5": 526.2mm x 342.6mm) and ensure that the Panel PC can be fitted into the panel properly.

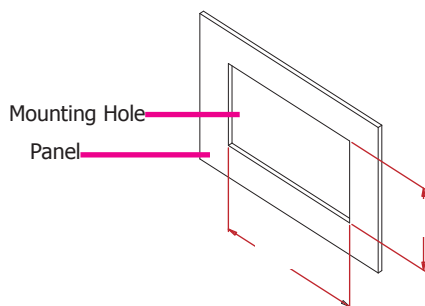

4. Insert the Panel PC from the outside surface of the panel into the mounting hole until it is properly fitted against the panel.
5. Position the mounting clamps along the rear edges of the Panel PC and insert them into the slits around the Panel PC.

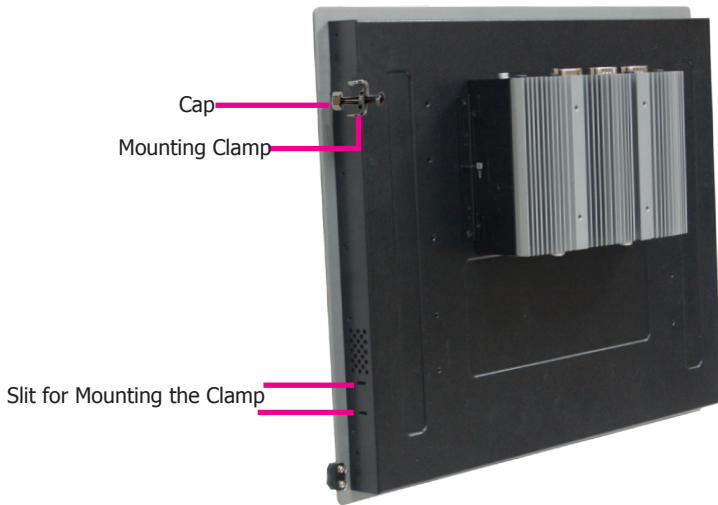

- The first and second clamps must be positioned and secured diagonally prior to mounting the rest of the clamps. Tighten the clamp's screw using an electric screwdriver by pressing the white plastic cap onto the back of the panel. Note that the following diagram is for illustration only and may not resemble the actual product.

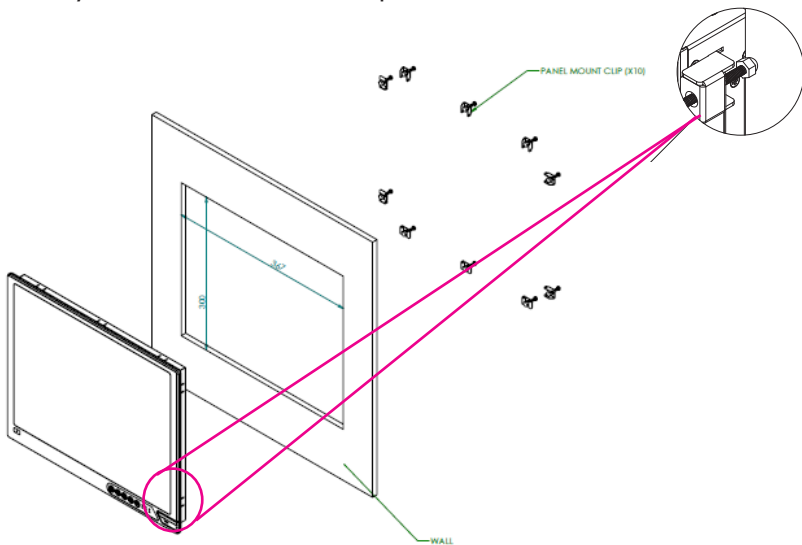

Note:

The maximum thickness of your panel's mounting wall should be 10 mm for secure panel mount.

Board Layout and Jumper Settings

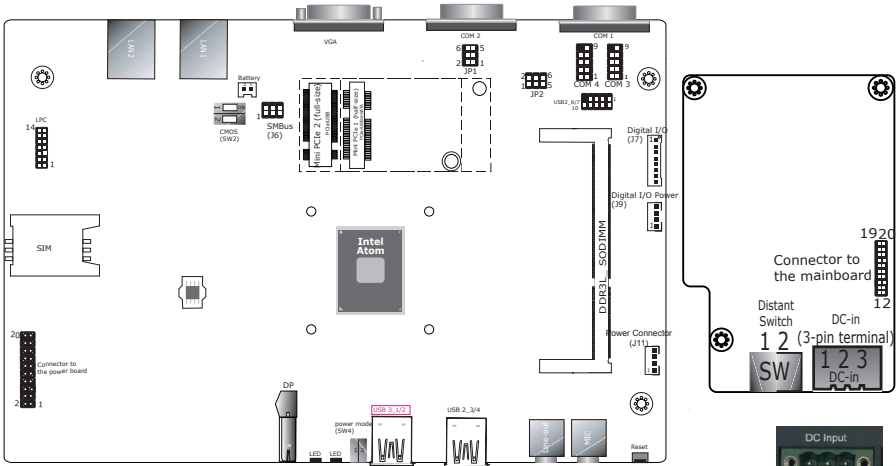

1	+12V	2	GND
3	5VSB	4	+5V

1	V+	2	V-	3	IGN
---	----	---	----	---	-----

RS232 (default)	3-4 (RI: No.9 pin)
RS232 with power	5-6 (+5V), 1-2 (+12V) On

1	PowerBNT	2	GND
---	----------	---	-----

	SW2
Normal (default)	SW2-2 Off
Clear CMOS	SW2-2 On

	SW4
Power on via Ignition	On/Off (default)
Power-on via AT/ATX power	On (AT)/ Off (ATX, default)

1	3V3SB	2	Ground
3	SMB_CLK	4	SMB_DATA
5	SMBALERT-	6	NC

1	12V	2	5V
3	Ground	4	Ground

1	DCD	2	RXD
3	TXD	4	DTR
5	GND	6	DSR
7	RTS	8	CTS
9	RI		

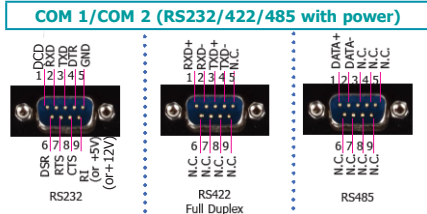

1	DIO0	2	DIO1
3	DIO2	4	DIO3
5	DIO4	6	DIO5
7	DIO6	8	DIO7

1	VCC	2	VCC
3	Data0-	4	Data1-
5	Data0+	6	Data1+
7	Ground	8	Ground
9	Key	10	NC

Note: To clear CMOS, power off the system and adjust SW2-2 to "on" for 3 seconds and back to "off", and then power on the system.

Ignition Power-on/off Delay Settings

The system comes with in-vehicle power management. The BIOS setup utility can be used to turn on or off the system with a specific on/off delay time. Use the following procedure to enable this function.

1. Press "Delete" to enter the BIOS menu when the system powers on.
2. Go to "Advanced" > "IGN Configuration."

IGN Mode Low Voltage Protection: Enables low-voltage protection to protect your car battery (default: Enabled).

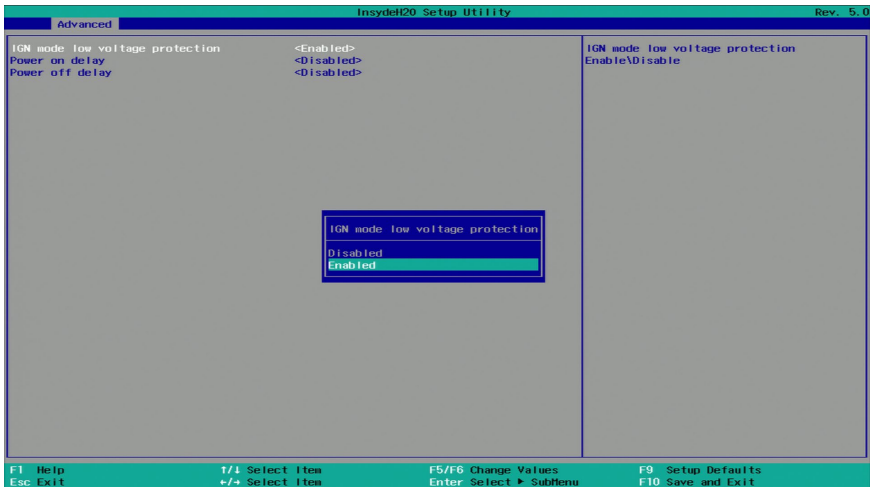

Power on/Power off Delay: Enables it to allow the system to power on or off after the specified number of seconds (default: Disabled).

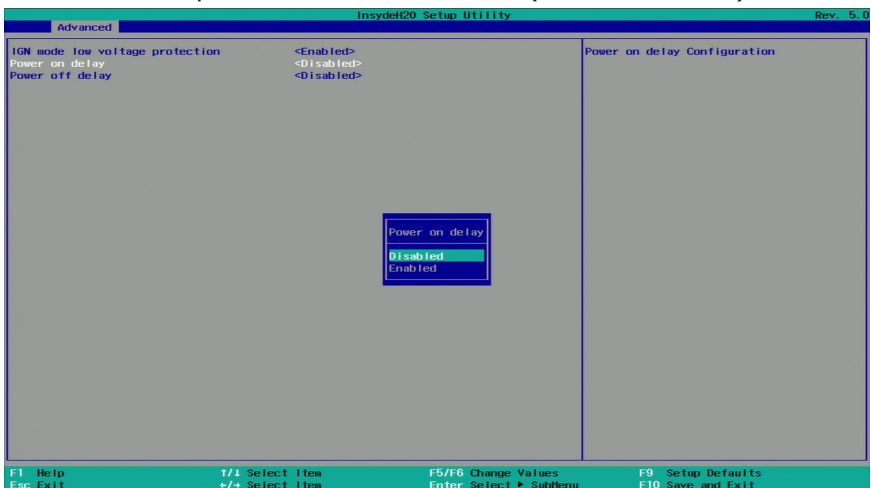

Power on/Power off Delay Time: Specify the number of seconds after which the system will start the power-on or power-off process.

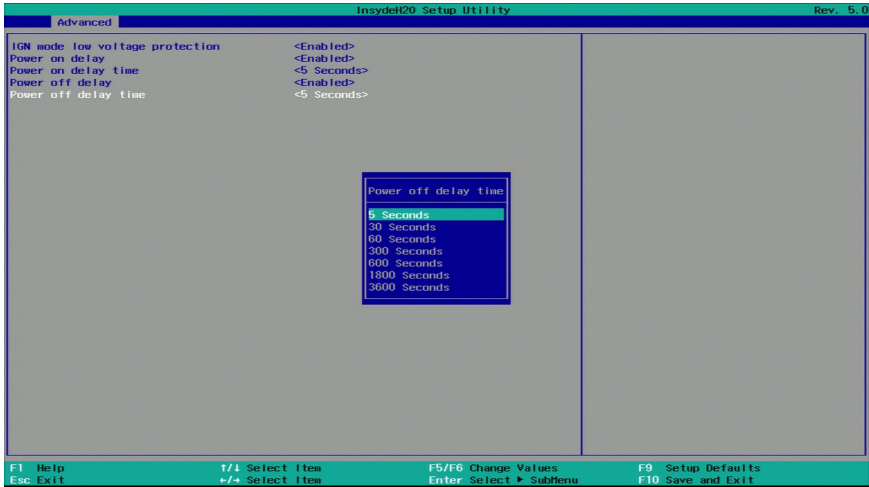

Notes:

1. Please save your changes of the BIOS settings: Exit-> Exit Saving Changes.
2. The "Status LED" on the bottom panel will start blinking once the above settings take effect.
3. Please refer to the next page for system on/off process with in-vehicle power management.

Flowcharts for Ignition Power Control

These flowcharts illustrate the startup and shutdown processes that the system goes through using ignition power control.

System startup with power management setting set to IGN mode (please refer to page 2)

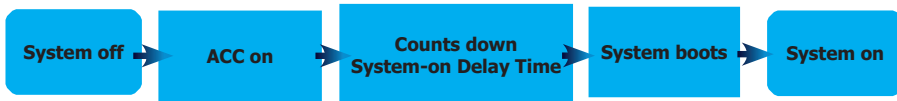

System shutdown with power management setting set to IGN mode (please refer to page 2)

