



# **EC541-HD/EC550-HD EC551-HD/EC553-DL**

## **Modular-Designed Embedded System User's Manual**

## Copyright

This publication contains information that is protected by copyright. No part of it may be reproduced in any form or by any means or used to make any transformation/adaptation without the prior written permission from the copyright holders.

This publication is provided for informational purposes only. The manufacturer makes no representations or warranties with respect to the contents or use of this manual and specifically disclaims any express or implied warranties of merchantability or fitness for any particular purpose. The user will assume the entire risk of the use or the results of the use of this document. Further, the manufacturer reserves the right to revise this publication and make changes to its contents at any time, without obligation to notify any person or entity of such revisions or changes.

Changes after the publication's first release will be based on the product's revision. The website will always provide the most updated information.

© 2018. All Rights Reserved.

## Trademarks

Product names or trademarks appearing in this manual are for identification purpose only and are the properties of the respective owners.

## FCC and DOC Statement on Class A

This equipment has been tested and found to comply with the limits for a Class A digital device, pursuant to Part 15 of the FCC rules. These limits are designed to provide reasonable protection against harmful interference when the equipment is operated in a residential installation. This equipment generates, uses and can radiate radio frequency energy and, if not installed and used in accordance with the instruction manual, may cause harmful interference to radio communications. However, there is no guarantee that interference will not occur in a particular installation. If this equipment does cause harmful interference to radio or television reception, which can be determined by turning the equipment off and on, the user is encouraged to try to correct the interference by one or more of the following measures:

- Reorient or relocate the receiving antenna.
- Increase the separation between the equipment and the receiver.
- Connect the equipment into an outlet on a circuit different from that to which the receiver is connected.
- Consult the dealer or an experienced radio TV technician for help.

### Notice:

1. The changes or modifications not expressly approved by the party responsible for compliance could void the user's authority to operate the equipment.
2. Shielded interface cables must be used in order to comply with the emission limits.

## Table of Contents

Copyright.....	2
Trademarks.....	2
FCC and DOC Statement on Class A.....	2
About this Manual.....	4
Warranty.....	4
Static Electricity Precautions.....	4
Safety Measures.....	4
Safety Precautions.....	5
About the Package.....	5
Chapter 1 - Introduction.....	6
Overview.....	6
Key Features.....	6
Specifications.....	7
Getting the Know the EC541/EC550/EC551-HD and EC553-DL.....	10
Mechanical Dimensions.....	11
Chapter 2 - Getting Started.....	14
Preparing the system.....	14
Installing Devices.....	14
Configuring the BIOS.....	14
Installing the Operating System.....	14
Installing the Drivers.....	14
Chapter 3 - Installing the Devices.....	15
Removing the Chassis Cover.....	15
Installing the SODIMM.....	16
Installing the 2.5" SATA Drive.....	17
Installing the Mini PCIe and/or mSATA Card.....	19
Installing the PCI and PCIe Expansion Cards.....	20
Chapter 4 - Jumper Settings.....	28
Jumper Setting - System Board	
Clear CMOS Data.....	28
USB Power Select.....	28
Auto Power-on Select.....	29
PS/2 Keyboard/Mouse Power Select.....	29
COM 1/COM 2 RS232/422/485 Select.....	30
COM 1/COM 2 RS232/Power Select.....	31
Mini PCIe Signal Select.....	31
Mini PCIe Power Select.....	32
Jumper Setting - I/O Board (for EC541-HD)	
USB Power Select.....	32
COM 7 to COM 10 RS232/422/485 Select.....	33
COM 7 to COM 10 RS232/Power Select.....	34
Digital I/O Power Select.....	34

Digital I/O Output State.....	35
Jumper Setting - I/O Board (for EC550-HD/EC551-HD/EC553-DL)	
USB Power Select.....	35
COM 7/COM 9 RS232/422/485 Select.....	36
COM 7/COM 9 RS232/Power Select.....	37
Digital I/O Power Select.....	37
Digital I/O Output State.....	38

### Chapter 5 - Ports and Connectors..... 39

Front Panel I/O Ports.....	39
VGA Port.....	40
RJ45 LAN Ports.....	40
USB Ports.....	41
COM (Serial) Ports.....	42
DC-in.....	43
8-bit GPIO.....	43
Audio jacks (for EC541-HD).....	44
DVI-D Port.....	44
DP Port.....	45
I/O Connectors.....	45
Power Connector.....	45
Parallel Connector.....	46
Front Panel Connector.....	46
Cooling Fan Connectors.....	47
SMBus Connector.....	48
Chassis Intrusion Connector.....	48
SATA (Serial ATA) Connectors.....	49
SATA (Serial ATA) Power Connectors.....	49
PS/2 Keyboard/Mouse Connector.....	50
Expansion Slots.....	51
Standby Power LED.....	52
Battery.....	52

### Chapter 6 - Mounting Options..... 53

### Chapter 7 - BIOS Setup..... 56

Overview.....	56
AMI BIOS Setup Utility.....	57
Main.....	57
Advanced.....	57
Chipset.....	67
Boot.....	74
Security.....	75
Save & Exit.....	76
Updating the BIOS.....	76
Notice: BIOS SPI ROM.....	77

### Chapter 8 - Supported Software..... 78

### Chapter 9 - Digital I/O Programming Guide..... 99

### Appendix A - Watchdog Sample Code..... 101

### Appendix B - System Error Message..... 102

### Appendix C - Troubleshooting..... 103

## About this Manual

An electronic file of this manual can be obtained from the DFI website at [www.dfi.com](http://www.dfi.com). To download the user's manual from our website, please go to "Support" > "Download Center." On the Download Center page, select your product or type the model name and click "Search" to find all technical documents including the user's manual for a specific product.

## Warranty

1. Warranty does not cover damages or failures that arised from misuse of the product, inability to use the product, unauthorized replacement or alteration of components and product specifications.
2. The warranty is void if the product has been subjected to physical abuse, improper installation, modification, accidents or unauthorized repair of the product.
3. Unless otherwise instructed in this user's manual, the user may not, under any circumstances, attempt to perform service, adjustments or repairs on the product, whether in or out of warranty. It must be returned to the purchase point, factory or authorized service agency for all such work.
4. We will not be liable for any indirect, special, incidental or consequential damages to the product that has been modified or altered.

## Static Electricity Precautions

It is quite easy to inadvertently damage your PC, system board, components or devices even before installing them in your system unit. Static electrical discharge can damage computer components without causing any signs of physical damage. You must take extra care in handling them to ensure against electrostatic build-up.

1. To prevent electrostatic build-up, leave the system board in its anti-static bag until you are ready to install it.
2. Wear an antistatic wrist strap.
3. Do all preparation work on a static-free surface.
4. Hold the device only by its edges. Be careful not to touch any of the components, contacts or connections.
5. Avoid touching the pins or contacts on all modules and connectors. Hold modules or connectors by their ends.



### Important:

Electrostatic discharge (ESD) can damage your processor, disk drive and other components. Perform the upgrade instruction procedures described at an ESD workstation only. If such a station is not available, you can provide some ESD protection by wearing an antistatic wrist strap and attaching it to a metal part of the system chassis. If a wrist strap is unavailable, establish and maintain contact with the system chassis throughout any procedures requiring ESD protection.

## Safety Measures

To avoid damage to the system:

- Use the correct AC input voltage range.

To reduce the risk of electric shock:

- Unplug the power cord before removing the system chassis cover for installation or servicing. After installation or servicing, cover the system chassis before plugging the power cord.

Battery:

- Danger of explosion if battery incorrectly replaced.
- Replace only with the same or equivalent type recommend by the manufacturer.
- Dispose of used batteries according to local ordinance.

## Safety Precautions

- Use the correct DC input voltage range.
- Unplug the power cord before removing the system chassis cover for installation or servicing. After installation or servicing, cover the system chassis before plugging the power cord.
- Danger of explosion if battery incorrectly replaced.
- Replace only with the same or equivalent type recommend by the manufacturer.
- Dispose of used batteries according to local ordinance.
- Keep this system away from humidity.
- Place the system on a stable surface. Dropping it or letting it fall may cause damage.
- The openings on the system are for air ventilation to protect the system from overheating. **DO NOT COVER THE OPENINGS.**
- Place the power cord in such a way that it will not be stepped on. Do not place anything on top of the power cord. Use a power cord that has been approved for use with the system and that it matches the voltage and current marked on the system's electrical range label.
- If the system will not be used for a long time, disconnect it from the power source to avoid damage by transient overvoltage.
- If one of the following occurs, consult a service personnel:
  - The power cord or plug is damaged.
  - Liquid has penetrated the system.
  - The system has been exposed to moisture.
  - The system is not working properly.
  - The system dropped or is damaged.
  - The system has obvious signs of breakage.
- The unit uses a three-wire ground cable which is equipped with a third pin to ground the unit and prevent electric shock. Do not defeat the purpose of this pin. If your outlet does not support this kind of plug, contact your electrician to replace the outlet.
- Disconnect the system from the DC outlet before cleaning. Use a damp cloth. Do not use liquid or spray detergents for cleaning.

## About the Package

The package contains the following items. If any of these items are missing or damaged, please contact your dealer or sales representative for assistance.

- 1 system unit

## Optional Items

- Wall Mount kit
- Power Cord
- Power Adapter: 120W, 19V/6.31A

The board and accessories in the package may not come similar to the information listed above. This may differ in accordance to the sales region or models in which it was sold. For more information about the standard package in your region, please contact your dealer or sales representative.

## Chapter 1 - Introduction

### Overview



Front View (EC541-HD)



Front View (EC550-HD/EC551-HD/EC553-DL)

### Key Features

<b>Model Name</b>	<b>EC541-HD/EC550-HD/EC551-HD/EC553-DL</b>
<b>Processor</b>	4th Generation Intel® Core™ processors
<b>Chipset</b>	Intel® H81 Express Chipset (EC541/EC550/EC551-HD) Intel® C226 Express Chipset (EC553-DL)
<b>LAN</b>	2 LAN ports
<b>COM</b>	EC541-HD: 6 COM ports EC550-HD/EC551-HD/EC553-DL: 4 COM ports
<b>Display</b>	EC541-HD: 1 DP, 1 DVI-D, 1 VGA EC550-HD/EC551-HD/EC553-DL: 1 DP, 1 VGA
<b>USB</b>	4 Type A USB 2.0 ports 2 Type A USB 3.0 ports
<b>Audio</b>	Realtek ALC886 5.1-channel High Definition Audio
<b>GPIO</b>	1 8-bit GPIO 9-pole terminal block

## Specifications (EC541-HD)

<b>Processor System</b>	<ul style="list-style-type: none"> <li>CPU - fanless           <ul style="list-style-type: none"> <li>4th Generation Intel® Core™ processors (22nm process technology)               <ul style="list-style-type: none"> <li>Intel® Core™ i7-4770TE (8M Cache, up to 3.3 GHz); 45W</li> <li>Intel® Core™ i5-4590T (6M Cache, up to 3.0 GHz); 35W</li> <li>Intel® Core™ i5-4570TE (4M Cache, up to 3.3 GHz); 35W</li> <li>Intel® Core™ i3-4350T (4M Cache, 3.1 GHz); 35W</li> <li>Intel® Core™ i3-4340TE (4M Cache, 2.6 GHz); 35W</li> <li>Intel® Core™ i3-4330TE (4M Cache, 2.4 GHz); 35W</li> <li>Intel® Pentium® G3320TE (3M Cache, 2.3 GHz); 35W</li> <li>Intel® Celeron® G1820TE (2M Cache, 2.2 GHz); 35W</li> </ul> </li> <li>CPU - fan               <ul style="list-style-type: none"> <li>4th Generation Intel® Core™ processors (22nm process technology)                   <ul style="list-style-type: none"> <li>Intel® Core™ i7-4790S (8M Cache, up to 4.0 GHz); 65W</li> <li>Intel® Core™ i7-4770S (8M Cache, up to 3.9 GHz); 65W</li> <li>Intel® Core™ i5-4590S (6M Cache, up to 3.7 GHz); 65W</li> <li>Intel® Core™ i5-4570S (6M Cache, up to 3.6 GHz); 65W</li> <li>Intel® Core™ i3-4360 (4M Cache, 3.7 GHz); 54W</li> <li>Intel® Core™ i3-4330 (4M Cache, 3.5 GHz); 54W</li> <li>Intel® Pentium® G3420 (3M Cache, 3.2 GHz); 53W</li> <li>Intel® Celeron® G1820 (2M Cache, 2.7 GHz); 53W</li> </ul> </li> </ul> </li> </ul> </li></ul>
<b>Chipset</b>	<ul style="list-style-type: none"> <li>Intel® H81 Express chipset</li> </ul>
<b>Memory</b>	<ul style="list-style-type: none"> <li>Two 204-pin DDR3 SODIMM sockets</li> <li>Supports DDR3 1333/1600MHz</li> <li>Supports up to 16GB system memory</li> <li>Supports dual channel memory interface</li> </ul>
<b>Graphics</b>	<ul style="list-style-type: none"> <li>Intel® HD Graphics</li> <li>Display ports: 1 VGA, 1 DVI-D, 1 DP</li> <li>VGA: 24-bit, resolution up to 1920x1200 @60Hz</li> <li>DVI-D: resolution up to 1920x1200 @60Hz</li> <li>DP: resolution up to 3200x2000 @60Hz</li> <li>HDMI: 1.4a, resolution up to 4096x2304 @24Hz</li> </ul>
<b>Storage</b>	<ul style="list-style-type: none"> <li>2 2.5" SATA drive bays           <ul style="list-style-type: none"> <li>SATA 3.0 port with data transfer rate up to 6Gb/s</li> </ul> </li> <li>1 CFast socket</li> <li>Supports 1 mSATA module via the mini PCIe socket</li> </ul>
<b>Ethernet</b>	<ul style="list-style-type: none"> <li>Intel® I210 PCI Express Gigabit Ethernet controller</li> <li>Intel® I217 Gigabit Ethernet Phy</li> <li>Integrated 10/100/1000 transceiver</li> <li>Fully compliant with IEEE 802.3, IEEE 802.3u, IEEE 802.3ab</li> </ul>
<b>Audio</b>	<ul style="list-style-type: none"> <li>Realtek ALC886 5.1-channel High Definition Audio</li> <li>S/PDIF audio interface</li> </ul>
<b>Expansion</b>	<ul style="list-style-type: none"> <li>1 PCIe x16 slot</li> <li>3 PCI slots</li> <li>1 Mini PCIe slot           <ul style="list-style-type: none"> <li>Supports USB and PCIe signals</li> <li>Supports mSATA, Wi-Fi or 3G* (optional)</li> <li>Supports half size or full size Mini PCIe card</li> </ul> </li> </ul>

<b>Front Panel I/O Ports</b>	<ul style="list-style-type: none"> <li>1 power button with LED</li> <li>1 reset button</li> <li>1 Status LED</li> <li>1 HDD LED</li> <li>1 VGA port</li> <li>2 RJ45 LAN ports</li> <li>4 Type A USB 2.0 ports</li> <li>2 Type A USB 3.0 ports</li> <li>6 DB-9 RS232/422/485 serial ports (with power)</li> <li>1 9~36V DC-in 3-pole terminal block</li> <li>1 8-bit GPIO 9-pole terminal block</li> <li>Mic-in, Line-in, Line-out</li> <li>1 DVI-D port</li> <li>1 DP port</li> </ul>
<b>Power</b>	<ul style="list-style-type: none"> <li>Power input voltage: 9~36V DC-in</li> </ul>
<b>Cooling System</b>	<ul style="list-style-type: none"> <li>2 system fan</li> </ul>
<b>Environment</b>	<ul style="list-style-type: none"> <li>Temperature - fanless           <ul style="list-style-type: none"> <li>Operating: 0°C ~ 45°C</li> </ul> </li> <li>Temperature - fan           <ul style="list-style-type: none"> <li>Operating: 0°C ~ 55°C (SSD/mSATA/CFast)</li> <li>Operating: 0°C ~ 50°C (HDD)</li> <li>Storage: -20°C ~ 85°C</li> <li>Humidity: 5% ~ 90%</li> </ul> </li> <li>Operating Vibration           <ul style="list-style-type: none"> <li>IEC68-2-64</li> </ul> </li> <li>Operating Shock           <ul style="list-style-type: none"> <li>Half sine wave 3G, 11ms, 3 shock per axis</li> </ul> </li> </ul>
<b>Construction</b>	<ul style="list-style-type: none"> <li>Aluminum + SGCC</li> </ul>
<b>Mounting</b>	<ul style="list-style-type: none"> <li>Wall mount           <ul style="list-style-type: none"> <li>Mounting brackets and screws* (optional)</li> </ul> </li> </ul>
<b>Dimensions</b>	<ul style="list-style-type: none"> <li>235mm x 208.2mm x 222mm (W x H x D)</li> </ul>
<b>Weight</b>	<ul style="list-style-type: none"> <li>5.3kg</li> </ul>
<b>OS Support</b>	<ul style="list-style-type: none"> <li>Windows XP (32-bit) (limited function), Windows 7, WES 7, Windows 8.1, WE8S</li> <li>Linux (Distribution available upon request)</li> </ul>
<b>Other Features</b>	<ul style="list-style-type: none"> <li>Watchdog timeout programmable via software from 1 to 255 seconds</li> </ul>
<b>Certification</b>	<ul style="list-style-type: none"> <li>CE</li> <li>FCC Class A</li> <li>RoHS</li> </ul>

**Note:**

\*Optional and is not supported in standard model. Please contact your sales representative for more information.

## Specifications (EC550-HD/EC551-HD)

<b>Processor System</b>	<ul style="list-style-type: none"> <li>• CPU <ul style="list-style-type: none"> <li>- 4th Generation Intel® Core™ processors (22nm process technology) <ul style="list-style-type: none"> <li>: Intel® Core™ i7-4790S (8M Cache, up to 4.0 GHz); 65W</li> <li>: Intel® Core™ i7-4770S (8M Cache, up to 3.9 GHz); 65W</li> <li>: Intel® Core™ i7-4770TE (8M Cache, up to 3.3 GHz); 45W</li> <li>: Intel® Core™ i5-4590S (6M Cache, up to 3.7 GHz); 65W</li> <li>: Intel® Core™ i5-4590T (6M Cache, up to 3.0 GHz); 35W</li> <li>: Intel® Core™ i5-4570S (6M Cache, up to 3.6 GHz); 65W</li> <li>: Intel® Core™ i5-4570TE (4M Cache, up to 3.3 GHz); 35W</li> <li>: Intel® Core™ i3-4360 (4M Cache, 3.7 GHz); 54W</li> <li>: Intel® Core™ i3-4350T (4M Cache, 3.1 GHz); 35W</li> <li>: Intel® Core™ i3-4340TE (4M Cache, 2.6 GHz); 35W</li> <li>: Intel® Core™ i3-4330 (4M Cache, 3.5 GHz); 54W</li> <li>: Intel® Core™ i3-4330TE (4M Cache, 2.4 GHz); 35W</li> <li>: Intel® Pentium® G3420 (3M Cache, 3.2 GHz); 53W</li> <li>: Intel® Pentium® G3320TE (3M Cache, 2.3 GHz); 35W</li> <li>: Intel® Celeron® G1820 (2M Cache, 2.7 GHz); 53W</li> <li>: Intel® Celeron® G1820TE (2M Cache, 2.2 GHz); 35W</li> </ul> </li> </ul> </li> </ul>
<b>Chipset</b>	Intel® H81 Express Chipset
<b>Memory</b>	<ul style="list-style-type: none"> <li>• Two 204-pin DDR3 SODIMM sockets</li> <li>• Supports DDR3 1333/1600MHz</li> <li>• Supports up to 16GB system memory</li> <li>• Supports dual channel memory interface</li> </ul>
<b>Graphics</b>	<ul style="list-style-type: none"> <li>• Intel® HD Graphics</li> <li>• Display ports: 1 VGA, 1 DP</li> <li>• VGA: 24-bit, resolution up to 1920x1200 @60Hz</li> <li>• DP: resolution up to 3200x2000 @60Hz</li> <li>• HDMI: 1.4a, resolution up to 4096x2304 @24Hz</li> </ul>
<b>Storage</b>	<ul style="list-style-type: none"> <li>• 2 2.5" SATA drive bays <ul style="list-style-type: none"> <li>- SATA 3.0 port with data transfer rate up to 6Gb/s</li> </ul> </li> <li>• Supports 1 mSATA module via the mini PCIe socket</li> </ul>
<b>Ethernet</b>	<ul style="list-style-type: none"> <li>• Intel® I210 PCI Express Gigabit Ethernet controller</li> <li>• Intel® I217 Gigabit Ethernet Phy</li> <li>• Integrated 10/100/1000 transceiver</li> <li>• Fully compliant with IEEE 802.3, IEEE 802.3u, IEEE 802.3ab</li> </ul>
<b>Audio</b>	<ul style="list-style-type: none"> <li>• Realtek ALC886 5.1-channel High Definition Audio</li> <li>• S/PDIF audio interface</li> </ul>
<b>Expansion</b>	<ul style="list-style-type: none"> <li>• EC550 <ul style="list-style-type: none"> <li>- 5 PCI slots</li> <li>- 1 Mini PCIe slot <ul style="list-style-type: none"> <li>: Supports USB and PCIe signals</li> <li>: Supports mSATA, Wi-Fi or 3G*</li> <li>: Supports half size or full size Mini PCIe card</li> </ul> </li> </ul> </li> </ul>

<b>Expansion</b>	<ul style="list-style-type: none"> <li>• EC551 <ul style="list-style-type: none"> <li>- 4 PCI slots</li> <li>- 1 PCIe x16 slot</li> <li>- 1 Mini PCIe slot <ul style="list-style-type: none"> <li>: Supports USB and PCIe signals</li> <li>: Supports mSATA, Wi-Fi or 3G*</li> <li>: Supports half size or full size Mini PCIe card</li> </ul> </li> </ul> </li> </ul>
<b>Front Panel I/O Ports</b>	<ul style="list-style-type: none"> <li>• 1 power button with LED</li> <li>• 1 reset button</li> <li>• 1 Status LED</li> <li>• 1 HDD LED</li> <li>• 1 VGA port</li> <li>• 1 DP port</li> <li>• 2 RJ45 LAN ports</li> <li>• 4 Type A USB 2.0 ports</li> <li>• 2 Type A USB 3.0 ports</li> <li>• 4 DB-9 RS232/422/485 serial ports (with power)</li> <li>• 1 9~36V DC-in 3-pole terminal block</li> <li>• 1 8-bit GPIO 9-pole terminal block</li> <li>• Mic-in, Line-in, Line-out</li> </ul>
<b>Power</b>	<ul style="list-style-type: none"> <li>• Power input voltage: 9~36V DC-in</li> </ul>
<b>Cooling System</b>	<ul style="list-style-type: none"> <li>• 2 system fan</li> </ul>
<b>Environment</b>	<ul style="list-style-type: none"> <li>• Temperature <ul style="list-style-type: none"> <li>- Operating: 0°C ~ 50°C</li> <li>- Storage: -20°C ~ 85°C</li> </ul> </li> <li>• Operating Vibration <ul style="list-style-type: none"> <li>- IEC68-2-64</li> </ul> </li> <li>• Operating Shock <ul style="list-style-type: none"> <li>- Half sine wave 3G, 11ms, 3 shock per axis</li> </ul> </li> </ul>
<b>Construction</b>	<ul style="list-style-type: none"> <li>• Aluminum + SGCC</li> </ul>
<b>Mounting</b>	<ul style="list-style-type: none"> <li>• Wall mount <ul style="list-style-type: none"> <li>- Mounting brackets and screws* (optional)</li> </ul> </li> </ul>
<b>Dimensions</b>	<ul style="list-style-type: none"> <li>• 235mm x 208.2mm x 222mm (W x H x D)</li> </ul>
<b>Weight</b>	<ul style="list-style-type: none"> <li>• TBD</li> </ul>
<b>OS Support</b>	<ul style="list-style-type: none"> <li>• Windows XP (32-bit) (<u>limited function</u>), Windows 7, WES 7, Windows 8.1, WE8S</li> <li>• Linux (Distribution available upon request)</li> </ul>
<b>Other Features</b>	<ul style="list-style-type: none"> <li>• Watchdog timeout programmable via software from 1 to 255 seconds</li> </ul>
<b>Certification</b>	<ul style="list-style-type: none"> <li>• CE</li> <li>• FCC Class A</li> <li>• RoHS</li> </ul>

**Note:**

\*Optional and is not supported in standard model. Please contact your sales representative for more information.



## Specifications (EC553-DL)

<b>Processor System</b>	<ul style="list-style-type: none"> <li>• CPU <ul style="list-style-type: none"> <li>- 4th Generation Intel® Xeon®/Core™ processors (22nm process technology) <ul style="list-style-type: none"> <li>: Intel® Xeon® E3-1268L v3 (8M Cache, up to 3.3 GHz); 45W</li> <li>: Intel® Core™ i7-4770S (8M Cache, up to 3.9 GHz); 65W</li> <li>: Intel® Core™ i7-4770TE (8M Cache, up to 3.3 GHz); 45W</li> <li>: Intel® Core™ i5-4570S (6M Cache, up to 3.6 GHz); 65W</li> <li>: Intel® Core™ i5-4570TE (4M Cache, up to 3.3 GHz); 35W</li> <li>: Intel® Core™ i3-4360 (4M Cache, 3.7 GHz); 54W</li> <li>: Intel® Core™ i3-4340TE (4M Cache, 2.6 GHz); 35W</li> <li>: Intel® Core™ i3-4330 (4M Cache, 3.5 GHz); 54W</li> <li>: Intel® Core™ i3-4330TE (4M Cache, 2.4 GHz); 35W</li> <li>: Intel® Pentium® G3420 (3M Cache, 3.2 GHz); 53W</li> <li>: Intel® Pentium® G3320TE (3M Cache, 2.3 GHz); 35W</li> <li>: Intel® Celeron® G1820 (2M Cache, 2.7 GHz); 53W</li> <li>: Intel® Celeron® G1820TE (2M Cache, 2.2 GHz); 35W</li> </ul> </li> </ul> </li> </ul>
<b>Chipset</b>	Intel® C226 Express Chipset
<b>Memory</b>	<ul style="list-style-type: none"> <li>• Two 204-pin DDR3 SODIMM sockets</li> <li>• Supports DDR3 1333/1600MHz</li> <li>• Supports up to 16GB system memory</li> <li>• Supports dual channel memory interface</li> </ul>
<b>Graphics</b>	<ul style="list-style-type: none"> <li>• Intel® HD Graphics</li> <li>• Display ports: 1 VGA, 1 DP</li> <li>• VGA: 24-bit, resolution up to 1920x1200 @60Hz</li> <li>• DP: resolution up to 3200x2000 @60Hz</li> <li>• HDMI: 1.4a, resolution up to 4096x2304 @24Hz</li> </ul>
<b>Storage</b>	<ul style="list-style-type: none"> <li>• 2 2.5" SATA drive bays <ul style="list-style-type: none"> <li>- SATA 3.0 port with data transfer rate up to 6Gb/s</li> </ul> </li> <li>• Supports 1 mSATA module via the mini PCIe socket</li> </ul>
<b>Ethernet</b>	<ul style="list-style-type: none"> <li>• Intel® I210 PCI Express Gigabit Ethernet controller</li> <li>• Intel® I217 Gigabit Ethernet Phy</li> <li>• Integrated 10/100/1000 transceiver</li> <li>• Fully compliant with IEEE 802.3, IEEE 802.3u, IEEE 802.3ab</li> </ul>
<b>Audio</b>	<ul style="list-style-type: none"> <li>• Realtek ALC886 5.1-channel High Definition Audio</li> <li>• S/PDIF audio interface</li> </ul>
<b>Expansion</b>	<ul style="list-style-type: none"> <li>• 2 PCI slots</li> <li>• 2 PCIe x16 slots (x8 signal)</li> <li>• 1 PCIe x4 slot (x1 signal)</li> <li>• 1 Mini PCIe slot <ul style="list-style-type: none"> <li>- Supports USB and PCIe signals</li> <li>- Supports mSATA, Wi-Fi or 3G*</li> <li>- Supports half size or full size Mini PCIe card</li> </ul> </li> </ul>

<b>Front Panel I/O Ports</b>	<ul style="list-style-type: none"> <li>• 1 power button with LED</li> <li>• 1 reset button</li> <li>• 1 Status LED</li> <li>• 1 HDD LED</li> <li>• 1 VGA port</li> <li>• 1 DP port</li> <li>• 2 RJ45 LAN ports</li> <li>• 4 Type A USB 2.0 ports</li> <li>• 2 Type A USB 3.0 ports</li> <li>• 4 DB-9 RS232/422/485 serial ports (with power)</li> <li>• 1 9~36V DC-in 3-pole terminal block</li> <li>• 1 8-bit GPIO 9-pole terminal block</li> <li>• Mic-in, Line-in, Line-out</li> </ul>
<b>Power</b>	<ul style="list-style-type: none"> <li>• Power input voltage: 9~36V DC-in</li> </ul>
<b>Cooling System</b>	<ul style="list-style-type: none"> <li>• 2 system fan</li> </ul>
<b>Environment</b>	<ul style="list-style-type: none"> <li>• Temperature <ul style="list-style-type: none"> <li>- Operating: 0°C ~ 50°C</li> <li>- Storage: -20°C ~ 85°C</li> </ul> </li> <li>• Operating Vibration <ul style="list-style-type: none"> <li>- IEC68-2-64</li> </ul> </li> <li>• Operating Shock <ul style="list-style-type: none"> <li>- Half sine wave 3G, 11ms, 3 shock per axis</li> </ul> </li> </ul>
<b>Construction</b>	<ul style="list-style-type: none"> <li>• Aluminum + SGCC</li> </ul>
<b>Mounting</b>	<ul style="list-style-type: none"> <li>• Wall mount <ul style="list-style-type: none"> <li>- Mounting brackets and screws* (optional)</li> </ul> </li> </ul>
<b>Dimensions</b>	<ul style="list-style-type: none"> <li>• 235mm x 208.2mm x 222mm (W x H x D)</li> </ul>
<b>Weight</b>	<ul style="list-style-type: none"> <li>• TBD</li> </ul>
<b>OS Support</b>	<ul style="list-style-type: none"> <li>• Windows XP (32-bit) (limited function), Windows 7, WES 7, Windows 8.1, WE8S</li> <li>• Linux (Distribution available upon request)</li> </ul>
<b>Other Features</b>	<ul style="list-style-type: none"> <li>• Watchdog timeout programmable via software from 1 to 255 seconds</li> </ul>
<b>Certification</b>	<ul style="list-style-type: none"> <li>• CE</li> <li>• FCC Class A</li> <li>• RoHS</li> </ul>

**Note:**

\*Optional and is not supported in standard model. Please contact your sales representative for more information.

## Getting to Know the EC541/EC550/EC551-HD and EC553-DL

### Front View (EC541-HD)

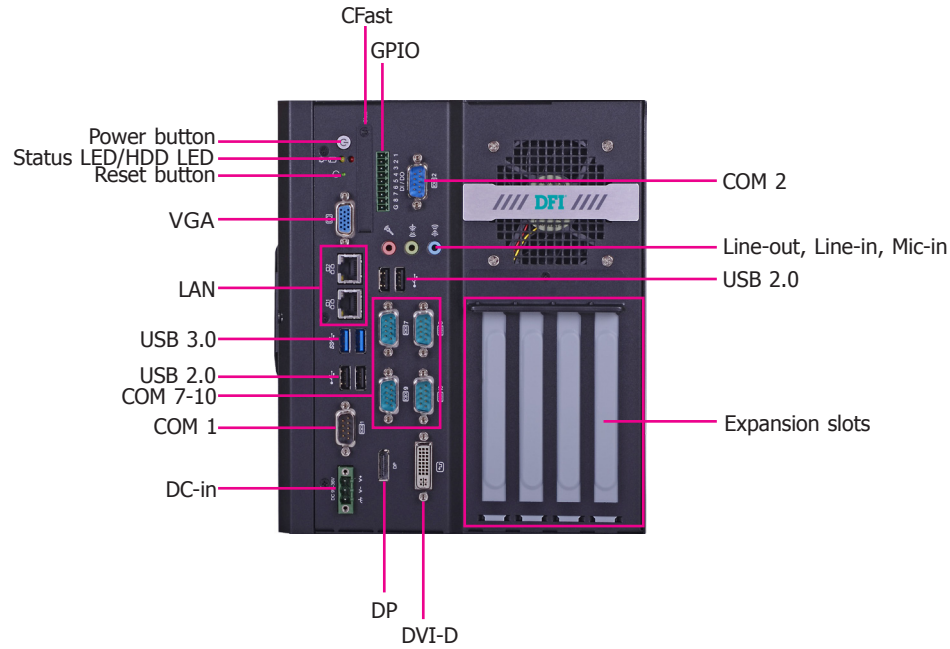

### Front View (EC550-HD/EC551-HD/EC553-DL)

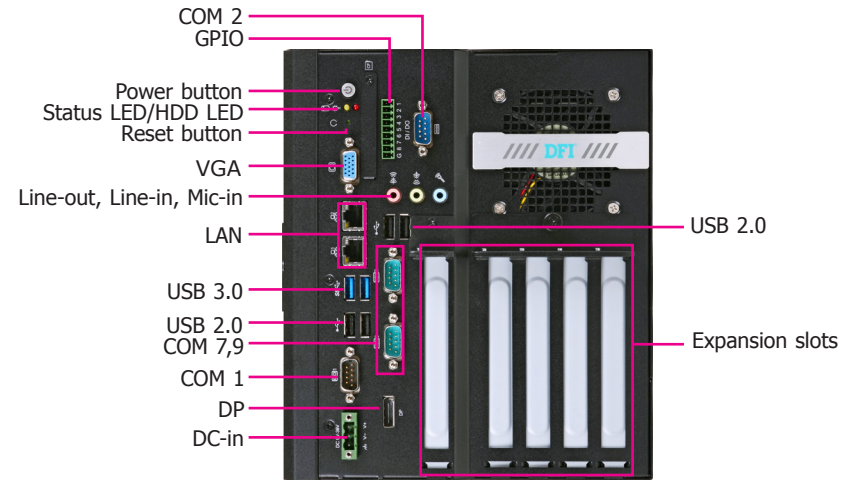

### DP Port



### DP Port



## VGA Port

Used to connect a VGA device.

## LAN Ports

Used to connect the system to a local area network.

## USB Ports

Used to connect USB 2.0/1.1 devices or USB 3.0 devices.

## COM Ports

Used to connect serial devices.

## DC-in

Used to plug a power adapter.

## DP Port

Used to connect a DP device.

## DVI-D Port

Used to connect a DVI device.

## GPIO

Supports 8-bit digital output and input.

## CFast Socket

Used to insert a CFast card.

## Line-in

Used to connect any audio devices such as Hi-fi set, CD player, tape player, AM/FM radio tuner, synthesizer, etc.

## Line-out

Used to connect to a speaker.

## Mic-in jack

Used to connect to a microphone.

## Power button

Press to power-on or power-off the system.

## Reset Button

Press to reset the system.

## HDD LED

Indicates the status of the hard drive.

## Status LED

Indicates the status as below.

Status LED				
Suspend Mode	S0	S1	S3	S4, S5
LED Action	Always ON	Quick Blink (cycle 1 sec)	Slow Blink (cycle >1 sec)	OFF

## Mechanical Dimensions

## Motherboard Dimensions

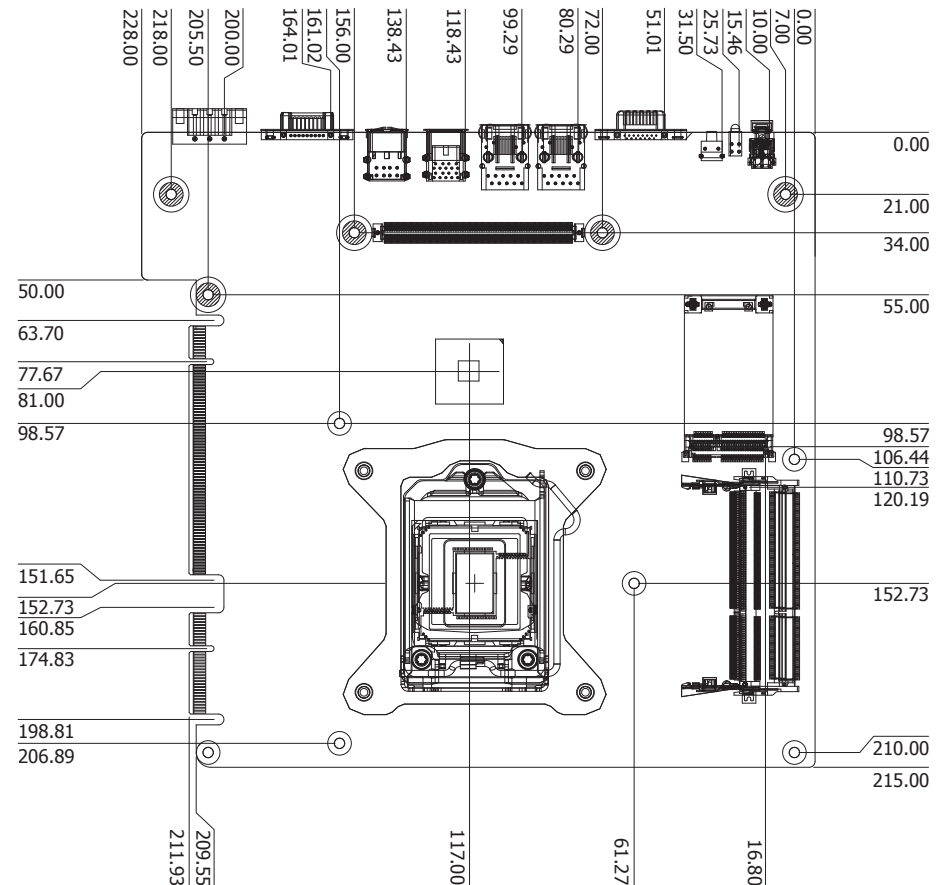

**Mechanical Dimensions**

**Chassis Dimensions (EC541-HD)**

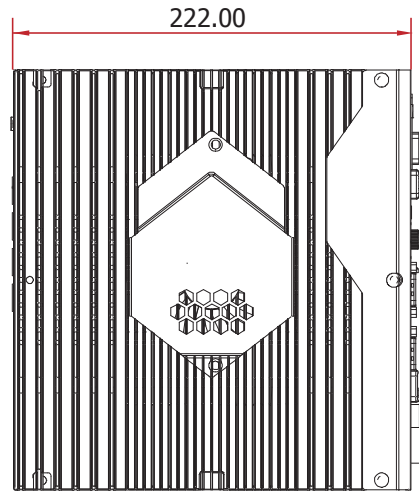

Left View

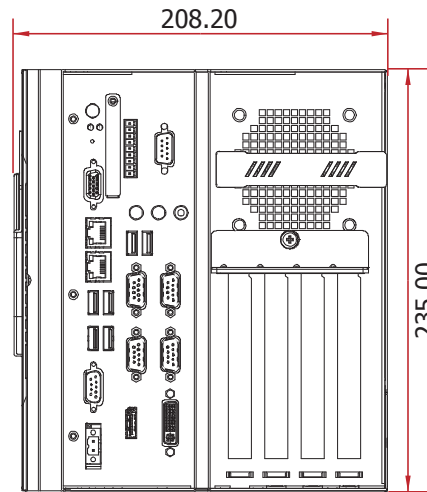

Front View

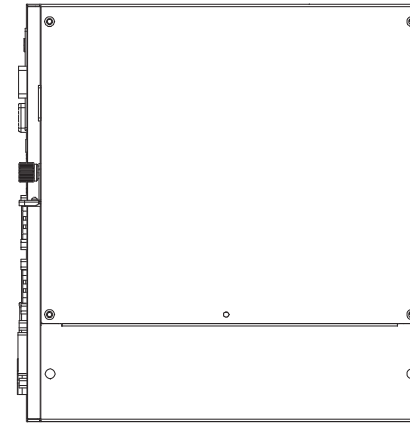

Right View

Chassis Dimensions (EC550-HD/EC551-HD/EC553-DL)

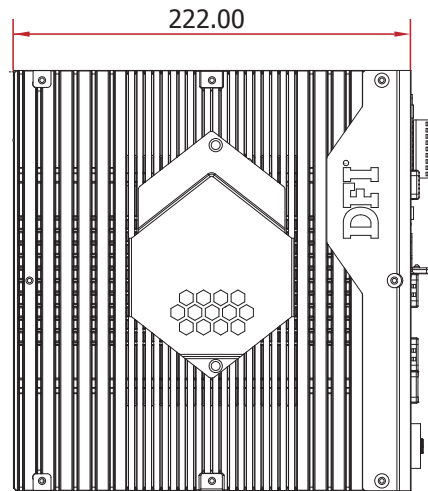

Left View

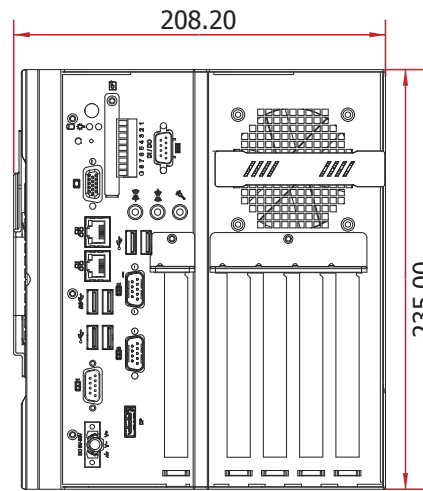

Front View

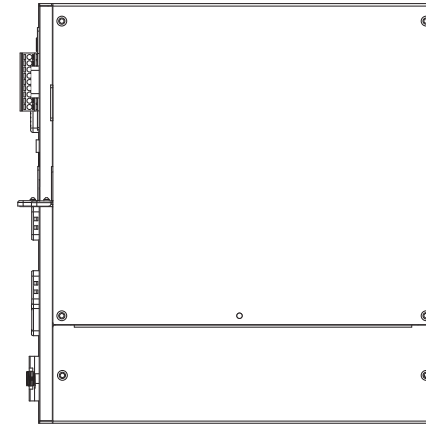

Right View

## Chapter 2 - Getting Started

---

### Preparing the System

Before you start using the system, you need the following items:

- SATA hard drive
- AC power adapter
- PS/2 or USB keyboard
- PS/2 or USB mouse
- CD-ROM drive (for installing software/drivers)
- Memory module

### Installing Devices

The following are devices that can be installed in the system.

- Memory module
- SATA hard drive
- Mini PCIe card

### Configuring the BIOS

To get you started, you may need to change configurations such as the date, time and the type of hard disk drive.

1. Power-on the system.
2. After the memory test, the message "Press DEL to run setup" will appear on the screen. Press the Delete key to enter the AMI BIOS setup utility.

### Installing the Operating System

Most operating system software can be installed using a DVD (and DVD burner) or bootable USB drive.

Please refer to your operating system manual for instructions on installing an operating system.

### Installing the Drivers

The system requires you to install drivers for some devices to operate properly. Refer to the Supported Software chapter for instructions on installing the drivers.

## Chapter 3 - Installing the Devices

### Removing the Chassis Cover

1. Make sure the system and all other peripheral devices connected to it have been powered-off.
2. Disconnect all power cords and cables.
3. The 4 mounting screws on the system chassis are used to secure the cover. Remove these screws and then put them in a safe place for later use.

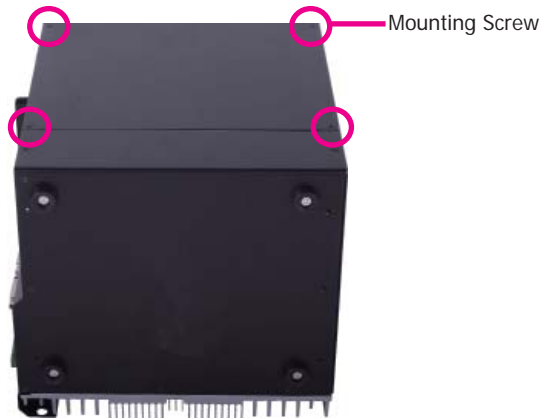

4. After removing mounting screws, lift the cover upward.

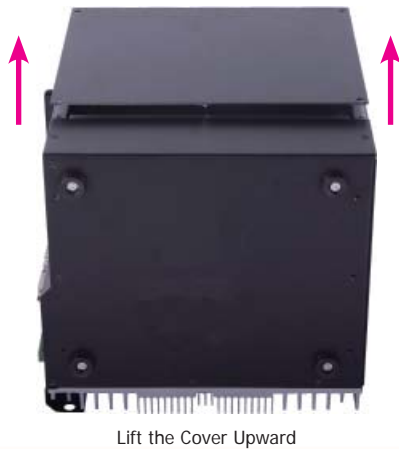

5. The SODIMM socket, Mini PCIe slot and SATA drive bay are readily accessible after removing the chassis cover.

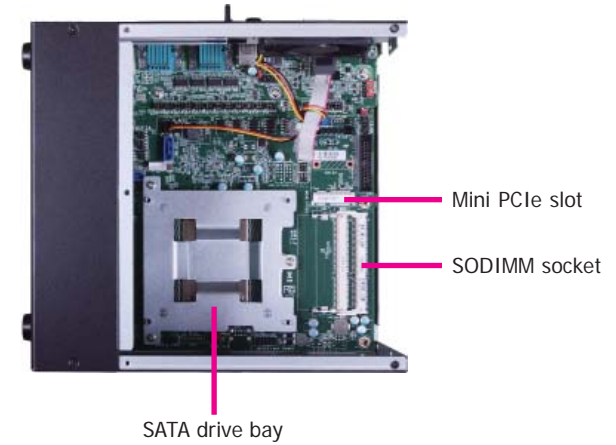

## Installing the SODIMM

1. The SODIMM sockets are located on the system board.

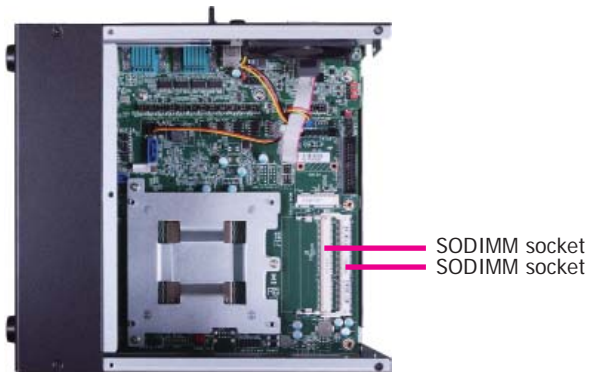

2. Note the key on the socket. The key ensures the module can be plugged into the socket in one direction only.



3. Grasping the module by its edges, align the module into the socket at an approximately 30 degrees angle. Apply firm even pressure to each end of the module until it slips down into the socket. The contact fingers on the edge of the module will almost completely disappear inside the socket.

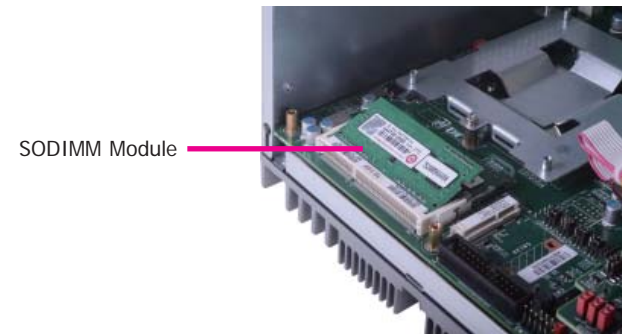

4. Push the module down until the clips at each end of the socket lock into position. You will hear a distinctive "click", indicating the module is correctly locked into the position.

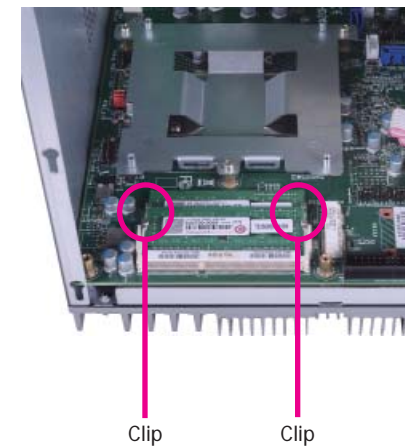



## Installing the 2.5" SATA Drive

1. The SATA drive bay is located on the system board.



SATA drive bay

2. Use the 2 provided mounting screws to secure the SATA power/data cable on the HDD bracket.

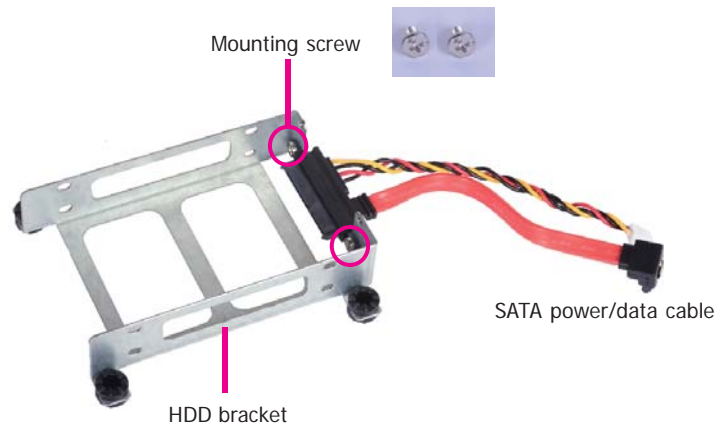

3. Connect the SATA power/data connector on the SATA drive to the SATA power/data cable secured on the HDD bracket. Then, align mounting holes of the SATA drive with mounting holes on the HDD bracket and use the provided mounting screws to secure the drive in place.

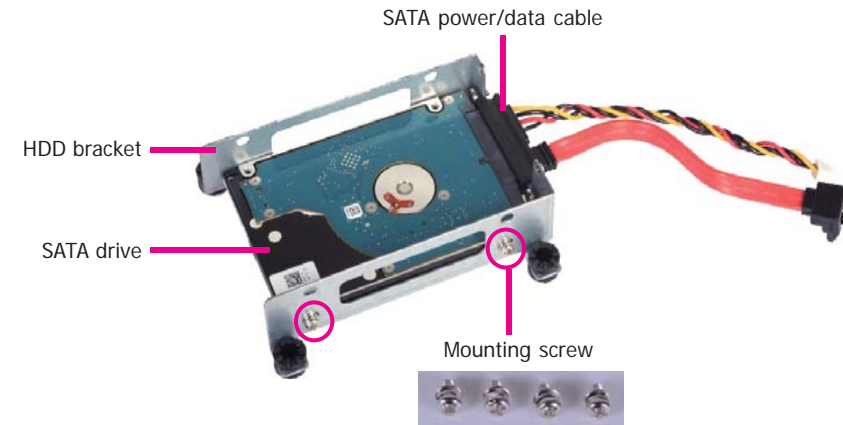

4. Place the SATA drive with the HDD bracket into the system. Align mounting holes on the HDD bracket with mounting holes on the SATA drive bay and then use the provided mounting screws to secure the drive with the HDD bracket in place.

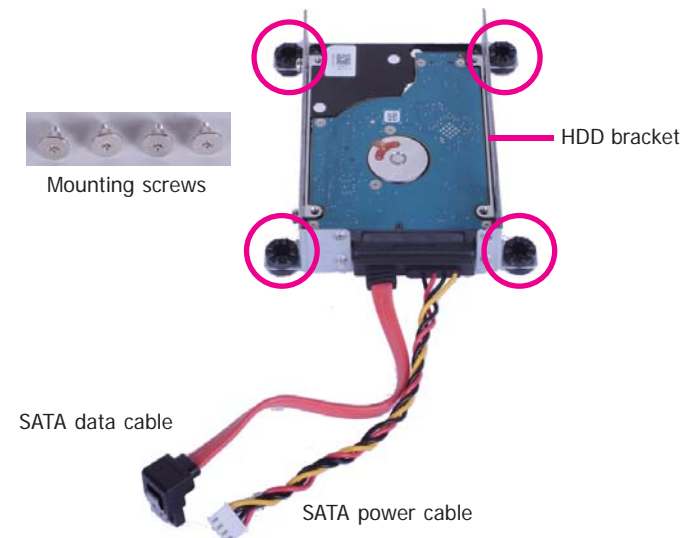



Mounting screw

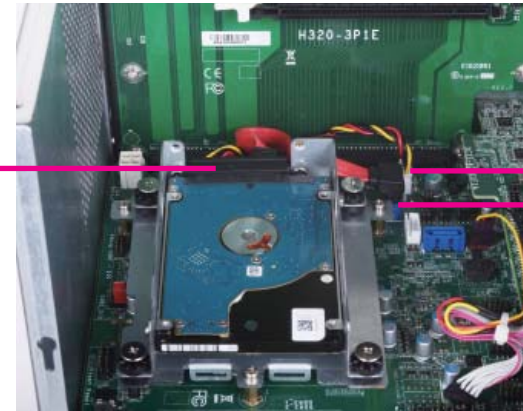

SATA power/data connector

SATA power connector  
SATA data connector

- 5. Connect the SATA power cable and SATA data cable to the SATA power connector and the SATA data connector on the system board respectively.

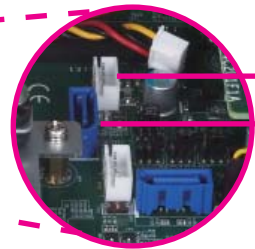

SATA power connector  
SATA data connector

## Installing the Mini PCIe and/or mSATA Card

1. The Mini PCIe slot is located on the system board.

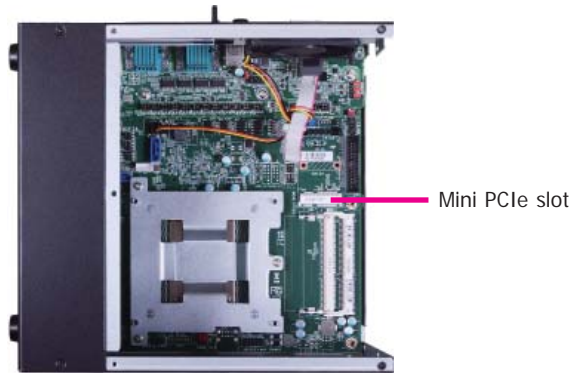

2. The system board is equipped with 1 Mini PCIe slot. The Mini PCIe slot supports a half length or a full length Mini PCIe card. Note the key on the slot. The key ensures the Mini PCIe card can be plugged into the slot in one direction only.

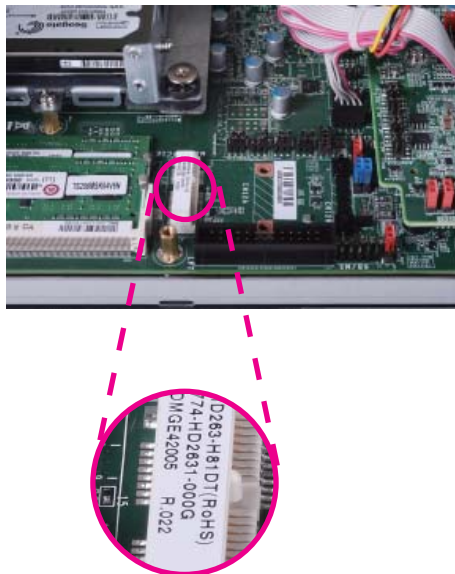

3. Grasping the Mini PCIe card by its edges, align the card into the slot at an approximately 30 degrees angle. Apply firm even pressure to each end of the card until it slips down into the slot. The contact fingers on the edge of the card will almost completely disappear inside the slot.



4. Push the Mini PCIe card down until the clips at each end of the latch lock into the position. You will hear a distinctive "click", indicating the card is correctly locked into the position.

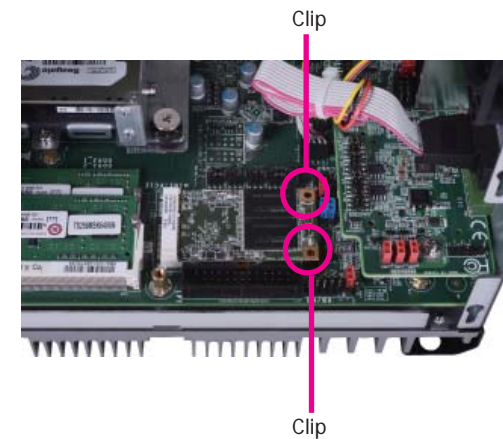

## Installing the PCI and PCIe Expansion Cards



### Important:

When inserting expansion cards into the system unit, please select a standard card within 190mm (as the following pictures show) in order to fit expansion slots.

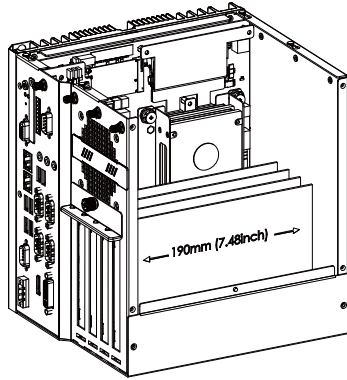

Mechanical Drawing for Expansion Cards (EC541-HD)

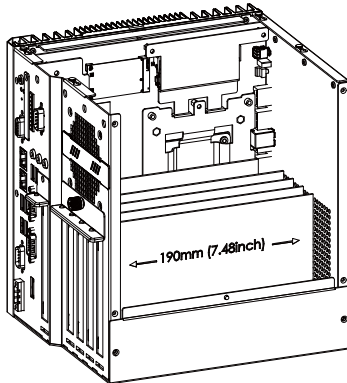

Mechanical Drawing for Expansion Cards (EC55x-HD/DL)

1. PCI slots, PCIe x16 slots and the PCIe x4 slot on riser cards are used to install expansion cards. To install expansion cards, you need to remove brackets from the chassis first.

### EC541-HD

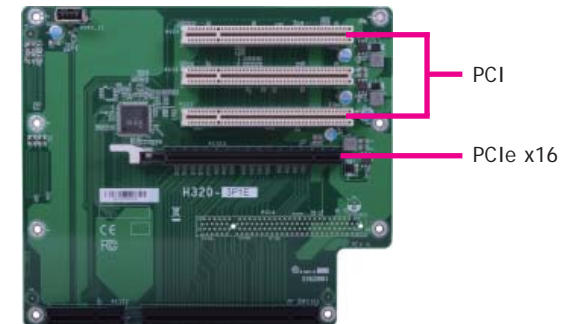
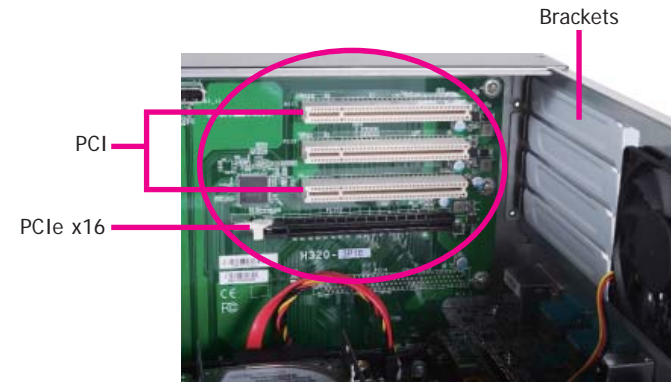

H320-3P1E for EC541-HD

EC550-HD

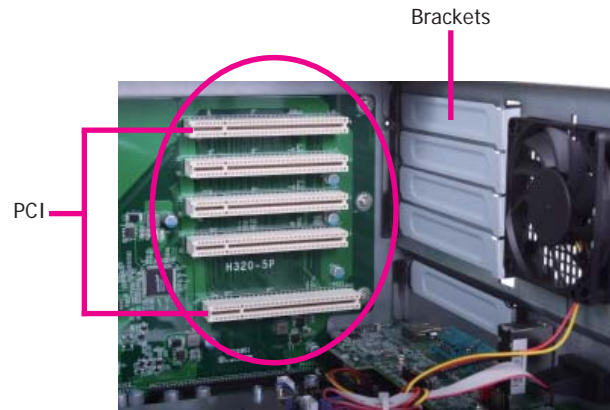

EC551-HD

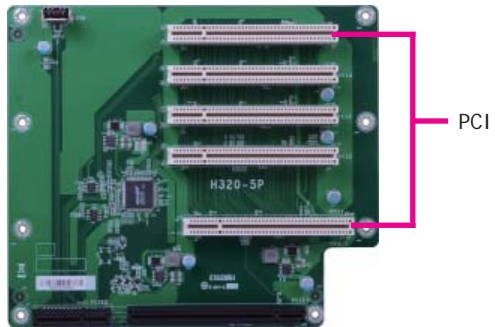
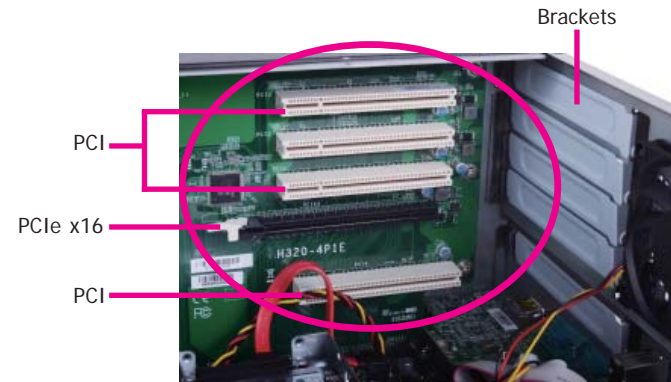

H320-5P for EC550-HD

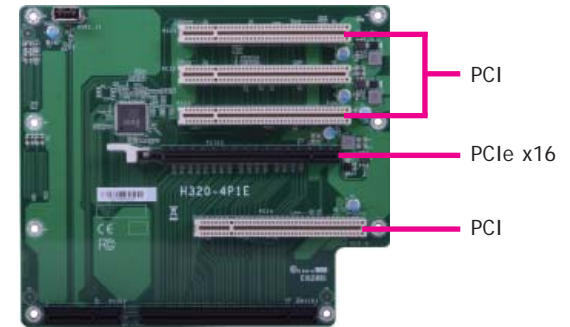

H320-4P1E for EC551-HD

EC553-DL

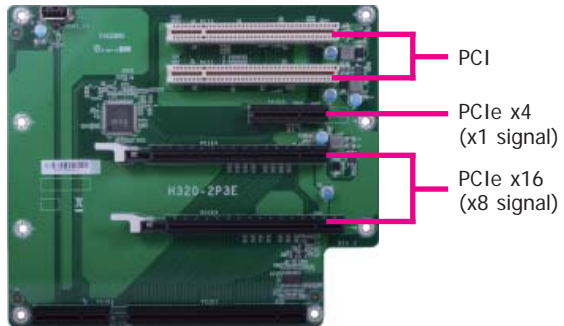
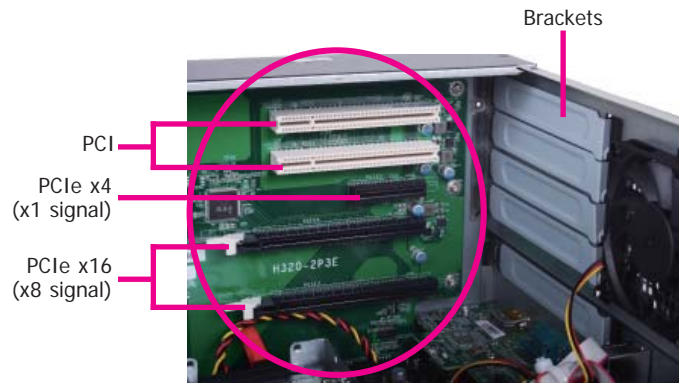

H320-2P3E for EC553-DL

2. Before removing brackets, you have to remove the mounting screws on the chassis.

EC541-HD

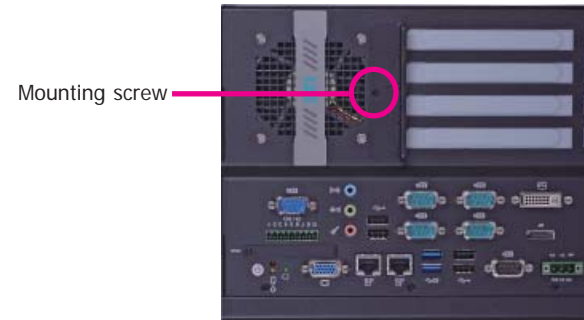

EC550-HD/EC551-HD/EC553-DL

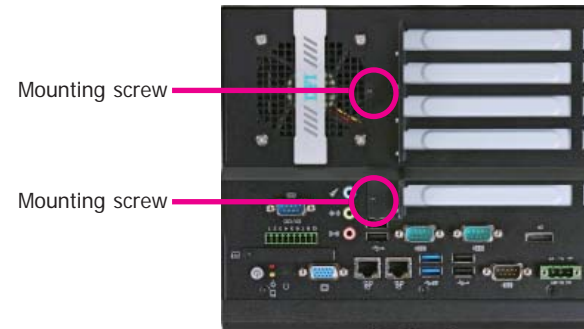

4. Insert one expansion card with a bracket into PCIe slots or PCI slots respectively that are on the riser card and secure the bracket in place.

## EC541-HD

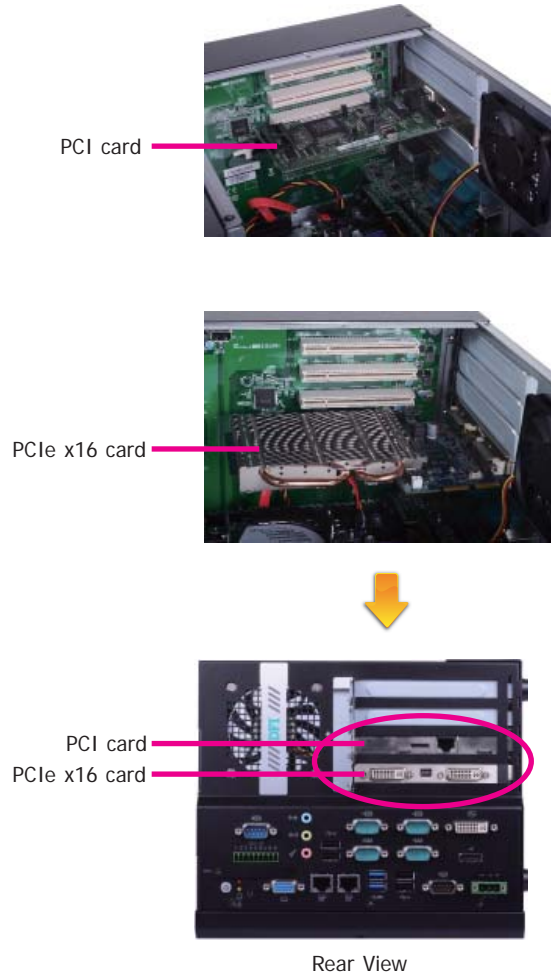

## EC550-HD

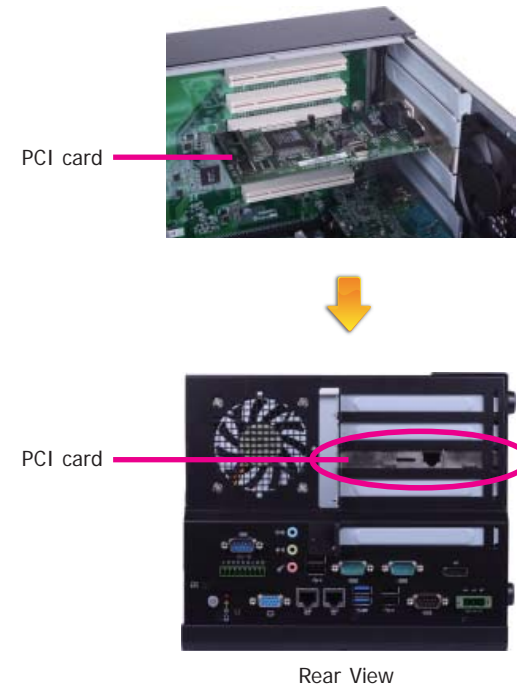

EC551-HD

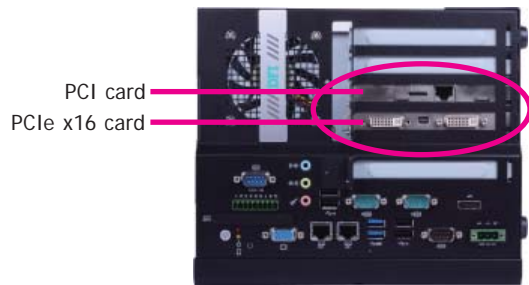
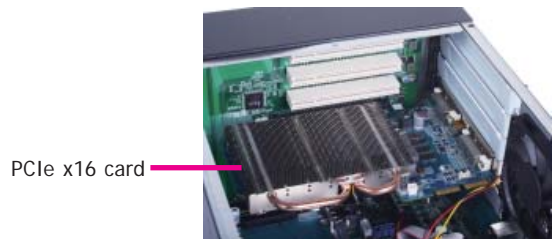
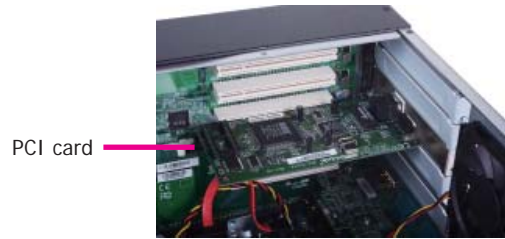

Rear View

EC553-DL

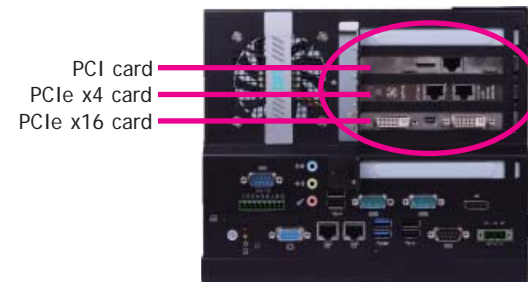
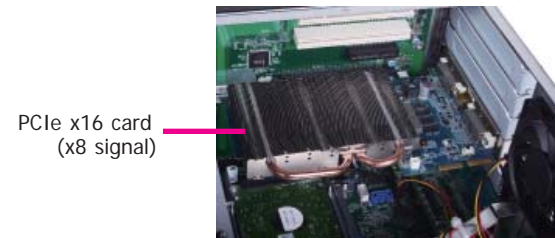
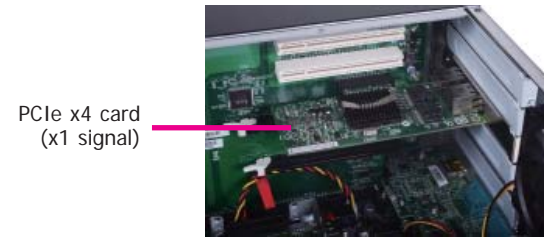

Rear View



## Installing the CPU

1. Make sure the system and all other peripheral devices connected to it have been powered-off.
2. Disconnect all power cords and cables.
3. Before installing the Intel CPU, remove the 8 mounting screws on the top side of the system unit and then put them in a safe place for later use.

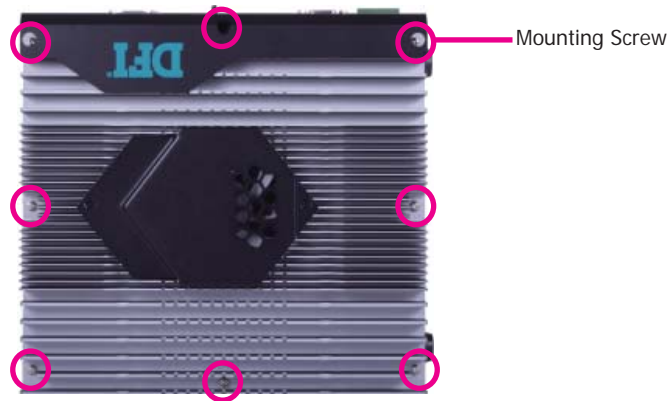

4. The system board is equipped with a surface mount LGA 1150 socket. This socket is exclusively designed for installing a LGA 1150 packaged Intel CPU.



### Important:

1. Before you proceed, make sure (1) the LGA 1150 socket comes with a protective cap, (2) the cap is not damaged and (3) the socket's contact pins are not bent. If the cap is missing or the cap and/or contact pins are damaged, contact your dealer immediately.
2. Make sure to keep the protective cap. RMA requests will be accepted and processed only if the LGA 1150 socket comes with the protective cap.

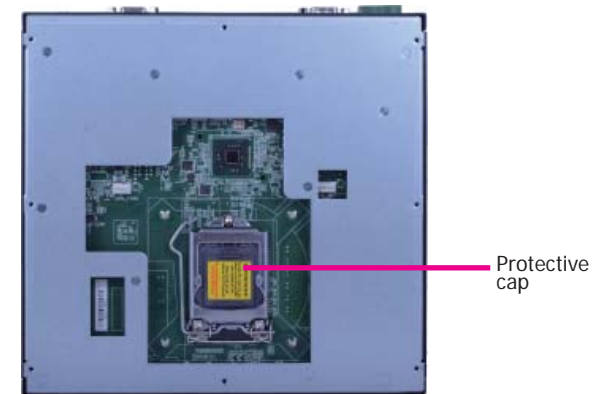

5. Unlock the socket by pushing the load lever down, moving it sideways until it is released from the retention tab; then lift the load lever up.

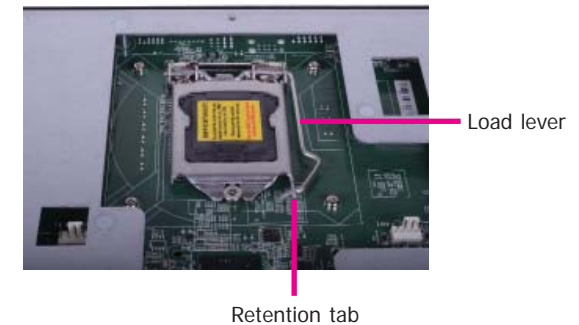

- Lifting the load lever will at the same time lift the load plate and lift the load lever up to the angle as the photo shown below.

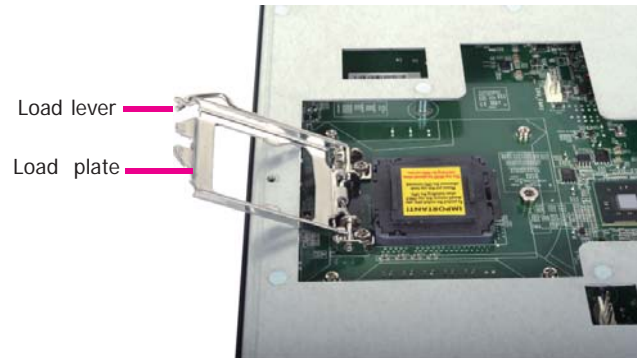

- Remove the protective cap from the CPU socket. The cap is used to protect the CPU socket against dust and harmful particles. Remove the protective cap only when you are about to install the CPU.

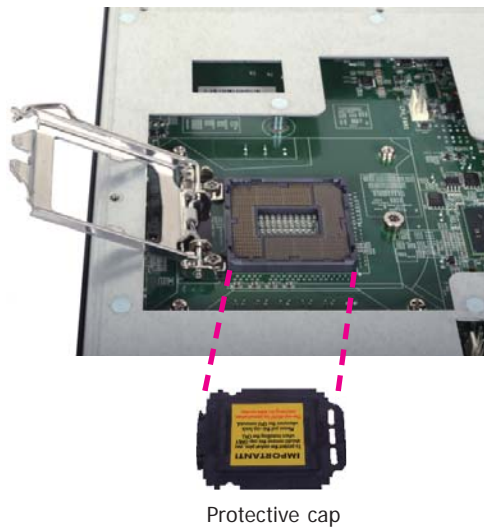

- Insert the CPU into the socket. The gold triangular mark on the CPU must align with the corner of the CPU socket as the photo shown below.

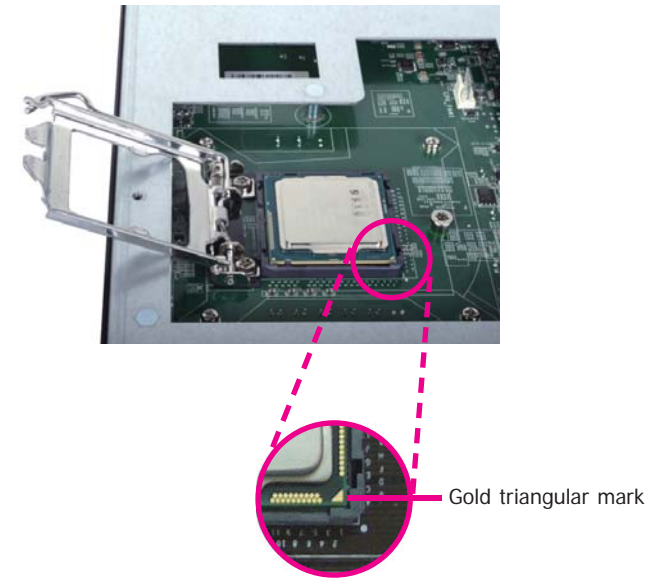

The CPU's notch will at the same time fit into the socket's alignment key.

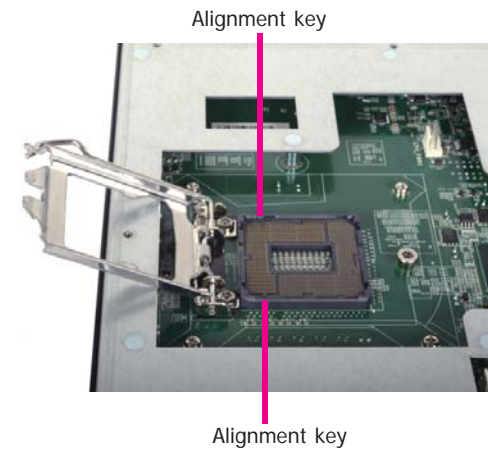



**Important:**

The CPU will fit in only one orientation and can easily be inserted without exerting any force.

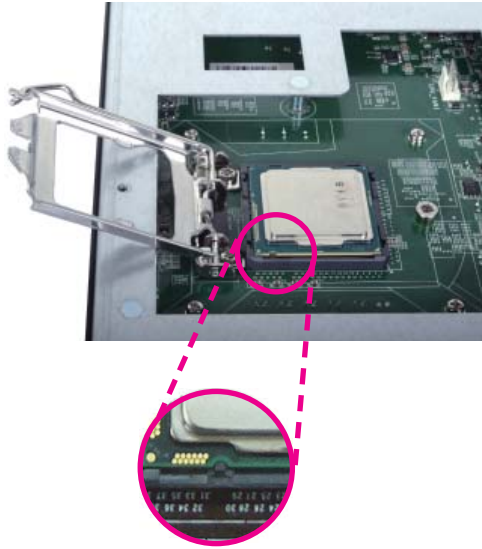

9. Close the load plate then push the load lever down.

While closing the load plate, make sure the front edge of the load plate slides under the retention knob.



10. Hook the load lever under the retention tab.

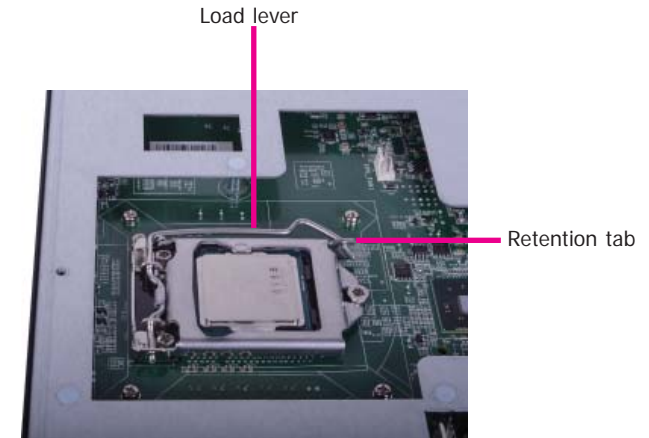

## Chapter 4 - Jumper Settings

### Jumper Settings - System Board

#### Clear CMOS Data

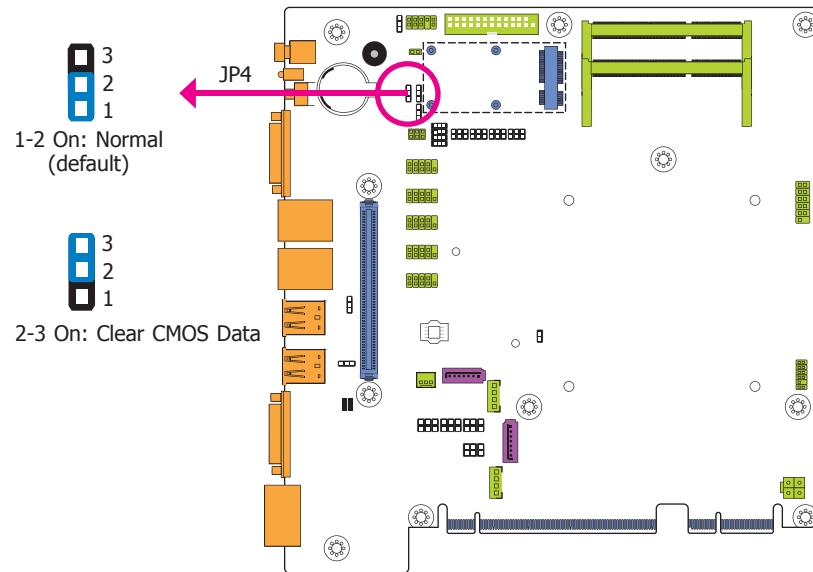

If you encounter the following,

- CMOS data becomes corrupted.
- You forgot the supervisor or user password.

you can reconfigure the system with the default values stored in the ROM BIOS.

To load the default values stored in the ROM BIOS, please follow the steps below.

- Power-off the system and unplug the power cord.
- Set JP4 pins 2 and 3 to On. Wait for a few seconds and set JP4 back to its default setting, pins 1 and 2 On.
- Now plug the power cord and power-on the system.

#### USB Power Select

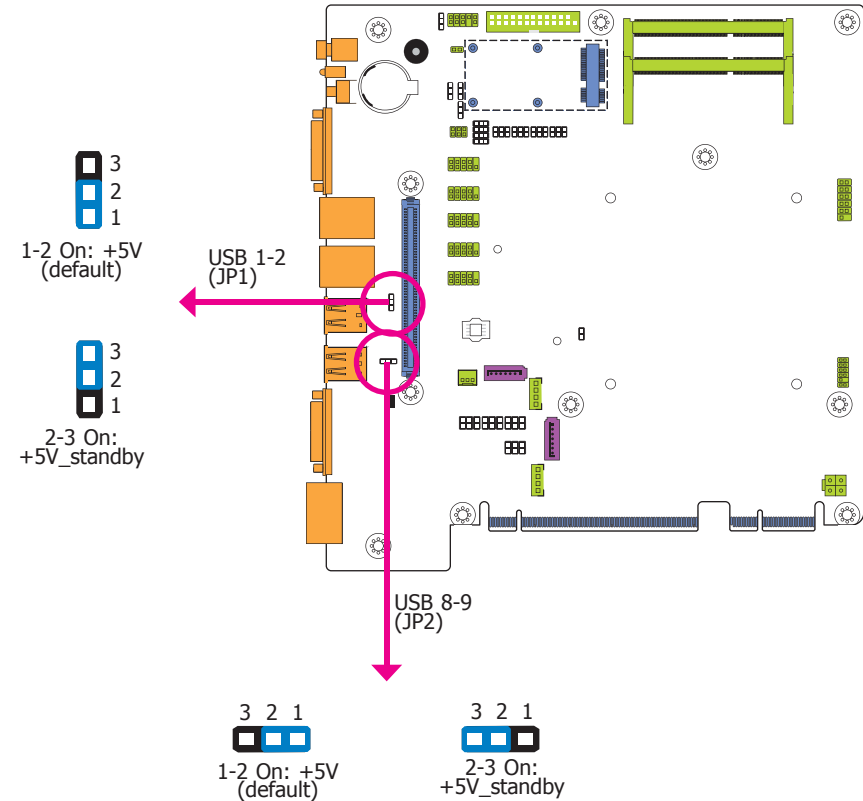

JP1 and JP2 are used to select the power of the USB ports. Selecting +5V\_standby will allow you to use a USB device to wake up the system.



#### Important:

If you are using the Wake-On-USB Keyboard/Mouse function for 2 USB ports, the +5V\_standby power source of your power supply must support  $\geq 1.5A$ . For 3 or more USB ports, the +5V\_standby power source of your power supply must support  $\geq 2A$ .

## Auto Power-on Select

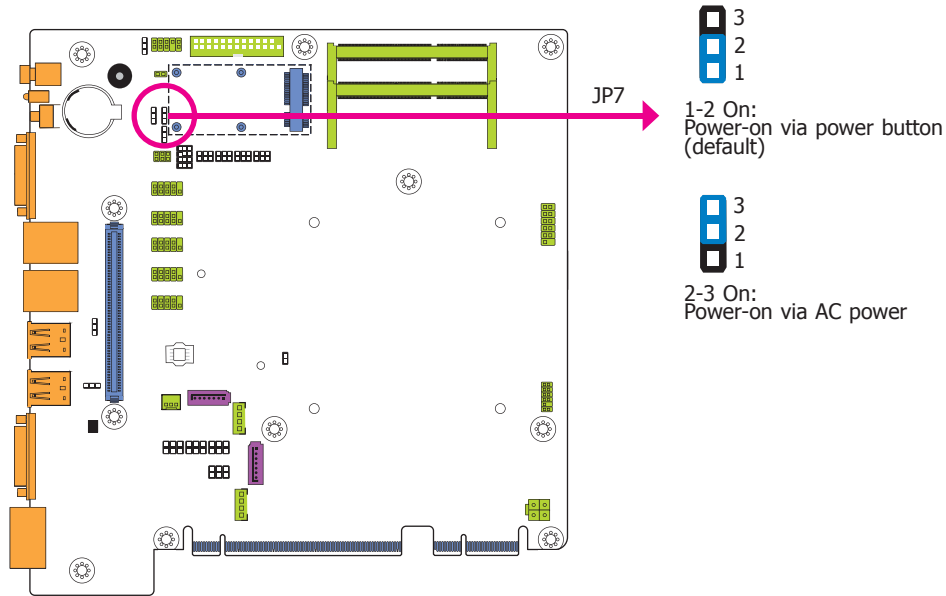

JP7 is used to select the method of powering on the system. If you want the system to power-on whenever AC power comes in, set JP7 pins 2 and 3 to On. If you want to use the power button, set pins 1 and 2 to On.

When using the JP7 "Power On" feature to power the system back on after a power failure occurs, the system may not power on if the power lost is resumed within 5 seconds (power flicker).

## PS/2 Keyboard/Mouse Power Select

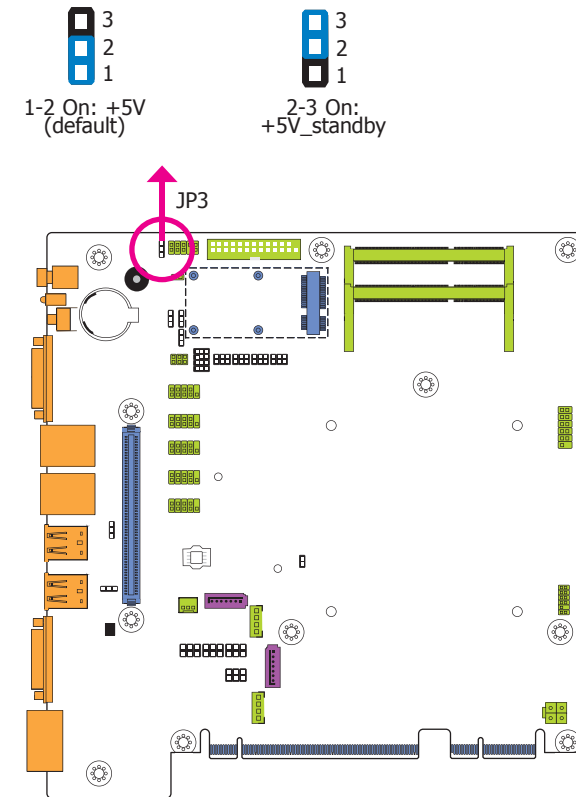

JP3 is used to select the power of the PS/2 keyboard/mouse port. Selecting +5V\_standby will allow you to use the PS/2 keyboard or PS/2 mouse to wake up the system.

**Important:**

The +5V\_standby power source of your power supply must support  $\geq 720\text{mA}$ .

COM 1/COM 2 RS232/422/485 Select

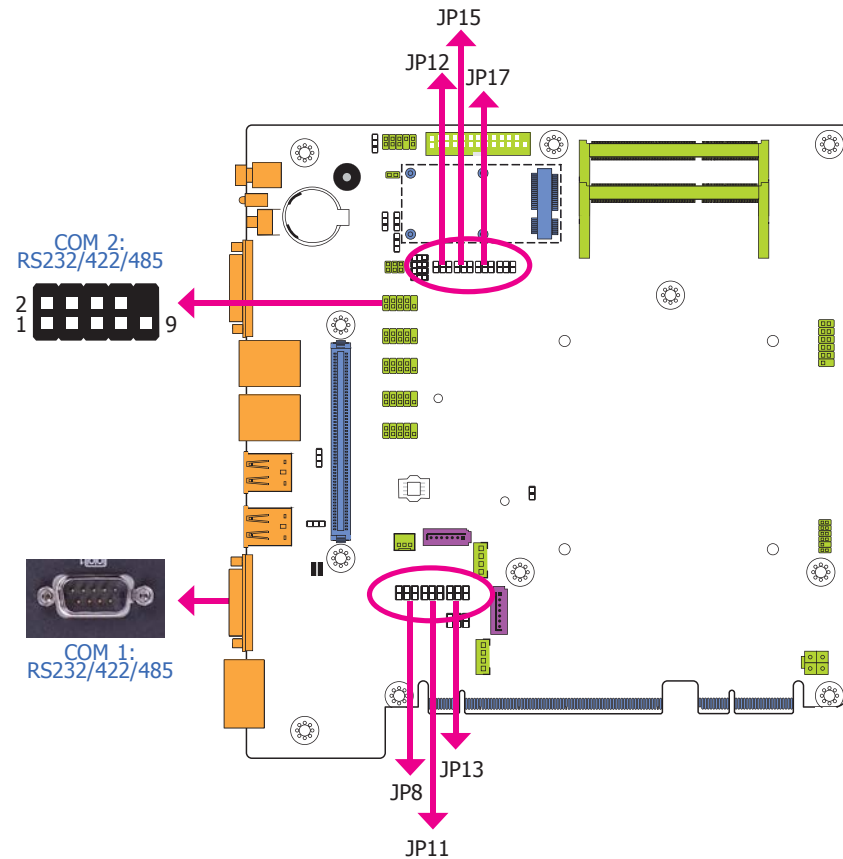

These jumpers allow you to configure the Serial COM ports to RS232, RS422 (Full Duplex) or RS485. JP8, JP11 and JP13 are used to configure the Serial COM port 1. JP12, JP15 and JP17 are used to configure the Serial COM port 2. The pin functions of Serial COM port 1 and COM port 2 will vary according to these jumpers' setting.

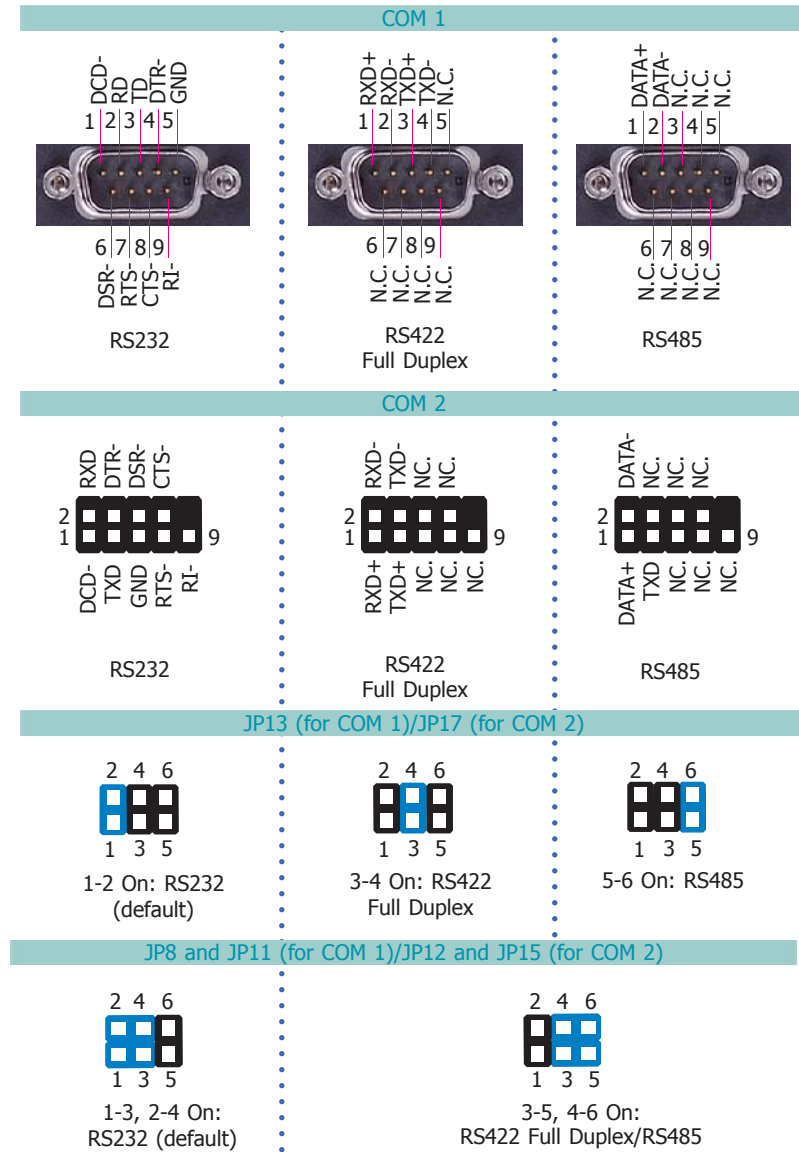

**Note:** When COM 1 RS232/422/485 is selected, JP8 and JP11 must be set in accordance to JP13. And when COM 2 RS232/422/485 is selected, JP12 and JP15 must be set in accordance to JP17.

### COM 1/COM 2 RS232/Power Select

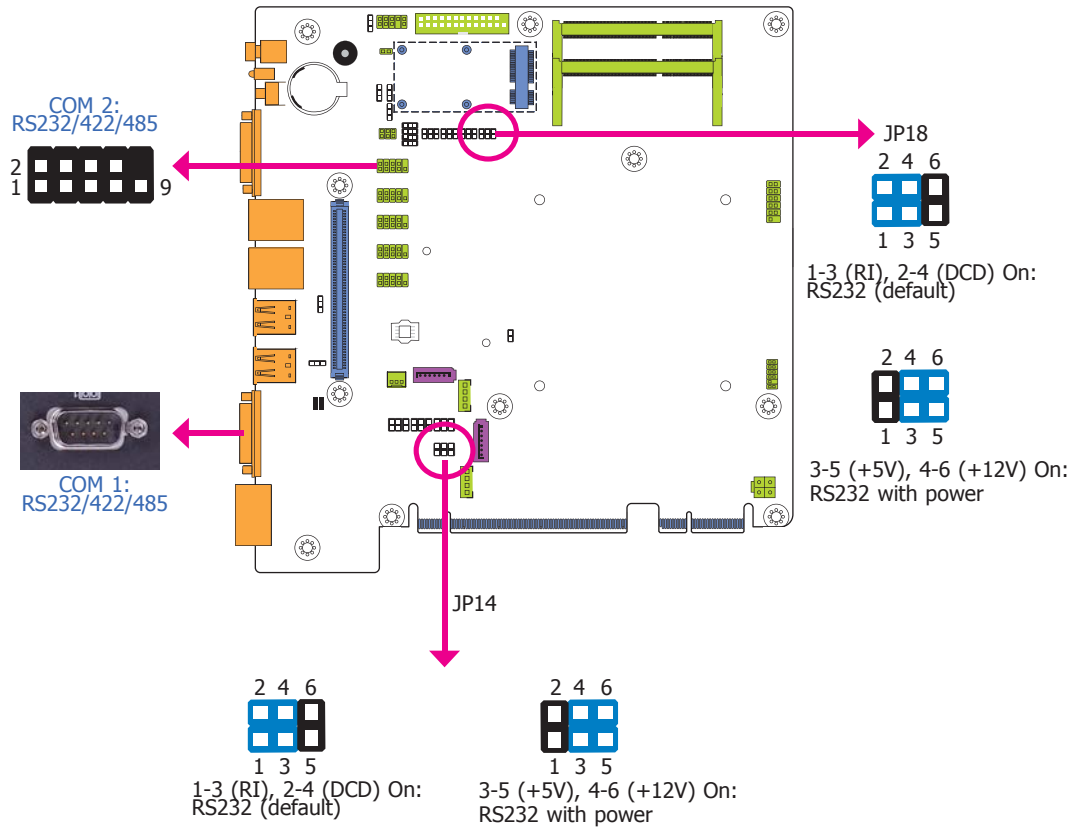

### Mini PCIe Signal Select

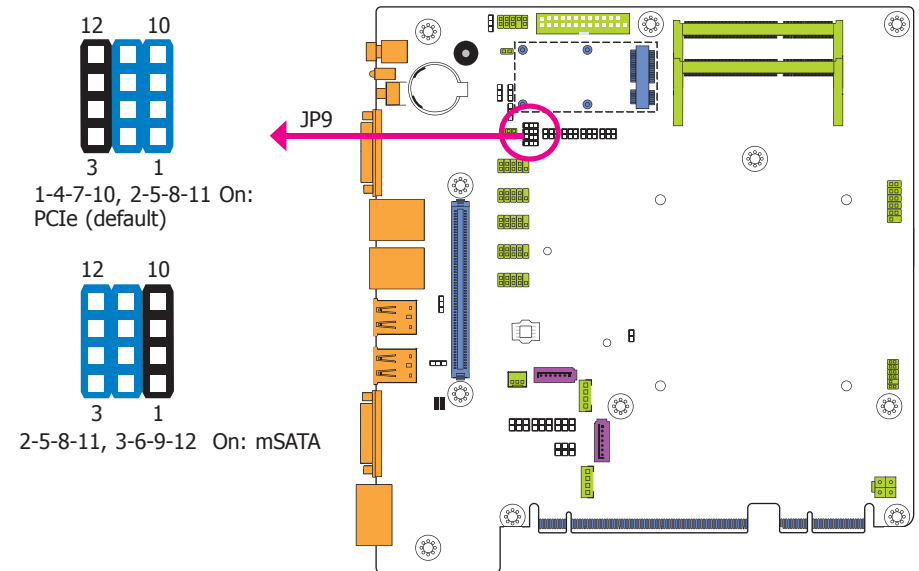

JP9 is used to select the Mini PCIe signal: PCIe or mSATA.

JP14 (for COM 1) and JP18 (for COM 2) are used to configure Serial COM ports to pure RS232 or RS232 with power. The pin functions of COM 1 and COM 2 will vary according to JP14's and JP18's setting respectively.

## Mini PCIe Power Select

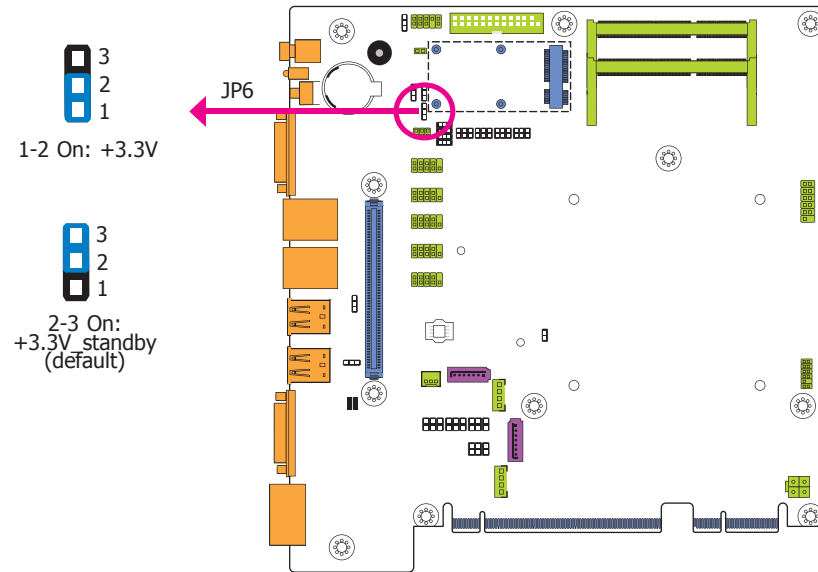

JP6 is used to select the power supplied with the Mini PCIe.

## Jumper Settings - I/O Board (for EC541-HD)

### USB Power Select

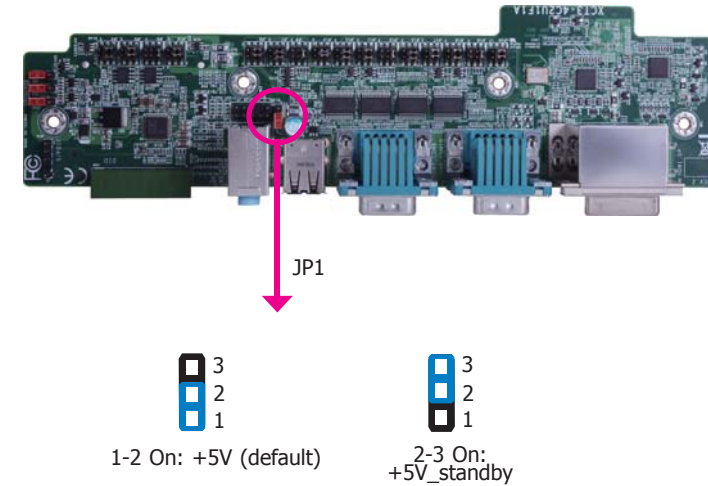

JP1 is used to select the power of the USB ports. Selecting +5V\_standby will allow you to use a USB device to wake up the system.



#### Important:

If you are using the Wake-On-USB Keyboard/Mouse function for 2 USB ports, the +5V\_standby power source of your power supply must support  $\geq 1.5A$ . For 3 or more USB ports, the +5V\_standby power source of your power supply must support  $\geq 2A$ .



## COM 7 to COM 10 RS232/422/485 Select

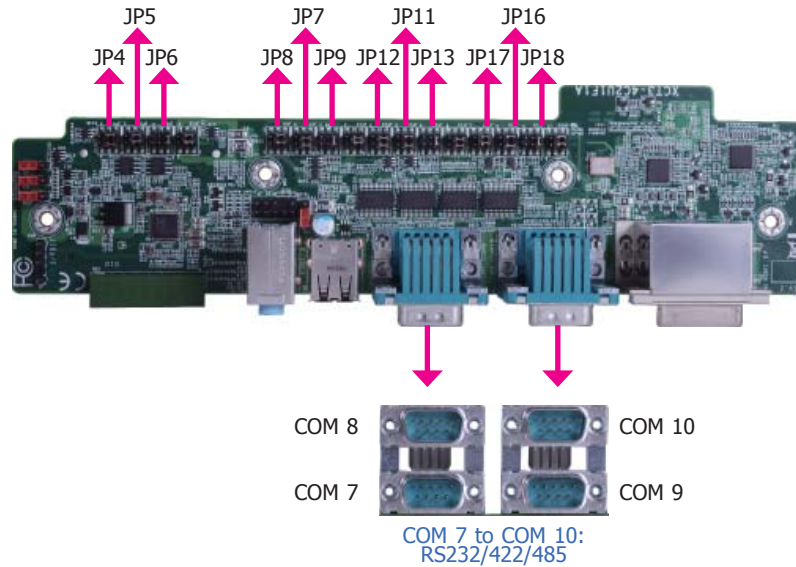

These jumpers allow you to configure Serial COM ports to RS232, RS422 (Full Duplex) or RS485. JP4, JP5 and JP6 are used to configure the Serial COM port 7. JP7, JP8 and JP9 are used to configure the Serial COM port 8. JP11, JP12 and JP13 are used to configure the Serial COM port 9. JP16, JP17 and JP18 are used to configure the Serial COM port 10. The pin functions of the Serial COM port 7 to 10 will vary according to these jumpers' setting.

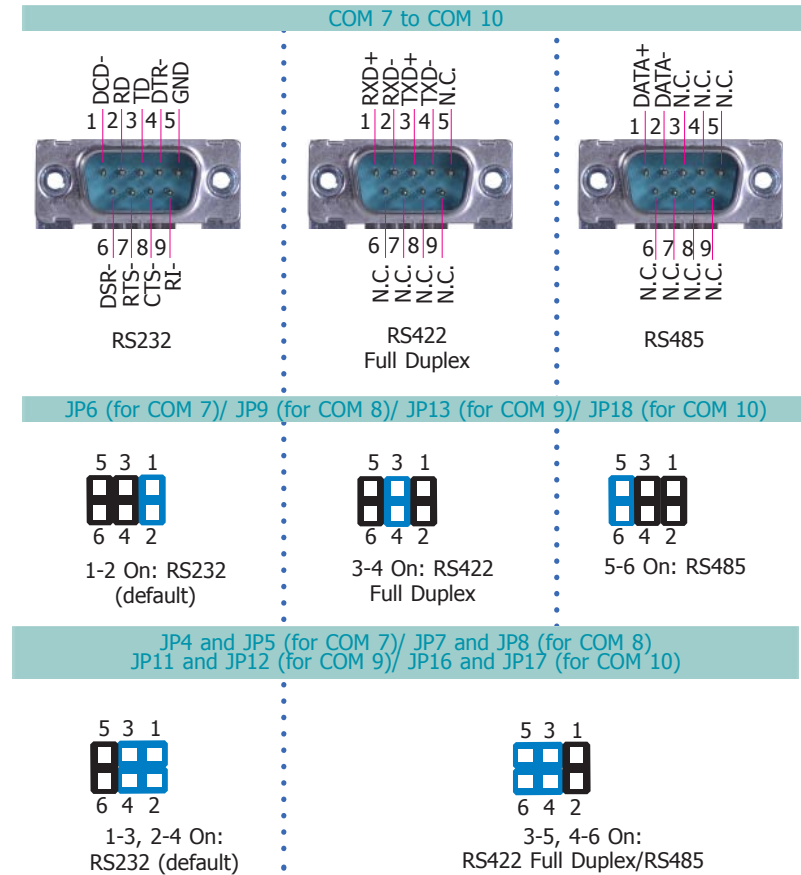

### Note:

1. When COM 7 RS232/422/485 is selected, JP4 and JP5 must be set in accordance to JP6.
2. When COM 8 RS232/422/485 is selected, JP7 and JP8 must be set in accordance to JP9.
3. When COM 9 RS232/422/485 is selected, JP11 and JP12 must be set in accordance to JP13.
4. When COM 10 RS232/422/485 is selected, JP16 and JP17 must be set in accordance to JP18.

### COM 7 to COM 10 RS232/Power Select

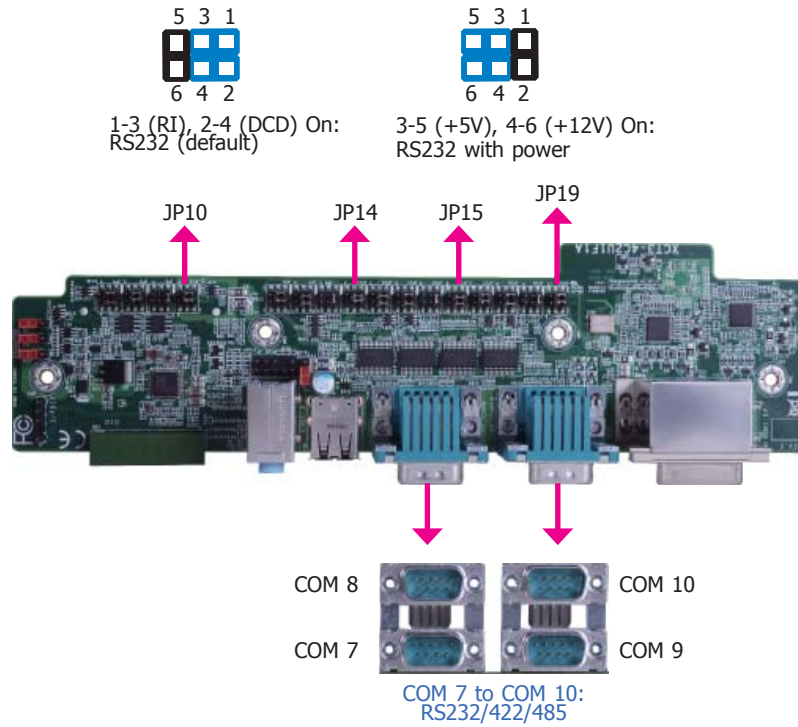

JP10 (for COM 7), JP14 (for COM 8), JP15 (for COM 9) and JP19 (for COM 10) are used to configure Serial COM ports to pure RS232 or RS232 with power. The pin functions of COM 7 to COM 10 will vary according to these jumpers' settings respectively.

### Digital I/O Power Select

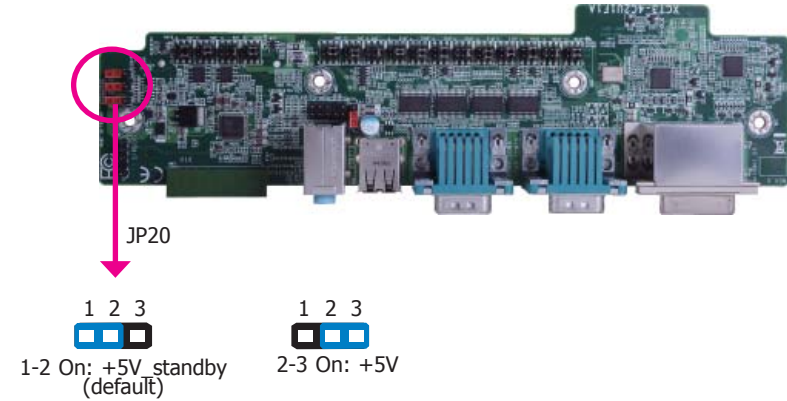

JP20 is used to select the power of DIO (Digital I/O) signal.

## Digital I/O Output State

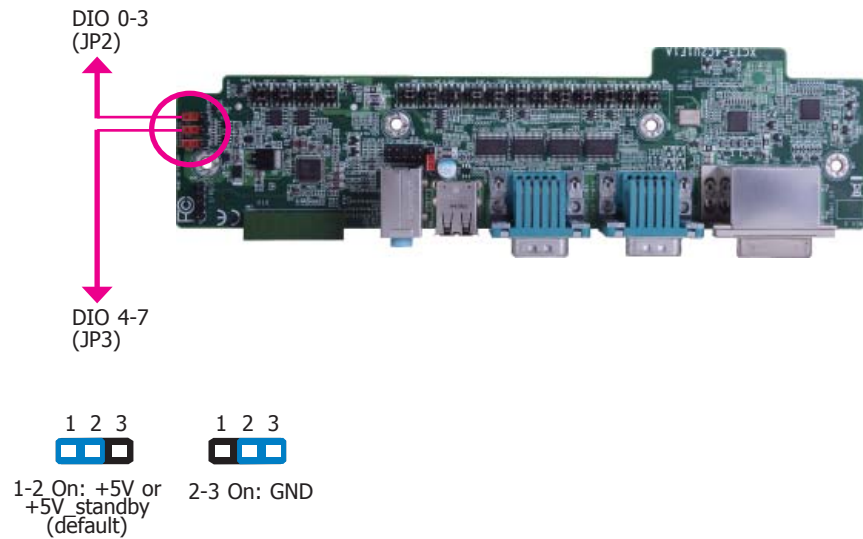

Based on the power level of DIO (Digital I/O) selected on JP20, JP2 (DIO pin 0-3) and JP3 (DIO pin 4-7) are used to select the state of DIO output: pull high or pull low. When selecting pull high, the power selection will be the same as JP20's setting.

Jumper Settings - I/O Board  
(for EC550-HD/EC551-HD/EC553-DL)

## USB Power Select

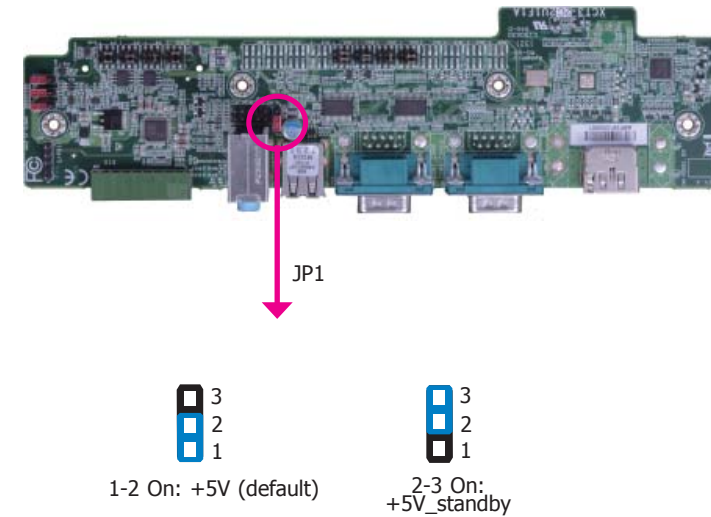

JP1 is used to select the power of the USB ports. Selecting +5V\_standby will allow you to use a USB device to wake up the system.

**Important:**

If you are using the Wake-On-USB Keyboard/Mouse function for 2 USB ports, the +5V\_standby power source of your power supply must support  $\geq 1.5A$ . For 3 or more USB ports, the +5V\_standby power source of your power supply must support  $\geq 2A$ .

COM 7/COM 9 RS232/422/485 Select

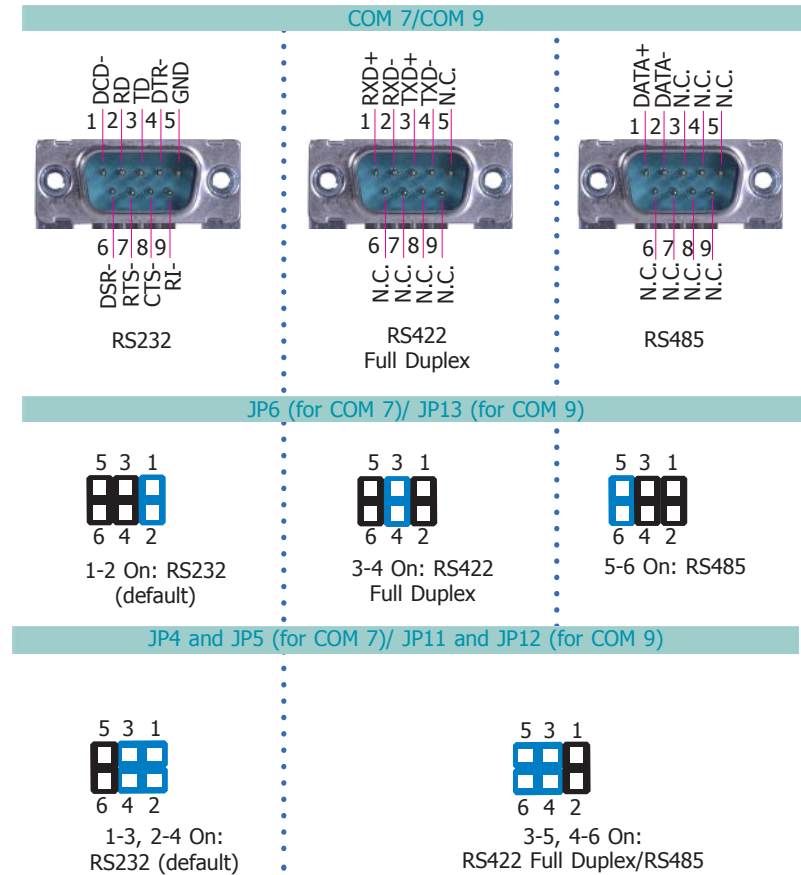
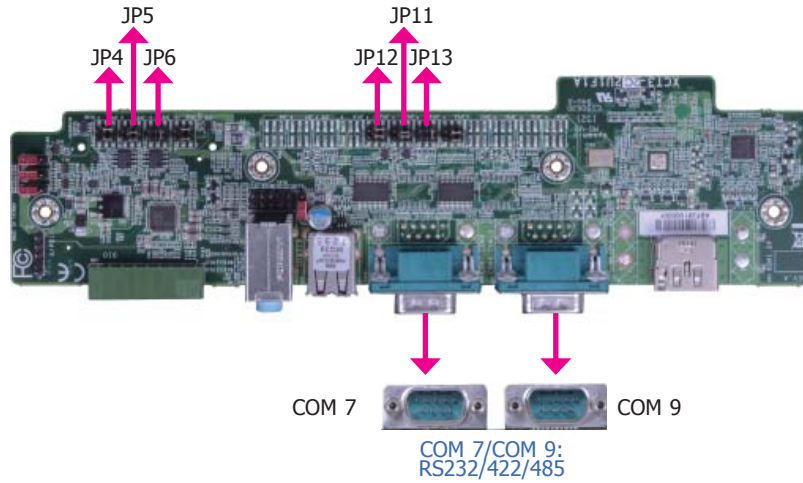

These jumpers allow you to configure Serial COM ports to RS232, RS422 (Full Duplex) or RS485. JP4, JP5 and JP6 are used to configure the Serial COM port 7. JP11, JP12 and JP13 are used to configure the Serial COM port 9. The pin functions of the Serial COM port 7 and 9 will vary according to these jumpers' setting.



**Note:**

1. When COM 7 RS232/422/485 is selected, JP4 and JP5 must be set in accordance to JP6.
2. When COM 9 RS232/422/485 is selected, JP11 and JP12 must be set in accordance to JP13.

### COM 7/COM 9 RS232/Power Select

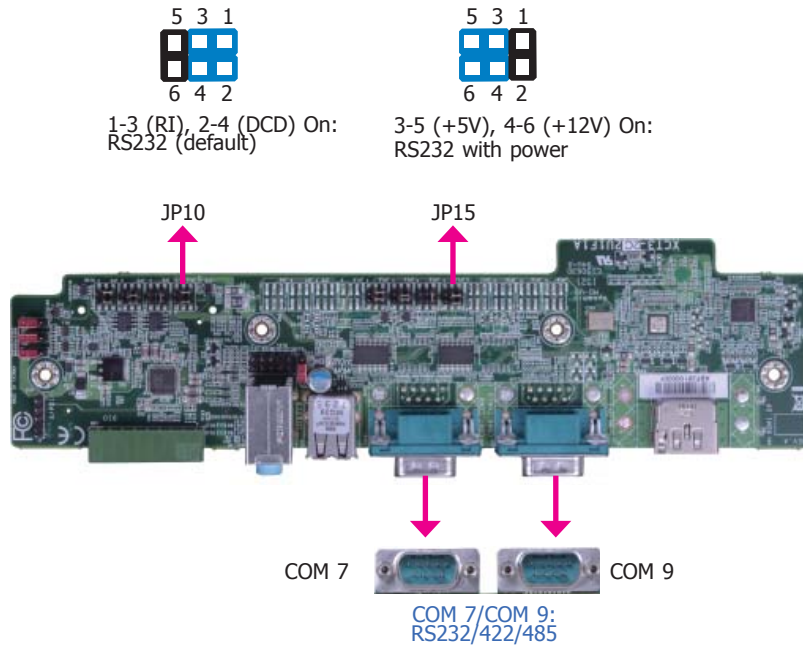

JP10 (for COM 7) and JP15 (for COM 9) are used to configure Serial COM ports to pure RS232 or RS232 with power. The pin functions of COM 7 and COM 9 will vary according to these jumpers' settings respectively.

### Digital I/O Power Select

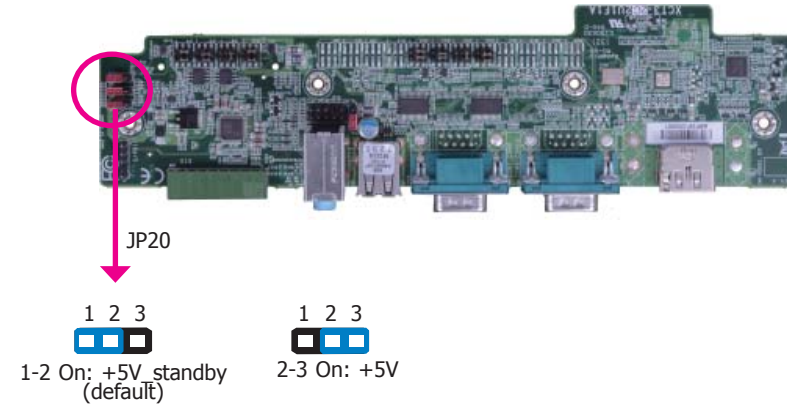

JP20 is used to select the power of DIO (Digital I/O) signal.

## Digital I/O Output State

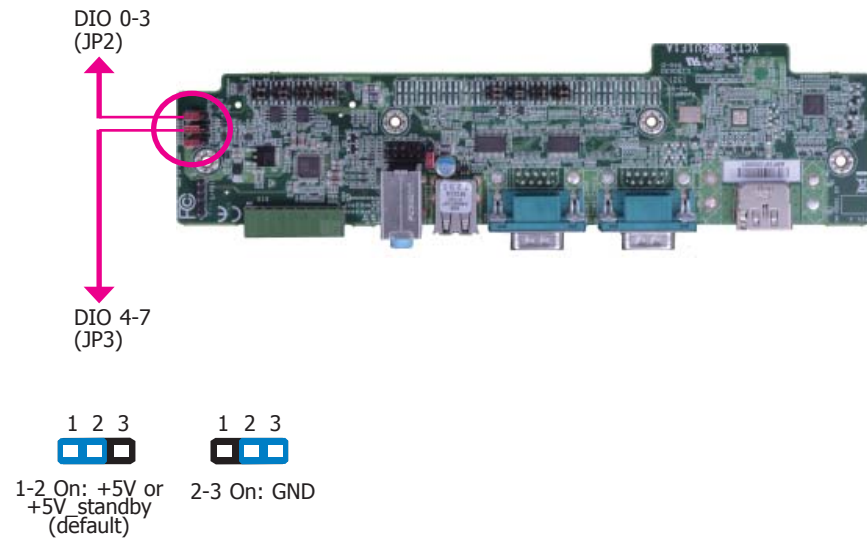

Based on the power level of DIO (Digital I/O) selected on JP20, JP2 (DIO pin 0-3) and JP3 (DIO pin 4-7) are used to select the state of DIO output: pull high or pull low. When selecting pull high, the power selection will be the same as JP20's setting.

## Chapter 5 - Ports and Connectors

### Front Panel I/O Ports

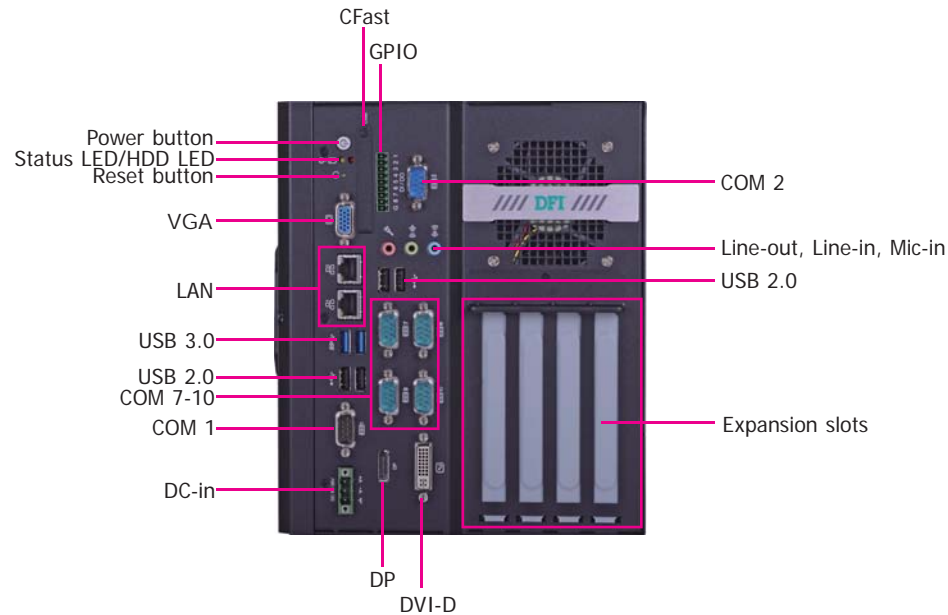

The front panel I/O ports consist of the followings:

#### EC541-HD

- 1 Power button with LED
- 1 Reset button
- 1 Status LED
- 1 HDD LED
- 1 VGA port
- 2 RJ45 LAN ports
- 4 Type A USB 2.0 ports
- 2 Type A USB 3.0 ports
- 6 DB-9 RS232/422/485 serial ports (with power)
- 1 9~36V DC-in 3-pole terminal block
- 1 8-bit GPIO 9-pole terminal block
- Mic-in, Line-in, Line-out
- 1 DVI-D port
- 1 DP port

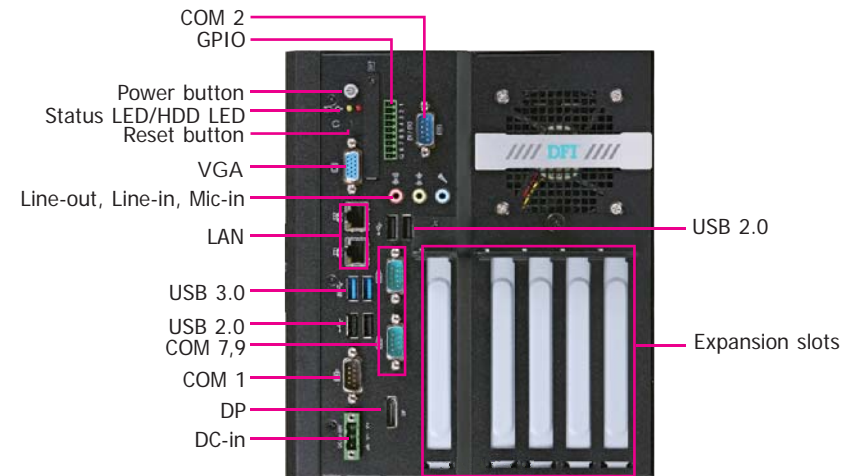

The front panel I/O ports consist of the followings:

#### EC550-HD/EC551-HD/EC553-DL

- 1 Power button with LED
- 1 Reset button
- 1 Status LED
- 1 HDD LED
- 1 VGA port
- 1 DP port
- 2 RJ45 LAN ports
- 4 Type A USB 2.0 ports
- 2 Type A USB 3.0 ports
- 4 DB-9 RS232/422/485 Serial COM ports (with power)
- 1 9~36V DC-in 3-pole terminal block
- 1 8-bit GPIO 9-pole terminal block
- Mic-in, Line-in, Line-out

## VGA Port

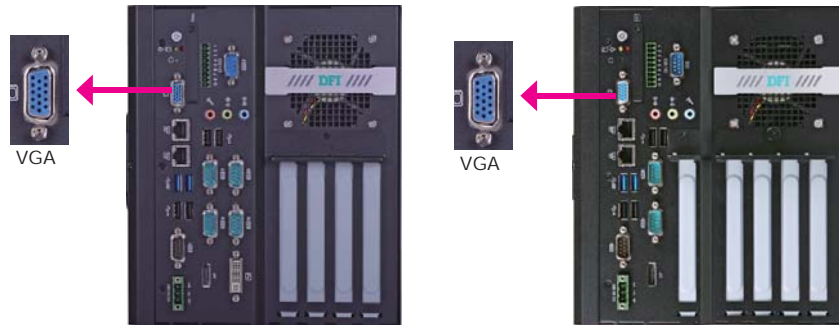

The VGA port is used for connecting a VGA monitor. Connect the monitor's 15-pin D-shell cable connector to the VGA port. After you plug the monitor's cable connector into the VGA port, gently tighten the cable screws to hold the connector in place.

### BIOS Setting

Configure the display device in the Chipset menu ("System Agent Configuration" submenu) of the BIOS. Refer to chapter 7 for more information.

### Driver Installation

Install the graphics driver. Refer to chapter 8 for more information.

## RJ45 LAN Ports

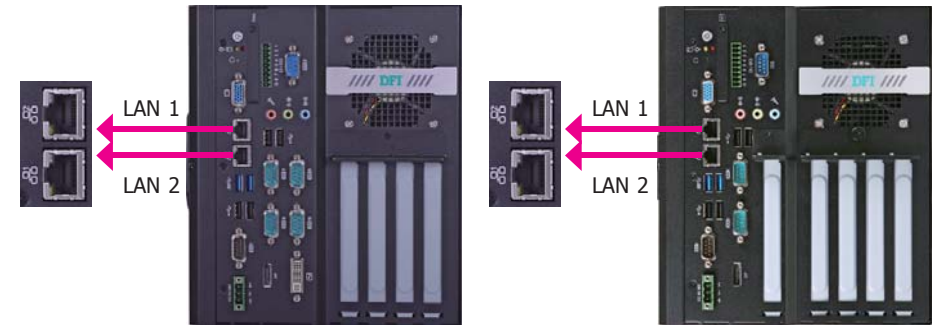

### Features

- Intel® I210 PCI Express Gigabit Ethernet Controller
- Intel® I217 Gigabit Ethernet Phy

The LAN ports allow the system board to connect to a local area network by means of a network hub.

### BIOS Setting

Configure the onboard LAN in the Chipset menu ("PCH-IO Configuration" submenu) of the BIOS. Refer to chapter 7 for more information.

### Driver Installation

Install the LAN drivers. Refer to chapter 8 for more information.



## USB Ports

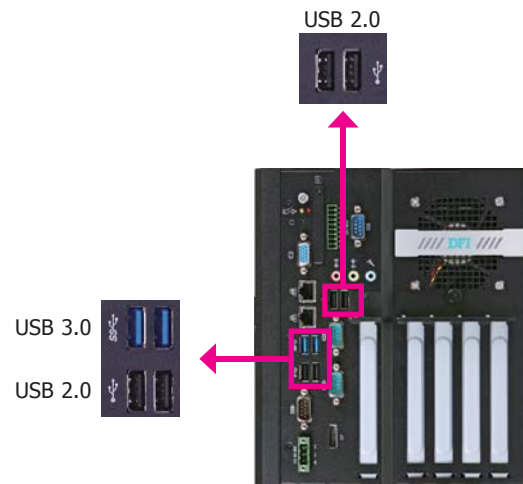
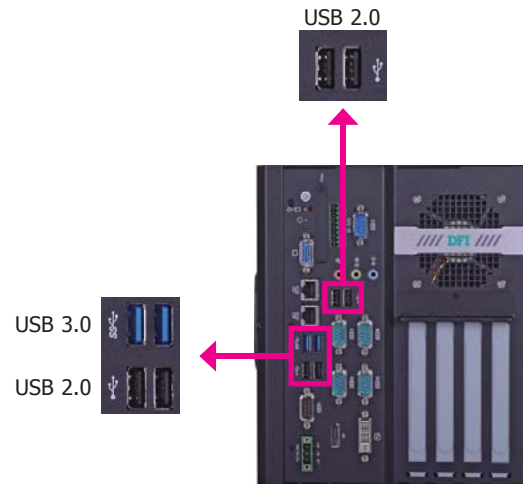

The USB device allows data exchange between your computer and a wide range of simultaneously accessible external Plug and Play peripherals. The system board is equipped with 2 USB 3.0 ports and 4 USB 2.0 ports.

- **BIOS Setting**

Configure the onboard USB in the Advanced menu ("USB Configuration" submenu) of the BIOS. Refer to chapter 7 for more information.

- **Wake-On-USB Keyboard/Mouse**

The Wake-On-USB Keyboard/Mouse function allows you to use a USB keyboard or USB mouse to wake up a system from the S3 (STR - Suspend To RAM) state. To use this function:

- **Jumper Setting**

JP1 and JP2 must be set to "2-3 On: +5V\_standby". Refer to "USB Power Select" in chapter 4 for more information.



**Important:**

If you are using the Wake-On-USB Keyboard/Mouse function for 2 USB ports, the +5V\_standby power source of your power supply must support  $\geq 1.5A$ . For 3 or more USB ports, the +5V\_standby power source of your power supply must support  $\geq 2A$ .

## COM (Serial) Ports

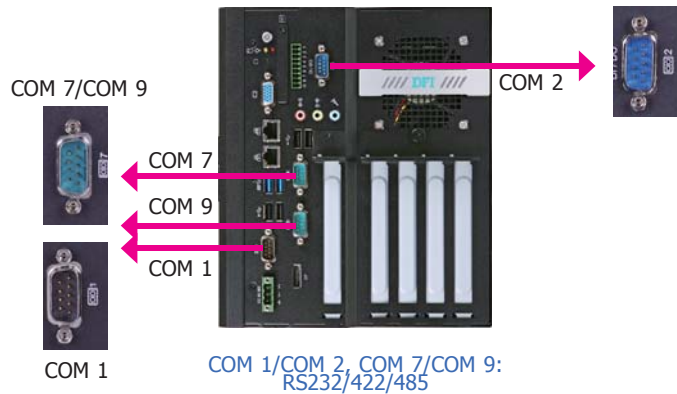
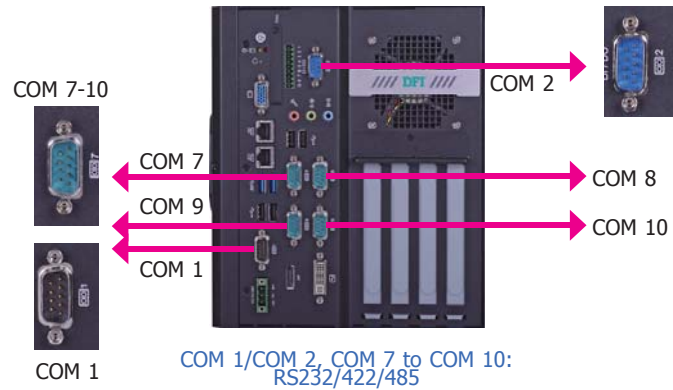

The serial ports are asynchronous communication ports with 16C550A-compatible UARTs that can be used with modems, serial printers, remote display terminals, and other serial devices.

### Connecting External Serial Ports

Your COM port may come mounted on a card-edge bracket. Install the card-edge bracket to an available slot at the rear of the system chassis then insert the serial port cable to the COM connector. Make sure the colored stripe on the ribbon cable is aligned with pin 1 of the COM connector.

- **BIOS Setting**

Configure the serial ports in the Advanced menu ("Super IO Configuration" submenu) of the BIOS. Refer to chapter 7 for more information.

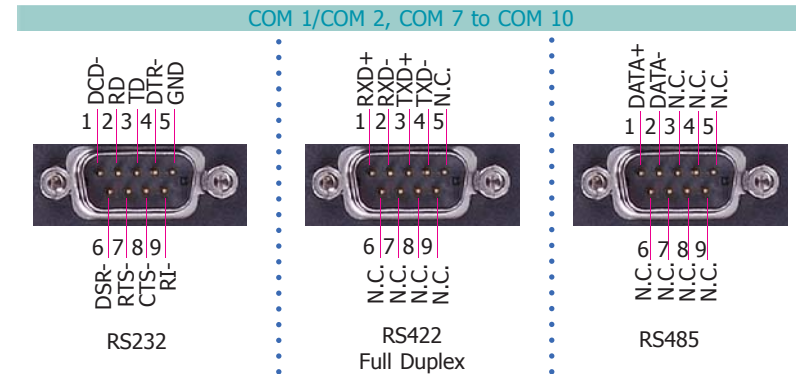

DC-in

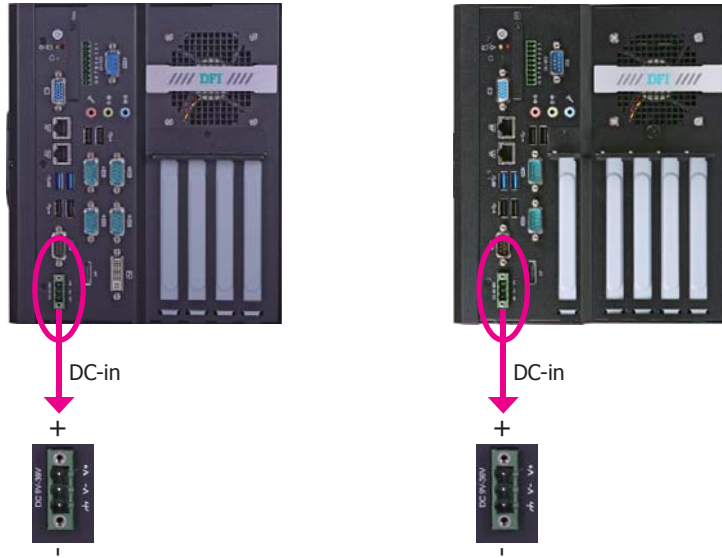

This jack provides maximum of 120W power and is considered a low power solution. Connect a DC power cord to this jack. Using a voltage higher than the recommended one may fail to boot the system or cause damage to the system board.

8-bit GPIO

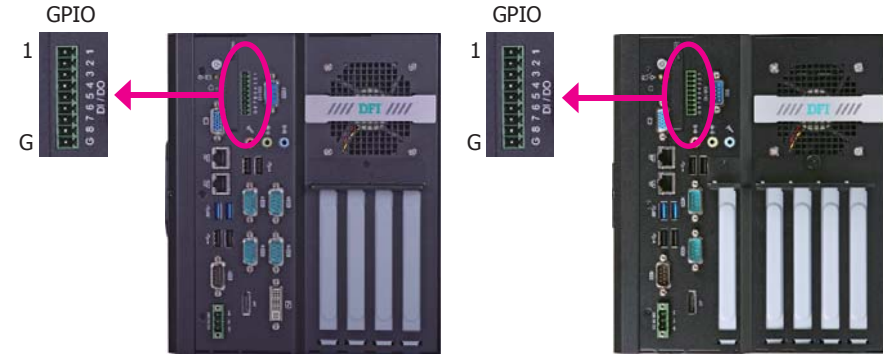

The Digital I/O connector provides powering-on function to an external device that is connected to this connector.

Pins	Digital Output/Input Pin Assignment
1	DIO1
2	DIO2
3	DIO3
4	DIO4
5	DIO5
6	DIO6
7	DIO7
8	DIO8
G	GND

## Audio jacks

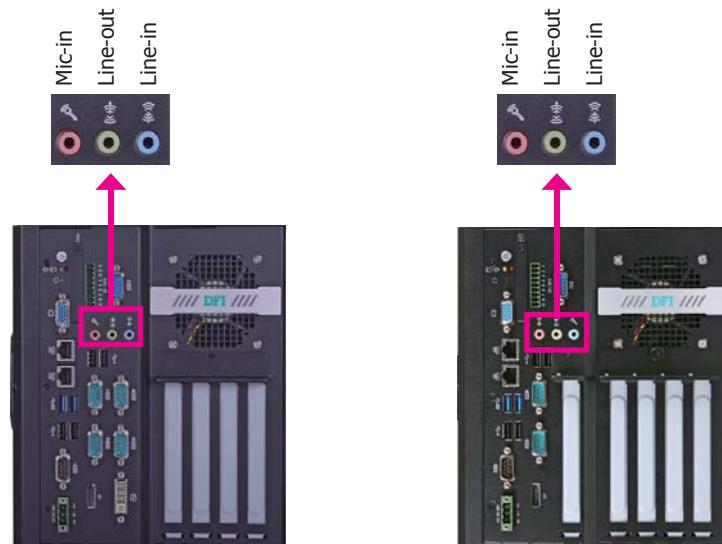

### Rear Audio

The system board is equipped with 3 audio jacks. A jack is a one-hole connecting interface for inserting a plug.

- Line-in/Surround Jack (Light Blue)  
This jack is used to connect any audio devices such as Hi-fi set, CD player, tape player, AM/FM radio tuner, synthesizer, etc.
- Line-out Jack (Lime)  
This jack is used to connect a headphone or external speakers.
- Mic-in/Center+Subwoofer Jack (Pink)  
This jack is used to connect an external microphone.

### Driver Installation

Install the audio driver. Refer to the chapter 8 for more information.

## DVI-D Port (For EC541-HD)

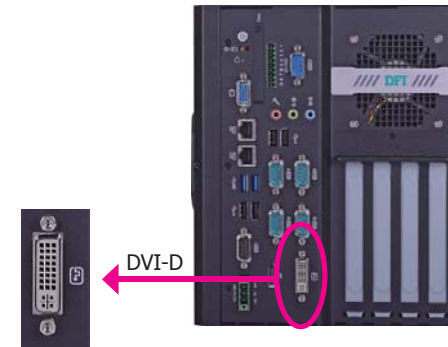

The DVI-D port is used to connect an LCD monitor. Connect the display device's cable connector to the DVI-D port. After plugging the cable connector into the port, gently tighten the cable screws to hold the connector in place.

## DP Port

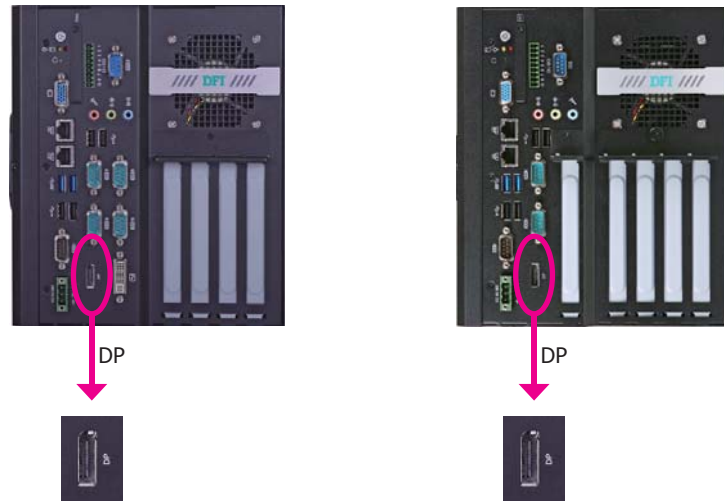

### DP Port

The DP port is a digital display interface used to connect a display device such as a computer monitor. It is used to transmit audio and video simultaneously. The interface, which is developed by VESA, delivers higher performance features than any other digital interface.

### BIOS Setting

Configure the display devices in the Chipset menu ("System Agent Configuration" submenu) of the BIOS. Refer to the chapter 7 for more information.

## I/O Connectors

### Power Connector

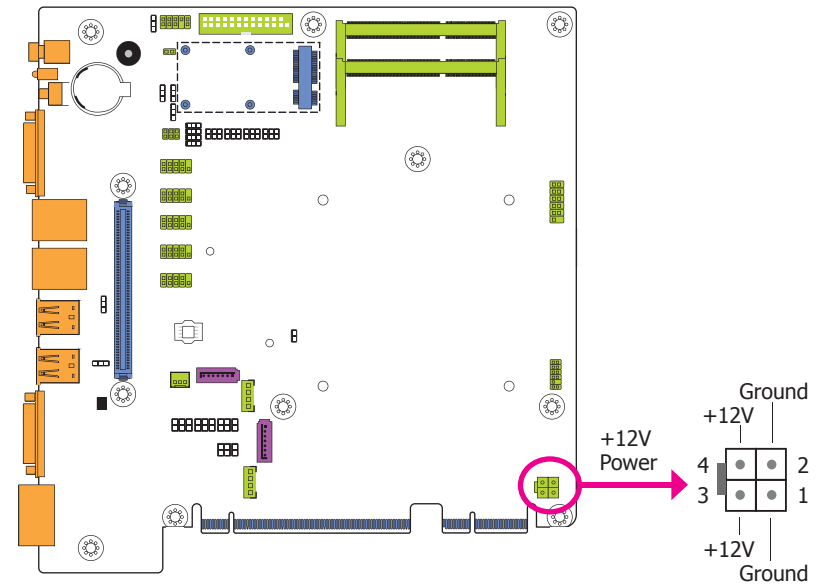

Use a power supply that complies with the ATX12V Power Supply Design Guide Version 1.1. An ATX12V power supply unit has a standard 4-pin ATX main power connector that must be inserted into the 4-pin connector.

The power connector from the power supply unit are designed to fit the 4-pin connector in only one orientation. Make sure to find the proper orientation before plugging the connectors.



#### Important:

Insufficient power supplied to the system may result in instability or the add-in boards and peripherals not functioning properly. Calculating the system's approximate power usage is important to ensure that the power supply meets the system's consumption requirements.

### Parallel Connector

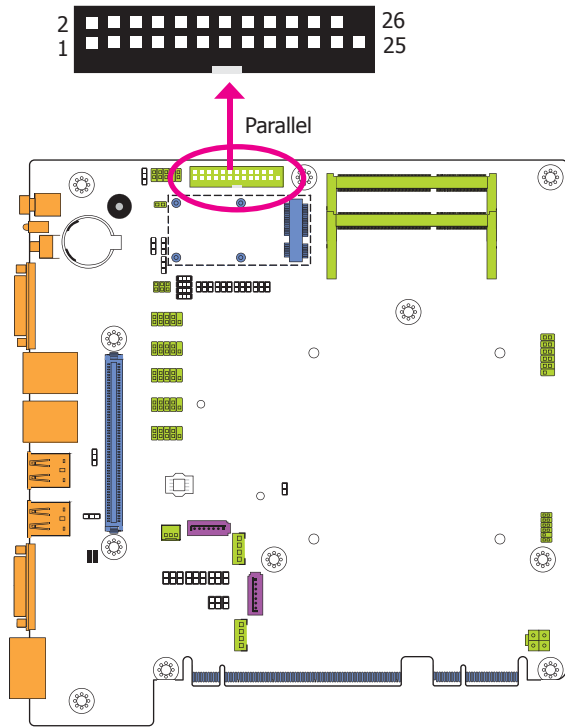

The 25-pin connector is used to connect an external parallel port. The parallel port connects your PC to a parallel printer. It supports SPP, ECP and EPP.

<b>SPP (Standard Parallel Port)</b>	Allows normal speed operation but in one direction only.
<b>ECP (Extended Capabilities Port)</b>	Allows parallel port to operate in bidirectional mode and at a speed faster than the SPP's data transfer rate.
<b>EPP (Enhanced Parallel Port)</b>	Allows bidirectional parallel port operation at maximum speed.

### Front Panel Connector

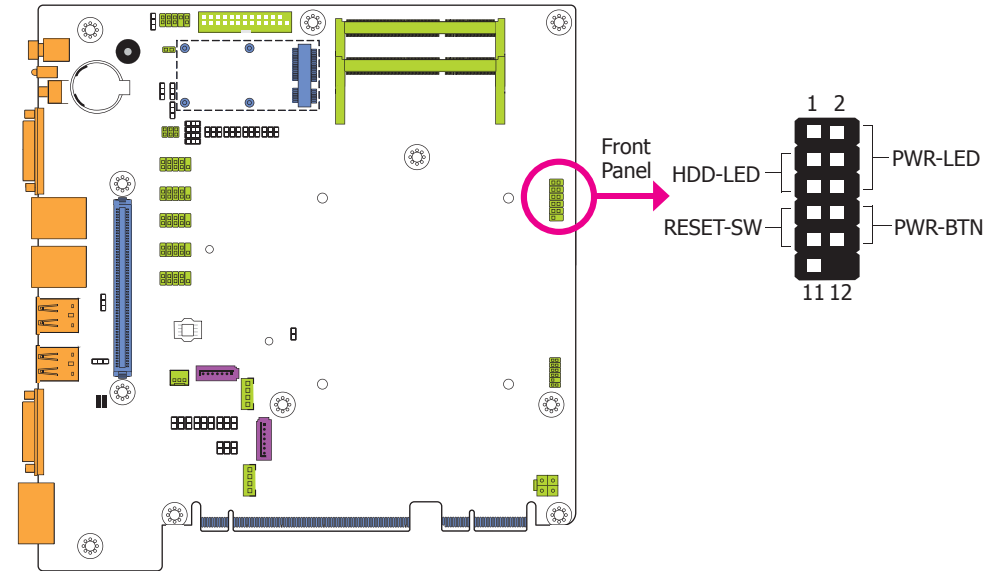

#### HDD-LED - HDD LED

This LED will light when the hard drive is being accessed.

#### RESET SW - Reset Switch

This switch allows you to reboot without having to power off the system.

#### PWR-BTN - Power Switch

This switch is used to power on or off the system.

#### PWR-LED - Power/Standby LED

When the system's power is on, this LED will light. When the system is in the S1 (POS - Power On Suspend) state, it will blink every second. When the system is in the S3 (STR - Suspend To RAM) state, it will blink every 4 seconds.

	Pin	Pin Assignment		Pin	Pin Assignment
<b>HDD-LED</b>	3	HDD Power	<b>PWR-LED</b>	2	LED Power
	5	Signal		4	LED Power
	7	Ground		6	Signal
<b>RESET SW</b>	9	RST Signal	<b>PWR-BTN</b>	8	Ground
	11	N.C.		10	Signal

## Cooling Fan Connectors

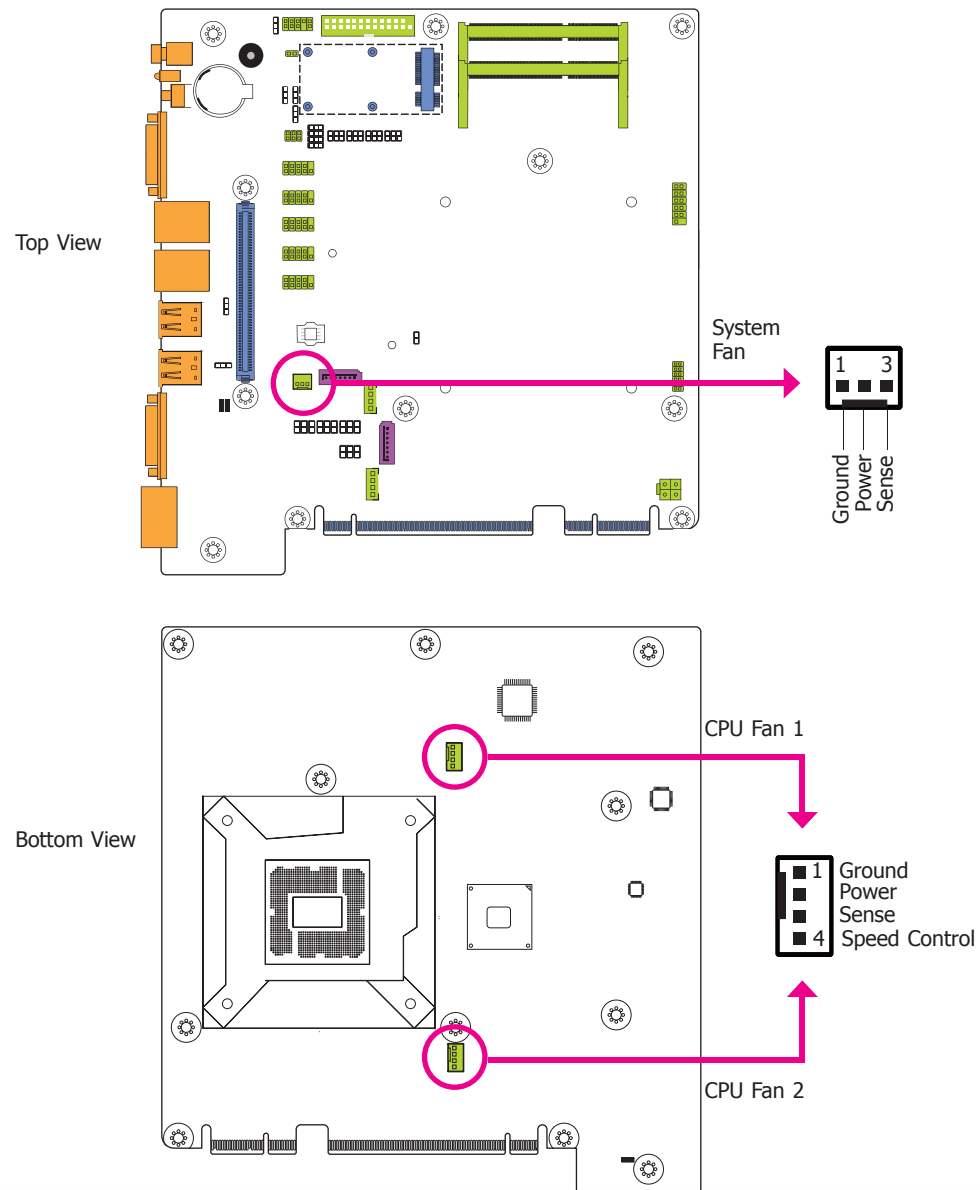

The fan connectors are used to connect cooling fans. The cooling fans will provide adequate airflow throughout the chassis to prevent overheating the CPU and system board components.

### BIOS Setting

The Advanced menu ("PC Health Status" submenu) of the BIOS will display the current speed of the cooling fans. Refer to chapter 7 for more information.

## SMBus Connector

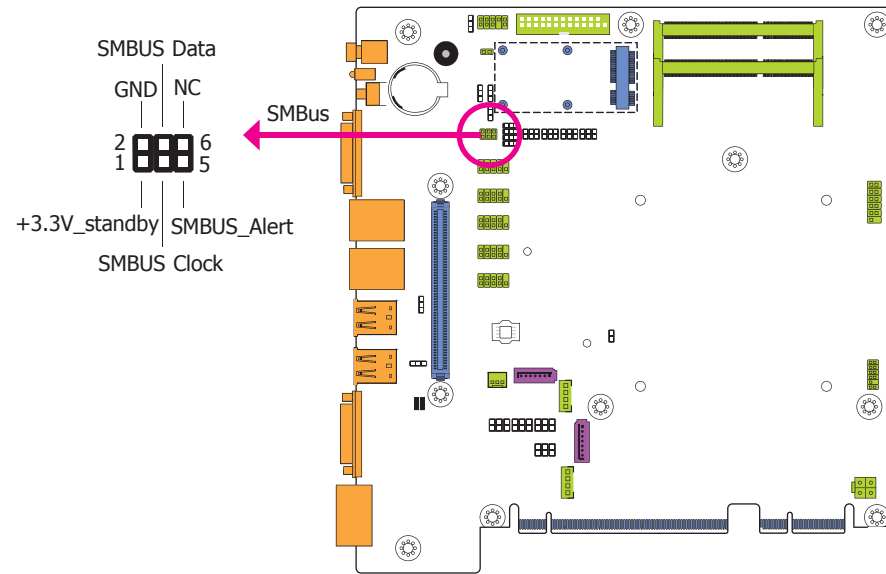

The SMBus (System Management Bus) connector is used to connect SMBus devices. It is a multiple device bus that allows multiple chips to connect to the same bus and enable each one to act as a master by initiating data transfer.

## Chassis Intrusion Connector

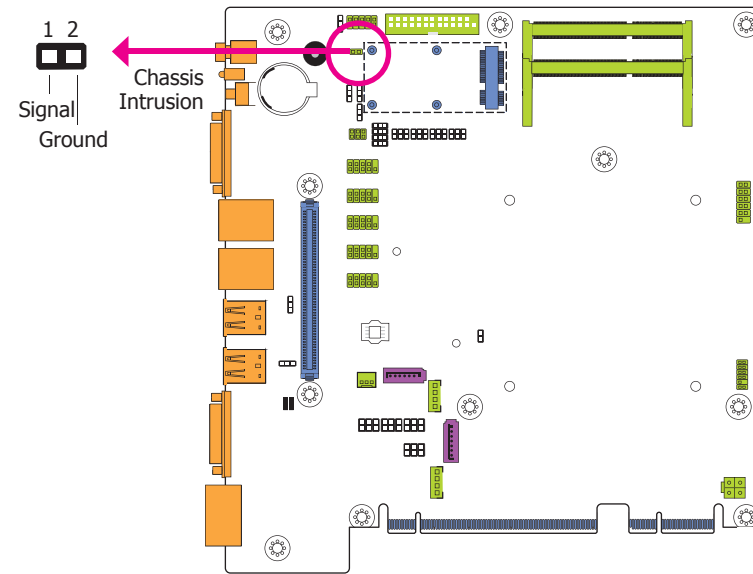

The board supports the chassis intrusion detection function. Connect the chassis intrusion sensor cable from the chassis to this connector. When the system's power is on and a chassis intrusion occurred, an alarm will sound. When the system's power is off and a chassis intrusion occurred, the alarm will sound only when the system restarts.



## SATA (Serial ATA) Connectors

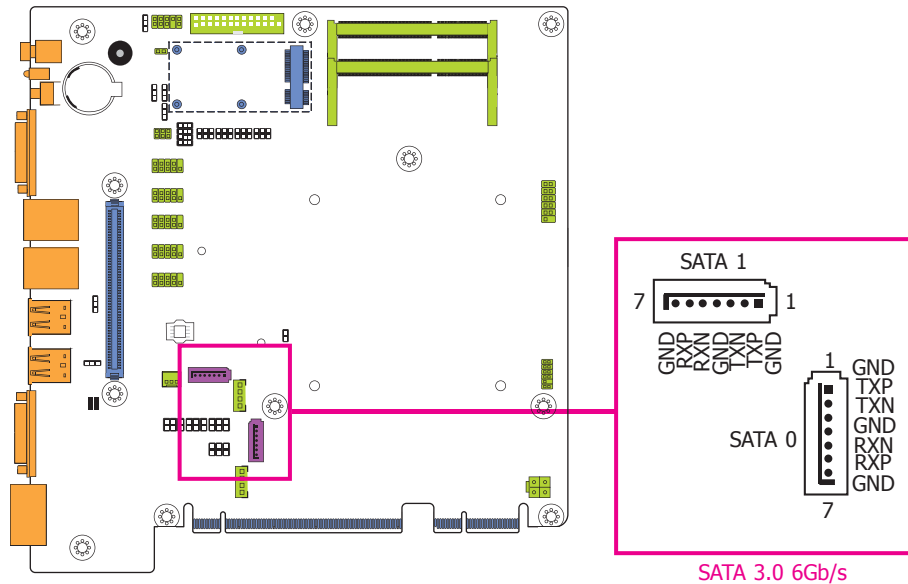

### Features

- 2 Serial ATA 3.0 ports
  - SATA port 0 and 1 with data transfer rate up to 6Gb/s
- Integrated Advanced Host Controller Interface (AHCI) controller

The Serial ATA connectors are used to connect the Serial ATA device. Connect one end of the Serial ATA data cable to a SATA connector on the system board and the other end to your Serial ATA device.

The power cable must be connected from the system board's Serial ATA power connector to the SATA drive's power connector in order to provide power to the drive.

### BIOS Setting

Configure the Serial ATA drives in the Advanced submenu ("SATA Configuration" section) of the BIOS. Refer to chapter 7 for more information.

## SATA (Serial ATA) Power Connectors

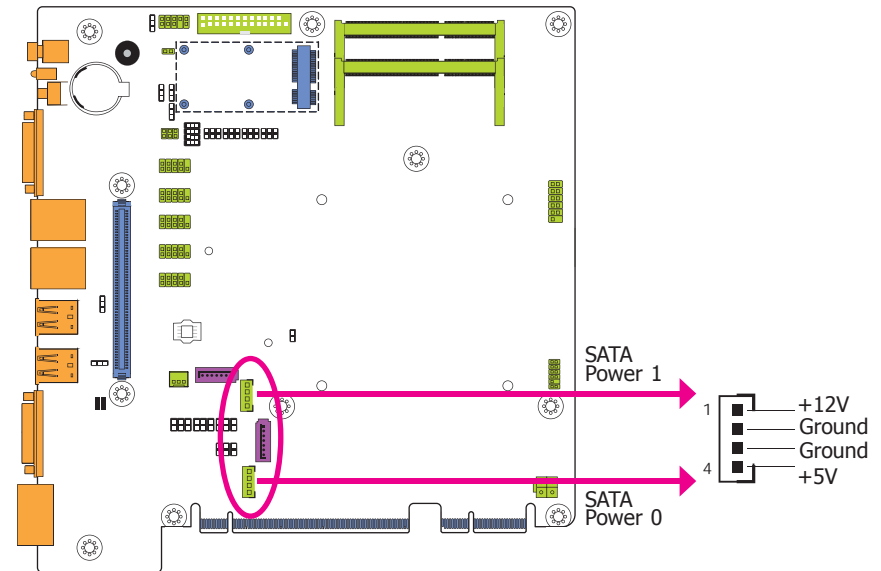

These SATA power connectors supply power to the SATA drive. Connect one end of the provided power cable to the SATA power connector and the other end to your storage device.

## PS/2 Keyboard/Mouse Connector

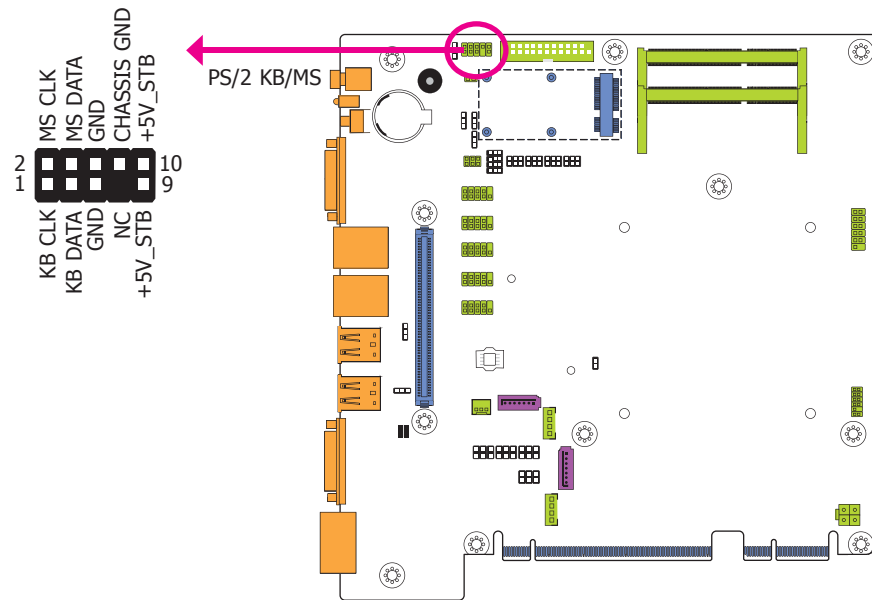

The Keyboard/Mouse connector is used to connect PS/2 keyboard and PS/2 mouse by means of a PS/2 cable. Connect one end of the cable to the Keyboard/Mouse connector. The other ends are used to connect a PS/2 keyboard and a PS/2 mouse.

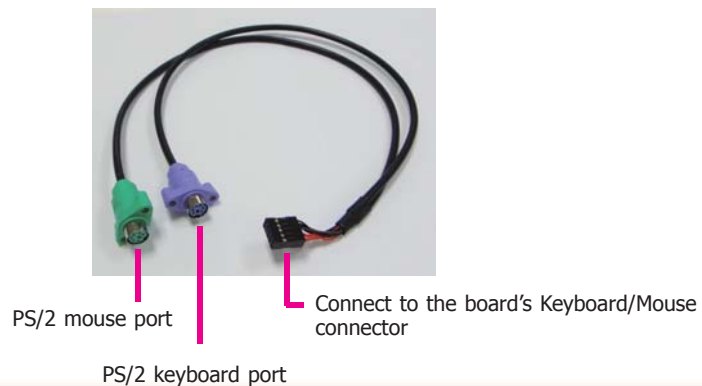

### Wake-On-PS/2 Keyboard/Mouse

The Wake-On-PS/2 Keyboard/Mouse function allows you to use the PS/2 keyboard or PS/2 mouse to power-on the system. To use this function:

- **Jumper Setting**

JP3 must be set to "2-3 On: 5V\_standby". Refer to "PS/2 Keyboard/Mouse Power Select" in chapter 4 for more information.



**Important:**

The 5V\_standby power source of your power supply must support  $\geq 720\text{mA}$ .

## Expansion Slots

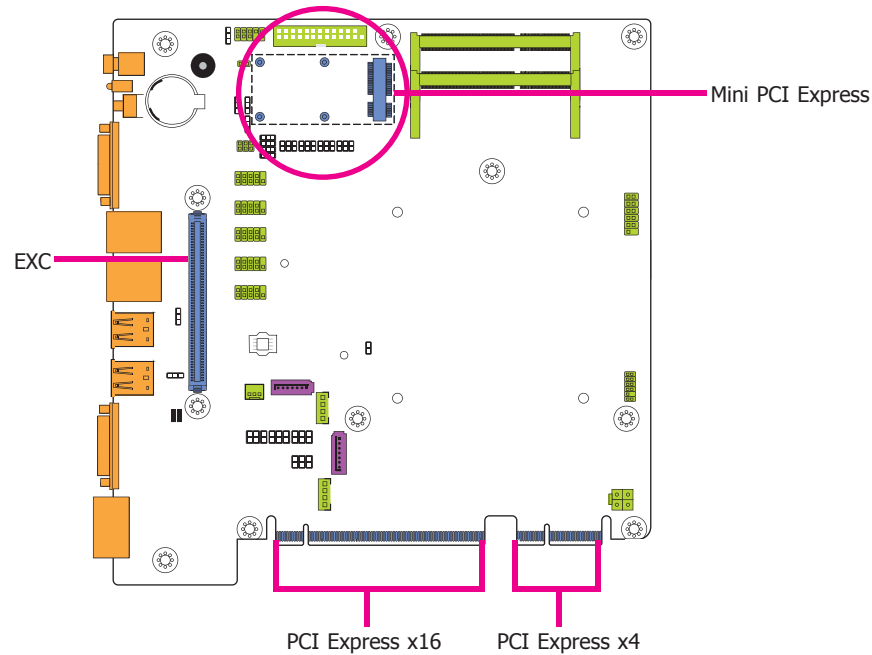

### EXC Slot

The EXC interface is used to install an EXC card for I/O expansion.

### Mini PCIe Slot

The Mini PCIe socket is used to install a Mini PCIe card. Mini PCIe card is a small form factor PCI card with the same signal protocol, electrical definitions, and configuration definitions as the conventional PCI.

### PCI Express x16 Slot

Install PCI Express x16 graphics card, that comply to the PCI Express specifications, into the PCI Express x16 slot. To install a graphics card into the x16 slot, align the graphics card above the slot then press it down firmly until it is completely seated in the slot. The retaining clip of the slot will automatically hold the graphics card in place.

### PCI Express x4 Slot

Install PCI Express cards such as network cards or other cards that comply to the PCI Express specifications into the PCI Express x4 slot.

## Standby Power LED

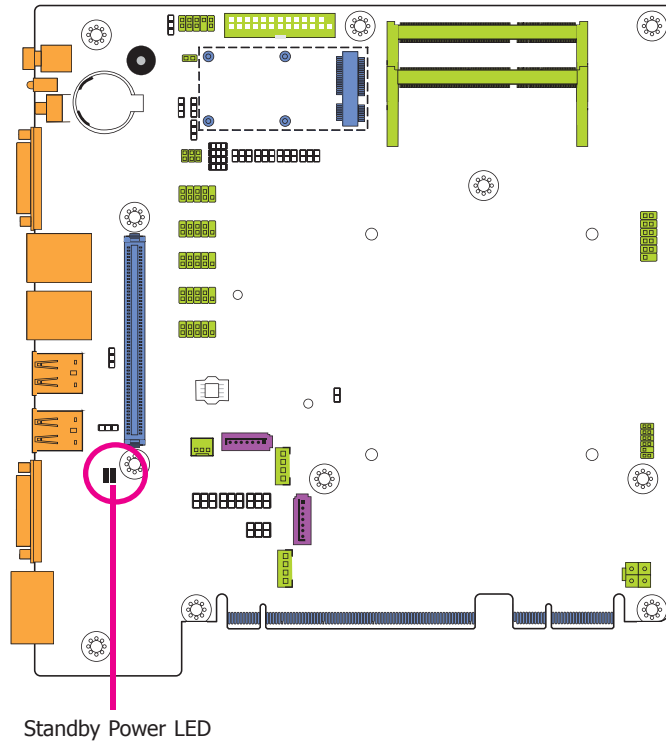

This LED will lit red when the system is in the standby mode. It indicates that there is power on the system board. Power-off the PC and then unplug the power cord prior to installing any devices. Failure to do so will cause severe damage to the motherboard and components.

## Battery

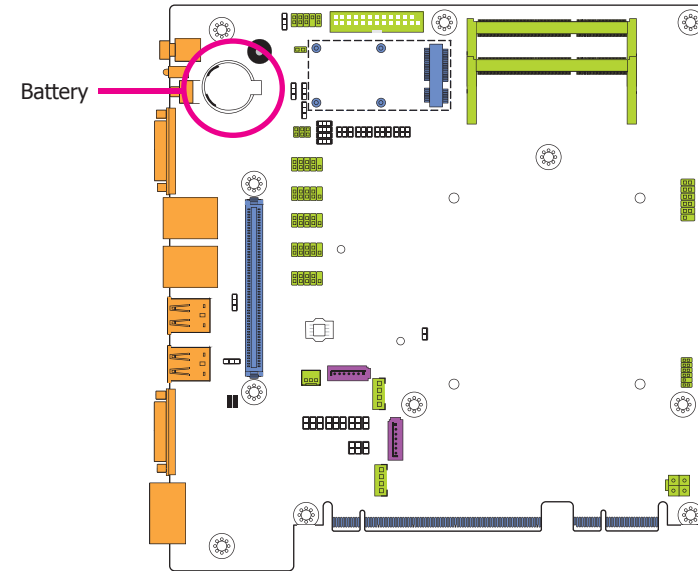

The lithium ion battery powers the real-time clock and CMOS memory. It is an auxiliary source of power when the main power is shut off.

### Safety Measures

- Danger of explosion if battery incorrectly replaced.
- Replace only with the same or equivalent type recommend by the manufacturer.
- Dispose of used batteries according to local ordinance.

## Chapter 6 - Mounting Options

### Wall Mount - Type 1

The wall mount kit includes the followings:

- 2 Wall mount brackets
- Bracket screws

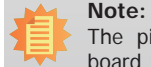

**Note:**

The pictures in this document are used for illustration pupose only. The system board and all other components may differ depending on the configuration you have purchased. Please refer to the provided DVD for details relevant to the system board.

1. The mounting holes are located on the bottom side of the system unit.

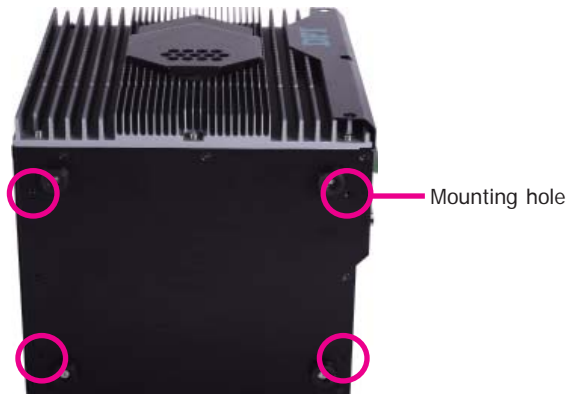

2. Remove the mounting screws from the bottom side of the system unit.



3. Use the provided mounting screws to secure the wallmount brackets on each side of the system.



4. Mount the whole system on the wall by fastening the screws through the mounting holes.

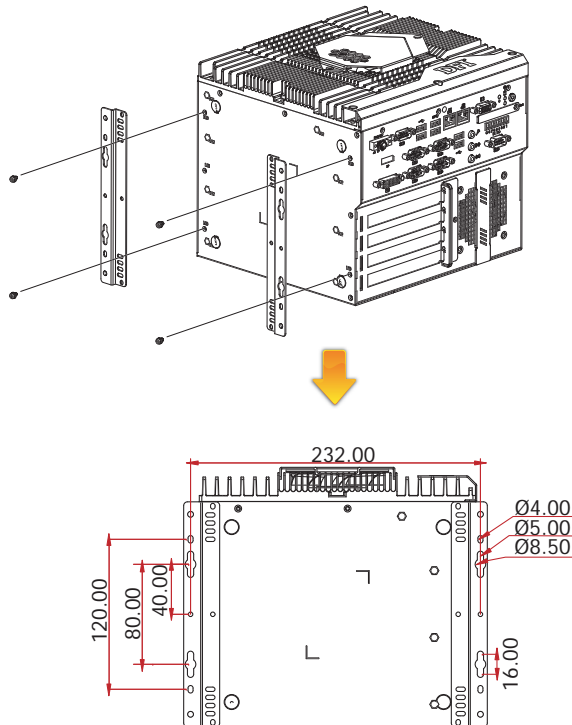
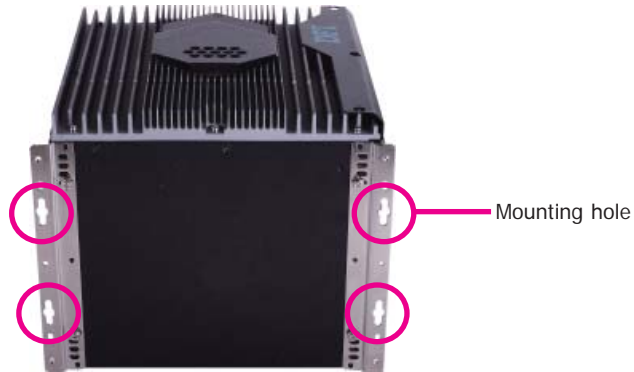

## Wall Mount - Type 2

The wall mount kit includes the followings:

- 2 Wall mount brackets
- Bracket screws



**Note:**

The pictures in this document are used for illustration pupose only. The system board and all other components may differ depending on the configuration you have purchased. Please refer to the provided DVD for details relevant to the system board.

1. The mounting holes are located on the one side of the system unit.

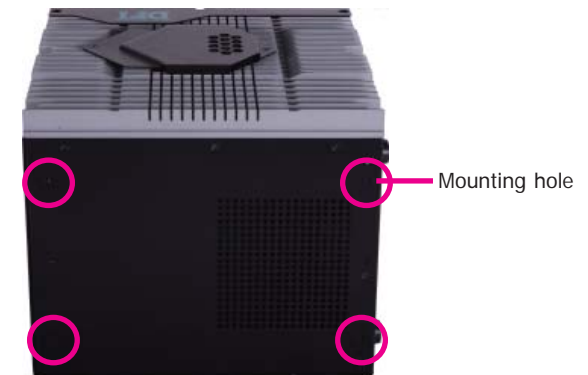

2. Use the provided mounting screws to secure the wallmount brackets on each side of the system.



3. Mount the whole system on the wall by fastening the screws through the mounting holes.

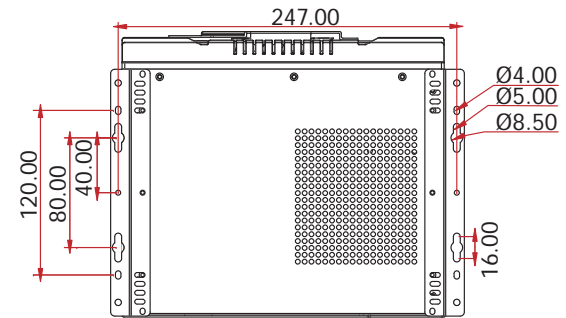
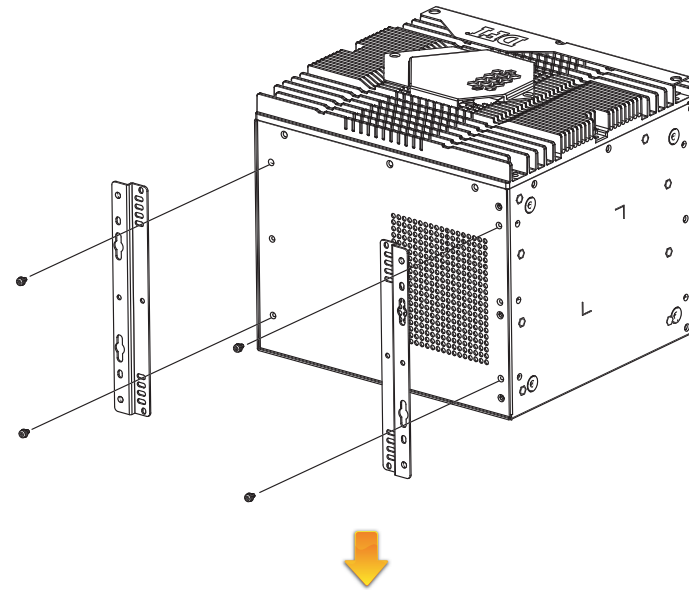
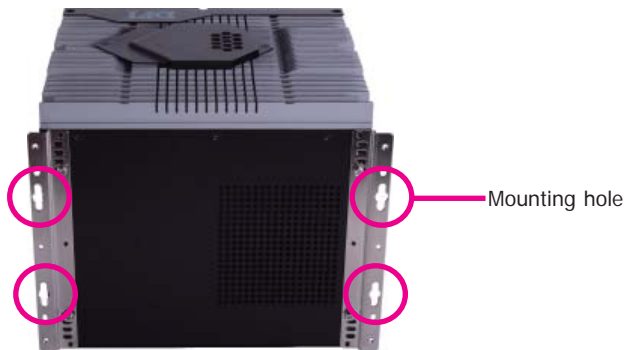

## Chapter 7 - BIOS Setup

### Overview

The BIOS is a program that takes care of the basic level of communication between the CPU and peripherals. It contains codes for various advanced features found in this system board. The BIOS allows you to configure the system and save the configuration in a battery-backed CMOS so that the data retains even when the power is off. In general, the information stored in the CMOS RAM of the EEPROM will stay unchanged unless a configuration change has been made such as a hard drive replaced or a device added.

It is possible that the CMOS battery will fail causing CMOS data loss. If this happens, you need to install a new CMOS battery and reconfigure the BIOS settings.



#### Note:

The BIOS is constantly updated to improve the performance of the system board; therefore the BIOS screens in this chapter may not appear the same as the actual one. These screens are for reference purpose only.

### Default Configuration

Most of the configuration settings are either predefined according to the Load Optimal Defaults settings which are stored in the BIOS or are automatically detected and configured without requiring any actions. There are a few settings that you may need to change depending on your system configuration.

### Entering the BIOS Setup Utility

The BIOS Setup Utility can only be operated from the keyboard and all commands are keyboard commands. The commands are available at the right side of each setup screen.

The BIOS Setup Utility does not require an operating system to run. After you power up the system, the BIOS message appears on the screen and the memory count begins. After the memory test, the message "Press DEL to run setup" will appear on the screen. If the message disappears before you respond, restart the system or press the "Reset" button. You may also restart the system by pressing the <Ctrl> <Alt> and <Del> keys simultaneously.

### Legends

Keys	Function
Right and Left arrows	Moves the highlight left or right to select a menu.
Up and Down arrows	Moves the highlight up or down between submenu or fields.
<Esc>	Exit to the BIOS Setup Utility.
+ (plus key)	Scrolls forward through the values or options of the highlighted field.
- (minus key)	Scrolls backward through the values or options of the highlighted field.
Tab	Select a field.
<F1>	Displays General Help
<F2>	Pervious values
<F3>	Optimized defaults
<F4>	Saves and resets the setup program
<Enter>	Press <Enter> to enter the highlighted submenu.

### Scroll Bar

When a scroll bar appears to the right of the setup screen, it indicates that there are more available fields not shown on the screen. Use the up and down arrow keys to scroll through all the available fields.

### Submenu

When "▶" appears on the left of a particular field, it indicates that a submenu which contains additional options are available for that field. To display the submenu, move the highlight to that field and press <Enter>.



## AMI BIOS Setup Utility

### Main

The Main menu is the first screen that you will see when you enter the BIOS Setup Utility.

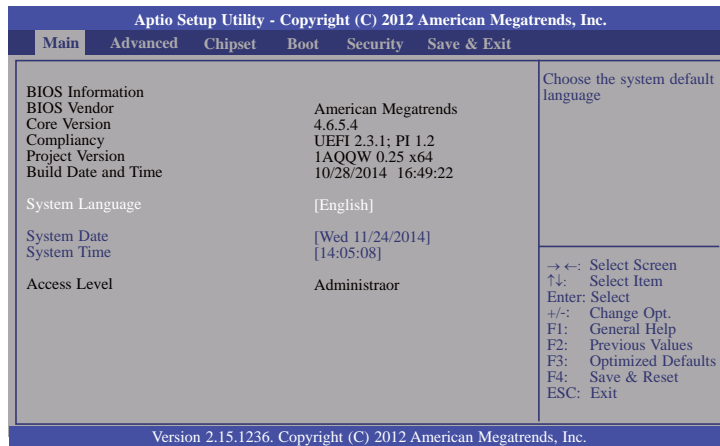

#### System Date

The date format is <day>, <month>, <date>, <year>. Day displays a day, from Sunday to Saturday. Month displays the month, from January to December. Date displays the date, from 1 to 31. Year displays the year, from 1980 to 2099.

#### System Time

The time format is <hour>, <minute>, <second>. The time is based on the 24-hour military-time clock. For example, 1 p.m. is 13:00:00. Hour displays hours from 00 to 23. Minute displays minutes from 00 to 59. Second displays seconds from 00 to 59.

### Advanced

The Advanced menu allows you to configure your system for basic operation. Some entries are defaults required by the system board, while others, if enabled, will improve the performance of your system or let you set some features according to your preference.



#### Important:

Setting incorrect field values may cause the system to malfunction.

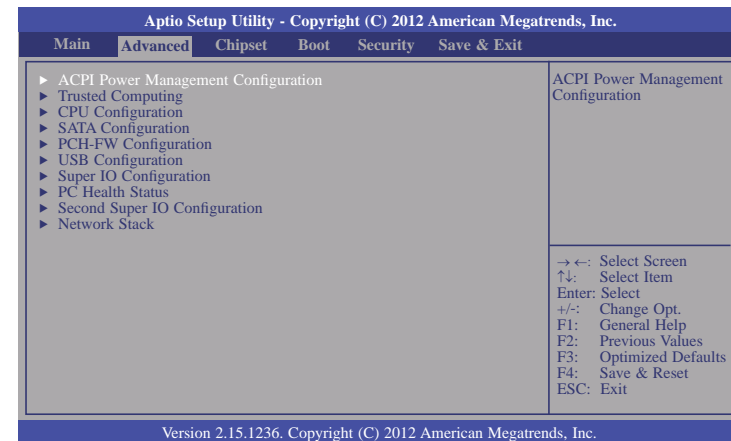

### ACPI Power Management Configuration

This section is used to configure the ACPI power management.

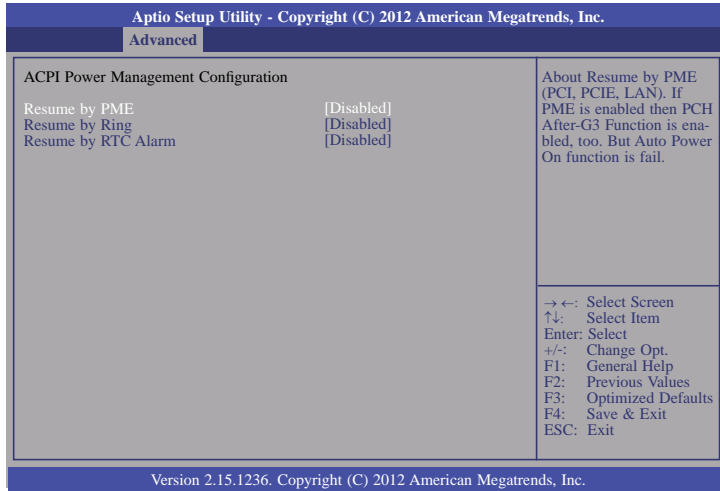

#### Resume by PME

Enables this field to use the PME signal to wake up the system.

#### Resume by Ring

Enables this field to use the Ring signal to wake up the system.

#### Resume by RTC Alarm

When Enabled, the system uses the RTC to generate a wakeup event.

### Trusted Computing

This section configures settings relevant to Trusted Computing innovations.

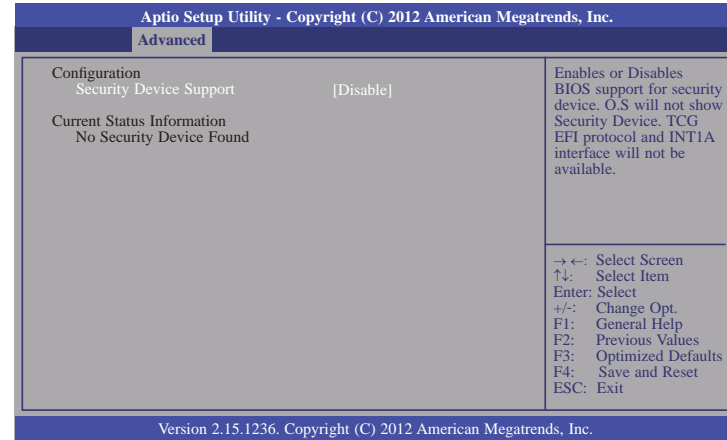

#### Security Device Support

This field is used to enable or disable BIOS supporting for the security device. O.S will not show the security device. TCG EFI protocol and INT1A interface will not be available.

## CPU Configuration

This section is used to configure the CPU. It will also display the detected CPU information.

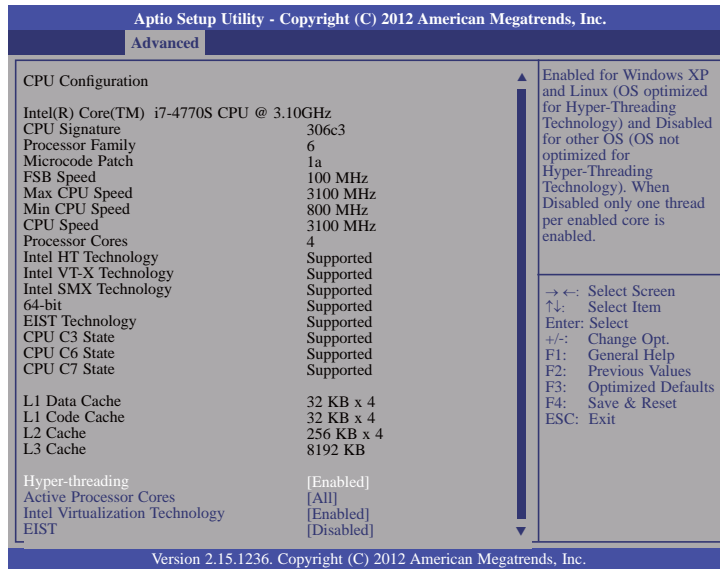

### Hyper-threading

Enables this field for Windows XP and Linux which are optimized for Hyper-Threading technology. Select disabled for other OSes not optimized for Hyper-Threading technology. When disabled, only one thread per enabled core is enabled.

### Active Processor Cores

Number of cores to enable in each processor package.

### Intel Virtualization Technology

When this field is set to Enabled, the VMM can utilize the additional hardware capabilities provided by Vanderpool Technology.

### EIST

This field is used to enable or disable the Intel Enhanced SpeedStep Technology.

## SATA Configuration

This section is used to configure the settings of Serial ATA devices.

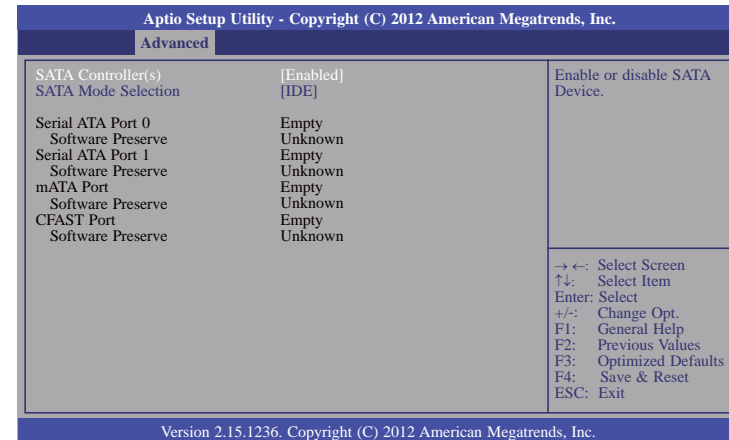

### SATA Controller(s)

This field is used to enable or disable the Serial ATA devices.

### SATA Mode Selection

The mode selection determines how the SATA controller(s) operates.

### IDE Mode

This option configures the Serial ATA drives as Parallel ATA storage devices.

### AHCI Mode

This option allows the Serial ATA devices to use AHCI (Advanced Host Controller Interface).

When IDE mode is selected in the SATA Mode Selection, it will display the following information:

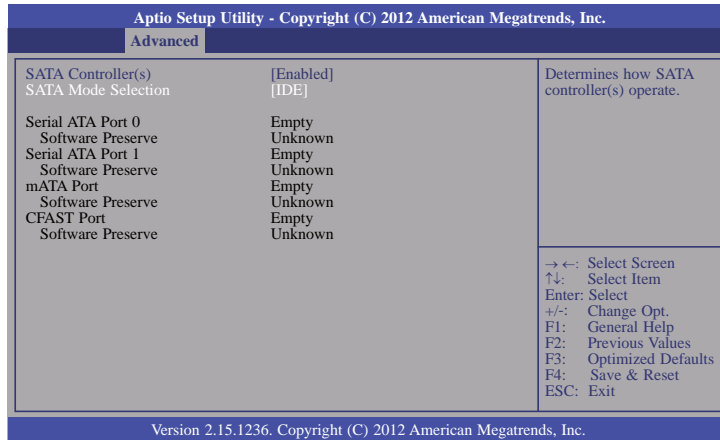

## SATA Controller Speed

Indicates the maximum speed that the Serial ATA controller can support.

## Port 0, Port 1, mSATA Port, CFAST Port

Enables or disables these Serial ATA ports.

## Hot Plug

Designates the serial ATA port as hot pluggable.

When AHCI mode is selected in the SATA Mode Selection, it will display the following information:

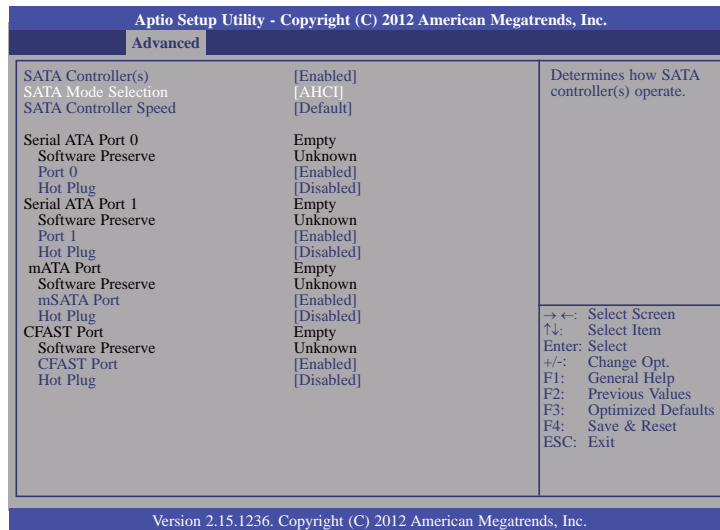

## PCH-FW Configuration

This section is used to configure the parameters of Management Engine Technology.

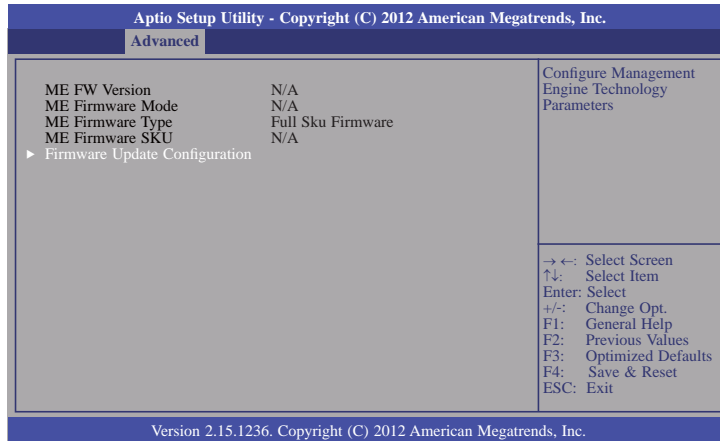

## Firmware Update Configuration

Enables or disables the Me FW Image Re-Flash function.

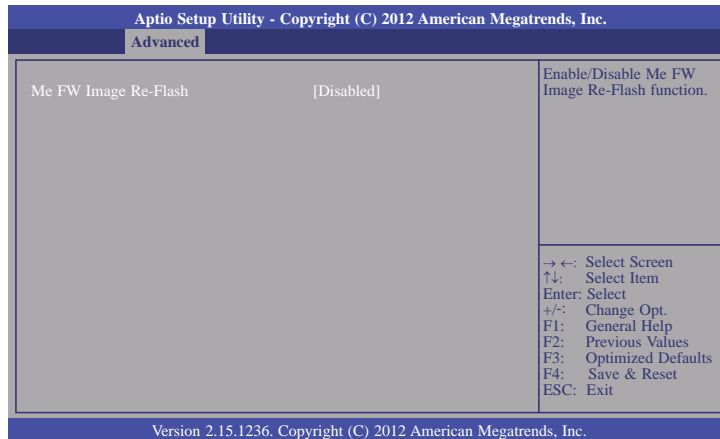

## USB Configuration

This section is used to configure USB.

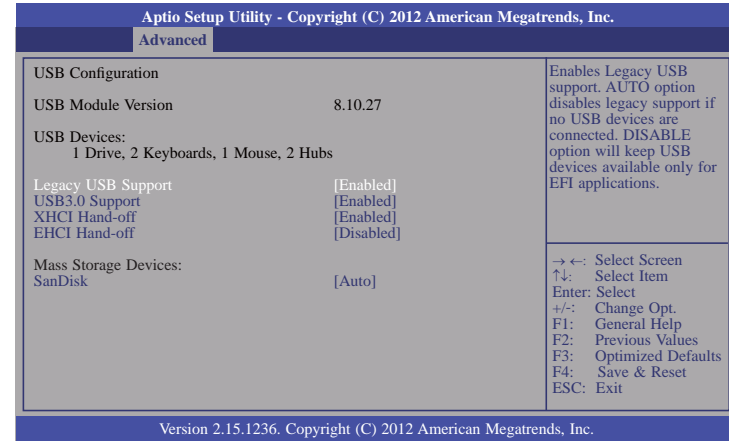

## Legacy USB Support

### Enabled

Enables legacy USB.

### Auto

Disables support for legacy when no USB devices are connected.

### Disabled

Keeps USB devices available only for EFI applications.

## USB3.0 Support

Enable or disable the support of the USB 3.0 (XHCI) controller.

## XHCI Hand-off

This is a workaround for OSES without the support of XHCI hand-off. The change of XHCI ownership should be claimed by the XHCI driver.

## EHCI Hand-off

This is a workaround for OSES without the support of EHCI hand-off. The change of EHCI ownership should be claimed by the EHCI driver.

## Super IO Configuration

This section is used to configure the I/O functions supported by the onboard Super I/O chip.

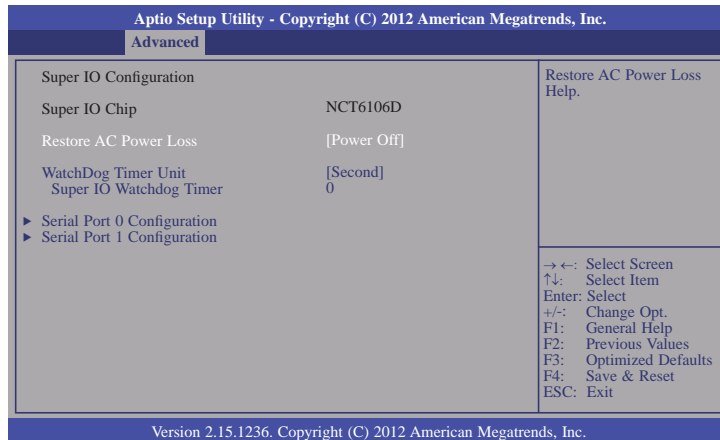

### Restore AC Power Loss

#### Power Off

When power returns after an AC power failure, the system's power is off. You must press the Power button to power-on the system.

#### Power On

When power returns after an AC power failure, the system will automatically power-on.

#### Last State

When power returns after an AC power failure, the system will return to the state where you left off before power failure occurs. If the system's power is off when AC power failure occurs, it will remain off when power returns. If the system's power is on when AC power failure occurs, the system will power-on when power returns.

### Watchdog Timer Unit

Selects the watchdog timer unit: second or minute.

### Super IO Watchdog Timer

Sets the timeout value of the super IO watchdog timer. 0 means disabled.

## Serial Port 0 Configuration and Serial Port 1 Configuration

Sets parameters of serial port 0 (COM A) and serial port 1 (COM B).

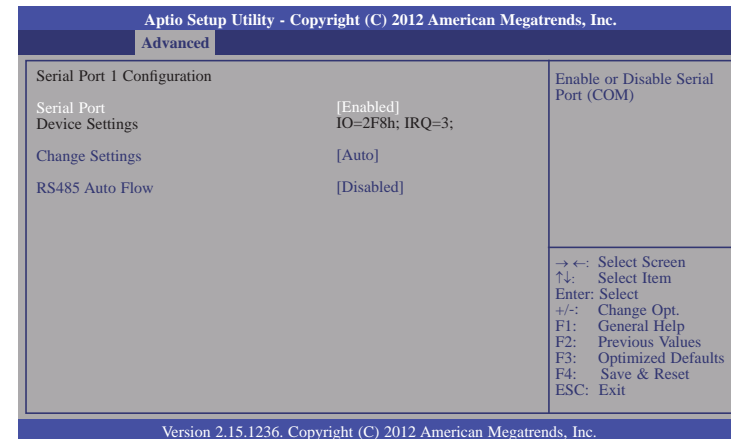
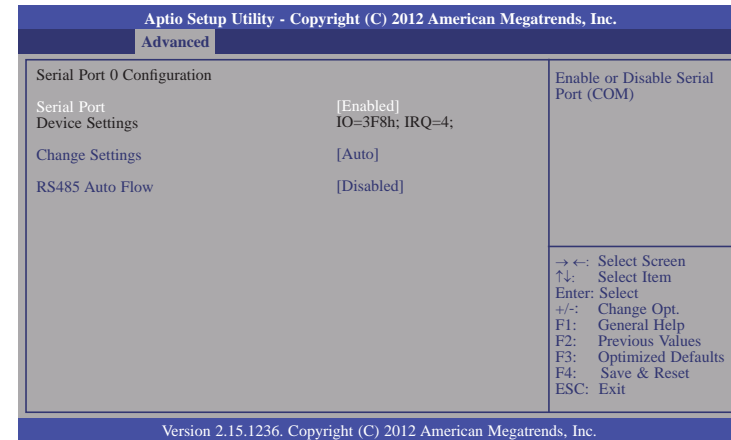

## Serial Port

Enables or disables the serial port (COM).

## Change Settings

Selects the IO/IRQ settings for the super I/O device.

## RS485 Auto Flow

Sets the RS485 auto flow for the serial port.

## PC Health Status

This section displays the hardware health monitor.

Aptio Setup Utility - Copyright (C) 2012 American Megatrends, Inc.

Advanced

PC Health Status ▶ Smart Fan Function Case Open [Disabled] CPU Temperature : +45.5 C System Temperature : +34.5 C CPU Fan 1 Speed : 1945 RPM CPU Fan 2 Speed : N/A System Fan Speed : N/A VCore : +1.808 V +5V : +5.038 V +12V : +12.232 V +1.5V : +1.536 V +3.3V : +3.312 V 3VSB : +3.408 V VBAT : +3.072 V	Smart Fan Function Setting  → ←: Select Screen ↑↓: Select Item Enter: Select +/-: Change Opt. F1: General Help F2: Previous Values F3: Optimized Defaults F4: Save & Reset ESC: Exit
--	--

Version 2.15.1236. Copyright (C) 2012 American Megatrends, Inc.

## Smart Fan Function

Aptio Setup Utility - Copyright (C) 2012 American Megatrends, Inc.

Advanced

Smart Fan Function CPU Smart Fan (1) Control [Enabled] Boundary 4 60 Boundary 3 50 Boundary 2 40 Boundary 1 30 Speed Count 5 100 Speed Count 4 75 Speed Count 3 50 Speed Count 2 40 Speed Count 1 30 CPU Smart Fan (2) Control [Enabled] Boundary 4 60 Boundary 3 50 Boundary 2 40 Boundary 1 30 Speed Count 5 100 Speed Count 4 75 Speed Count 3 50 Speed Count 2 40 Speed Count 1 30 System Smart Fan Control [Enabled] Boundary 4 60 Boundary 3 50 Boundary 2 40 Boundary 1 30 Speed Count 5 100 Speed Count 4 75 Speed Count 3 50 Speed Count 2 40 Speed Count 1 30	Enable CPU Smart Fan  → ←: Select Screen ↑↓: Select Item Enter: Select +/-: Change Opt. F1: General Help F2: Previous Values F3: Optimized Defaults F4: Save & Reset ESC: Exit
---	--

Version 2.15.1236. Copyright (C) 2012 American Megatrends, Inc.

## CPU Smart Fan Control

When this feature is set to Automatic, the CPU's fan speed will rotate according to the CPU's temperature. The higher the temperature, the faster the speed of rotation.

## System Smart Fan Control

When this feature is set to Automatic, the System's fan speed will rotate according to the System's temperature. The higher the temperature, the faster the speed of rotation.

## Boundary 1 to Boundary 4

The range is 0-127.

## Speed Count 1 to Speed Count 5

The range is 1-100%.

## Case Open

Sets this field to Enabled to allow the system to alert you of a chassis intrusion event.

## Second Super IO Configuration

This section is used to configure the parameters of the system second super I/O chip.

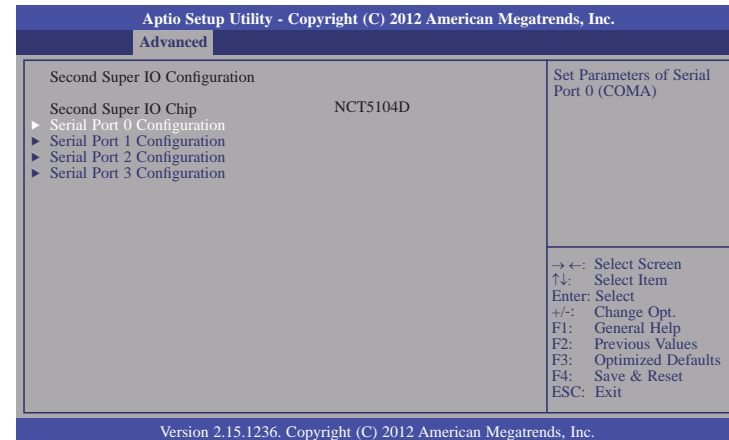

## Serial Port 0 Configuration to Serial Port 3 Configuration

Sets parameters of serial port 0 (COM A) to serial port 3 (COM D).

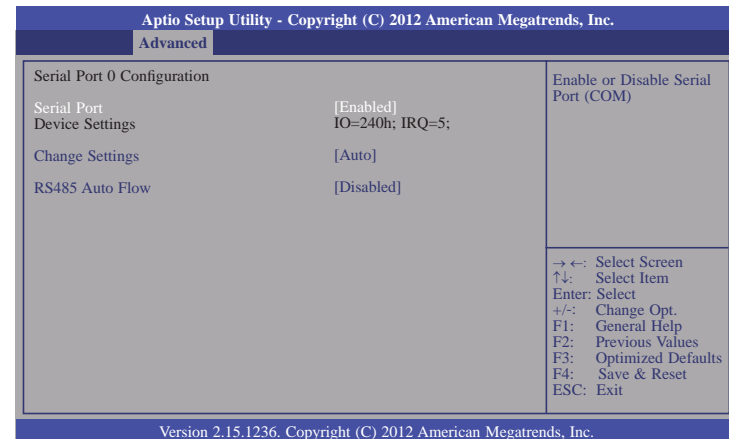



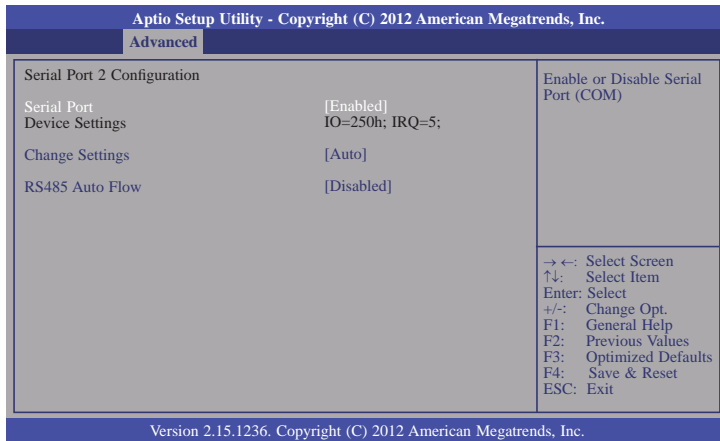
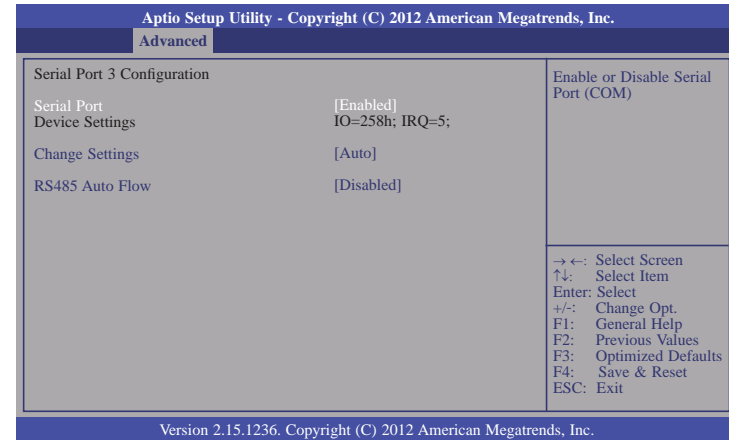
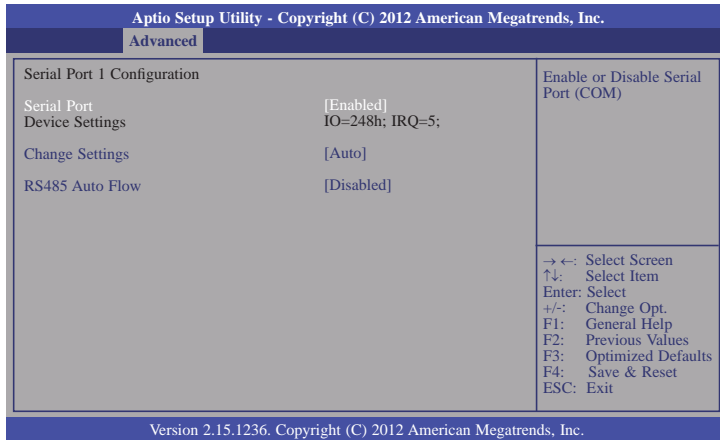

## Serial Port

Enables or disables the serial port (COM).

## Change Settings

Selects the IO/IRQ settings for the super I/O device.

## RS485 Auto Flow

Sets the RS485 auto flow for the serial port.

## Network Stack

This section is used to enable or disable UEFI network stack.

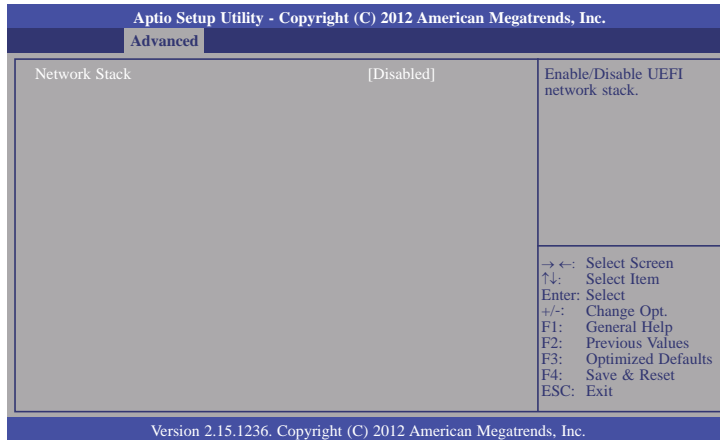

When Network Stack is enabled, it will display the following information:

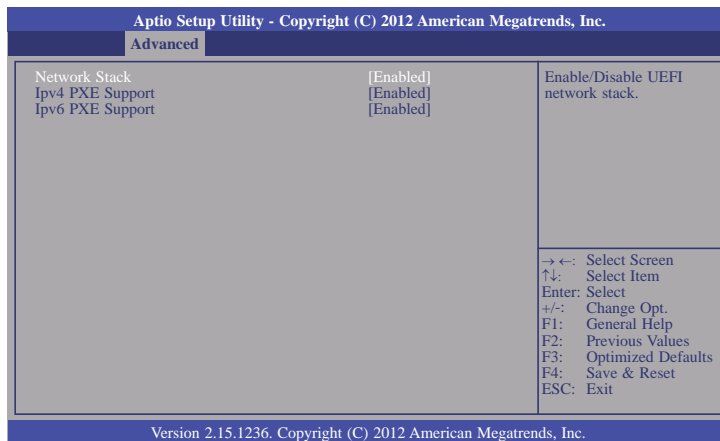

## Ipv4 PXE Support

When enabled, Ipv4 PXE boot supports. When disabled, Ipv4 PXE boot option will not be created.

## Ipv6 PXE Support

When enabled, Ipv6 PXE boot supports. When disabled, Ipv6 PXE boot option will not be created.

## Chipset

This section configures relevant chipset functions.

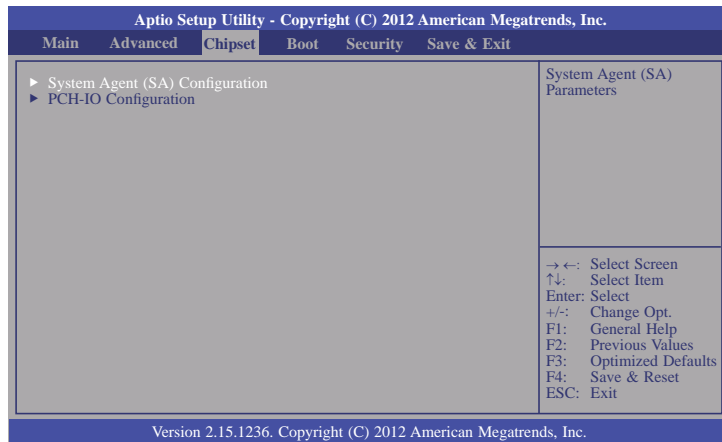

## System Agent (SA) Configuration

This section is used to configure the parameters of System Agent.

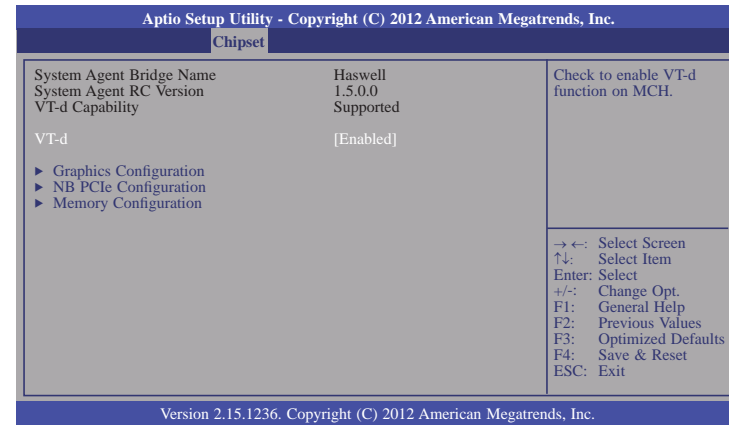

### VT-d

Checks to enable VT-d function on MCH.

## Graphics Configuration

This field configures the graphics settings.

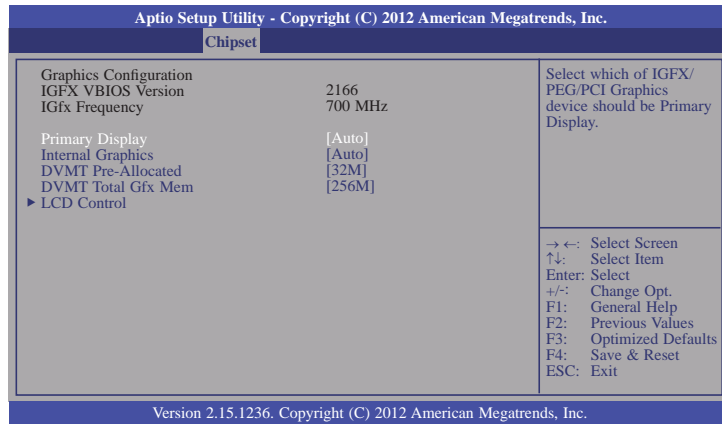

### Primary Display

- Auto** When the system boots, it will auto detects the display device.
- IGFX** When the system boots, it will first initialize the onboard VGA.
- PEG** When the system boots, it will first initialize the PCI Express x16 graphics card.

### Internal Graphics

Keeps IGD enabled based on the setup options.

## DVMT Pre-Allocated

Selects DVMT 5.0 Pre-Allocated (Fixed) Graphics Memory size used by the Internal Graphics Device. Please refer to the information below.

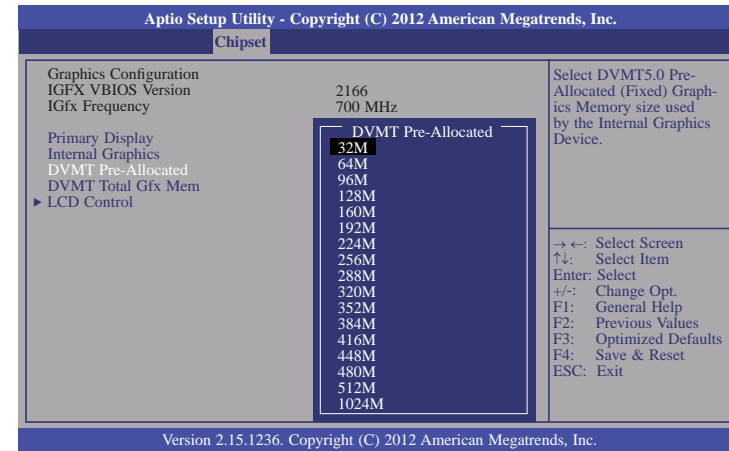

## DVMT Total Gfx Mem

Selects DVMT 5.0 total graphics memory size used by the internal graphics device. Please refer to the information below.

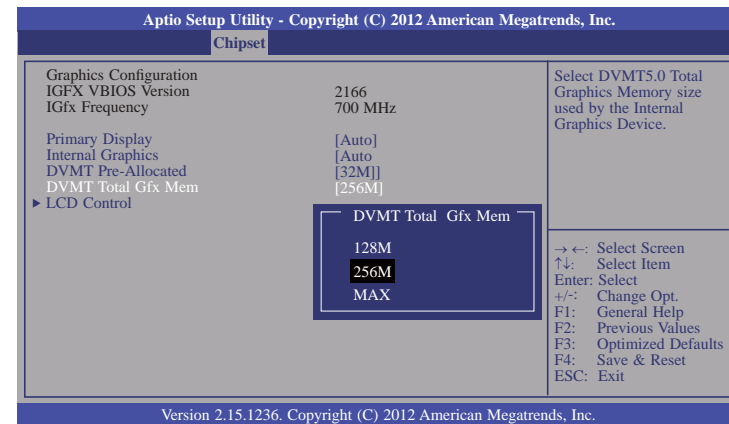

## LCD Control

This field configures the LCD control.

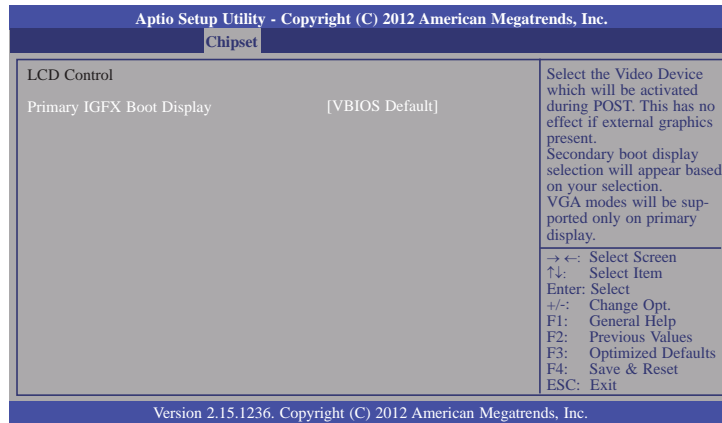

When any device is selected in the Primary IGFX Boot Display, it will display the following information:

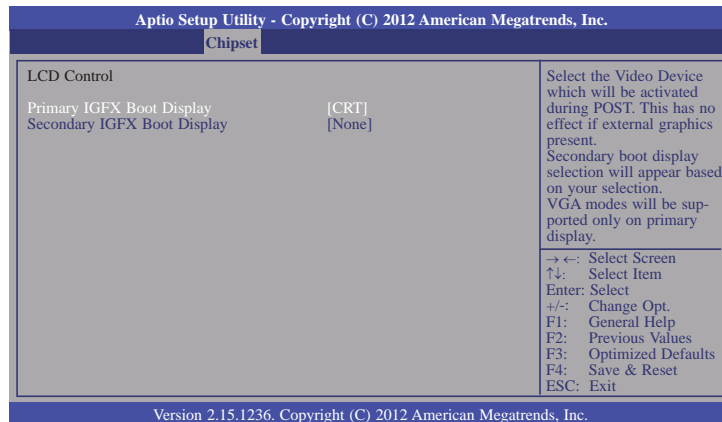

## Secondary IGFX Boot Display

Selects the secondary display device.

## NB PCIe Configuration

This field is used to configure the settings of NB PCI Express.

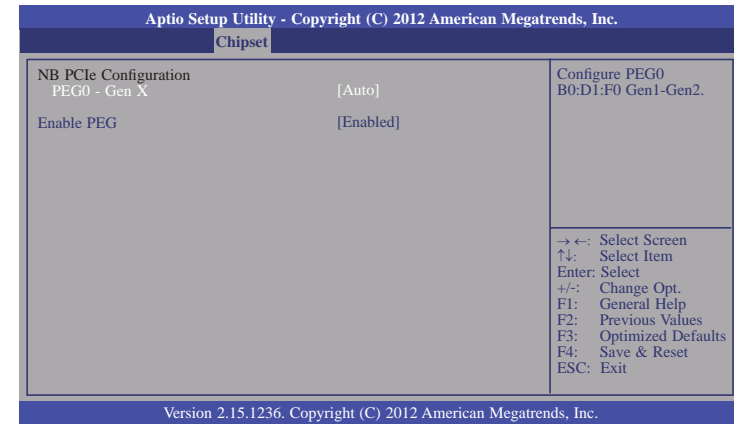

## Enable PEG

Enables or disables the PEG.

## Memory Configuration

This field only displays the memory configuration.

Aptio Setup Utility - Copyright (C) 2012 American Megatrends, Inc.		
Chipset		
Memory Information		
Memory RC Version	1.5.0.0	
Memory Frequency	1600 Mhz	
Total Memory	2048 MB (DDR3)	
Memory Voltage	1.50V	
DIMM#1	Not Present	
DIMM#2	2048 MB (DDR3)	
CAS Latency (tCL)	11	
Minimum delay time		
CAS to RAS (tRCDmin)	11	
Row Precharge (tRPmin)	11	
Active to Precharge (tRASmin)	28	
		→ ←: Select Screen ↑↓: Select Item Enter: Select +/-: Change Opt. F1: General Help F2: Previous Values F3: Optimized Defaults F4: Save & Reset ESC: Exit
Version 2.15.1236. Copyright (C) 2012 American Megatrends, Inc.		

## PCH-IO Configuration

This section illustrates the PCH parameters.

Aptio Setup Utility - Copyright (C) 2012 American Megatrends, Inc.		
Chipset		
Intel PCH RC Version	1.5.0.0	PCI Express Configuration settings.
Intel PCH SKU Name	H81	
Intel PCH Rev ID	05/C2	
▶ PCI Express Configuration		
▶ USB Configuration		
▶ PCH Azalia Configuration		
Onboard I217 LAN Controller	[Enabled]	
Onboard I210 LAN Controller	[Enabled]	
<b>High Precision Event Timer Configuration</b>		
High Precision Timer	[Enabled]	
		→ ←: Select Screen ↑↓: Select Item Enter: Select +/-: Change Opt. F1: General Help F2: Previous Values F3: Optimized Defaults F4: Save & Reset ESC: Exit
Version 2.15.1236. Copyright (C) 2012 American Megatrends, Inc.		

### Onboard I217 LAN Controller

Enables or disables the onboard I217 LAN controller.

### Onboard I210 LAN Controller

Enables or disables the onboard I210 LAN controller

### High Precision Timer

Enables or disables the High Precision Event Timer.

## PCI Express Configuration

This field is used to configure the PCI Express settings.

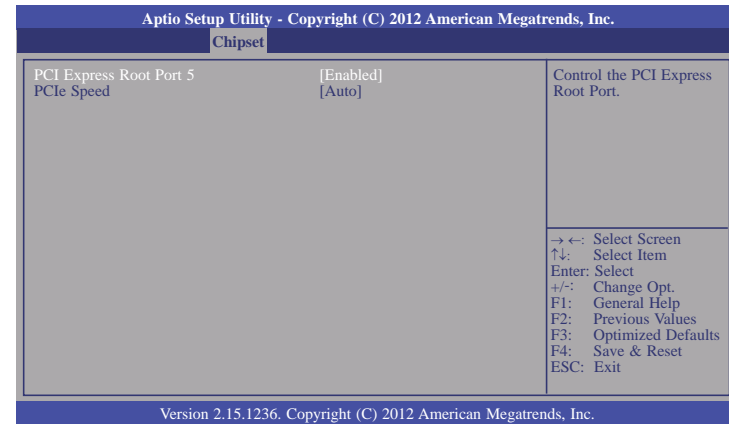
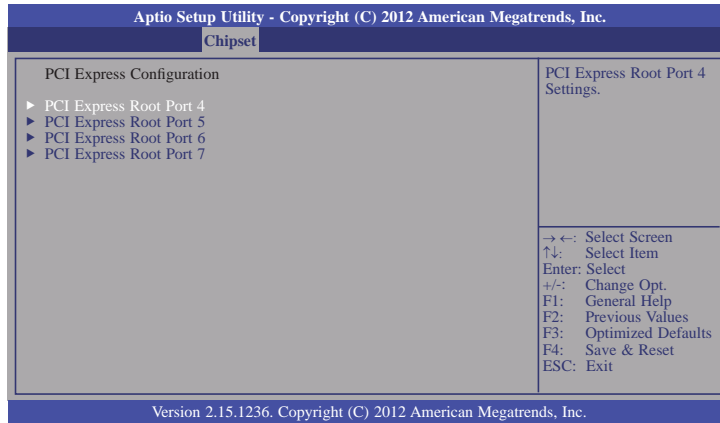

## PCI Express Root Port 4 to PCI Express Root Port 7

Enables or disables the PCI Express Root Port.

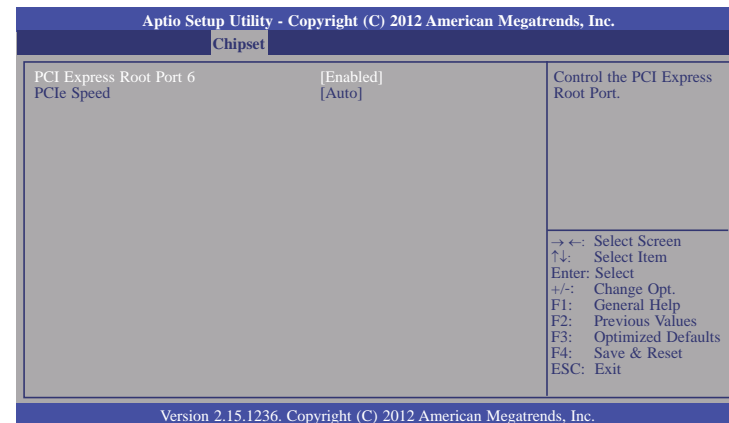
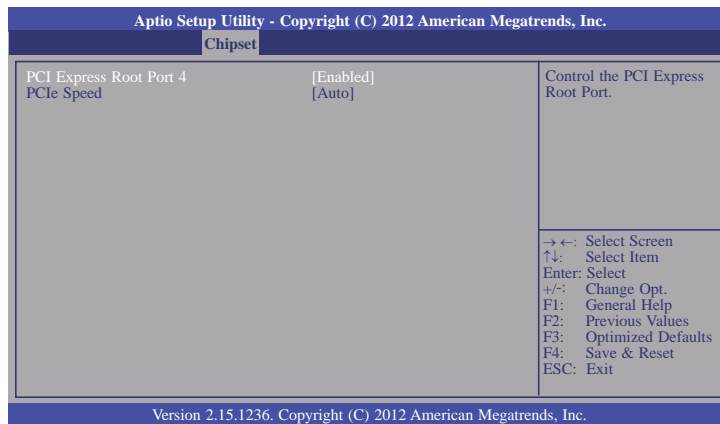

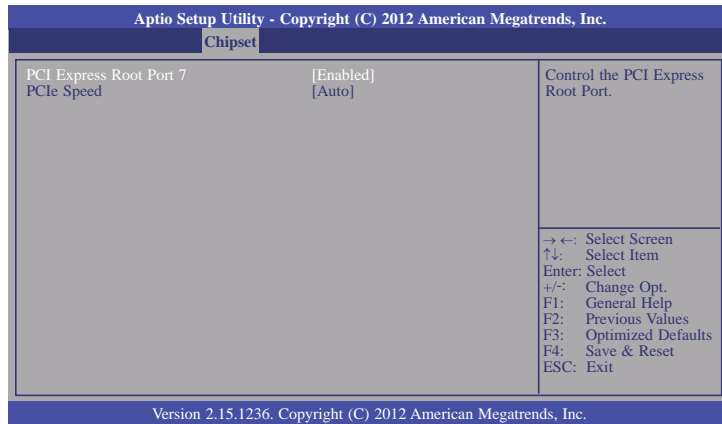

### PCIe Speed

Selects the speed of PCI Express port: Auto, Gen 1 or Gen 2.

### USB Configuration

This field is used to configure the USB settings.

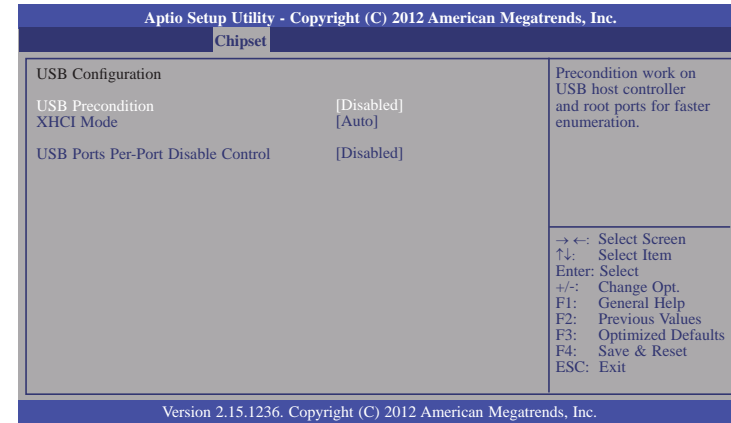

### USB Precondition

Precondition works on USB host controller and root ports for faster enumeration.



**XHCI Mode**

Selects the operation mode of XHCI controller. These options are Auto, Enabled, and Disabled. When Disabled is selected in the XHCI Mode, it will display the following information:

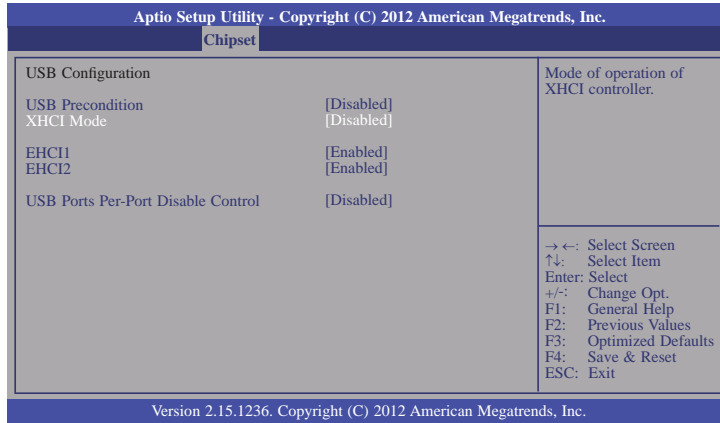

**EHCI 1 and EHCI 2**

These fields are used to control the functions of USB EHCI (USB 2.0) controllers. One EHCI controller must always be enabled.

**USB Ports Per-Port Disable Control**

This field is used to control each of the USB ports (0~13) disabling. When enabled, it will display the following information:

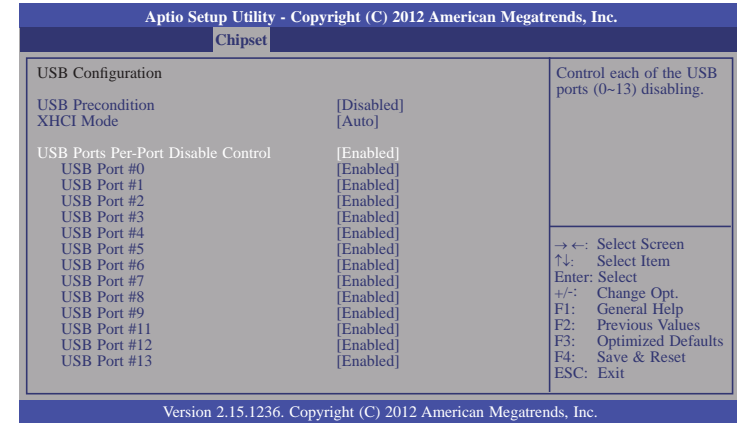

**USB Port #0/1/2/3/4/5/6/7/8/9/11/12/13**

Enables or disables these USB ports.

## PCH Azalia Configuration

This field is used to configure the PCH Azalia settings.

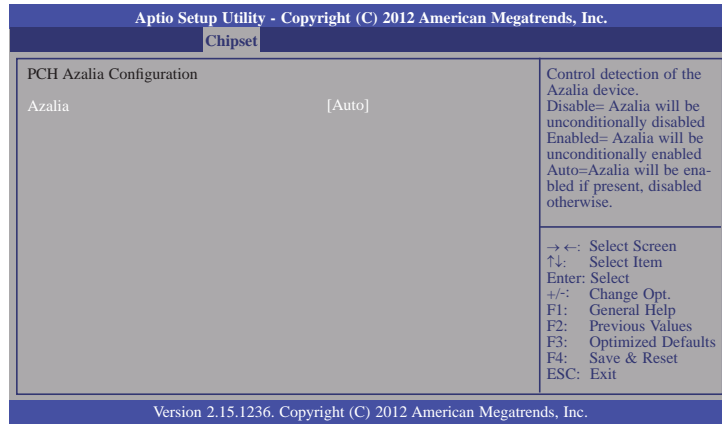

## Boot

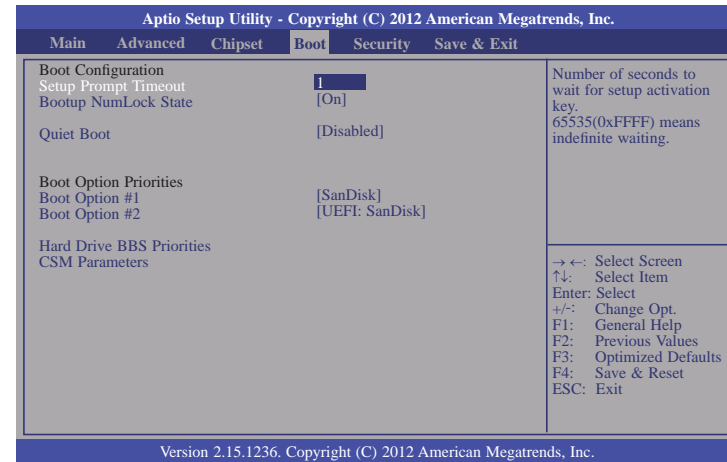

### Setup Prompt Timeout

Selects the number of seconds to wait for the setup activation key. 65535(0xFFFF) denotes indefinite waiting.

### Bootup NumLock State

This allows you to determine the default state of the numeric keypad. By default, the system boots up with NumLock on wherein the function of the numeric keypad is the number keys. When set to Off, the function of the numeric keypad is the arrow keys.

### Quiet Boot

Enables or disables the quiet boot function.

### Boot Option

Sets the system boot order.

### Hard Drive BBS Priorities

Sets the order of the legacy devices in the group.

## CSM Parameters

Aptio Setup Utility - Copyright (C) 2012 American Megatrends, Inc.					
Main	Advanced	Chipset	Boot	Security	Save & Exit
Launch CSM			[Enabled]		This option controls if CSM will be launched.
Boot option filter			[UEFI and Legacy]		
Launch PXE OpROM policy			[Do not launch]		
Launch Storage OpROM policy			[Legacy only]		
Other PCI device ROM priority			[Legacy OpROM]		
					→ ←: Select Screen ↑↓: Select Item Enter: Select +/-: Change Opt. F1: General Help F2: Previous Values F3: Optimized Defaults F4: Save & Reset ESC: Exit
Version 2.15.1236. Copyright (C) 2012 American Megatrends, Inc.					

**Launch CSM**

This option controls if CSM will be launched.

**Boot option filter**

This option controls what devices system can be boot to.

**Launch PXE OpROM policy**

Controls the execution of UEFI and legacy PXE OpROM.

**Launch Storage OpROM policy**

Controls the execution of UEFI and legacy storage OpROM.

**Other PCI device ROM priority**

For PCI devices other than Network, Mass Storage, or Video defines which OpROM to launch.

## Security

Aptio Setup Utility - Copyright (C) 2012 American Megatrends, Inc.					
Main	Advanced	Chipset	Boot	Security	Save & Exit
Password Description				Set Administrator Password.	
If ONLY the Administrator's password is set, then this only limits access to Setup and is only asked for when entering Setup.					
If ONLY the User's password is set, then this is a power on password and must be entered to boot or enter Setup. In Setup the User will have Administrator rights.					
The password length must be in the following range:					
Minimum length				3	
Maximum length				20	
Administrator Password					
User Password					
HDD Security Configuration					
					→ ←: Select Screen ↑↓: Select Item Enter: Select +/-: Change Opt. F1: General Help F2: Previous Values F3: Optimized Defaults F4: Save & Reset ESC: Exit
Version 2.15.1236. Copyright (C) 2012 American Megatrends, Inc.					

**Administrator Password**

Sets the administrator password.

**User Password**

Sets the user password.

## Save & Exit

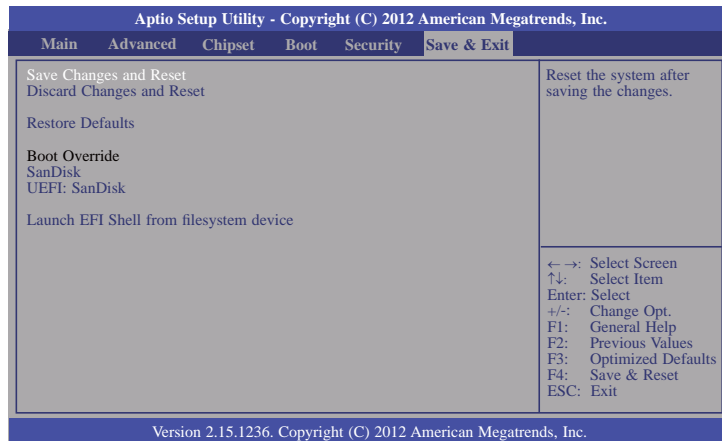

### Save Changes and Reset

To save the changes, select this field and then press <Enter>. A dialog box will appear. Select Yes to reset the system after saving all changes made.

### Discard Changes and Reset

To discard the changes, select this field and then press <Enter>. A dialog box will appear. Select Yes to reset the system setup without saving any changes.

### Restore Defaults

To restore and load the optimized default values, select this field and then press <Enter>. A dialog box will appear. Select Yes to restore the default values of all the setup options.

### Launch EFI Shell from filesystem device

Attempts to Launch EFI Shell application (Shellx64.efi) from one of the available file-system devices.

## Updating the BIOS

To update the BIOS, you will need the new BIOS file and a flash utility, AFUDOS.EXE. Please contact technical support or your sales representative for the files.

To execute the utility, type:

```
A:> AFUDOS BIOS_File_Name /b /p /n
```

then press <Enter>.

```
C:\AFU\AFUDOS>afudos filename /B /P /N
+-----+
|             AMI Firmware Update Utility(APTIO) v2.25             |
|             Copyright (C)2008 American Megatrends Inc. All Rights Reserved. |
+-----+
Reading file ..... done
Erasing flash ..... done
Writing flash ..... done
Verifying flash ..... done
Erasing BootBlock ..... done
Writing BootBlock ..... done
Verifying BootBlock ..... done
C:\AFU\AFUDOS>
```

## Notice: BIOS SPI ROM

1. The Intel® Management Engine has already been integrated into this system board. Due to the safety concerns, the BIOS (SPI ROM) chip cannot be removed from this system board and used on another system board of the same model.
2. The BIOS (SPI ROM) on this system board must be the original equipment from the factory and cannot be used to replace one which has been utilized on other system boards.
3. If you do not follow the methods above, the Intel® Management Engine will not be updated and will cease to be effective.

**Note:**

- a. You can take advantage of flash tools to update the default configuration of the BIOS (SPI ROM) to the latest version anytime.
- b. When the BIOS IC needs to be replaced, you have to populate it properly onto the system board after the EEPROM programmer has been burned and follow the technical person's instructions to confirm that the MAC address should be burned or not.

## Chapter 8 - Supported Software

Some devices of the system require drivers from hardware manufactures to operate properly. The system may come with a CD/DVD that contains drivers, utilities and software applications. Insert the CD into a CD-ROM drive. The auto-run screen (Mainboard Utility CD) will appear. If the "Autorun" does not automatically start, please go to the root directory of the CD and double-click "Setup".

If your product package does not include a CD/DVD, you can download the latest drivers from the DFI Download Center:

<http://www.dfi.com/DownloadCenter>

Once you are in the Download Center page, select your product or type the model name and click "Search" to find product-related resources such as documentation and drivers.

### Auto Run Page (For Windows 8)

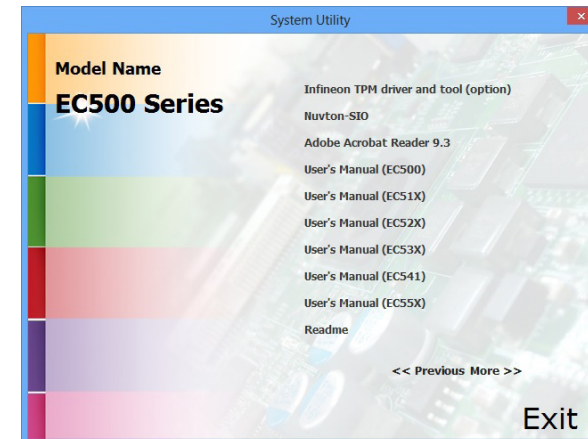

Auto Run Page (For Windows 7)

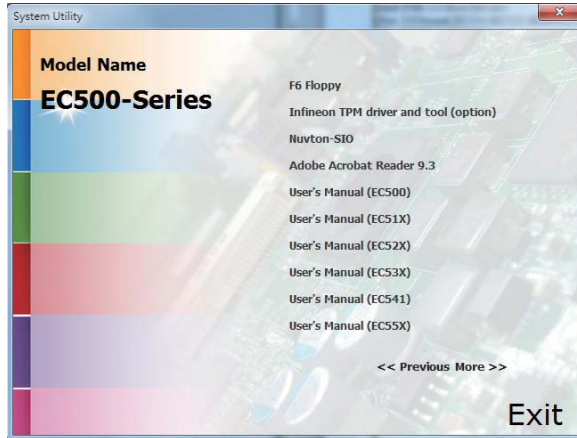
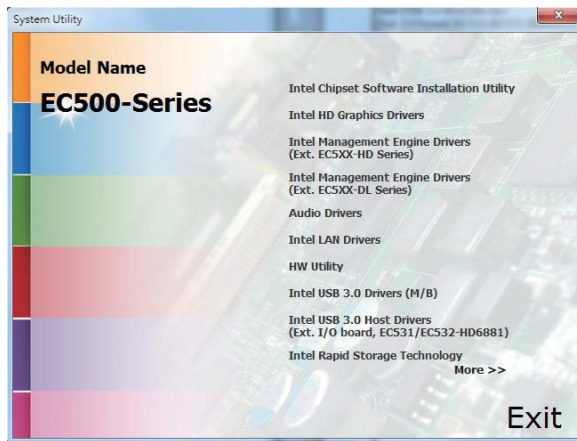

### Auto Run Pages (For Windows XP)

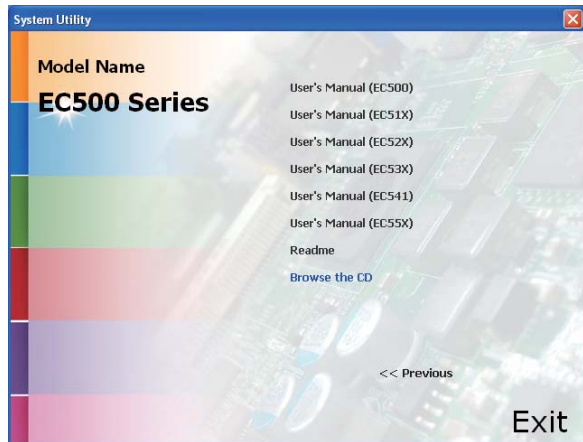
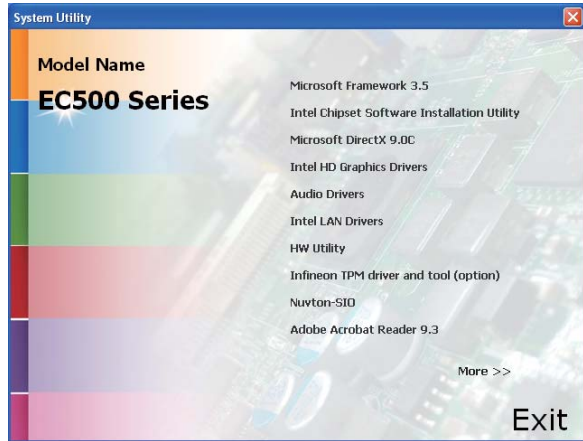

### Microsoft .NET Framework 3.5 (For Windows XP)



**Note:** Before installing Microsoft .NET Framework 3.5, make sure you have updated your Windows XP operating system to Service Pack 3.

To install the driver, click "Microsoft .NET Framework 3.5" on the main menu.

1. Read the license agreement carefully.

Click "I have read and accept the terms of the License Agreement" then click Install.

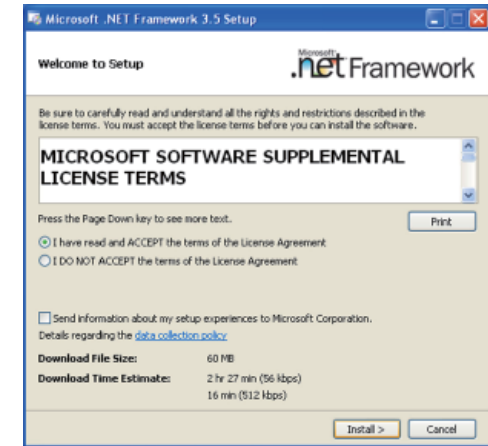

2. Setup is now installing the driver.

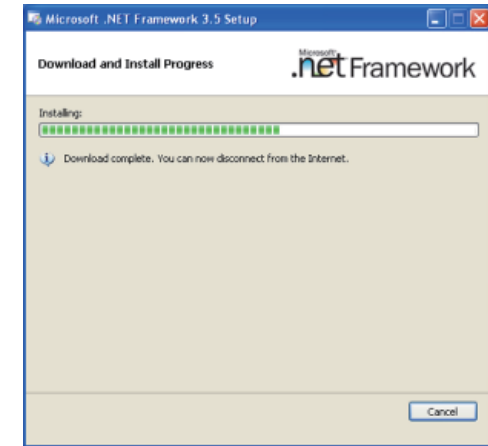



3. Click Exit.

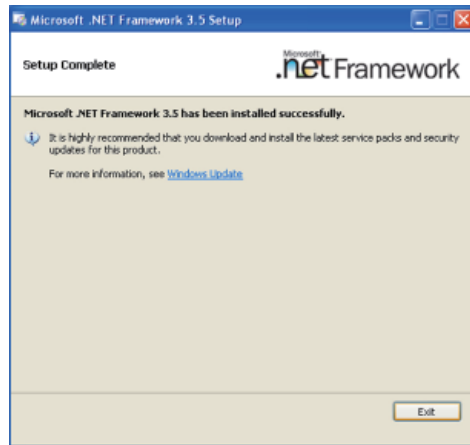

## Intel Chipset Software Installation Utility

The Intel Chipset Software Installation Utility is used for updating Windows® INF files so that the Intel chipset can be recognized and configured properly in the system.

To install the utility, click "Intel Chipset Software Installation Utility" on the main menu.

1. Setup is ready to install the utility. Click Next.



2. Read the license agreement then click Yes.

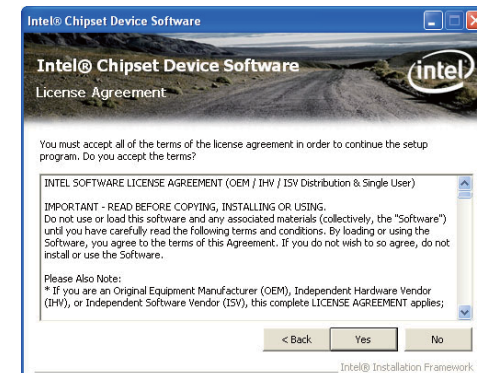

- Go through the readme document for more installation tips then click Next.

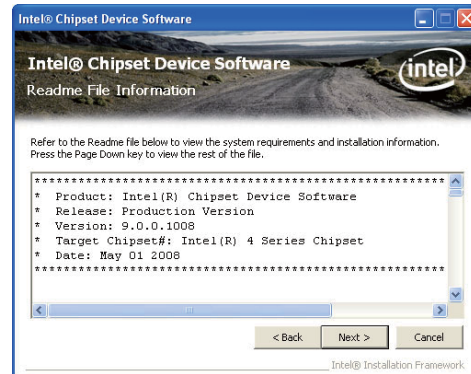

- Click Finish to exit setup.



## Microsoft DirectX 9.0C (For Windows XP)

To install the utility, click “Microsoft DirectX 9.0C Driver” on the main menu.

- Click “I accept the agreement” then click Next.

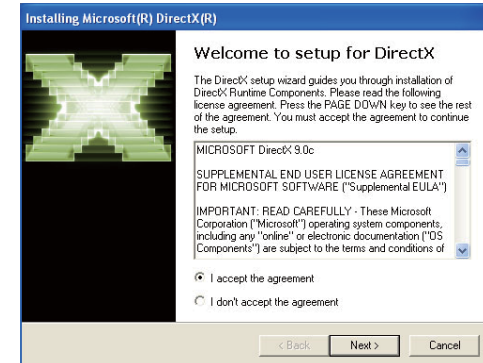

- To start installation, click Next.

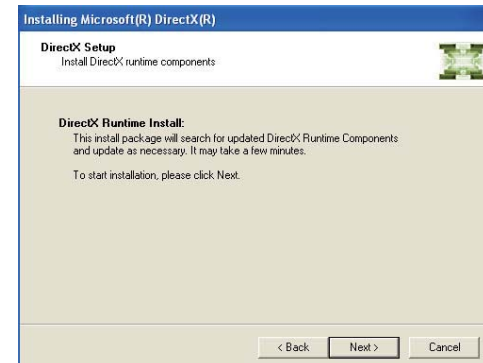

- Click Finish. Reboot the system for DirectX to take effect.

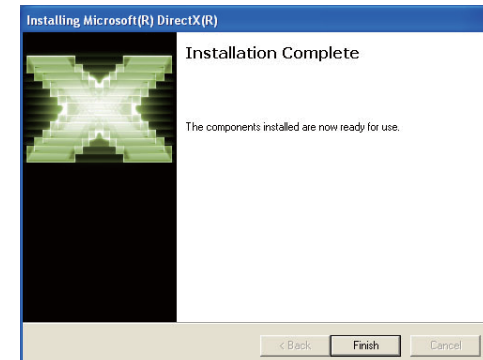

## Intel HD Graphics Drivers (For Windows XP)

To install the driver, click "Intel HD Graphics Drivers" on the main menu.

1. To start installation, click Next.



2. Read the license agreement then click Yes.

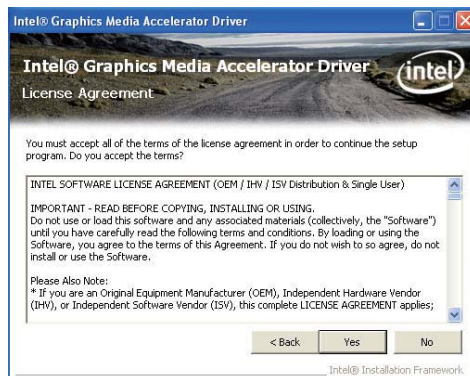

3. Go through the readme document for system requirements and installation tips then click Next.

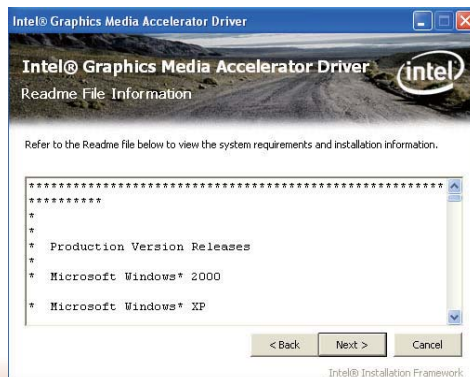

4. Setup is now installing the driver. Click Next to continue.

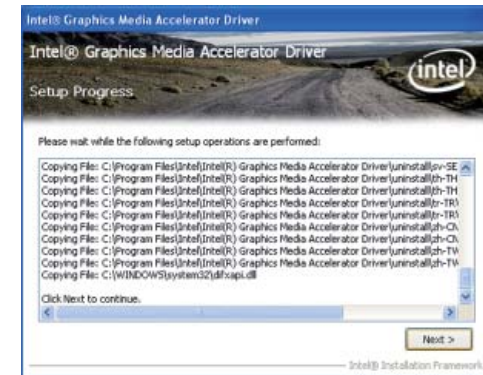

5. Click "Yes, I want to restart this computer now" then click Finish.

Restarting the system will allow the new software installation to take effect.

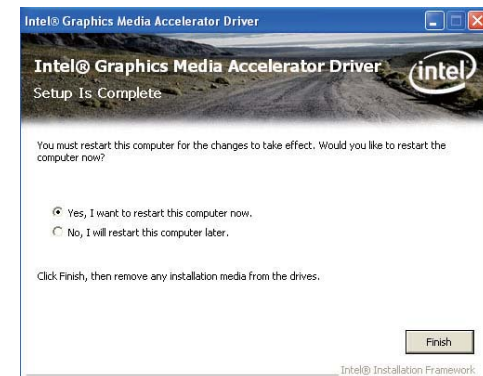

## Intel HD Graphics Drivers (For Windows 7 and Windows 8)

To install the driver, click “Intel HD Graphics Drivers” on the main menu.

1. Setup is now ready to install the graphics driver. Click Next.



By default, the “Automatically run WinSAT and enable the Windows Aero desktop theme” is enabled. With this enabled, after installing the graphics driver and the system rebooted, the screen will turn blank for 1 to 2 minutes (while WinSAT is running) before the Windows Vista desktop appears. The “blank screen” period is the time Windows is testing the graphics performance.

2. Read the license agreement then click Yes.



3. Go through the readme document for system requirements and installation tips then click Next.

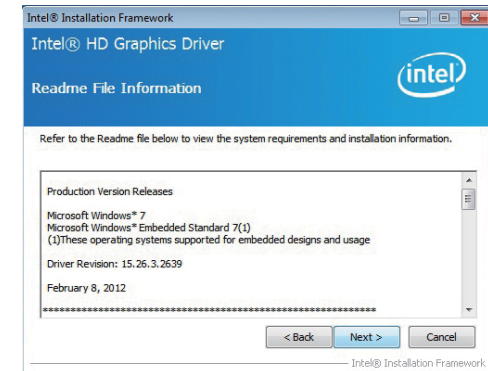

4. Setup is now installing the driver. Click Next to continue.

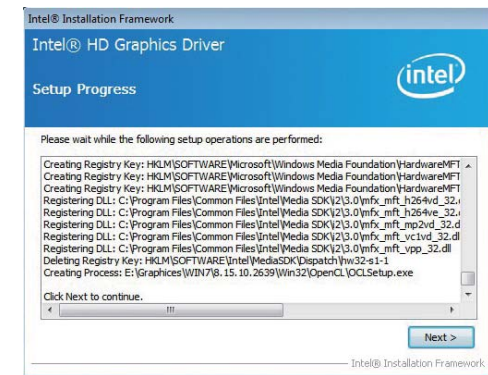

5. Click “Yes, I want to restart this computer now” then click Finish.

Restarting the system will allow the new software installation to take effect.

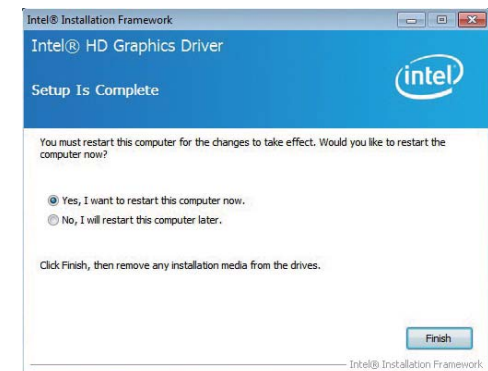

## Intel Management Engine Drivers (For Windows 7 and Windows 8)

To install the driver, click "Intel Management Engine Drivers" on the main menu.

1. Setup is ready to install the driver. Click Next.



2. Read the license agreement then click Yes.

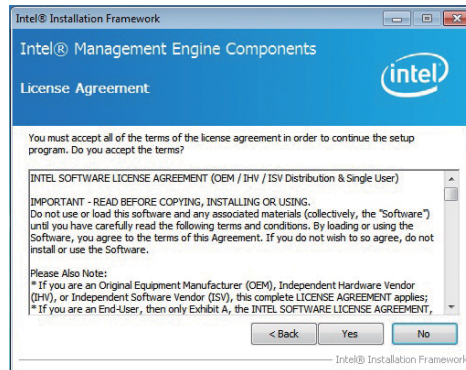

3. Setup is currently installing the driver. After installation has completed, click Next.

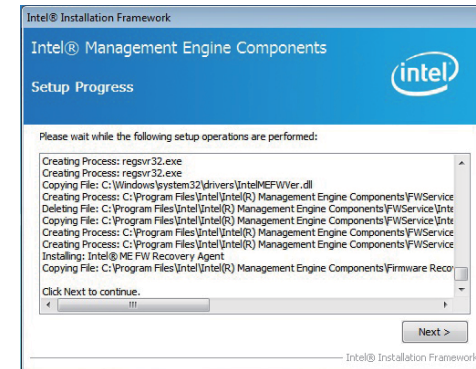

4. After completing installation, click Finish.

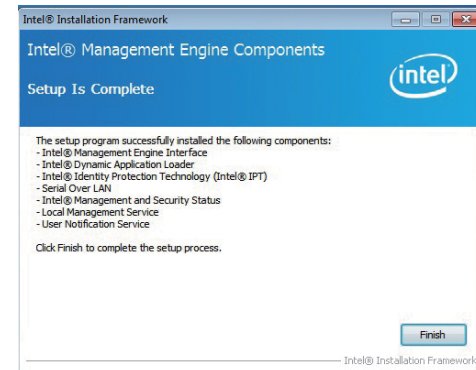

## Audio Drivers

To install the driver, click "Audio Drivers" on the main menu.

1. Setup is ready to install the driver. Click Next.

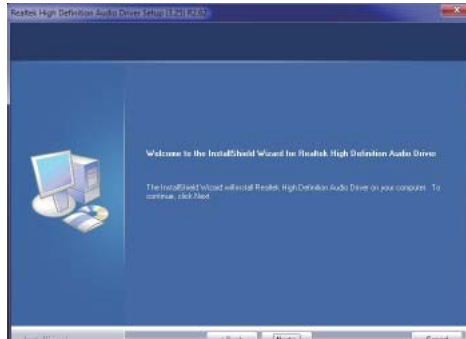

2. Click "Yes, I want to restart my computer now" then click Finish.

Restarting the system will allow the new software installation to take effect.

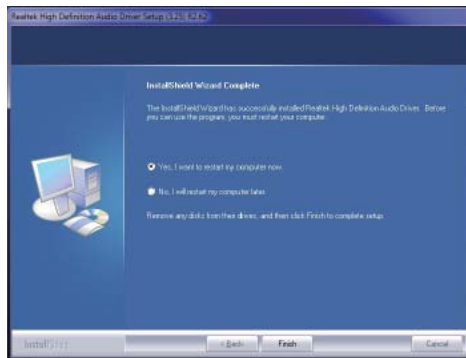

## Intel LAN Drivers (For Windows XP)

The LAN drivers for Windows XP supporting on the Haswell system board has to be installed manually. When you want to install the LAN driver for Windows XP, please follow the steps below to accomplish the installation.

1. Launch the Hardware Update Wizard for the selected device. Select "Update Driver."

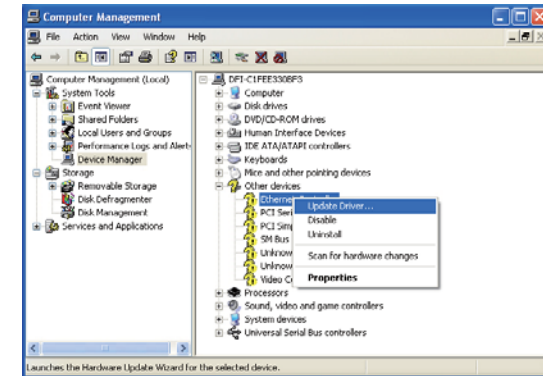

2. Choose "Install from a list or specific location (Advanced)" and click "Next" to continue the installation.

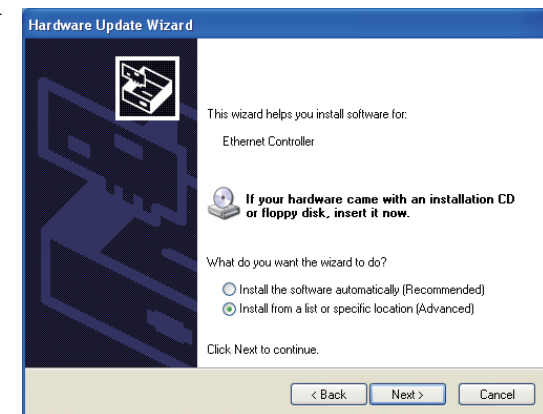

6. Insert the installation disk and make sure the selected drive is correct.

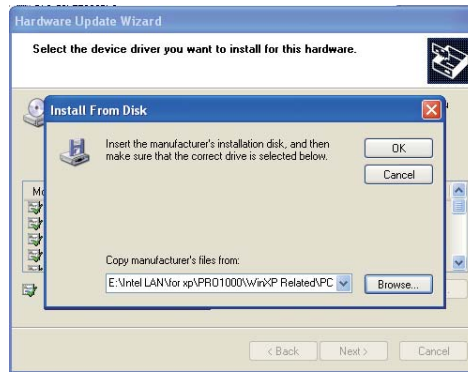

(For 32-bit, the file name is "e1d5132.inf".)

7. Select the device driver you want to install for this hardware and then click "Next."

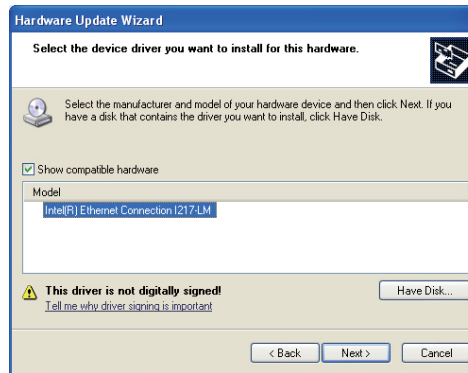

8. Check the software you are installing. Then, click "Continue Anyway" to start the installation.

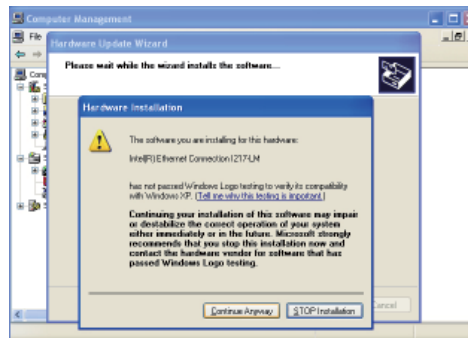

9. Click "Finish" to close the wizard.

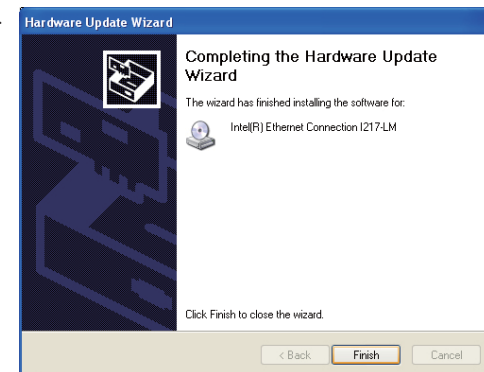

10. After completing the installation, the Network adapters "Intel(R) Ethernet Connection I217LM" will appear on the computer management list.

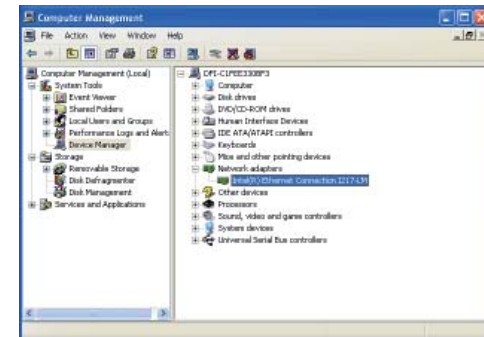

## Intel LAN Drivers (For Windows 7 and Windows 8)

To install the driver, click "Intel LAN Drivers" on the main menu.

1. Setup is ready to install the driver. Click Next.



2. Click "I accept the terms in the license agreement" then click "Next".

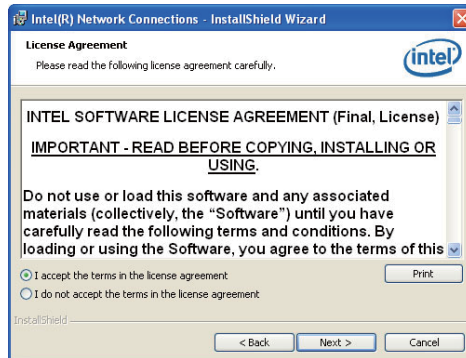

3. Select the program features you want installed then click Next.

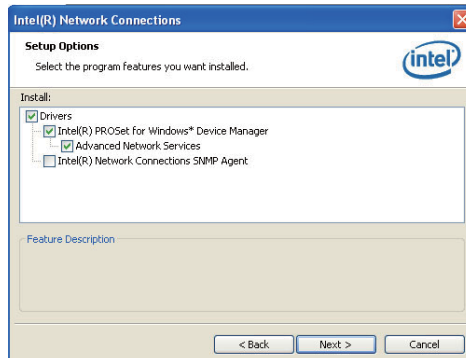

4. Click Install to begin the installation.

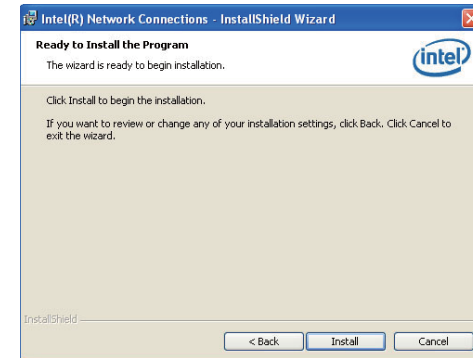

5. After completing installation, click Finish.

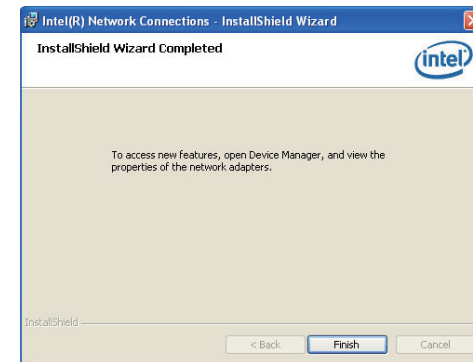



## HW Utility

DFI Utility provides information about the board, Watchdog, and DIO. To access the utility, click "HW Utility" on the main menu.



### Note:

If you are using Windows 7, you need to access the operating system as an administrator to be able to install the utility.

1. Setup is ready to install the DFI Utility driver  
Click "Next".



2. Click "I accept the terms in the license agreement" then click "Next".

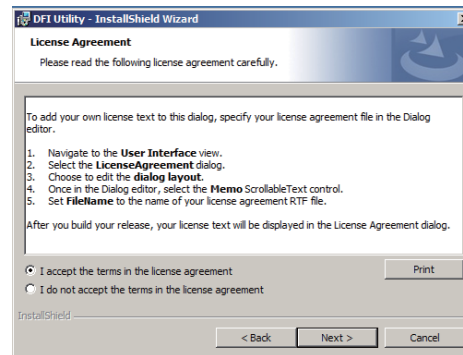

3. Click "Install" to begin the installation.

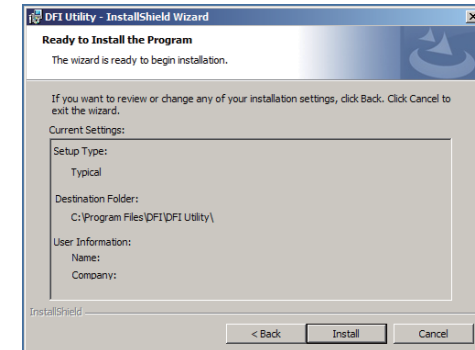

4. After completing installation, click "Finish".

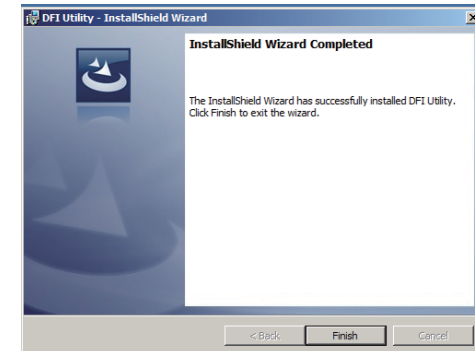

The DFI Utility icon will appear on the desktop. Double-click the icon to open the utility.



Information



HW Health Set



HW Health



WatchDog

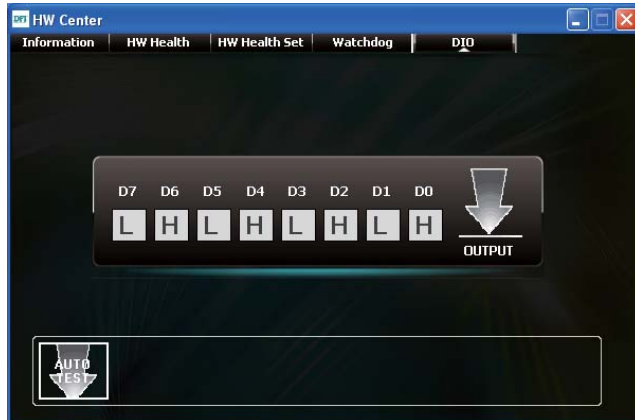

DIO

## Intel USB 3.0 Drivers (For Windows 7)

To install the driver, click "Intel USB 3.0 Driver" on the main menu.

1. Setup is ready to install the driver. Click Next.

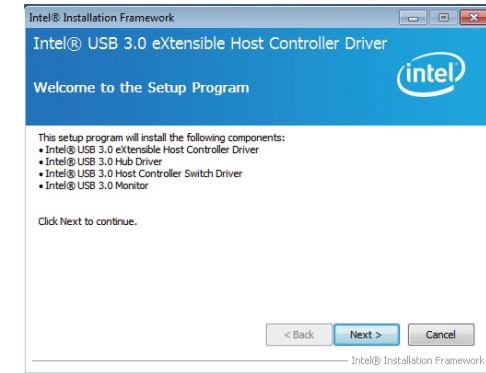

2. Read the license agreement then click Yes.

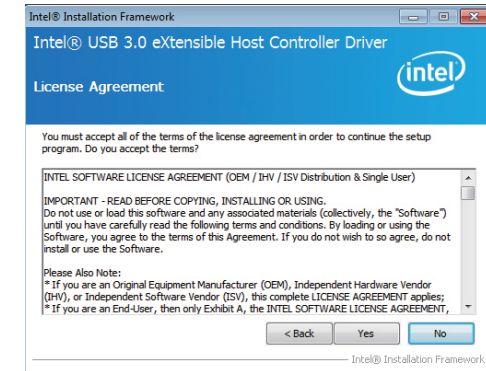

- Go through the readme document for more installation tips then click Next.

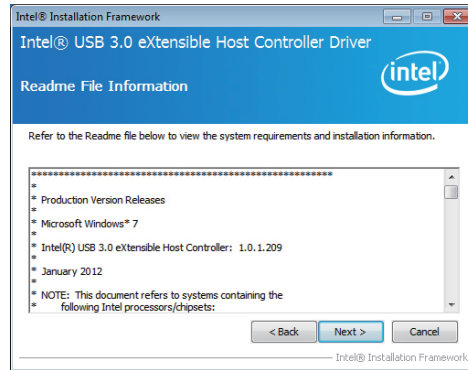

- Setup is currently installing the driver. After installation has completed, click Next.

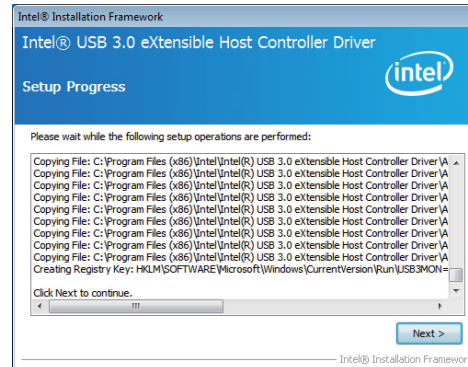

- After completing installation, click Finish.



## Intel USB 3.0 Host Drivers (For Windows 7 and Windows 8)

To install the driver, click “Intel USB 3.0 Host Drivers” on the main menu.

- Click “Intel USB 3.0 Host Drivers” on the main menu to prepare the installation.



- It indicates the setup status.

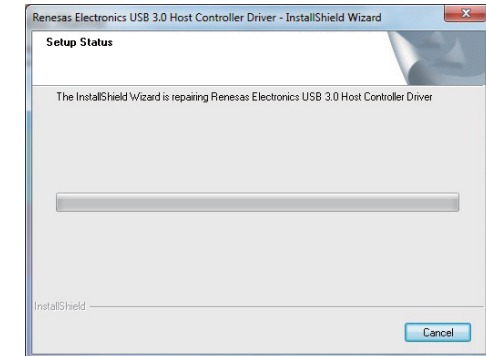

3. Click “finish” to complete the installation.

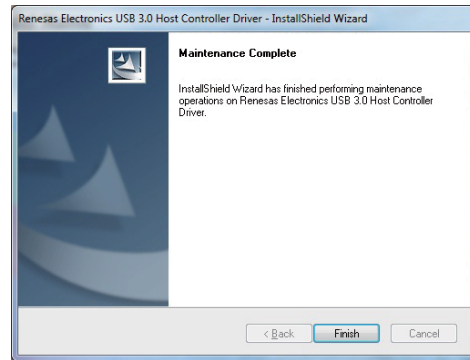

## Intel Rapid Storage Technology (For Windows 7 and Windows 8)

The Intel Rapid Storage Technology is a utility that allows you to monitor the current status of the SATA drives. It enables enhanced performance and power management for the storage subsystem.

To install the driver, click “Intel Rapid Storage Technology” on the main menu.

1. Setup is now ready to install the utility. Click Next.

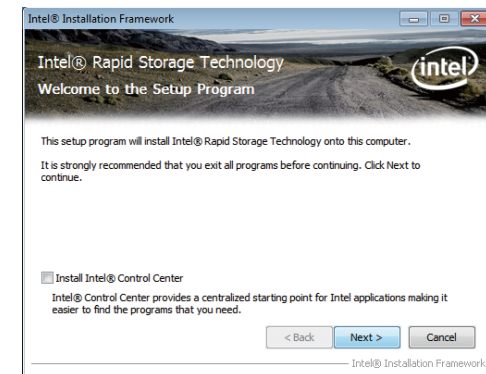

2. Read the warning then click Yes.



3. Read the license agreement then click Yes.

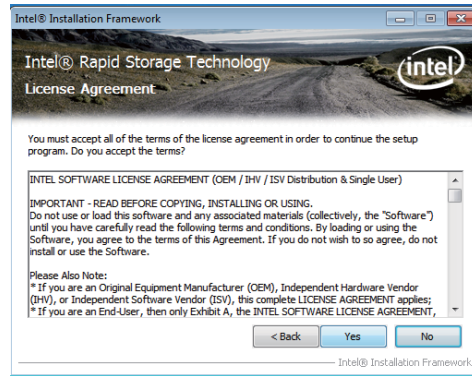

6. Click "Yes, I want to restart my computer now" then click Finish.

Restarting the system will allow the new software installation to take effect.



4. Go through the readme document for system requirements and installation tips then click Next.

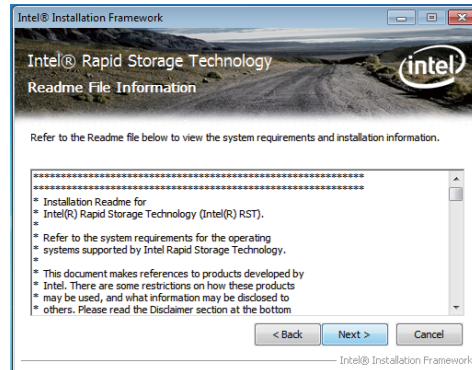

5. Setup is now installing the utility. Click Next to continue.

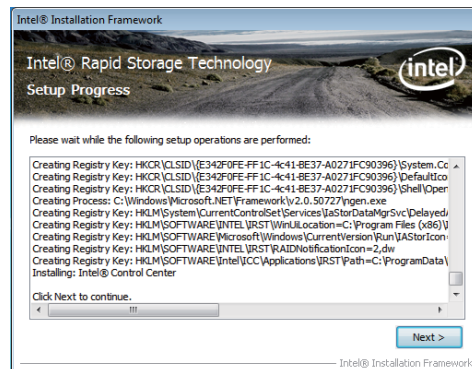

## Infinion TPM Driver and Tool (optional)

To install the driver, click “Infinion TPM driver and tool (option)” on the main menu.

1. The setup program is preparing to install the driver.

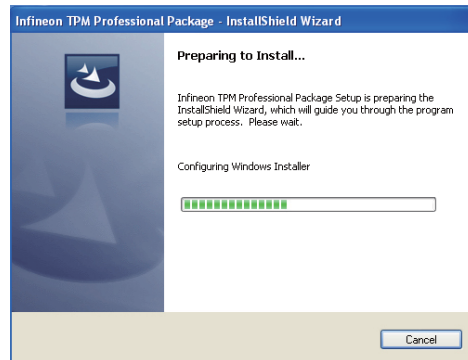

2. The setup program is now ready to install the utility. Click Next.



3. Click “I accept the terms in the license agreement” and then click “Next”.

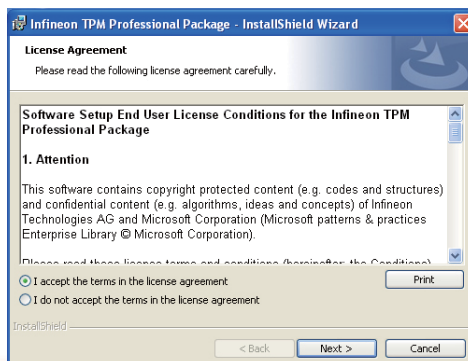

4. Enter the necessary information and then click Next.

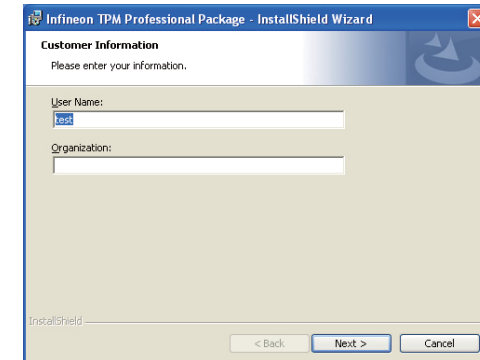

5. Select a setup type and then click Next.

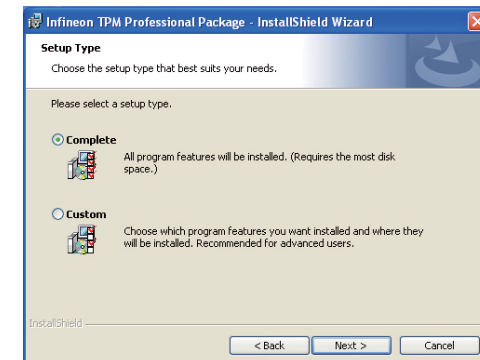

6. Click Install.

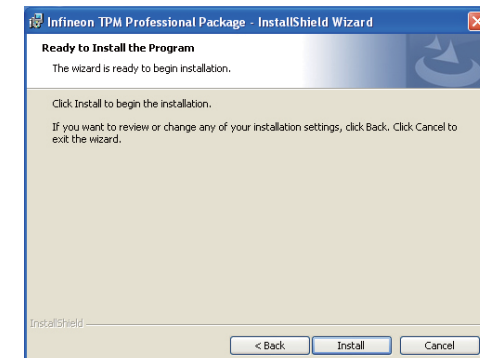

7. TPM requires installing the Microsoft Visual C++ package prior to installing the utility. Click Install.

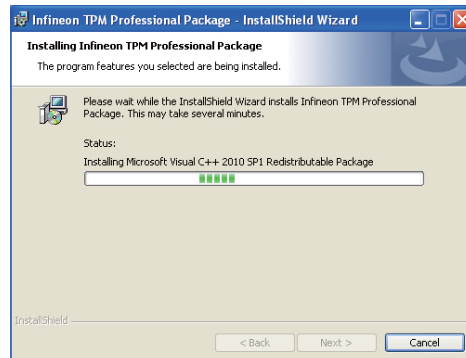

8. The setup program is currently installing the Microsoft Visual C++ package.

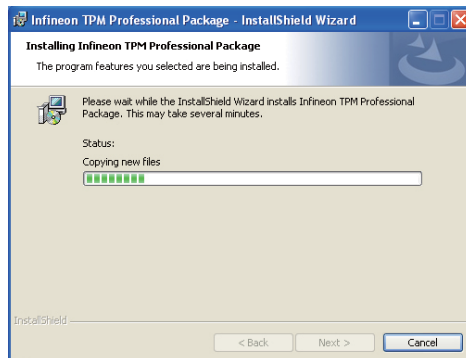

9. Click Finish.



10. Click "Yes" to restart your system.

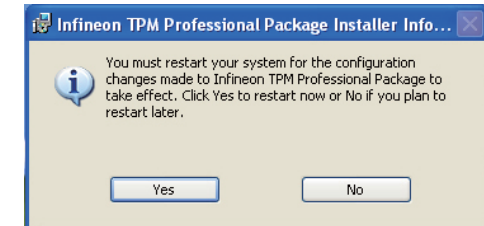



## Nuvton-SIO

To install the driver, click “Nuvton-SIO” on the main menu.

1. The setup program is preparing to install the driver.

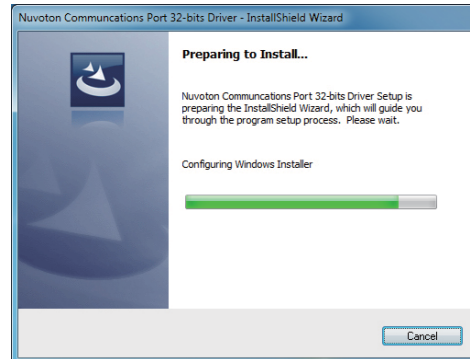

2. The setup program is now ready to install the utility. Click Next.

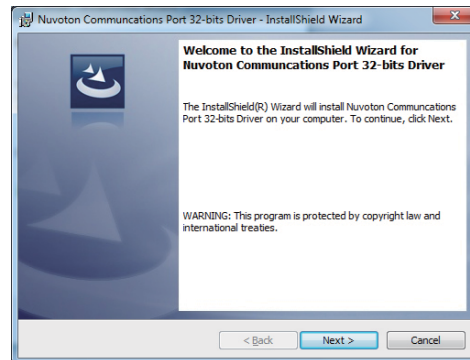

3. Click “Install” to begin the installation.

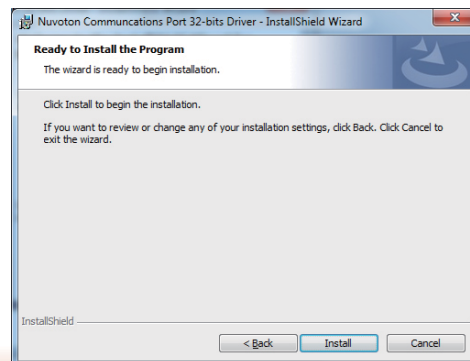

4. Installing status.

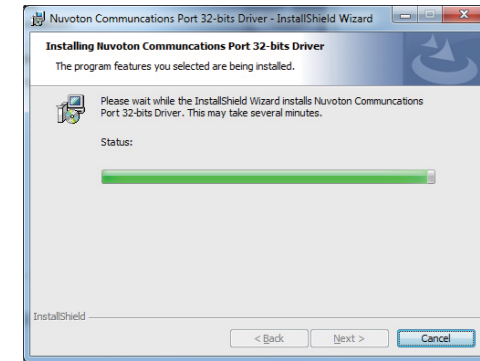

5. Click “Finish” to exit the wizard after the installation is completed.

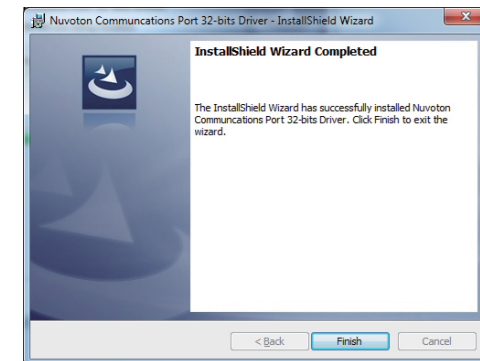

## Adobe Acrobat Reader 9.3

To install the reader, click “Adobe Acrobat Reader 9.3” on the main menu.

1. Click Next to install or click Change Destination Folder to select another folder.

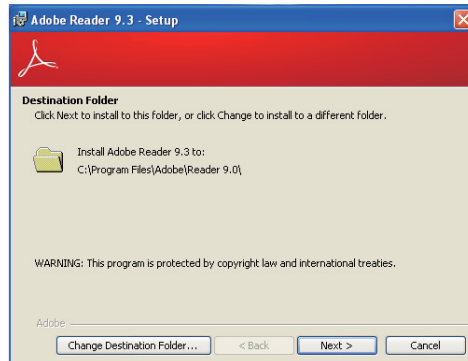

2. Click Install to begin installation.

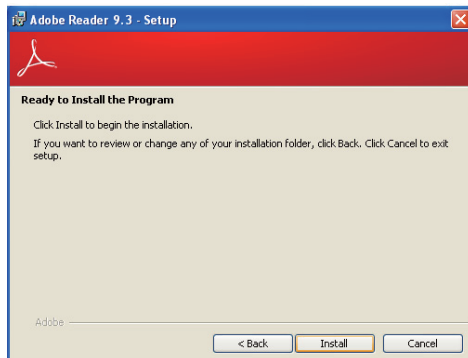

3. Click Finish to exit installation.

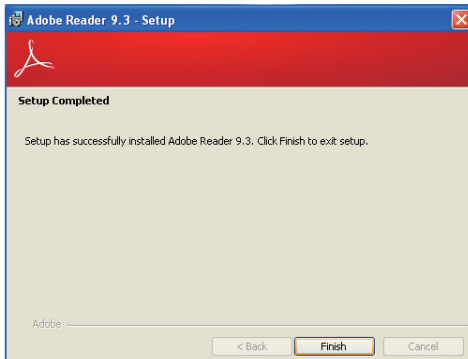

## Chapter 9 - Digital I/O Programming Guide

### Register Description

The Input Port Register (register 0) reflects the incoming logic levels of the pins, regardless of whether the pin is defined as an input or output by the Configuration Register. They act only on the read operation. Writes to this register have no effect. The default value (X) is determined by the externally applied logic level. Before a read operation, a write transmission is sent with the command byte to indicate to the I<sup>2</sup>C device that the Input Port Register will be accessed next.

Register 0 (Input Port Register)

BIT	I-7	I-6	I-5	I-4	I-3	I-2	I-1	I-0
DEFAULT	X	X	X	X	X	X	X	X

The Output Port Register (register 1) shows the outgoing logic levels of the pins defined as outputs by the Configuration Register. Bit values in this register have no effect on pins defined as inputs. In turns, reads from this register reflect the value that is in the flip-flop controlling the output selection, not the actual pin value.

Register 1 (Output Port Register)

BIT	O-7	O-6	O-5	O-4	O-3	O-2	O-1	O-0
DEFAULT	1	1	1	1	1	1	1	1

The Polarity Inversion Register (register 2) allows polarity inversion of the pins defined as inputs by the Configuration Register. If a bit in this register is set (written with 1), the corresponding port pin's polarity is inverted. If a bit in this register is clear (written with a 0), the corresponding port pin's original polarity is retained.

Register 2 (Polarity Inversion Register)

BIT	N-7	N-6	N-5	N-4	N-3	N-2	N-1	N-0
DEFAULT	0	0	0	0	0	0	0	0

The Configuration Register (register 3) configures the direction of the I/O pins. If a bit in this register is set to 1, the corresponding port pin is enabled as an input with a high-impedance output driver. If a bit in this register is cleared to 0, the corresponding port is enabled as an input.

Register 3 (Configuration Register)

BIT	C-7	C-6	C-5	C-4	C-3	C-2	C-1	C-0
DEFAULT	1	1	1	1	1	1	1	1

## Function Description

I2CWriteByte(SlaveAddr, SubAddr, Data):  
Write a Byte data to a specified I2C Device.

I2CReadByte(SlaveAddr, SubAddr, \*Data):  
Read a Byte data from a specified I2C Device.

SetBit(\*Data, Bit) :  
Set Data bit n as "1".

ClrBit(\*Data, Bit) :  
Set Data bit n as "0".

GetBit(Data, Bit) :  
Return the value of data bit n.

## Sample Code

### GPIO Configuration

```
#define SLAVE_ADDR      0x42
#define INPUT_PORT      0x00
#define OUTPUT_PORT     0x01
#define INVERSION_PORT  0x02
#define COMFIG_PORT     0x03

GpioConfig(int PinNum, int Mode)
{
    BYTE Data;
    BYTE TempPinNum = PinNum%8;

    //Pin0-7 Input/Output Configuration
    I2C_ReadByte(SLAVE_ADDR, COMFIG_PORT, &Data);
    if(Mode == 1){SetBit(&Data, TempPinNum);} //Input
    else      {ClrBit(&Data, TempPinNum);} //Output
    I2C_WriteByte(SLAVE_ADDR, COMFIG_PORT, Data);

    return 1;
}
```

### GPIO Output Process

```
#define SLAVE_ADDR      0x42
#define INPUT_PORT      0x00
#define OUTPUT_PORT     0x01
#define INVERSION_PORT  0x02
#define COMFIG_PORT     0x03

GpioOut(int PinNum, int Level)
{
    BYTE Data;
    BYTE TempPinNum = PinNum%8;

    //Pin0-7
    I2C_ReadByte(SLAVE_ADDR, OUTPUT_PORT, &Data);
    if(Level == 0){ClrBit(&Data, TempPinNum);}
    else      {SetBit(&Data, TempPinNum);}
    I2C_WriteByte(SLAVE_ADDR, OUTPUT_PORT, Data);

    return 1;
}
```

### GPIO Input Process

```
#define SLAVE_ADDR      0x42
#define INPUT_PORT      0x00
#define OUTPUT_PORT     0x01
#define INVERSION_PORT  0x02
#define COMFIG_PORT     0x03

GpioIn(int PinNum, int *Status)
{
    BYTE Data;
    BYTE Group = PinNum/8;
    BYTE TempPinNum = PinNum%8;

    //Pin0-7
    I2C_ReadByte(SLAVE_ADDR, INPUT_PORT, &Data);
    *Status = GetBit(Data, TempPinNum);

    return 1;
}
```

## Appendix A - Watchdog Sample Code

---

;Software programming example:

```

;-----
;(1) Enter Super IO Configuration mode
;-----
MOV     DX,4EH
MOV     AL,87H
OUT     DX,AL
OUT     DX,AL

;-----
;(2) Configuration Logical Device 8, register CRF0/CRF1 (WDT Control/WDT
timer)
;-----
MOV     DX,4EH
MOV     AL,07H           ;Ready to Program Logical Device
OUT     DX,AL

MOV     DX,4FH
MOV     AL,08H           ;Select Logical Device 8
OUT     DX,AL

MOV     DX,4EH
MOV     AL, F1H           ;Select watchdog timer register
OUT     DX,AL

MOV     DX,4FH
MOV     AL,10H           ;Set watchdog timer value
OUT     DX,AL

MOV     DX,4EH
MOV     AL, F0H           ;Select watchdog Control Register
OUT     DX,AL

MOV     DX,4FH
MOV     AL,02H           ;Set Watchdog Control Value
OUT     DX,AL

;-----
;(1) Exit extended function mode
;-----
MOV     DX,4EH
MOV     AL,AAH
OUT     DX,AL

```

## Appendix B - System Error Message

When the BIOS encounters an error that requires the user to correct something, either a beep code will sound or a message will be displayed in a box in the middle of the screen and the message, PRESS F1 TO CONTINUE, CTRL-ALT-ESC or DEL TO ENTER SETUP, will be shown in the information box at the bottom. Enter Setup to correct the error.

### Error Messages

One or more of the following messages may be displayed if the BIOS detects an error during the POST. This list indicates the error messages for all Awards BIOSes:

#### CMOS BATTERY HAS FAILED

The CMOS battery is no longer functional. It should be replaced.



#### Important:

Danger of explosion if battery incorrectly replaced. Replace only with the same or equivalent type recommended by the manufacturer. Dispose of used batteries according to the battery manufacturer's instructions.

#### CMOS CHECKSUM ERROR

Checksum of CMOS is incorrect. This can indicate that CMOS has become corrupt. This error may have been caused by a weak battery. Check the battery and replace if necessary.

#### DISPLAY SWITCH IS SET INCORRECTLY

The display switch on the motherboard can be set to either monochrome or color. This indicates the switch is set to a different setting than indicated in Setup. Determine which setting is correct, either turn off the system and change the jumper or enter Setup and change the VIDEO selection.

#### FLOPPY DISK(S) fail (80)

Unable to reset floppy subsystem.

#### FLOPPY DISK(S) fail (40)

Floppy type mismatch.

#### Hard Disk(s) fail (80)

HDD reset failed.

#### Hard Disk(s) fail (40)

HDD controller diagnostics failed.

#### Hard Disk(s) fail (20)

HDD initialization error.

#### Hard Disk(s) fail (10)

Unable to recalibrate fixed disk.

#### Hard Disk(s) fail (08)

Sector Verify failed.

#### Keyboard is locked out - Unlock the key

The BIOS detects that the keyboard is locked. Keyboard controller is pulled low.

#### Keyboard error or no keyboard present

Cannot initialize the keyboard. Make sure the keyboard is attached correctly and no keys are being pressed during the boot.

#### Manufacturing POST loop

System will repeat POST procedure infinitely while the keyboard controller is pull low. This is also used for the M/B burn in test at the factory.

#### BIOS ROM checksum error - System halted

The checksum of ROM address F0000H-FFFFFH is bad.

#### Memory test fail

The BIOS reports memory test fail if the memory has error(s).

## Appendix C - Troubleshooting Checklist

### Troubleshooting Checklist

This chapter of the manual is designed to help you with problems that you may encounter with your personal computer. To efficiently troubleshoot your system, treat each problem individually. This is to ensure an accurate diagnosis of the problem in case a problem has multiple causes.

Some of the most common things to check when you encounter problems while using your system are listed below.

1. The power switch of each peripheral device is turned on.
2. All cables and power cords are tightly connected.
3. The electrical outlet to which your peripheral devices are connected is working. Test the outlet by plugging in a lamp or other electrical device.
4. The monitor is turned on.
5. The display's brightness and contrast controls are adjusted properly.
6. All add-in boards in the expansion slots are seated securely.
7. Any add-in board you have installed is designed for your system and is set up correctly.

### Monitor/Display

#### If the display screen remains dark after the system is turned on:

1. Make sure that the monitor's power switch is on.
2. Check that one end of the monitor's power cord is properly attached to the monitor and the other end is plugged into a working AC outlet. If necessary, try another outlet.
3. Check that the video input cable is properly attached to the monitor and the system's display adapter.
4. Adjust the brightness of the display by turning the monitor's brightness control knob.

#### The picture seems to be constantly moving.

1. The monitor has lost its vertical sync. Adjust the monitor's vertical sync.
2. Move away any objects, such as another monitor or fan, that may be creating a magnetic field around the display.
3. Make sure your video card's output frequencies are supported by this monitor.

#### The screen seems to be constantly wavering.

1. If the monitor is close to another monitor, the adjacent monitor may need to be turned off. Fluorescent lights adjacent to the monitor may also cause screen wavering.

### Power Supply

#### When the computer is turned on, nothing happens.

1. Check that one end of the AC power cord is plugged into a live outlet and the other end properly plugged into the back of the system.
2. Make sure that the voltage selection switch on the back panel is set for the correct type of voltage you are using.
3. The power cord may have a "short" or "open". Inspect the cord and install a new one if necessary.

### Floppy Drive

#### The computer cannot access the floppy drive.

1. The floppy diskette may not be formatted. Format the diskette and try again.
2. The diskette may be write-protected. Use a diskette that is not write-protected.
3. You may be writing to the wrong drive. Check the path statement to make sure you are writing to the targeted drive.
4. There is not enough space left on the diskette. Use another diskette with adequate storage space.

## Hard Drive

### Hard disk failure.

1. Make sure the correct drive type for the hard disk drive has been entered in the BIOS.
2. If the system is configured with two hard drives, make sure the bootable (first) hard drive is configured as Master and the second hard drive is configured as Slave. The master hard drive must have an active/bootable partition.

### Excessively long formatting period.

If your hard drive takes an excessively long period of time to format, it is likely a cable connection problem. However, if your hard drive has a large capacity, it will take a longer time to format.

## Serial Port

### The serial device (modem, printer) doesn't output anything or is outputting garbled characters.

1. Make sure that the serial device's power is turned on and that the device is on-line.
2. Verify that the device is plugged into the correct serial port on the rear of the computer.
3. Verify that the attached serial device works by attaching it to a serial port that is working and configured correctly. If the serial device does not work, either the cable or the serial device has a problem. If the serial device works, the problem may be due to the onboard I/O or the address setting.
4. Make sure the COM settings and I/O address are configured correctly.

## Keyboard

### Nothing happens when a key on the keyboard was pressed.

1. Make sure the keyboard is properly connected.
2. Make sure there are no objects resting on the keyboard and that no keys are pressed during the booting process.

## System Board

1. Make sure the add-in card is seated securely in the expansion slot. If the add-in card is loose, power off the system, re-install the card and power up the system.
2. Check the jumper settings to ensure that the jumpers are properly set.
3. Verify that all memory modules are seated securely into the memory sockets.
4. Make sure the memory modules are in the correct locations.
5. If the board fails to function, place the board on a flat surface and seat all socketed components. Gently press each component into the socket.
6. If you made changes to the BIOS settings, re-enter setup and load the BIOS defaults.