



GM330-BFF

Gaming Computing System

User's Manual

Copyright

This publication contains information that is protected by copyright. No part of it may be reproduced in any form or by any means or used to make any transformation/adaptation without the prior written permission from the copyright holders.

This publication is provided for informational purposes only. The manufacturer makes no representations or warranties with respect to the contents or use of this manual and specifically disclaims any express or implied warranties of merchantability or fitness for any particular purpose. The user will assume the entire risk of the use or the results of the use of this document. Further, the manufacturer reserves the right to revise this publication and make changes to its contents at any time, without obligation to notify any person or entity of such revisions or changes.

Changes after the publication's first release will be based on the product's revision. The website will always provide the most updated information.

© 2019. All Rights Reserved.

Trademarks

Product names or trademarks appearing in this manual are for identification purpose only and are the properties of the respective owners.

FCC and DOC Statement on Class B

This equipment has been tested and found to comply with the limits for a Class B digital device, pursuant to Part 15 of the FCC rules. These limits are designed to provide reasonable protection against harmful interference when the equipment is operated in a residential installation. This equipment generates, uses and can radiate radio frequency energy and, if not installed and used in accordance with the instruction manual, may cause harmful interference to radio communications. However, there is no guarantee that interference will not occur in a particular installation. If this equipment does cause harmful interference to radio or television reception, which can be determined by turning the equipment off and on, the user is encouraged to try to correct the interference by one or more of the following measures:

- Reorient or relocate the receiving antenna.
- Increase the separation between the equipment and the receiver.
- Connect the equipment into an outlet on a circuit different from that to which the receiver is connected.
- Consult the dealer or an experienced radio TV technician for help.

Notice:

1. The changes or modifications not expressly approved by the party responsible for compliance could void the user's authority to operate the equipment.
2. Shielded interface cables must be used in order to comply with the emission limits.

Table of Contents

About this Manual.....	4	Chapter 4 - Jumper Settings.....	14
Warranty	4	Clear CMOS Data.....	14
Static Electricity Precautions	4	FPGA Programming Mode Select.....	14
Safety Measures.....	4	MCU Programming Mode.....	15
Safety Precautions	5	Chapter 5 - Ports and Connectors.....	16
About the Package.....	5	Audio Ports.....	16
Before Using the System	5	USB Ports.....	17
Chapter 1 - Introduction.....	6	DC-in.....	17
Overview.....	6	COM Ports.....	18
Key Features	6	RJ45 LAN Ports	19
Specifications.....	7	Intrusion Door	19
Getting to Know the GM330-BFF	8	Display Outputs	20
Mechanical Dimensions	9	Digital Inputs/outputs.....	20
Chapter 3 - Installing Devices.....	11	I/O Connectors	22
Connecting the I/O Board	11	Expansion Connectors.....	22
Powering on the System and Connecting the Display.....	11	CPU Fan Connector.....	22
Removing the Chassis Cover.....	12	LEDs.....	23
Installing a SODIMM.....	12	Battery	23
Installing an M.2 card	13	Chapter 6 - Mounting.....	26
Installing a SATA DOM	13	Chapter 7 - BIOS Setup	27
		Chapter 8 - Supported Software	38

About this Manual

An electronic file of this manual can be obtained from the DFI website at www.dfi.com. To download the user's manual from our website, please go to Support > Download Center. On the Download Center page, select your product or type the model name and click "Search" to find all technical documents including the user's manual for a specific product.

Warranty

1. Warranty does not cover damages or failures that arised from misuse of the product, inability to use the product, unauthorized replacement or alteration of components and product specifications.
2. The warranty is void if the product has been subjected to physical abuse, improper instalation, modification, accidents or unauthorized repair of the product.
3. Unless otherwise instructed in this user's manual, the user may not, under any circumstances, attempt to perform service, adjustments or repairs on the product, whether in or out of warranty. It must be returned to the purchase point, factory or authorized service agency for all such work.
4. We will not be liable for any indirect, special, incidental or consequential damages to the product that has been modified or altered.

Static Electricity Precautions

It is easy to inadvertently damage your PC, system board, components or devices even before installing them in your system unit. Static electrical discharge can damage computer components without causing any signs of physical damage. You must take extra care in handling them to ensure against electrostatic build-up.

1. To prevent electrostatic build-up, leave the system board in its anti-static bag until you are ready to install it.
2. Wear an antistatic wrist strap.
3. Do all preparation work on a static-free surface.
4. Hold the device only by its edges. Be careful not to touch any of the components, contacts or connections.
5. Avoid touching the pins or contacts on all modules and connectors. Hold modules or connectors by their ends.

Important:

Electrostatic discharge (ESD) can damage your processor, disk drive and other components. Perform the upgrade instruction procedures described at an ESD workstation only. If such a station is not available, you can provide some ESD protection by wearing an antistatic wrist strap and attaching it to a metal part of the system chassis. If a wrist strap is unavailable, establish and maintain contact with the system chassis throughout any procedures requiring ESD protection.

Safety Measures

To avoid damage to the system:

- Use the correct AC input voltage range.

To reduce the risk of electric shock:

- Unplug the power cord before removing the system chassis cover for installation or servicing. After installation or servicing, cover the system chassis before plugging the power cord.

Battery:

- Danger of explosion if battery incorrectly replaced.
- Replace only with the same or equivalent type recommend by the manufacturer.
- Dispose of used batteries according to local ordinance.

Safety Precautions

- Use the correct DC input voltage range.
- Unplug the power cord before removing the system chassis cover for installation or servicing. After installation or servicing, cover the system chassis before plugging the power cord.
- Danger of explosion if battery incorrectly replaced.
- Replace only with the same or equivalent type recommend by the manufacturer.
- Dispose of used batteries according to local ordinance.
- Keep this system away from humidity.
- Place the system on a stable surface. Dropping it or letting it fall may cause damage.
- The openings on the system are for air ventilation to protect the system from overheating. **DO NOT COVER THE OPENINGS.**
- Place the power cord in such a way that it will not be stepped on. Do not place anything on top of the power cord. Use a power cord that has been approved for use with the system and that it matches the voltage and current marked on the system's electrical range label.
- If the system will not be used for a long time, disconnect it from the power source to avoid damage by transient overvoltage.
- If one of the following occurs, consult a service personnel:
 - The power cord or plug is damaged.
 - Liquid has penetrated the system.
 - The system has been exposed to moisture.
 - The system is not working properly.
 - The system dropped or is damaged.
 - The system has obvious signs of breakage.
- The unit uses a three-wire ground cable which is equipped with a third pin to ground the unit and prevent electric shock. Do not defeat the purpose of this pin. If your outlet does not support this kind of plug, contact your electrician to replace the outlet.
- Disconnect the system from the DC outlet before cleaning. Use a damp cloth. Do not use liquid or spray detergents for cleaning.

About the Package

The package contains the following items. If any of these items are missing or damaged, please contact your dealer or sales representative for assistance.

- GM330-BFF system unit
- Mounting screws for M.2 modules
- CD disk includes
 - Manual
 - Drivers
- Quick Installation Guide

The board and accessories in the package may not come similar to the information listed above. This may differ in accordance to the sales region or models in which it was sold. For more information about the standard package in your region, please contact your dealer or sales representative.

Before Using the System

Before powering-on the system, prepare the basic system components.

If you are installing the system for the first time, you will need at least one of the following internal components.

- Storage devices such as SATA DOMs and M.2 modules.

You will also need external system peripherals, which will normally include at least a keyboard, a mouse and a video display.

Chapter 1 - Introduction

Overview

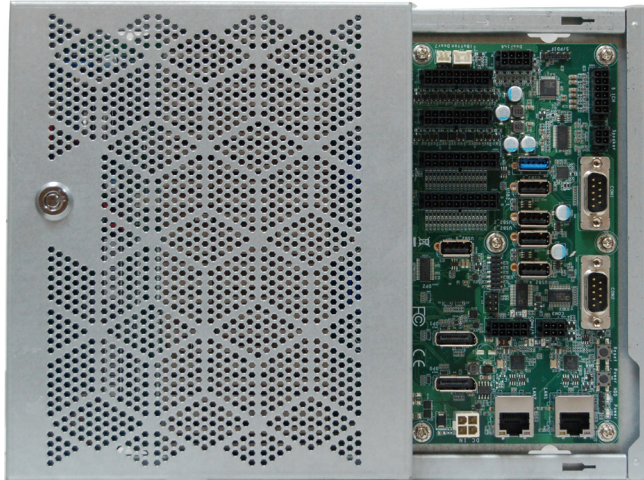

Key Features

Model Name	GM330-BFF
Processor	AMD Embedded G-Series I ,J and JX Family SoCs
Audio	Speaker and 5.1 Channel Audio Output S/PDIF Digital Output
LAN	Two LAN ports
COM	One RS-232 (DB-9 connector) One RS-232/422/485 (DB-9 connector) One RS-232 (Tx, Rx)/ccTalk (pin headers) Two RS-232 (Tx, Rx)/SAS/BACTA (pin headers)
Display	Two DP++
USB	Two USB 3.0 and five USB 2.0 Type A ports

Specifications

Processor System	AMD® GX-217GI, Dual Core, 1MB Cache, 4 CU, 1.7GHz (2.0GHz), 12-15W AMD® GX-224IJ, Dual Core, 1MB Cache, 3 CU, 2.4GHz (2.8GHz), 10-15W AMD® GX-220IJ, Dual Core, 1MB Cache, 2 CU, 2.0GHz (2.2GHz), 10-15W
Memory	<ul style="list-style-type: none"> One 260-pin SODIMM up to 32GB (Dual Channel DDR4 3200MHz) Two 260-pin SODIMM for AMD® GX-217GI only
Graphics	<ul style="list-style-type: none"> AMD® Radeon™ R6E graphics for GX-217GI (up to 4 CUs) AMD® Radeon™ graphics for GX-224IJ (up to 3 CUs) & GX-220IJ (up to 2 CUs) Supported codecs: OpenGL 4.2, DirectX 12, OpenCL 1.2 HW Decode: AVC/H.264, MPEG2, VC1/WMV9, JPEG/MJPEG, HEVC/H265, VP8, VP9 HW Encode: MPEG2, AVC/H264, JPEG, HEVC/H265, VP8, VP9 Display interfaces: 2 x DP++ (DP: resolution up to 3840x2160 @ 60Hz)
Audio	5.1 Channel Audio Output S/PDIF Digital Output Stereo 10W+10W Class D Audio AMP Output
Storage/Expansion	<ul style="list-style-type: none"> 2 x SATA 3.0 (up to 6GB/s) with 7-pin VCC Support (plus a 5V DC-out connector) 1 x M.2 M Key (2280, PCIe x4)
Ethernet	2 x Realtek 8119 or 8111HN (optional) Gigabit Ethernet Controller
I/O Ports and LED Indicators	<ul style="list-style-type: none"> LEDs <ul style="list-style-type: none"> 1 x Power LED 1 x HDD LED I/O Ports <ul style="list-style-type: none"> 1 x RS-232 (DB-9 connector) 1 x RS-232/422/485 (DB-9 connector) 1 x RS-232 (Tx, Rx)/ccTalk (pin header) 2 x RS-232 (Tx, Rx)/SAS/BACTA (pin header) 2 x USB 3.0 5 x USB 2.0 Digital I/O <ul style="list-style-type: none"> DI: 1~32 DO: 1~32 OC output (29-bit x 500mA, support 8 meter with disconnect detection; 3-bit x 3A) Intrusion detection doors: 1~8 Button <ul style="list-style-type: none"> Power Button Reset Button

Power	• 12V DC-in (4-pin Vertical Connector)
Environment	<ul style="list-style-type: none"> Temperature <ul style="list-style-type: none"> - Operating: 0°C ~ 45°C - Storage: -20°C ~ 85°C Relative Humidity <ul style="list-style-type: none"> - 5 to 90% RH (non-condensing)
Vibration	<ul style="list-style-type: none"> Operation: IEC 60068-2-64 Test Fh: Vibration Board-Band Random Test Random, 1Grms @ 5~500 Hz, 30min. Non-Operation: IEC 60068-2-6 Test Fc: Vibration Sinusoidal Test Sweep sine, 3Grms @ 10~500Hz, 30min.
Shock	<ul style="list-style-type: none"> Operation: IEC 60068-2-27 Test Ea: Shock test Half-sine, 3G @ 11ms, 18 Shock ±X, ±Y, ±Z (each axis 3 times) Non-Operation: IEC 60068-2-27 Test Ea: Shock test Half-sine, 5G @ 11ms, 18 Shock ±X, ±Y, ±Z (each axis 3 times)
Security	TPM 1.2/2.0
Construction	• Aluminum + Metal Aluminum
Mounting	• Wall mount (*)
Dimensions (W x H x D)	• 270mm x 63mm x 200mm (10.63" x 2.48" x 7.87")
Weight	• TBD
OS Support	Windows 7/10 (64-bit) Ubuntu 16.04 LTS (64-bit)



Note:

*The mount kit is not supported in the standard model. Please contact your sales representative for more information.

Getting to Know the GM330-BFF

Front View

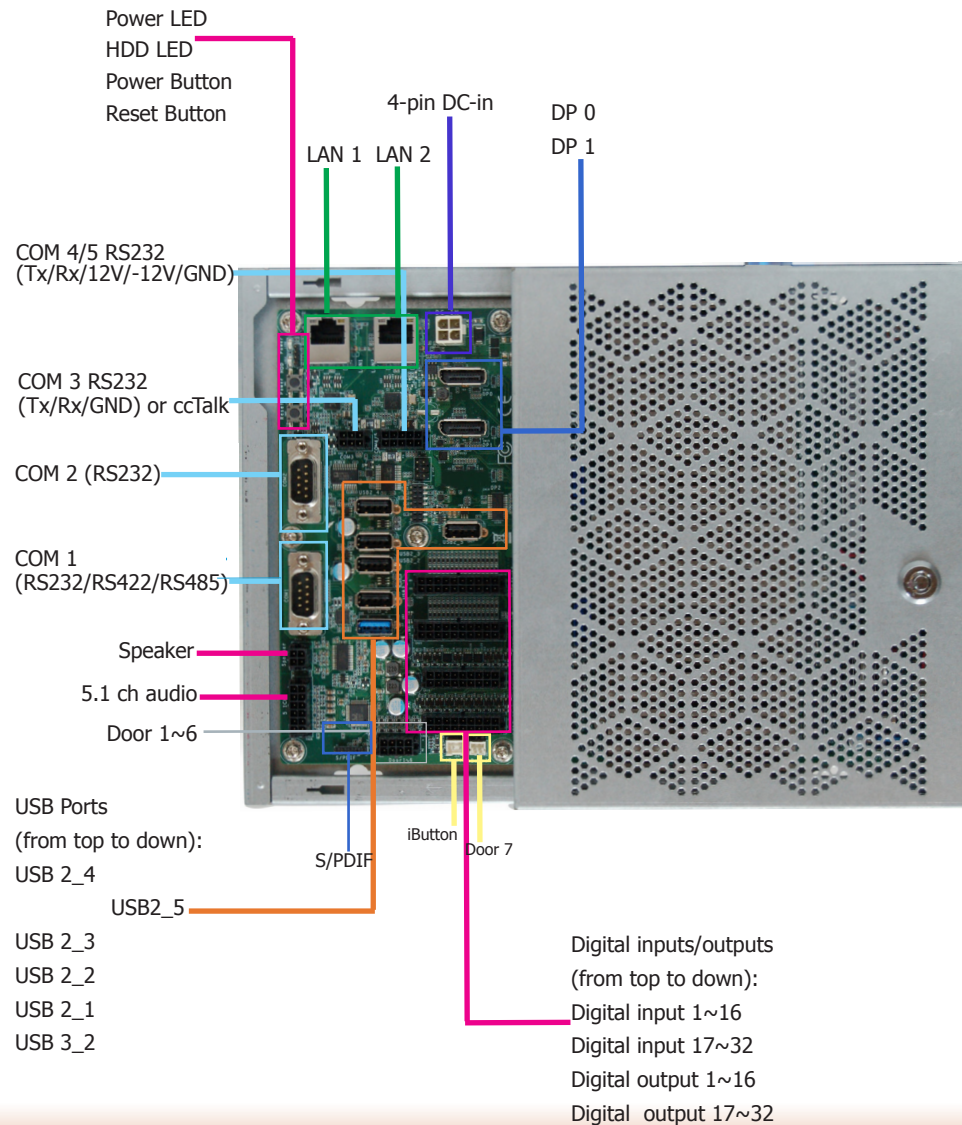

Speaker and 5.1 ch audio

Connects an audio I/O module to the 4-pin speaker connector for stereo (4.5W+4.5W) speakers and 5.1 ch audio connector for audio sound systems; there is also an S/PDIF digital audio connector.

Digital I/O

32 digital inputs via 2x10 micro-fit connector
32 digital outputs via 2x9 micro-fit connector

LAN Ports

Connect the system to a local area network.

DC-in

DC 12V power input via a 4-pin connector.

DP Ports (DP 0&1)

Connect the DisplayPort of a display device.

USB 2.0 & 3.0 Ports

5 USB 2.0 ports and 2 USB 3.0 ports (one in the I/O area and the other in the system area protected by a cover)

COM ports

COM1 (DB-9): connects RS232/RS422/RS485 devices.

COM2 (DB-9): connects RS232 devices.

COM3: connects RS232 with Tx/Rx/GND or ccTalk

COM4/5: connects RS232 with Tx/Rx/+12V/-12V/GND

Power LED

Indicates the status of the system.

HDD LED

Indicates the status of the storage device.

Power Button

Press to power on or off the system.

Reset Button

Press to reset the system.

Intrusion Doors Connectors

6 doors via a 2x4 micro-fit connector

1 door via a 2-pin box header in the I/O area

1 door via a 2-pin box header in the protected system area

Mechanical Dimensions

Chassis Dimension

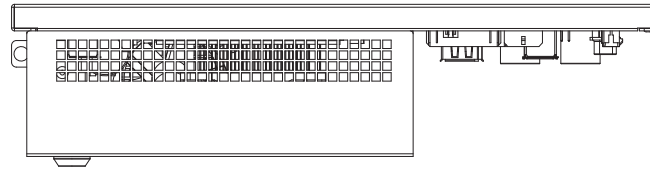

Front View

Left View

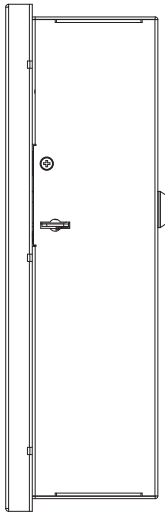

Right View

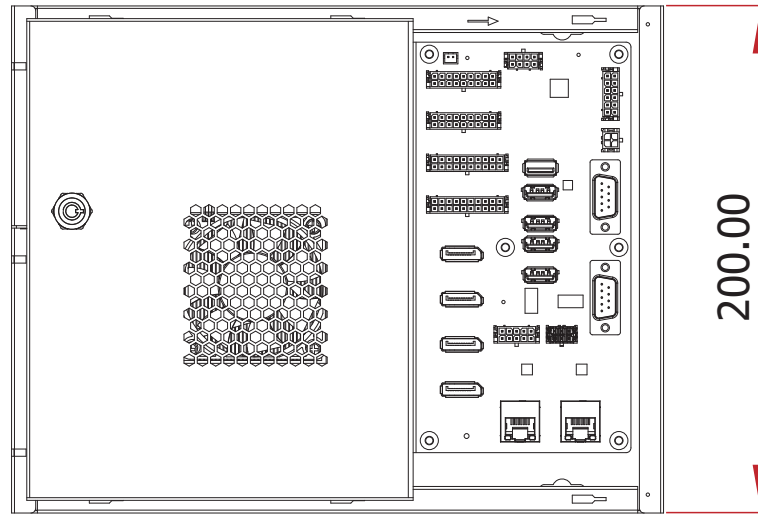
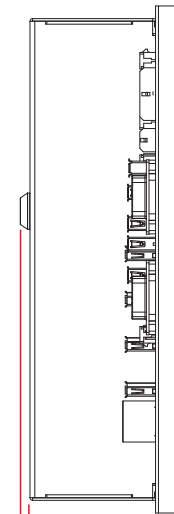

Top View

200.00

63.00

67.00

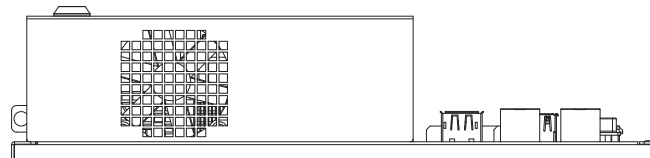

Rear View

Chapter 2 - Getting Started

Preparing the System

Before you start using the system, you need the following items:

- SATA DOMs or M.2 modules
- USB keyboard
- USB mouse
- CD-ROM drive (for installing software/drivers)
- Screwdriver
- Memory modules

Installing Devices

The following devices can be installed in the system.

- Memory modules
- SATA DOMs
- M.2 modules

Configuring the BIOS

To get you started, you may need to change configurations such as the date, time and the priority of boot devices.

1. Power on the system.
2. After the memory test, the message "Press DEL to run setup" will appear on the screen. Press the Delete key to enter the BIOS setup utility.

Installing an Operating System

Most operating system software can be installed using a DVD (and DVD burner) or bootable USB drive.

Please refer to your operating system manual for instructions on installing an operating system.

Installing the Drivers

The system comes with a software package including drivers. These drivers must be installed to provide the best system performance. Refer to the Supported Software Chapter for instructions on installing drivers.

Chapter 3 - Installing Devices

Connecting the I/O Board

The system supports 32 digital inputs and outputs. The I/O board that came with the package can be connected to the system to test the digital input and output function. Please observe the following guidelines and follow the procedure to connect the I/O board.

1. Make sure the system and all other peripheral devices connected to it have been powered off.
2. Disconnect all power cords and cables.
3. Connect one end of the USB cable (type-A connector) to the system and the other end of the USB cable (type-B connector) to the I/O board.
4. Connect the I/O board to the system's intrusion detection connector (labeled door 1~6) using the red cable.
5. Connect the I/O board to the system's DIO port (labeled DO: 17~32) using the blue cable.
6. Connect the I/O board to the system's DIO port (labeled DO: 1~16) using the green cable.
7. Connect the I/O board to the system's DIO port (labeled DI: 17~32) using the yellow cable.
8. Connect the I/O board to the system's DIO port (labeled DI: 1~16) using the orange cable.

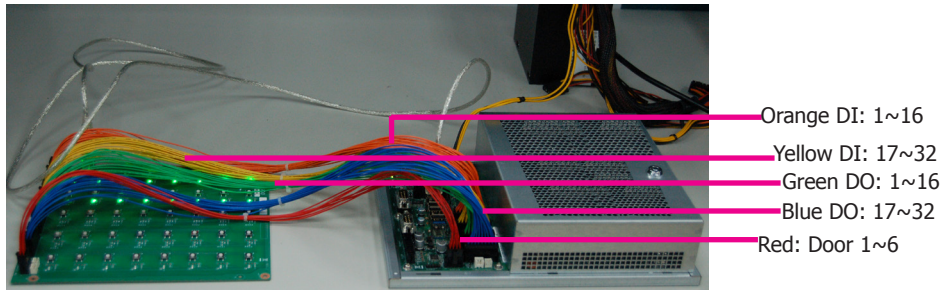

Note:

The tact buttons on the I/O board can be used to invoke a door intrusion event or set the high/low level of a digital I/O port. You can also use the demonstration application to alter a digital I/O port's level. For more information, please refer to the software application guide.

Powering on the System and Connecting the Display

To power on the system, simply connect the 4-pin power cable to the system and the system will be automatically powered on. If you want to use a power or a reset switch (tact button), they are located on the system board as shown in the following picture.

To connect the display, use a DisplayPort cable to connect one of the DP ports to a display device.

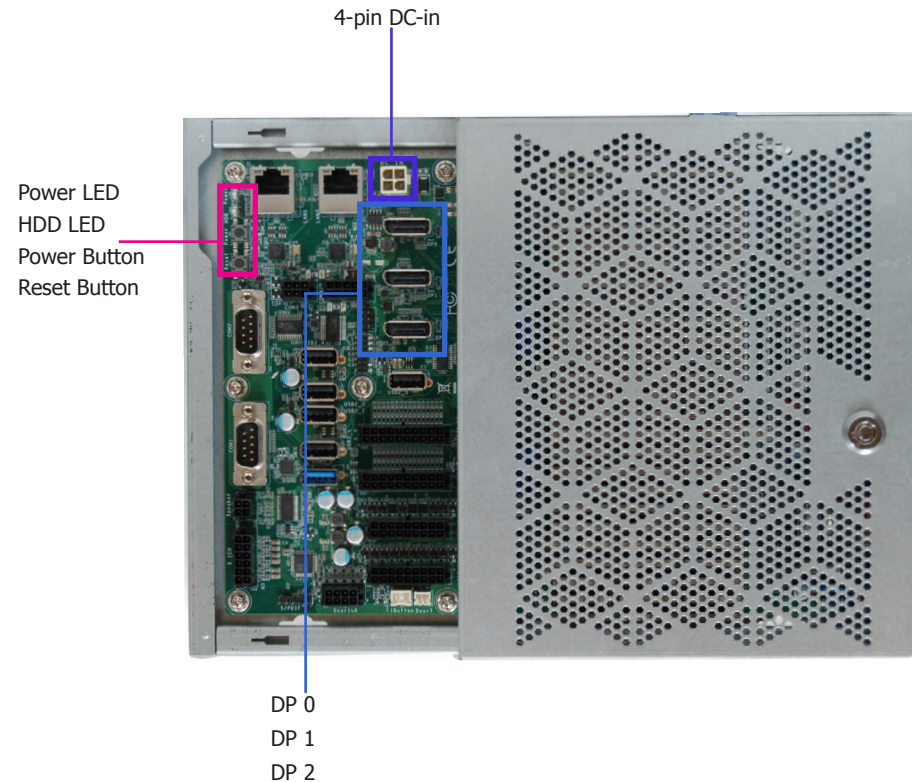

Removing the Chassis Cover

Please observe the following guidelines before opening the chassis cover:

1. Make sure the system and all other peripherals connected to it have been powered off.
2. Disconnect all power cords and cables.
3. The mounting screw on the rear side of the system compartment is used to secure the cover to the chassis. Remove this screw and put it in a safe place for later use.
4. Use the key (push it down slightly and turn it counterclockwise) to unlock the system compartment cover.
5. Slide the cover backward to open the chassis cover.

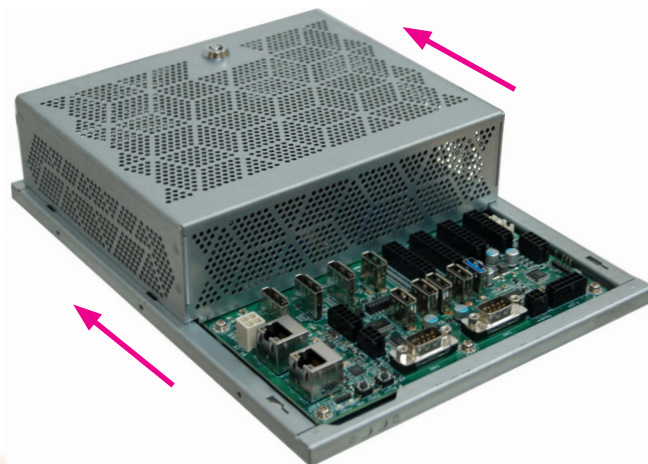
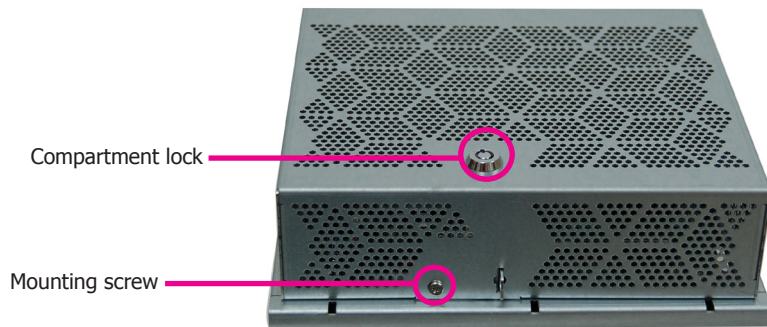

Installing a SODIMM

The system supports two DDR4 SODIMM sockets.

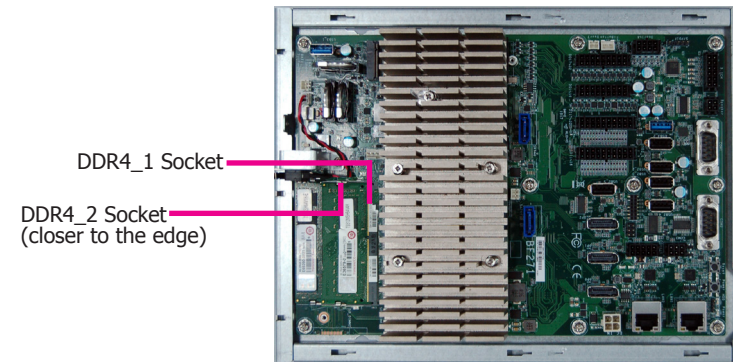

To install a memory module:

1. Grasp the memory module by its edges and align the module's notch with the socket's notch.

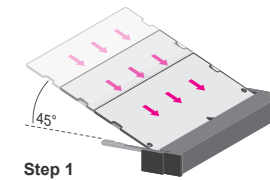

2. 3. Insert the memory into the socket at an angle, and then push it down until you feel a click.

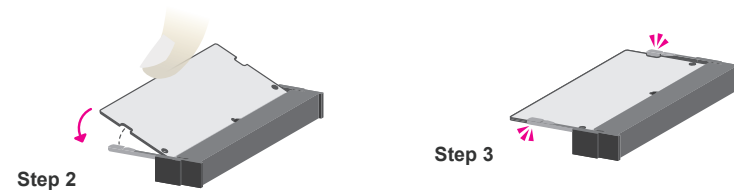

Notes:

1. The system supports dual-channel configuration with the AMD® GX-217GI processor. To enable dual channel, populate both SODIMM sockets.
2. The SODIMM sockets can only accept DDR4 (3200MHz) memory modules. Please do not install other types of memory modules.

Installing an M.2 card

The system has one M.2 type 2280 socket (M Key), which provides PCIe NVMe x4 interface that supports the installation of an M.2 22 x 80mm SSD card. Please note that you need to remove the CPU heatsink.

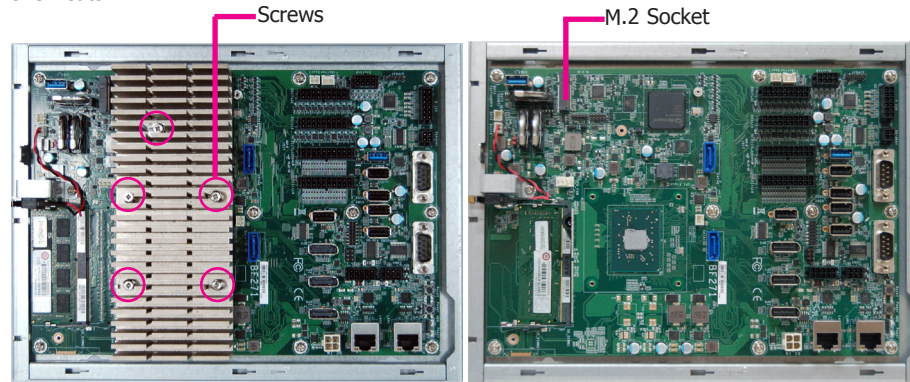

To install an M.2 card:

1. Align the notch at the edge of the M.2 card with the key in the connector and insert the bottom edge of the M.2 card into the connector.

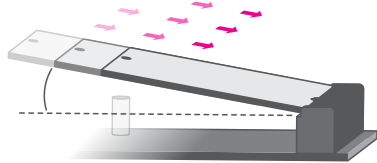

Step 1

2. Insert the bottom edge of the M.2 card into the connector and push down on the other end of the card and use the provided mounting screw to secure the card on the system board.

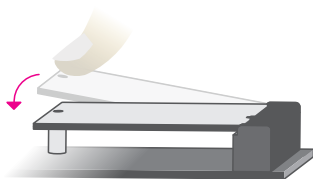

Step 2

3. Push down on the other end of the card and use the provided mounting screw to secure the card on the system board.

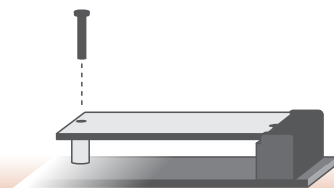

Step 3

Installing a SATA DOM

The system board is equipped with two SATA 3.0 ports that support the installation of SATA DOMs that can be used as a boot drive, system backup and recovery device, etc.

These SATA ports provide power so external power supply is not needed (however, there is an 5V DC-out power connector next to SATA port 0 in case your SATA DOM requires an external power connector). Align the SATA port with the connector of a SATA DOM before inserting the SATA DOM.

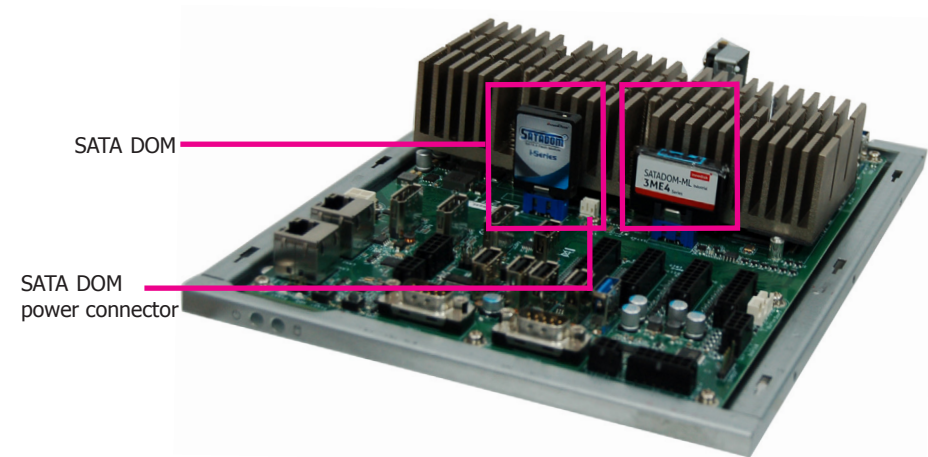

Chapter 4 - Jumper Settings

Clear CMOS Data

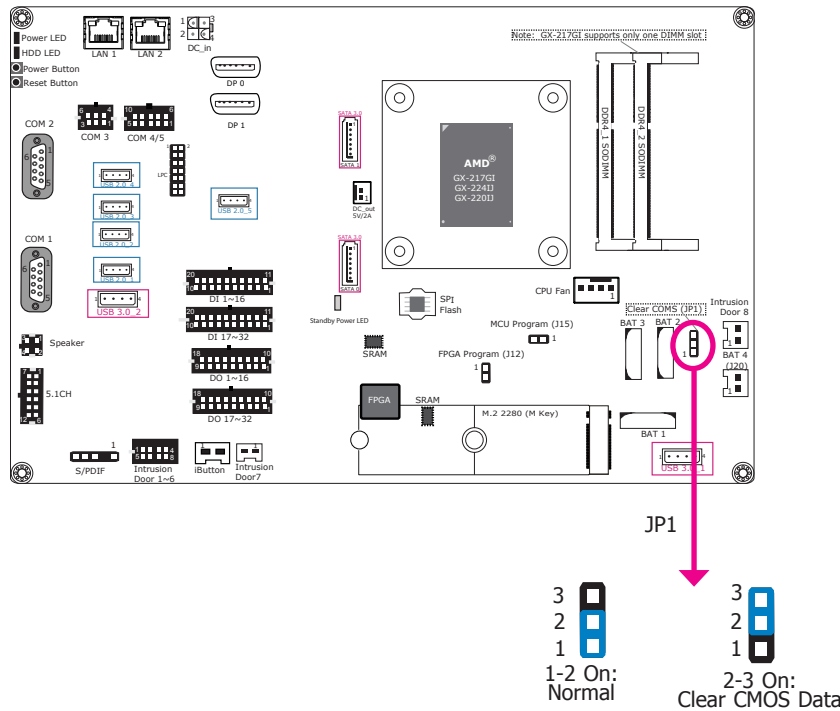

FPGA Programming Mode Select

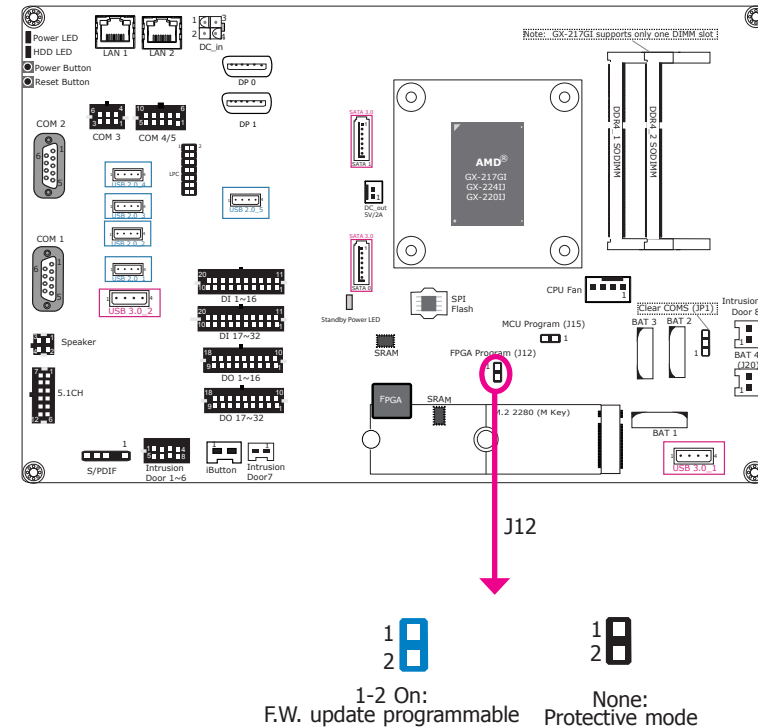

If you encounter the following situations, you can reconfigure the system with the default values stored in the ROM BIOS.

- CMOS data becomes corrupted.
- You forgot the supervisor or user password.

To load the default values stored in the ROM BIOS, please follow the steps below.

- Power-off the system and unplug the power cord.
- Set the jumper pins 2 and 3 to On. Wait for a few seconds and set the jumper back to its default setting, pins 1 and 2 On.
- Now plug the power cord and power-on the system.

J12 is used to select the FPGA programming mode. To enable or disable FPGA programming of the system board, please set the jumper as indicated above.

MCU Programming Mode

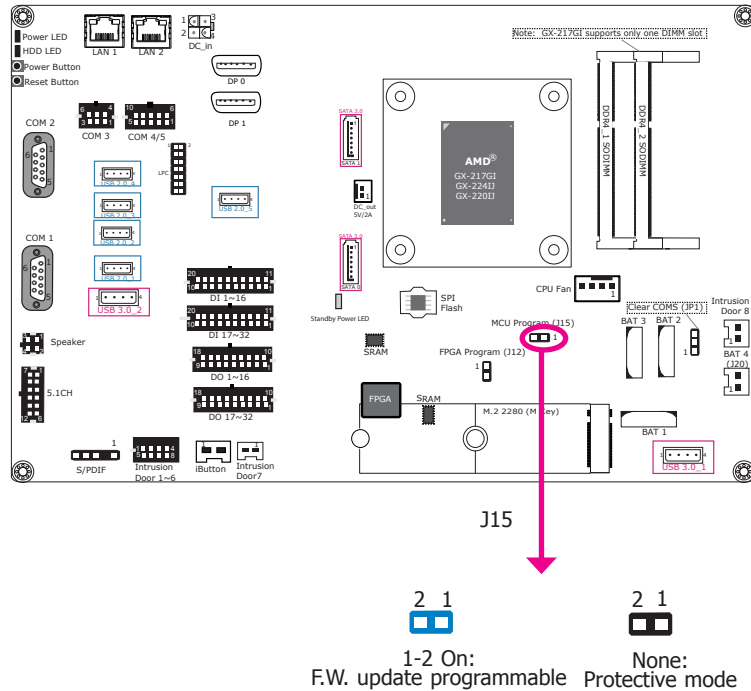

J15 is used to select the MCU programming mode. To enable or disable MCU programming of the system board, please set the jumper as indicated above.

Chapter 5 - Ports and Connectors

Audio Ports

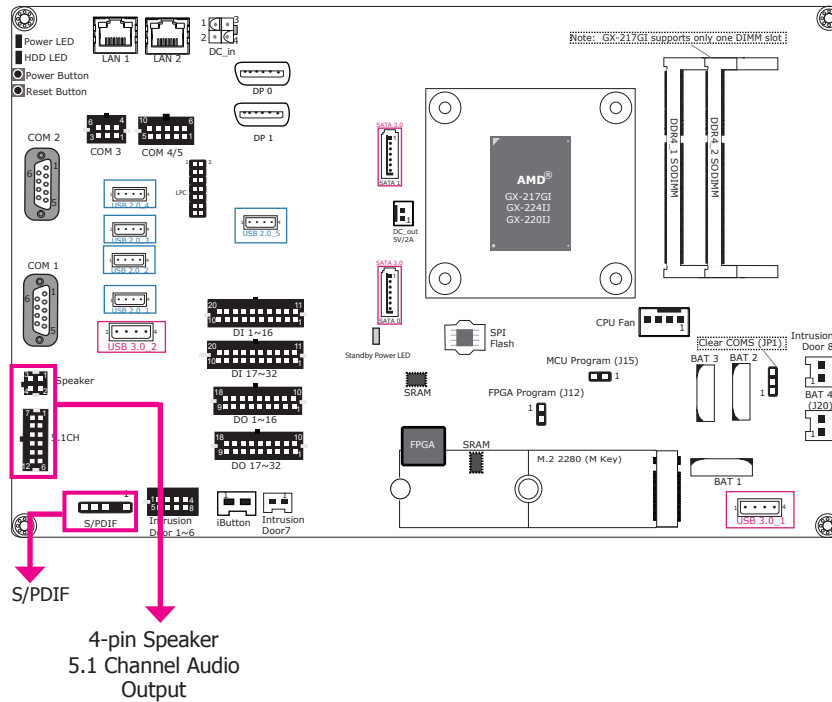

These audio connectors include a 5.1CH audio output and a stereo (10W + 10W) speaker output as well as the digital audio interconnect with the S/PDIF connector. The audio codes are provided by Realtek ALC888S.

• Driver Installation

You may need to install audio driver in your operating system to use audio devices. Refer to Chapter 8 and your operating system's documentation for more information.

5.1 ch Audio

Pins	Pin Assignment	Pins	Pin Assignment
1	LINEOUT-L	7	LINEOUT-R
2	GND	8	GND
3	CENOUT-L	9	LFEOUT-R
4	GND	10	GND
5	SIDEOUT-L	11	SIDEOUT-R
6	GND	12	GND

S/PDIF

Pins	Pin Assignment
1	+5V
2	Key
3	SPDIF out
4	GND
5	NC

4-pin Speaker

Pins	Pin Assignment
1	R-CH+
2	L-CH+
3	R-CH-
4	L-CH-

USB Ports

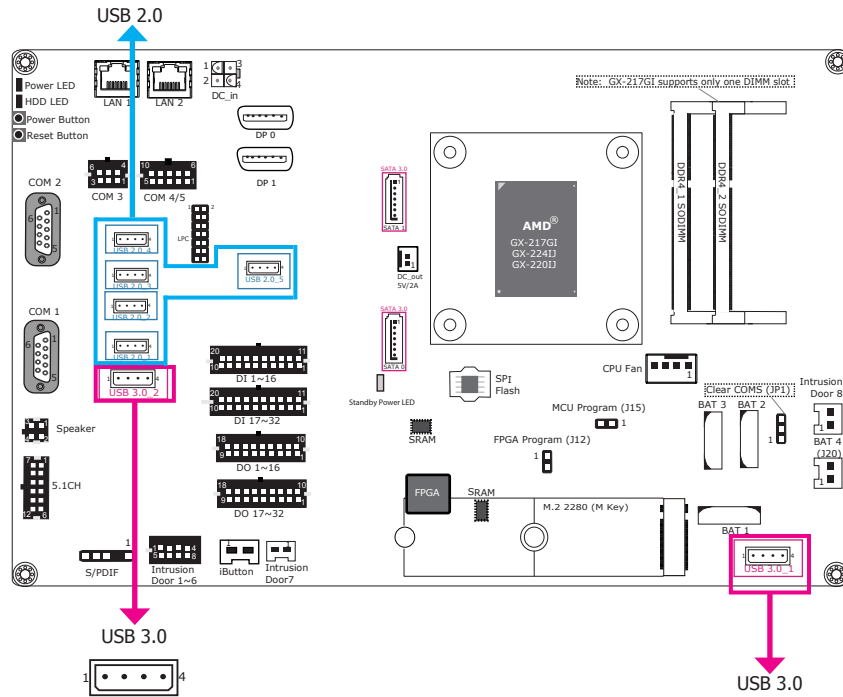

The USB devices allow data exchange between your system and a wide range of simultaneously accessible external Plug and Play peripherals.

The system board is equipped with two USB 3.0 and five USB 2.0 type A vertical ports.

• BIOS Setting

Configure the USB ports in the Advanced menu ("USB Configuration" submenu) of the BIOS. Refer to Chapter 7 for more information.

DC-in

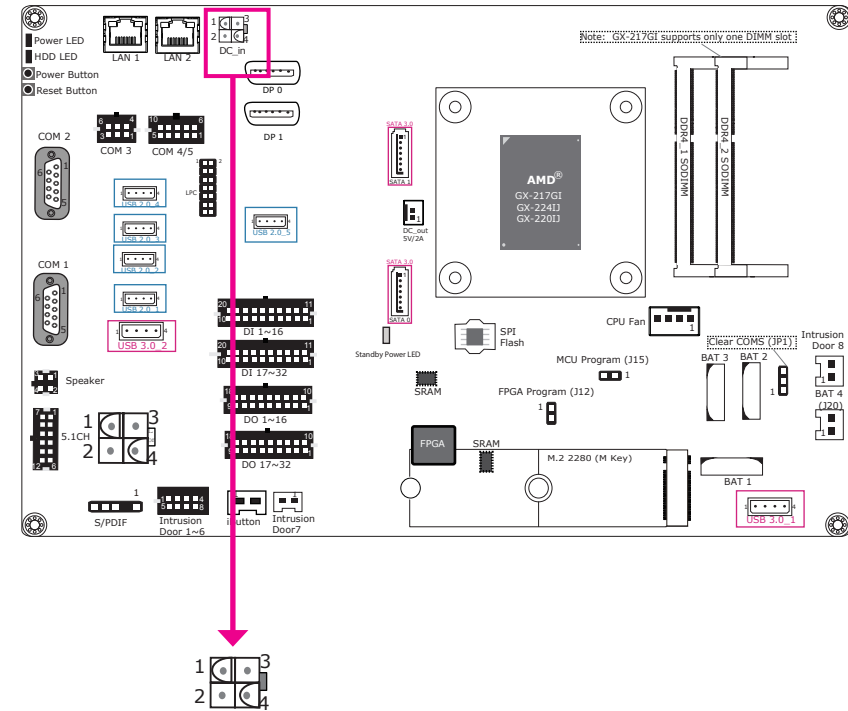

The 4-pin vertical DC-in connector provides a low power input solution. Please use a power adapter with 12V DC output voltage. Using an adapter not compliant to this specification may fail to boot the system or cause damage to the system board.

Pins	Pin Assignment	Pins	Pin Assignment
1	GND 1	3	12V1
2	GND 2	4	12V2

COM Ports

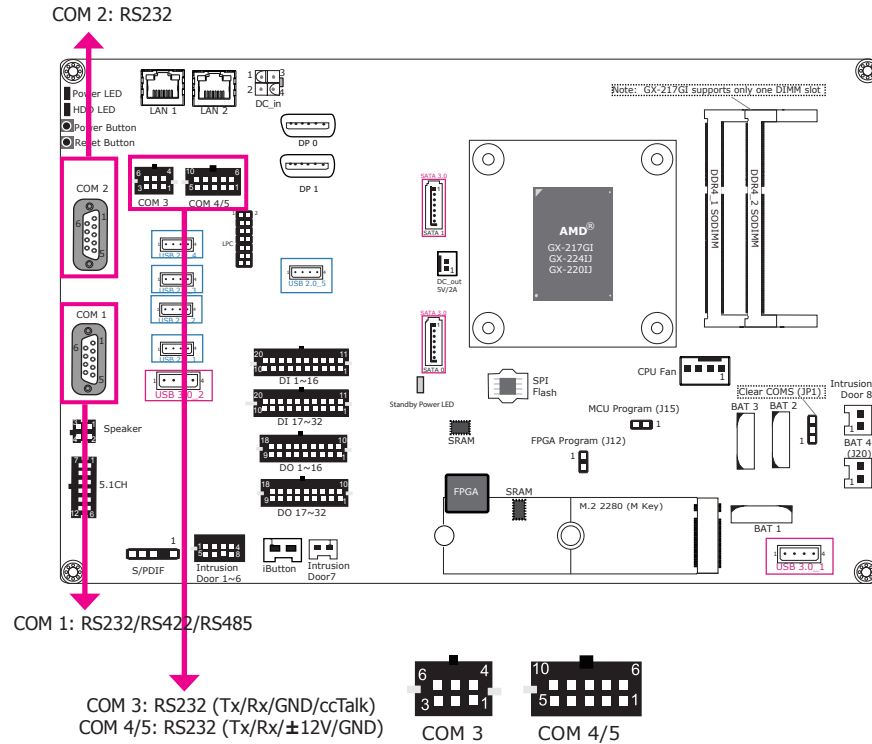

COM 1 and COM 3 can be selected among different communication modes whereas COM 2 can be used in RS232 mode only. COM 3 and COM 4/5 are pin headers and provide signals that are different from typical RS232 communication.

Serial Port

The serial port is an asynchronous communication ports that can be used with modems, serial printers, remote display terminals, and other serial devices. And the ccTalk protocol of COM 3 can be used to connect peripherals used in automatic payment machines for a variety of market sectors such as transportation, ticketing, gaming and entertainment, and retail.

BIOS Setting

Configure the COM ports including its communication mode in the Advanced menu ("Super IO Configuration" submenu) of the BIOS. Refer to Chapter 7 for more information.

COM 1 (RS232/RS422/RS485) / COM 2 (RS232)

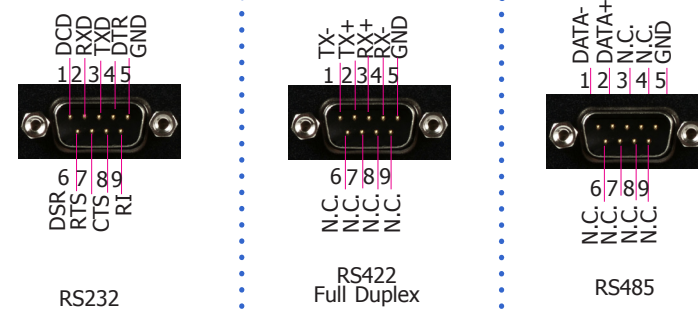

COM 3: RS232 (TX/RX/GND/ccTalk)

Pins	Pin Assignment
1	COM3 RS232-TX
2	COM3 RS232-RX
3	GND
4	+12V power out
5	ccTalk
6	GND

COM 4/5: RS232 (TX/RX/±12V/GND)

Pins	Pin Assignment
1	COM4 RS232-TX
2	COM4 RS232-RX
3	+12V power out
4	-12V power out
5	GND
6	COM5 RS232-TX
7	COM5 RS232-RX
8	+12V power out
9	-12V power out
10	GND

RJ45 LAN Ports

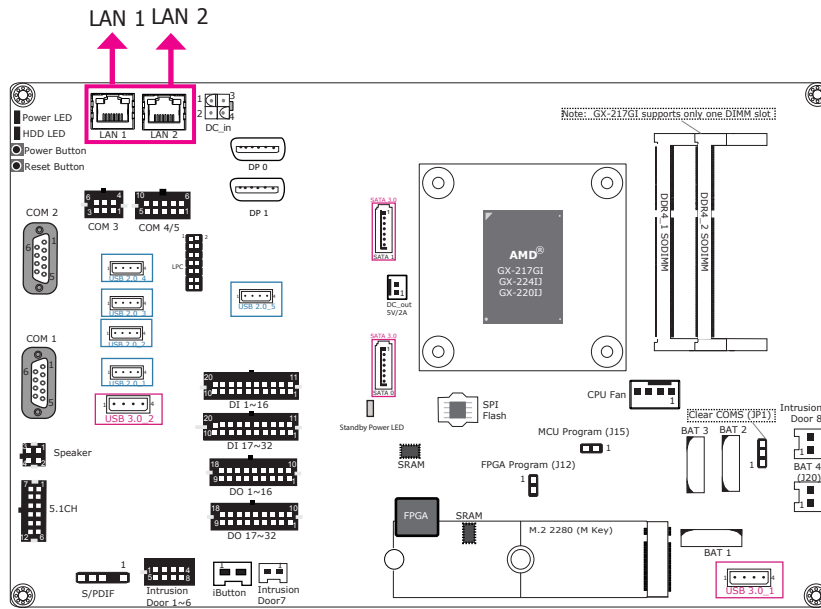

Intrusion Door

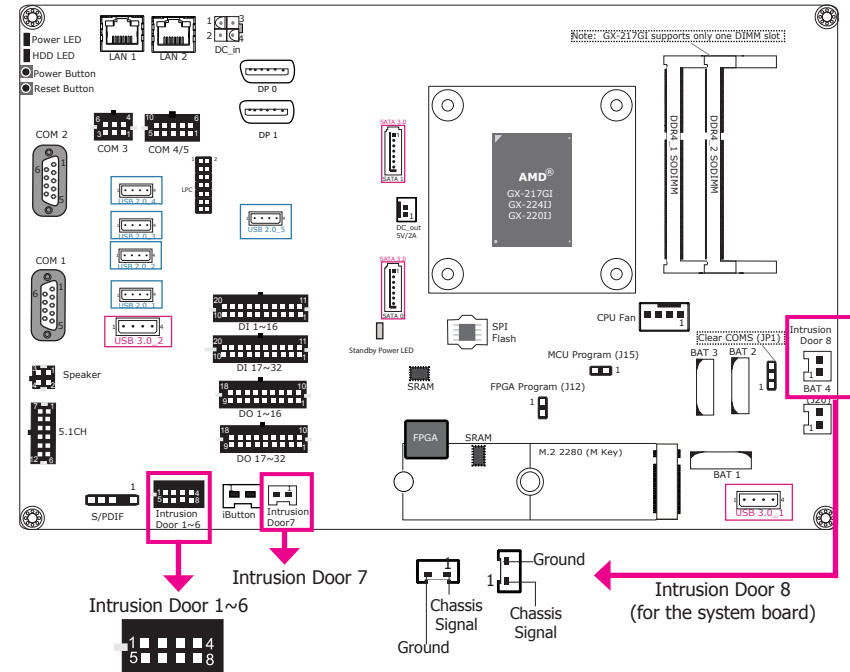

Features

- 2 Realtek® RTL8119 or 8111HN Gigabit Ethernet Controller

These LAN ports support WOL (Wake On LAN) and PXE (Preboot eXecution Environment) functions and they can be configured in the BIOS.

• BIOS Setting

Configure the onboard LAN in the "Advanced" menu ("ACPI" submenu) and the "Boot" menu ("PXE Boot Capability" submenu) of the BIOS. Refer to Chapter 7 for more information.

• Driver Installation

Install the LAN drivers. Refer to Chapter 8 for more information.

This intrusion door connector provides 6 pins plus two additional intrusion door connectors for detecting chassis intrusion events. The demonstration utility provides logging functions for recording up to 64 entries.

• Software

The software package that comes with the system contains application and code samples to implement door intrusion alarms for the system.

Display Outputs

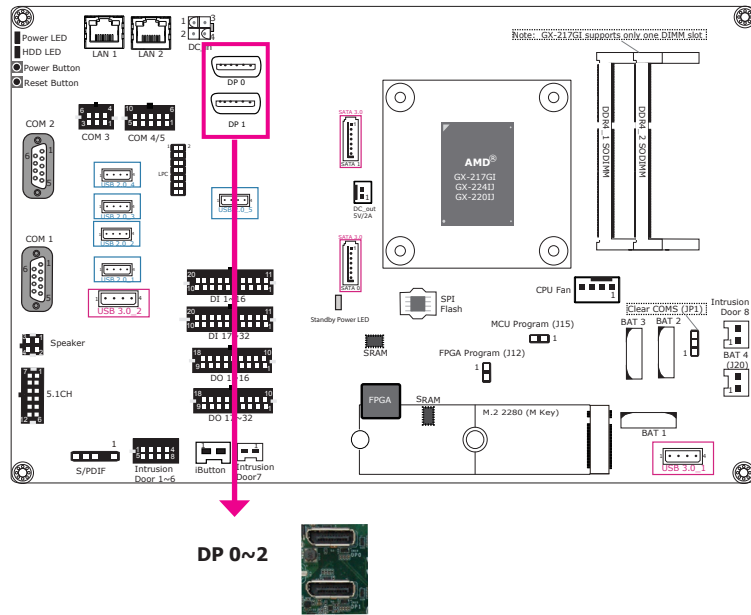

The DisplayPort (DP++), a digital display interface, supports 4K hardware video decode and encode with the integrated AMD® Radeon™ graphics (R6E, R4E and R2E depending on the processor) and can be connected to an LCD monitor. These ports support resolution up to 3840x2160.

• BIOS Setting

Configure the graphics device in the “Advanced” menu (“Video Configuration” submenu) of the BIOS. Refer to Chapter 7 for more information.

• Driver Installation

Install the AMD® Radeon™ graphics driver and software. Please refer to Chapter 8 for more information.

Digital Inputs/outputs

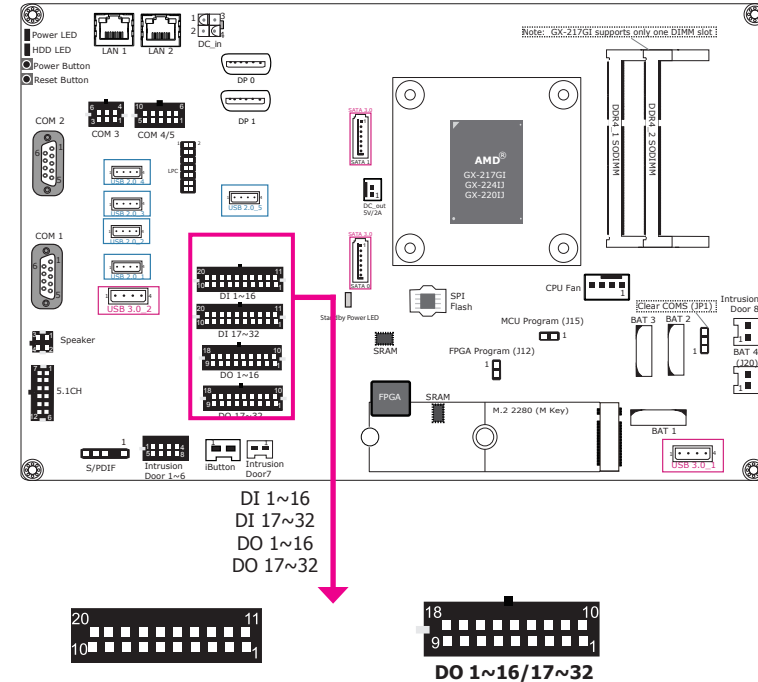

Digital Input 1~16/17~32

Pins	Pin Assignment	Pins	Pin Assignment
1	DI 1 / DI 17	11	DI 11 / DI 27
2	DI 2 / DI 18	12	DI 12 / DI 28
3	DI 3 / DI 19	13	DI 13 / DI 29
4	DI 4 / DI 20	14	DI 14 / DI 30
5	DI 5 / DI 21	15	DI 15 / DI 31
6	DI 6 / DI 22	16	DI 16 / DI 32
7	DI 7 / DI 23	17	GND
8	DI 8 / DI 24	18	GND
9	DI 9 / DI 25	19	GND
10	DI 10 / DI 26	20	GND

Digital Output 1~16/17~32

Pins	Pin Assignment	Pins	Pin Assignment
1	DO 1 / DO 17	11	DO 10 / DO 26
2	DO 2 / DO 18	12	DO 11 / DO 27
3	DO 3 / DO 19	13	DO 12 / DO 28
4	DO 4 / DO 20	14	DO 13 / DO 29
5	DO 5 / DO 21	15	DO 14 / DO 30
6	DO 6 / DO 22	16	DO 15 / DO 31
7	DO 7 / DO 23	17	DO 16 / DO 32
8	DO 8 / DO 24	18	GND
9	DO 9 / DO 25	19	GND

The Digital I/O connector provides 32-bit digital inputs or outputs to enable monitor and control of the states of the connected external devices. The recommended application voltage range is from 0 V to 24 V.

The digital I/O ports support Electrostatic discharge (ESD) protection to prevent damage from ESD strikes between two connected devices. The following are detailed features:

- Protects one data or I/O line
- Max. peak pulse power: 160W at $t_p = 8/20$ us.
- Low clamping voltage
- IEC 61000-4-2, level 4 (ESD), $>\pm 15$ KV (air); $>\pm 8$ KV (contact)

• **Software**

The system comes with a demonstration program and an API utility, allowing you to control digital I/O pins. The GPIO Control API of the GamingLogic API allows you to control the digital input/output pins. Please contact your sales representative for the gaming software package.

• **Driver Installation**

Install the Windows WinDriver. Please refer to Chapter 8 for more information.

I/O Connectors

Expansion Connectors

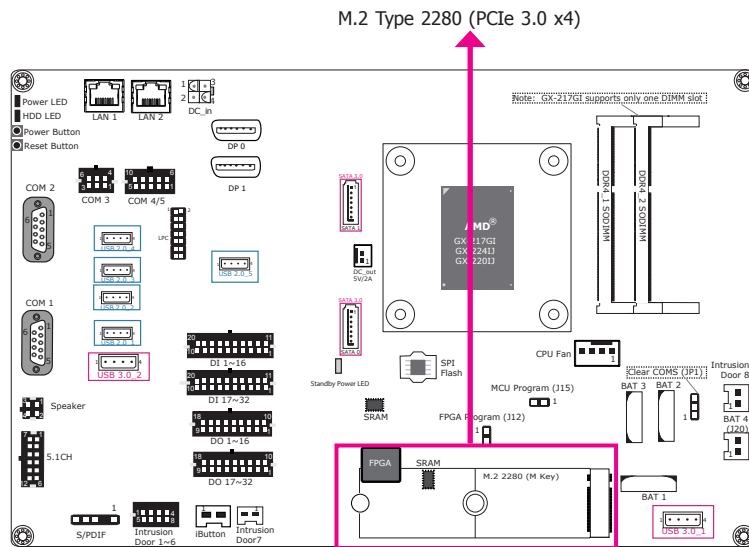

M.2 M Key slot

The M.2 type 2280 card slot (M Key) supports PCIe NVMe 3.0 x4 interface. It can be inserted with an M.2 (NGFF) card with the form factor of 22x80 mm.

- **BIOS Setting**

Configure the M.2 slot's PCIe signals including the PCIe speed in the Advanced menu ("PCI Express Configuration" submenu) of the BIOS. Refer to Chapter 7 for more information.

CPU Fan Connector

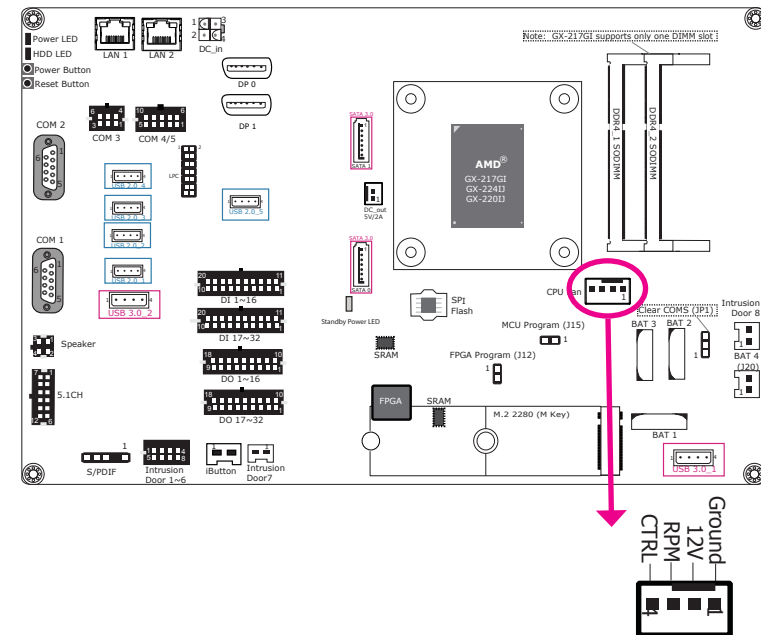

The fan connector is used to connect cooling fan. The cooling fan will provide adequate airflow throughout the chassis to prevent overheating the CPU and system board components.

- **BIOS Setting**

The Advanced menu ("Super I/O Configuration" submenu) of the BIOS will display the current speed of the cooling fans. Please refer to Chapter 7 for more information.

LEDs

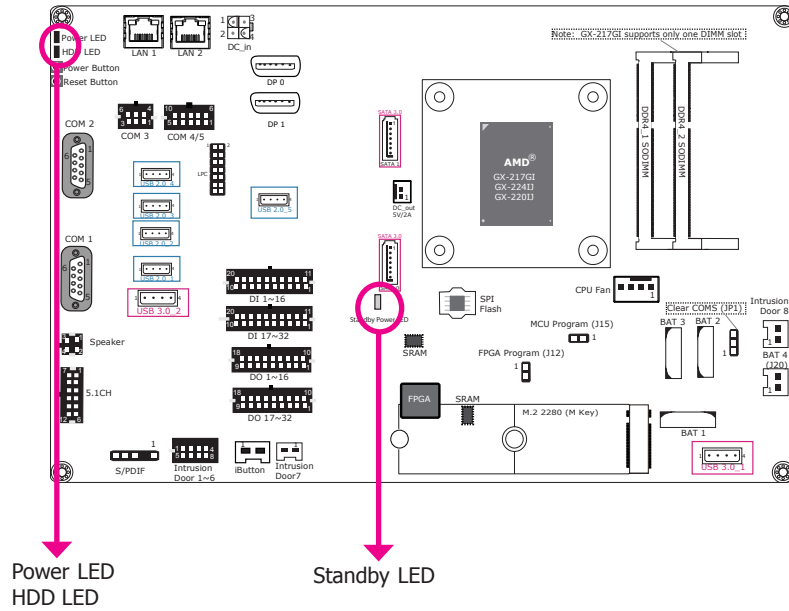

Power LED

This LED will be green when the system is powered on.

HDD LED

The HDD LED will flash orange when storage devices are being accessed.

Standby LED

This LED will be red when power is applied to the system board.

Battery

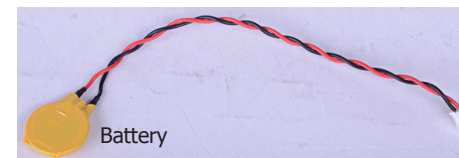
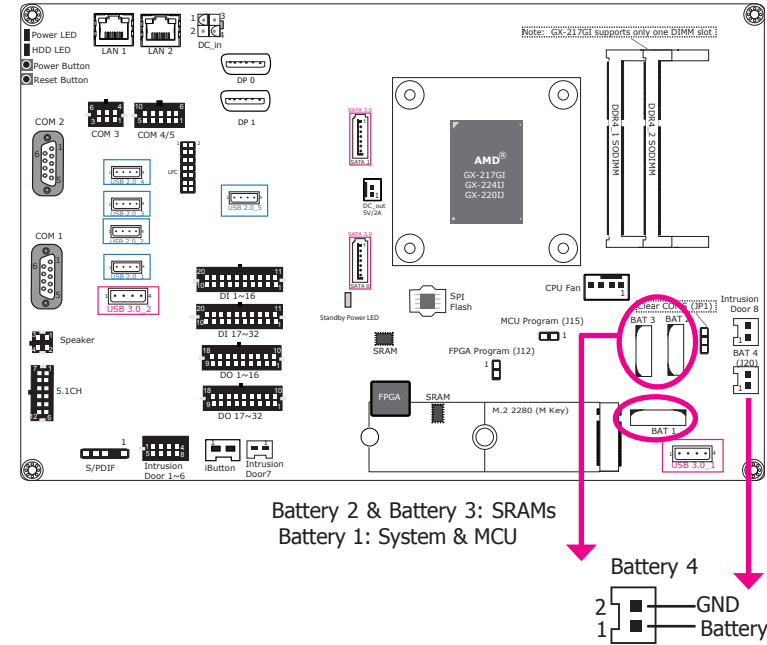

Connect to the battery connector 4

The lithium-ion battery is an auxiliary source of power when the main power is shut off. Two of them provide power for the Static Random-Access memory (BAT 2 & 3) and one provides power for the MCU and the system's CMOS memory (BAT 1). The optional BAT 4 connector can be used to extend the retention time of the SRAM.

Safety Measures

- Danger of explosion if battery is incorrectly replaced.
- Replace only with the same or equivalent type recommend by the manufacturer.
- Dispose of used batteries according to local ordinance.

SATA (Serial ATA) Connectors

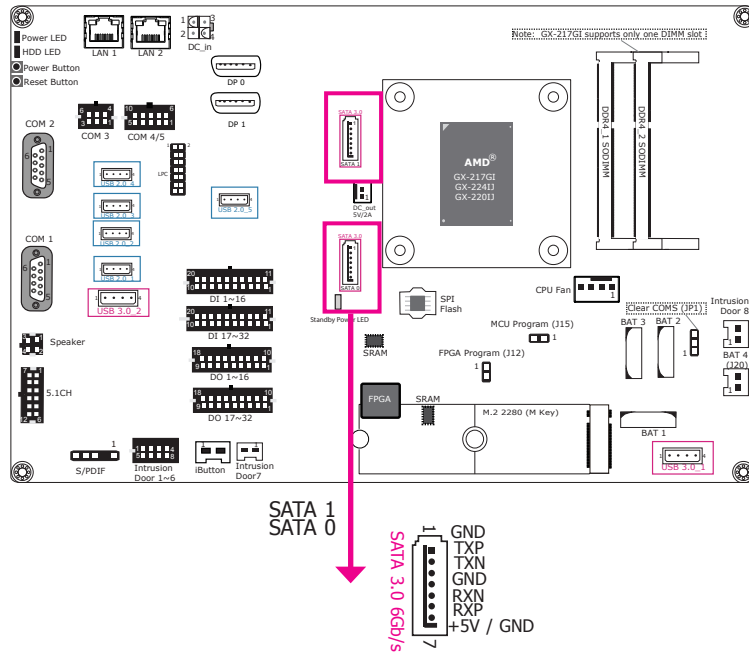

Features

- 2 Serial ATA 3.0 ports
- SATA port 0 and 1 with data transfer rate up to 6Gb/s
- Pin 7 provides +5V power and can switch between +5V and GND automatically

The Serial ATA connectors are used to connect the Serial ATA device, i.e., a SATA DOM. For SATA DOM that requires external power supply, there is a 5V DC-out connector. Please refer to 5V DC-out on the next page.

• BIOS Setting

Configure the Serial ATA drives in the Advanced menu ("SATA Configuration" submenu) of the BIOS. Refer to Chapter 7 for more information.

LPC Connector

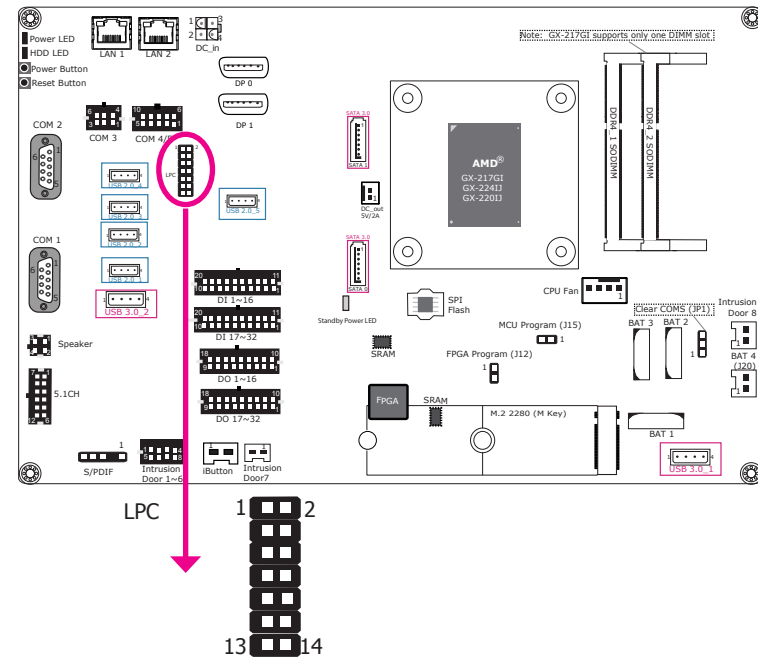

Pin	Pin Assignment	Pin	Pin Assignment
1	L_CLK	2	L_AD1
3	L_RST#	4	L_AD0
5	L_FRAME#	6	3V3
7	L_AD3	8	GND
9	L_AD2	10	Key
11	INT_SERIRQ	12	GND
13	5VSB	14	5V

The Low Pin Count Interface was defined by Intel® Corporation to facilitate the industry's transition towards legacy free systems. It allows the integration of low-bandwidth legacy I/O components within the system, which are typically provided by a Super I/O controller. Furthermore, it can be used to interface firmware hubs, Trusted Platform Module (TPM) devices and embedded controllers. Data transfer on the LPC bus is implemented over a 4 bit serialized data interface, which uses a 24MHz LPC bus clock. For more information about LPC bus, please refer to the Intel® Low Pin Count Interface Specification Revision 1.1'. The table above indicates the pin functions of the LPC connector.

• BIOS Setting

Configure the LPC port's connection to a TPM module in the Advanced ("Peripheral Configuration" submenu) and the "Security" menus of the BIOS. Refer to Chapter 7 for more information.

5V DC-out

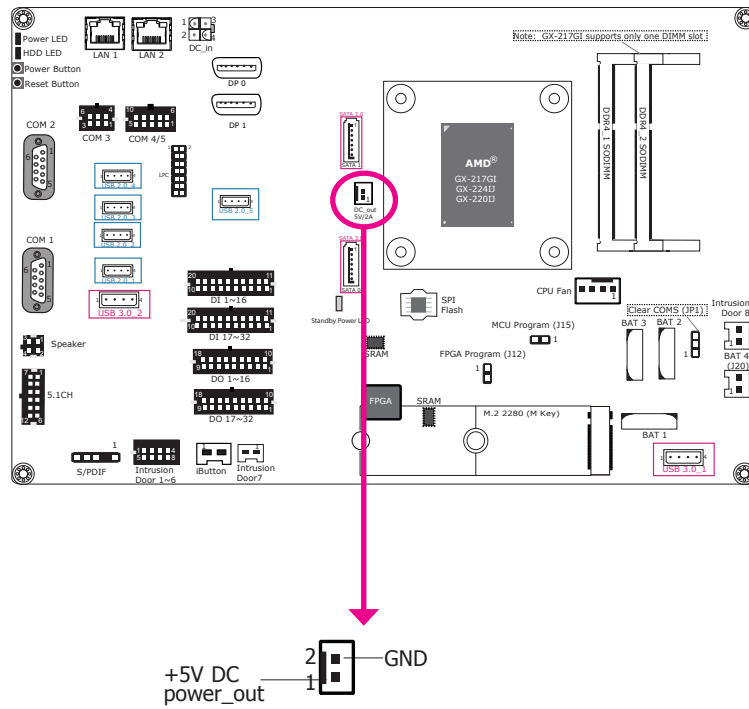

The 2-pin connector provides low power output of 5V/2A for SATA DOMs or other devices that require external power supply.

Chapter 6 - Mounting

**Note:**

The system unit used in the following illustrations may not resemble the actual one. These illustrations are for reference only.

Wall Mount

The system has screw holes on the bottom of the chassis to support wall mount.

1. Drill 4 holes in the wall and insert screw bolts into the holes.
2. Drill the screws into the screw anchors.
3. Hang the device on the wall.

The diagram on the right shows the screw holes and dimensions of wall mount (in millimeter).

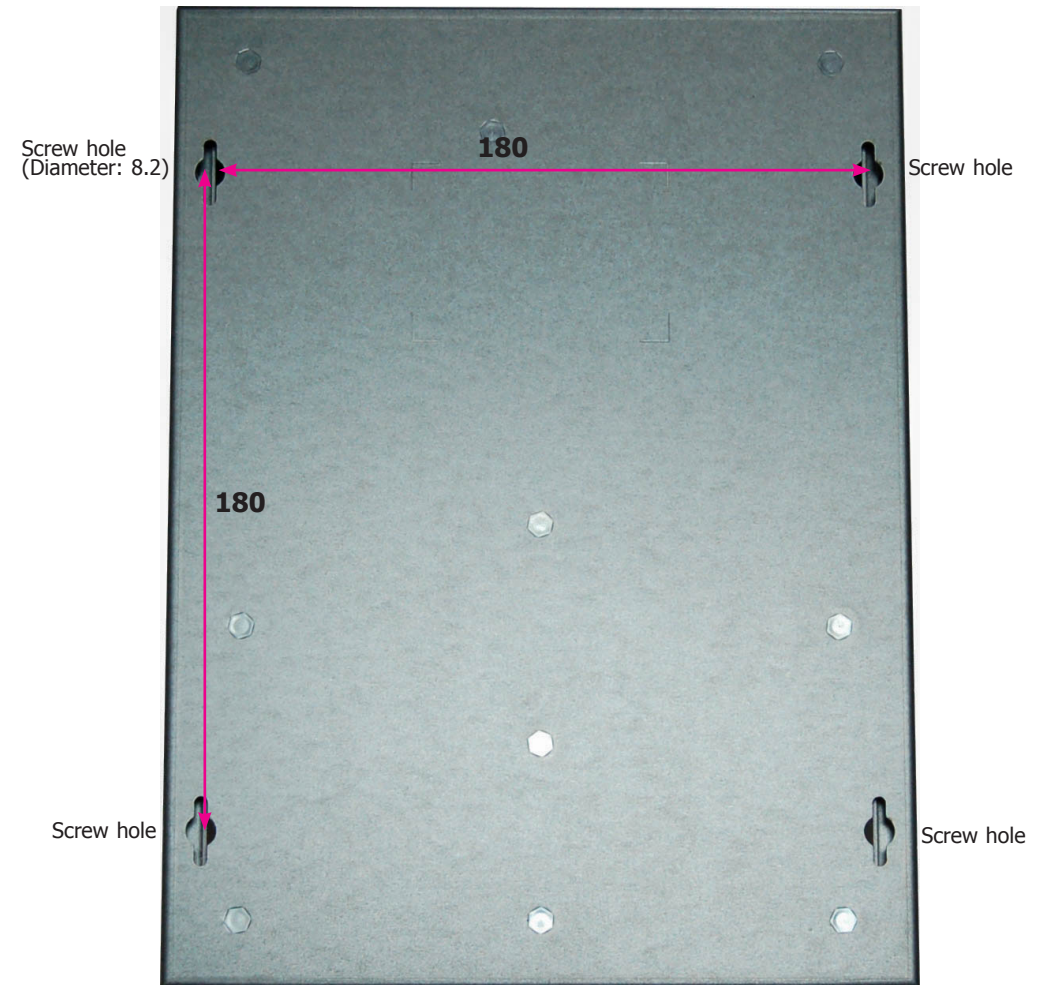

Chapter 7 - BIOS Setup

Overview

The BIOS is a program that takes care of the basic level of communication between the CPU and peripherals. It contains codes for various advanced features found in this system board. The BIOS allows you to configure the system and save the configuration in a battery-backed CMOS so that the data retains even when the power is off. In general, the information stored in the CMOS RAM of the EEPROM will stay unchanged unless a configuration change has been made such as a hard drive replaced or a device added.

It is possible that the CMOS battery will fail causing CMOS data loss. If this happens, you need to install a new CMOS battery and reconfigure the BIOS settings.



Note:

The BIOS is constantly updated to improve the performance of the system board; therefore the BIOS screens in this chapter may not appear the same as the actual one. These screens are for reference purpose only.

Default Configuration

Most of the configuration settings are either predefined according to the Load Optimal Defaults settings which are stored in the BIOS or are automatically detected and configured without requiring any actions. There are a few settings that you may need to change depending on your system configuration.

Entering the BIOS Setup Utility

The BIOS Setup Utility can only be operated from the keyboard and all commands are keyboard commands. The commands are available at the right side of each setup screen.

The BIOS Setup Utility does not require an operating system to run. After you power up the system, the BIOS message appears on the screen and the memory count begins. After the memory test, the message "Press DEL to run setup" will appear on the screen. If the message disappears before you respond, restart the system or press the "Reset" button. You may also restart the system by pressing the <Ctrl> <Alt> and keys simultaneously.

Legends

Keys	Function
Right and Left arrows	Moves the highlight left or right to select a menu.
Up and Down arrows	Moves the highlight up or down between submenu or fields.
<Esc>	Exit the current menu
+ (plus key)	Scrolls forward through the values or options of the highlighted field.
- (minus key)	Scrolls backward through the values or options of the highlighted field.
<F1>	Displays general help
<F9>	Optimized defaults
<F5/F6>	Change values
<F10>	Save and Exit
<Enter>	Press <Enter> to enter the highlighted submenu.

Scroll Bar

When a scroll bar appears to the right of the setup screen, it indicates that there are more available fields not shown on the screen. Use the up and down arrow keys to scroll through all the available fields.

Submenu

When "►" appears on the left of a particular field, it indicates that a submenu which contains additional options are available for that field. To display the submenu, move the highlight to that field and press <Enter>.

Insyde BIOS Setup Utility

Main

The Main menu is the first screen that you will see when you enter the BIOS Setup Utility.

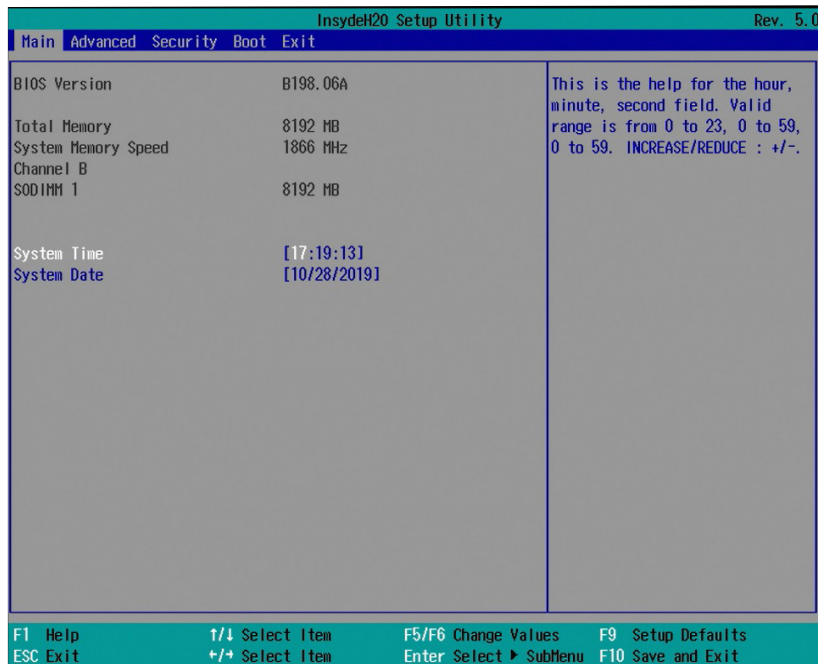

System Time

The time format is <hour>, <minute>, <second>. The time is based on the 24-hour military-time clock. For example, 1 p.m. is 13:00:00. Hour displays hours from 00 to 23. Minute displays minutes from 00 to 59. Second displays seconds from 00 to 59.

System Date

The date format is <month>, <date>, <year>. Month displays the month, from January to December. Date displays the date, from 1 to 31. Year displays the year, from 1980 to 2099.

Advanced

The Advanced menu allows you to configure your system for basic operation. Some entries are defaults required by the system board, while others, if enabled, will improve the performance of your system or let you set some features according to your preference.



Important:

Setting incorrect field values may cause the system to malfunction.

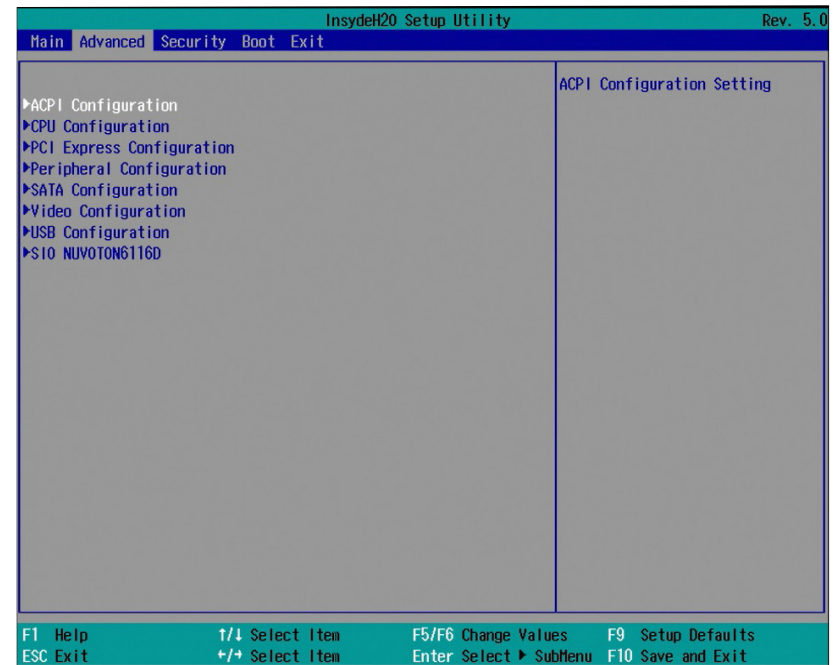

ACPI Configuration

This section configures system ACPI parameters.

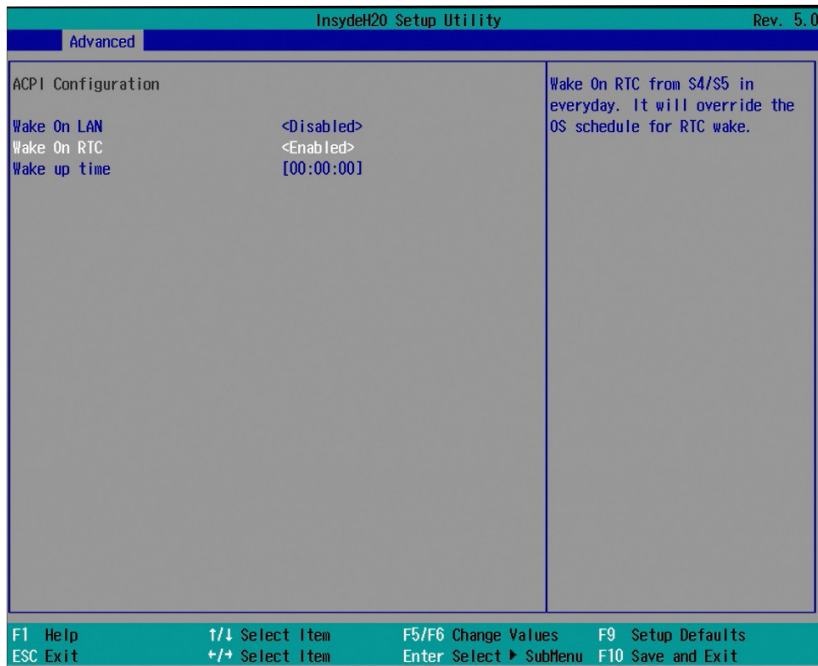

Wake on LAN

Enable or disable WOL (wake-on-LAN) to wake the system through an Ethernet adapter. The default is disabled.

Wake on RTC from S5

Enable or disable the resume on RTC alarm function, which automatically powers on the system from S4 (suspend to disk) or S5 power state (soft-off state) at the specified time every day. The default is disabled.

Wake up hour Input any value between 0 and 23.

Wake up minute Input any value between 0 and 59. Suspend to Disk

Wake up second Input any value between 0 and 59.

CPU Configuration

This section configures the CPU.

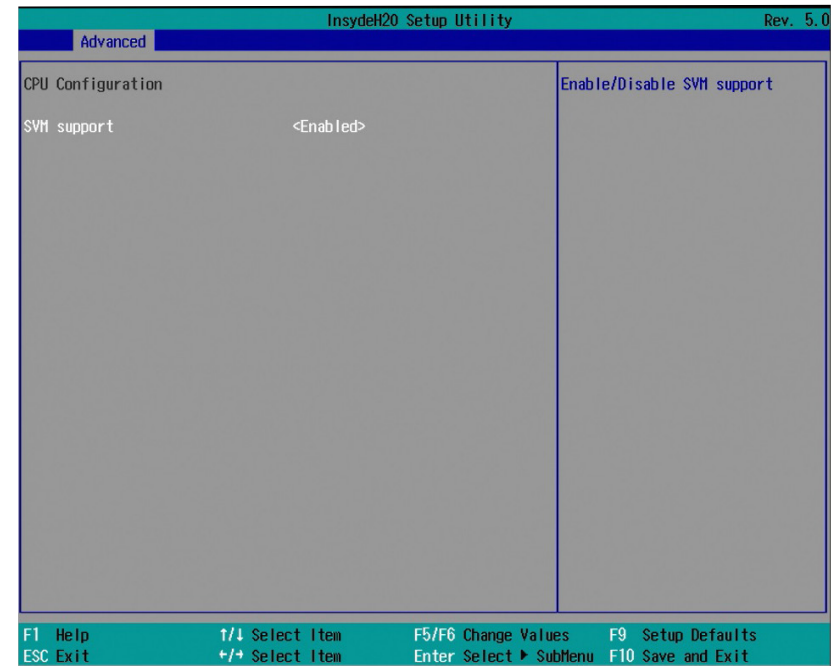

SVM Support

Enable or disable the CPU virtualization function. The default is enabled.

PCI Express Configuration

This section configures the settings of PCI Express root ports.

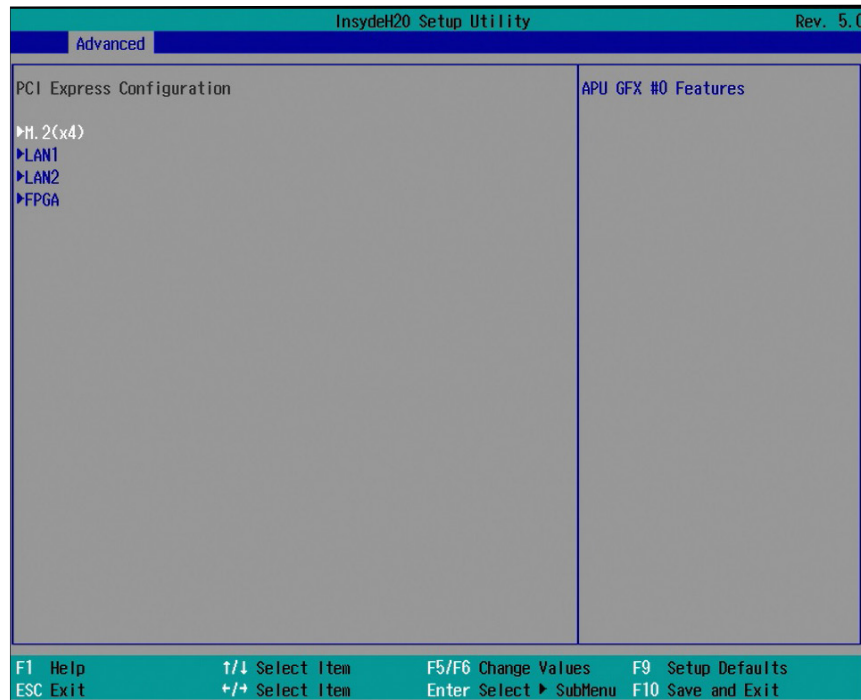

M.2

Controls the PCIe signal of the M.2 Type 2280 slot.

LAN 1

Controls the PCIe signal of the LAN port 1.

LAN 2

Controls the PCIe signal of the LAN port 2.

FPGA

Controls the PCIe signal connected to the onboard FPGA.

Press "Enter" to enter the configurations for each PCIe root port as shown on the right.

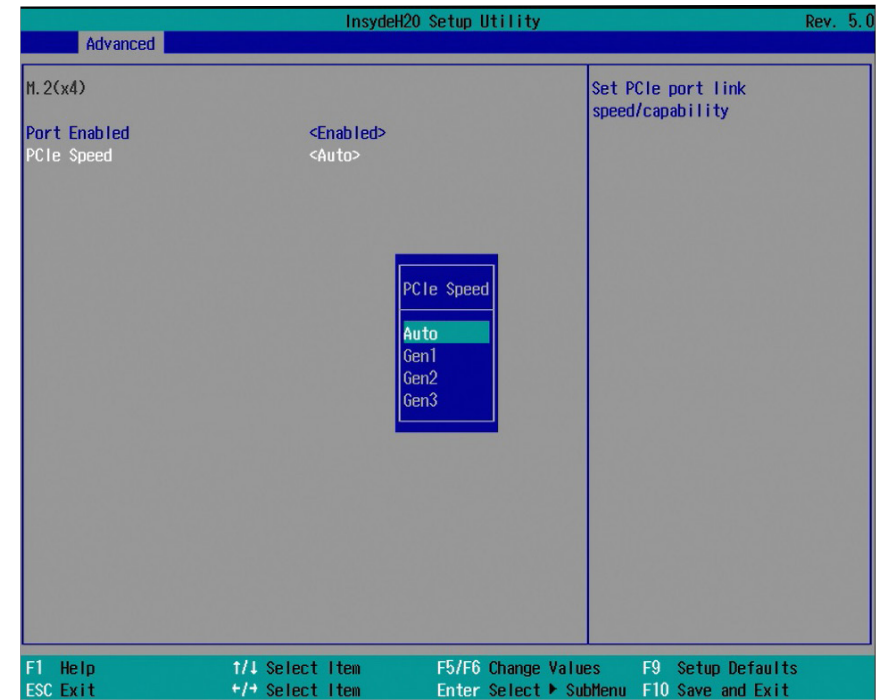

PCI Express Root Port

Enable or disable this PCI Express root port. The default is enabled.

PCIe Speed

Select the speed of the PCI Express Root Port: Auto, Gen1 (2.5 GT/s), Gen2 (5 GT/s) or Gen3 (8.0 GT/s).

Peripheral Configuration

This section configures peripherals settings.

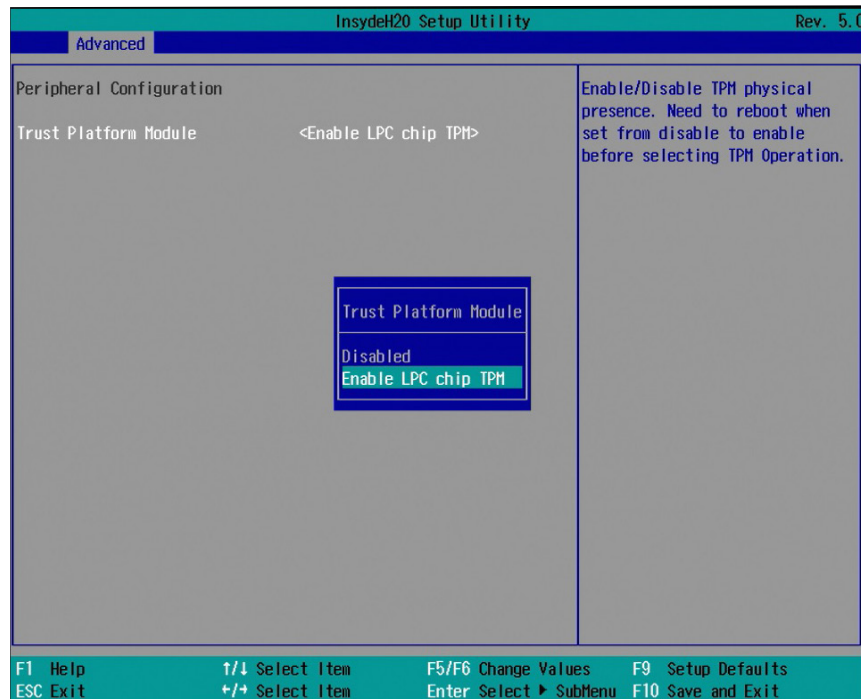

Trusted Platform Module

Enable or disable the connection to a TPM device via the onboard LPC connector.

Enable LPC chip TPM

Enable the connection to a TPM device via the onboard LPC connector. This is the default setting.

Disabled

Disable the connection. For more information on TPM, please refer to the "Security" tab.

SATA Configuration

This section configures SATA devices. It also shows the information about the installed SATA drives.

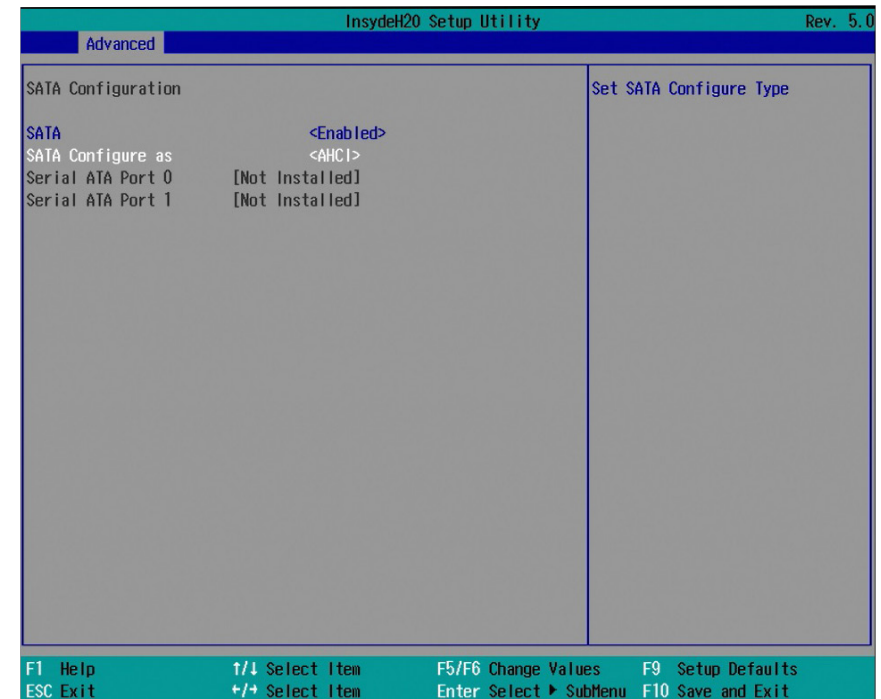

SATA

Enable or disable the Serial ATA controller. The default is enabled.

SATA Configured as

The mode selection determines how the SATA controller(s) operates.

AHCI Mode

This option sets the Serial ATA devices to use AHCI (Advanced Host Controller Interface). This is the default setting.

IDE

This option sets the Serial ATA devices to use IDE (Integrated Device Electronics).

Serial ATA Port 0, 1 and 2 and Hot Plug

Enable or disable each Serial ATA port and its hot plug function.

Video Configuration

This section configures the video settings.

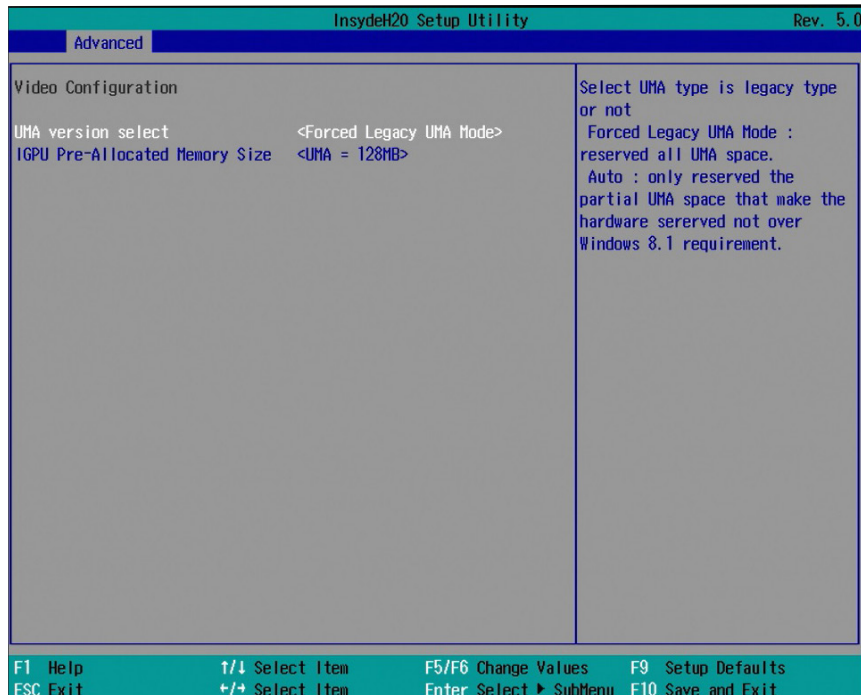

UMA Version Select

Select the memory mode used for integrated graphics cards: Forced legacy UMA mode (default) or Auto.

IGPU Pre-Allocated Memory Size

Set the pre-allocated UMA memory size if the legacy UMA mode is selected for the above option. Options: Auto, 32MB, 64MB, 128MB (Default), 256MB, 512MB, 1024MB, and 2048 MB.

USB Configuration

This section configures the parameters of the USB devices.

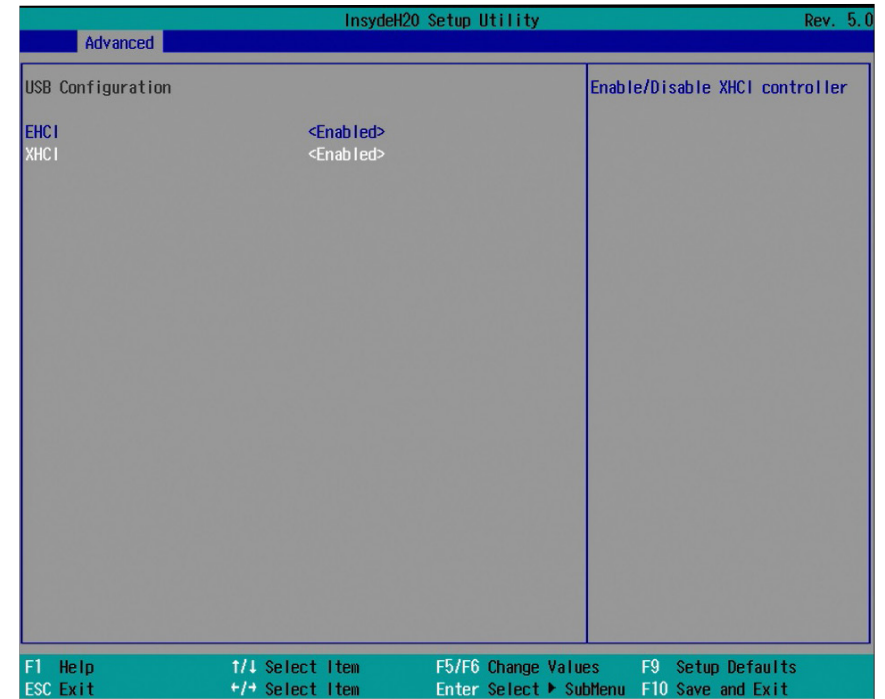

USB Configuration

EHCI

Enable or disable the Enhanced Host Controller Interface (EHCI) support for USB 2.0 ports. The default is enabled.

xHCI

Enable or disable the eXtensible Host Controller Interface (xHCI) support for USB 3.0 ports. The default is enabled.

Super I/O

This section configures the system super I/O chip parameters.

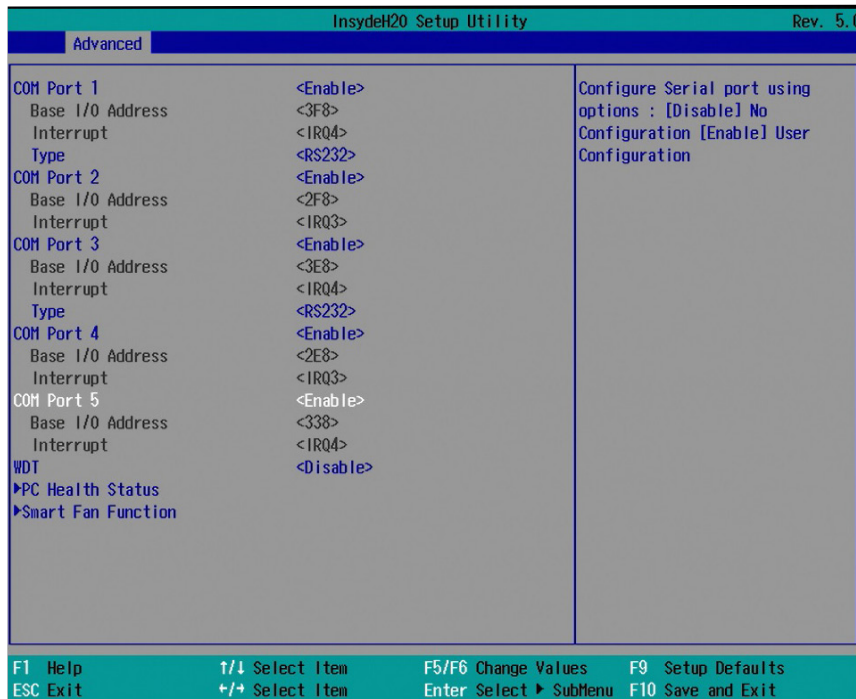

COM Port 1 to COM Port 5

Enable or disable the serial port (COM).

Device Settings

It shows the IO/IRQ settings for the COM port.

COM Type (only available for Serial Port 1 and 3)

Configure the serial port mode. The settings are RS232, RS422 and RS485 for COM Port 1, and RS232 and CC-TALK for COM Port 3.

WDT

Enable or disable the watchdog function (default: disabled). A counter will appear if you select to enable WDT. Input any value between 1 and 255 (seconds).

PC Health Status

This section displays PC health status.

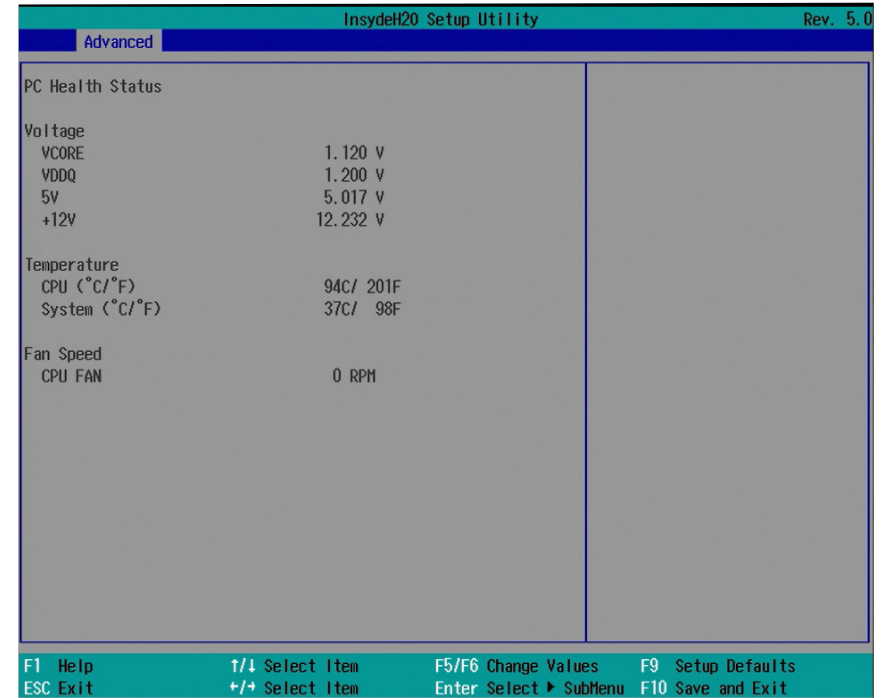

Smart Fan Function

This section sets the smart fan function.

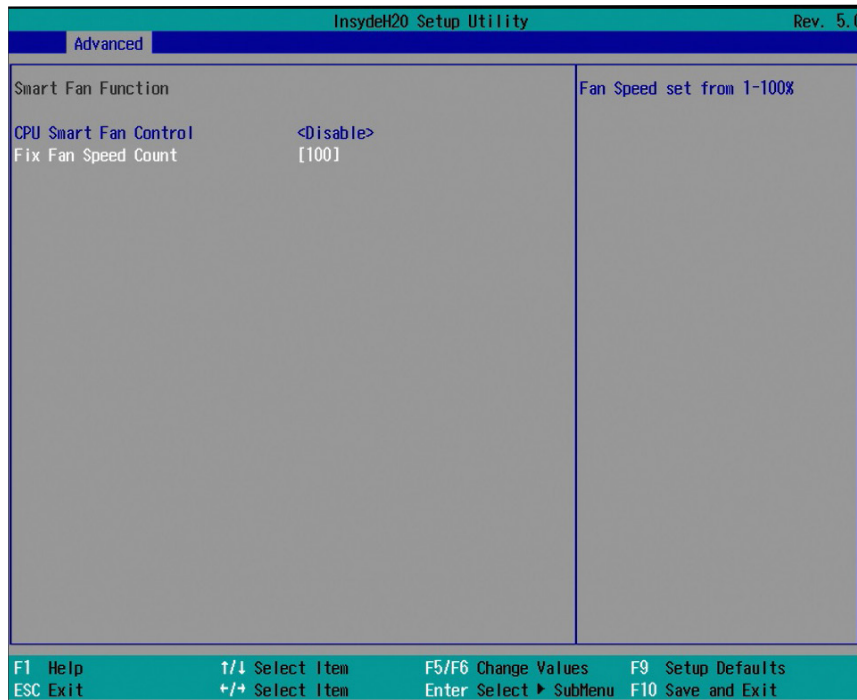

CPU Smart Fan Function

Enable or disable CPU smart fan control (the default is enabled).

Fix Fan Speed Count

Set a constant fan speed. The range is from 1 (lowest speed)-100% (full speed).

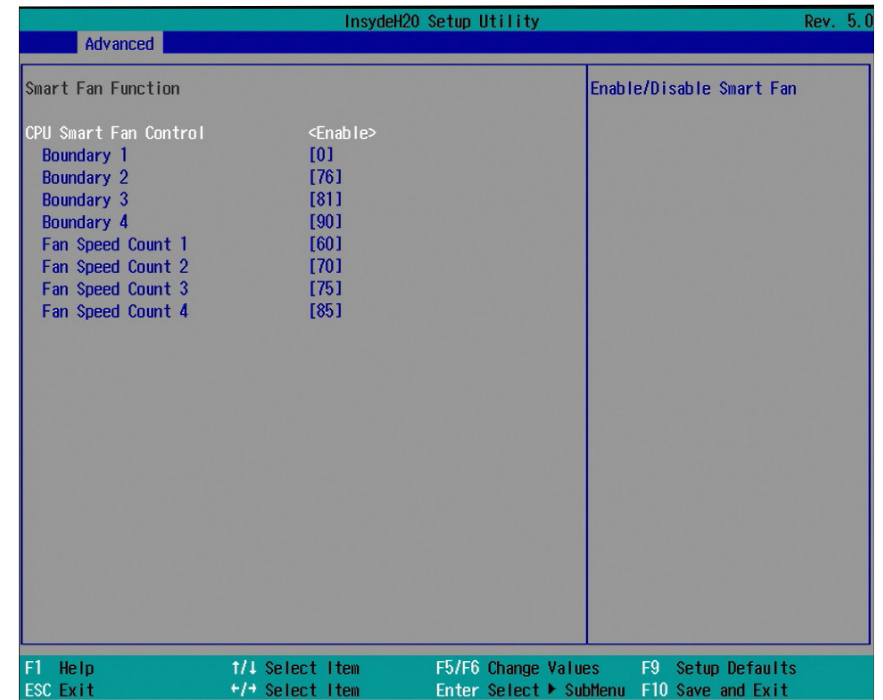

CPU Smart Fan Function

Enable or disable CPU smart fan control (the default is enabled).

Boundary 1 to Boundary 4

Set the boundary temperatures that determine the operation of the fan with different fan speeds accordingly. For example, when the CPU temperature reaches boundary temperature 1, the CPU fan should be turned on and operate at the designated speed.

The range of the temperature is from 0 to 127°C.

Fan Speed Count 1 to Fan Speed Count 4

Set the fan speed. The range is from 1 (lowest speed)-100% (full speed).

Security

This section configures the Trusted Platform Module (TPM) function.

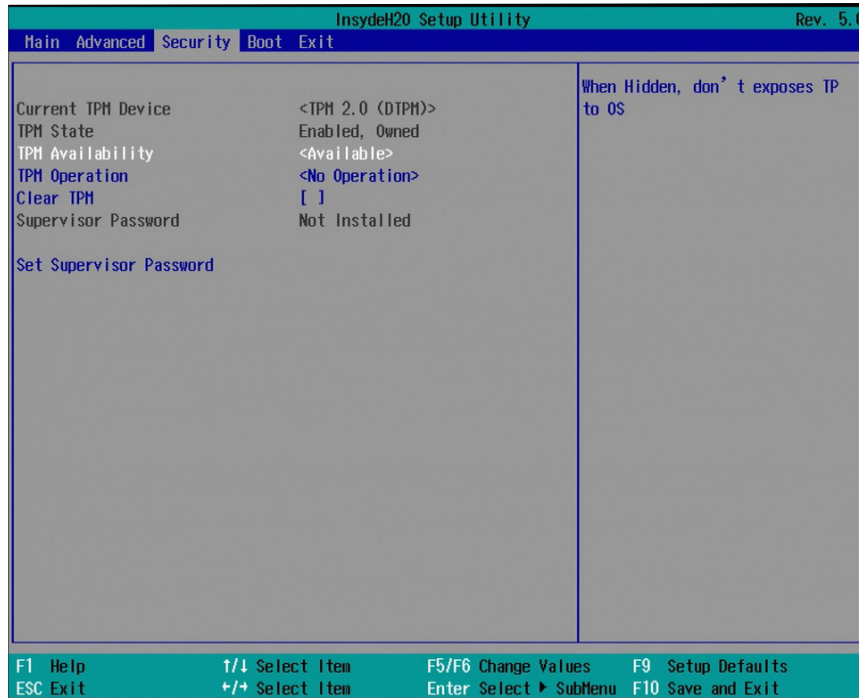

TPM Availability

Show or hide TPM availability and its configurations.

TPM Operation

Select one of the supported operation: Enable, Disable, or No Operation.

- No Operation: No changes to the current state. This is the default setting.
- Disable: Disable and deactivate TPM.
- Enable: Enable and activate TPM.

Clear TPM

Remove all TPM ownership contents.

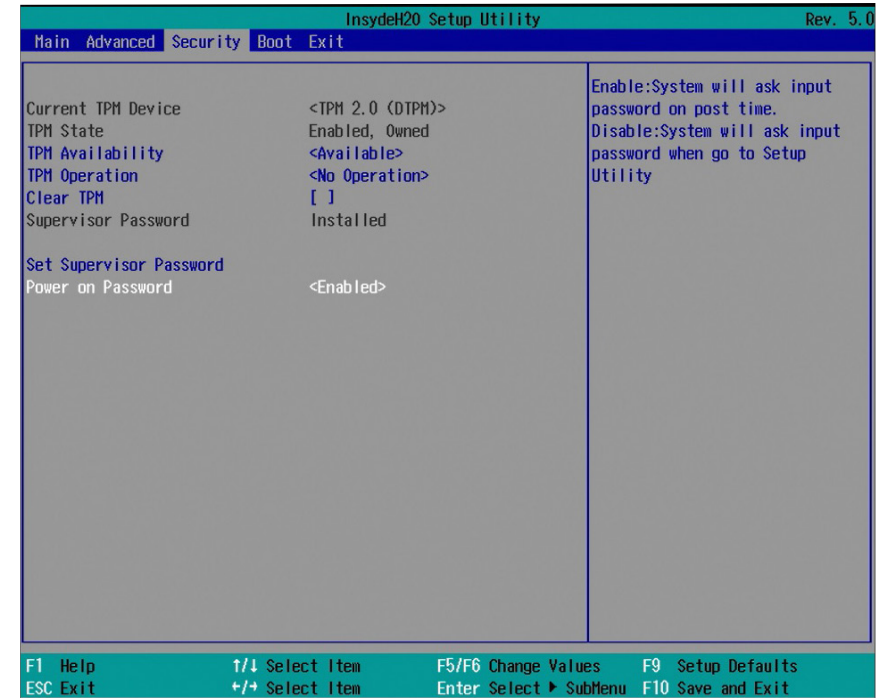

Set Supervisor Password

Set the administrative password for entering the BIOS utility or upon the entering of the power-on self-test (POST) process. The length of the password must be greater than 1 character and less than or equal to 10 characters.

Power-on Password

If you select to set the supervisor password, this option will be shown. Enable or disable the system to require password at boot.

Boot

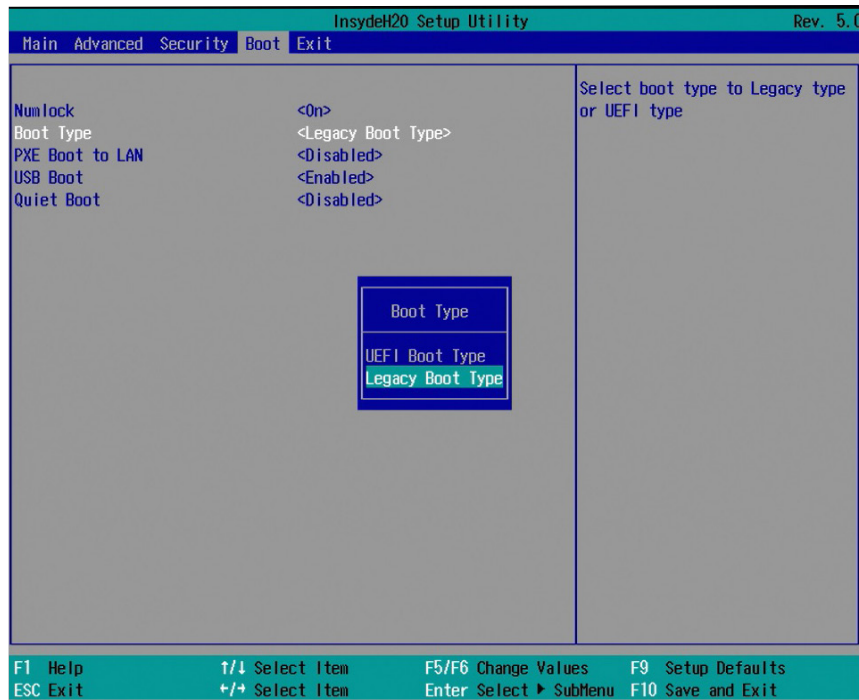

Numlock

This allows you to determine the default state of the numeric keypad at boot. By default, the system boots up with Num Lock on. When set to Off, the function of the numeric keypad is the arrow keys.

Boot Type

Select the boot type. The options include Legacy Boot Type (the default) and UEFI Boot Type.

Network Stack

Enable or disable network stack. It supports the operation of these functions or software: Windows 8 BitLocker Network Unlock and UEFI IPv4/IPv6 PXE or legacy PXE OPROM.

PXE Boot Capability (UEFI mode)/PXE Boot to LAN (legacy mode)

Enable or disable Preboot eXecution Environment (PXE) boot through an Ethernet port. This function can only be enabled if the Network Stack support is enabled under the UEFI Boot Type.

USB Boot

Enable or disable USB boot from a flash drive.

Quiet Boot

Enable or disable the quiet boot function to configure the screen's display between POST messages or the OEM logo at bootup. Select Disabled to display the POST messages and select Enabled to display the OEM logo.

Exit

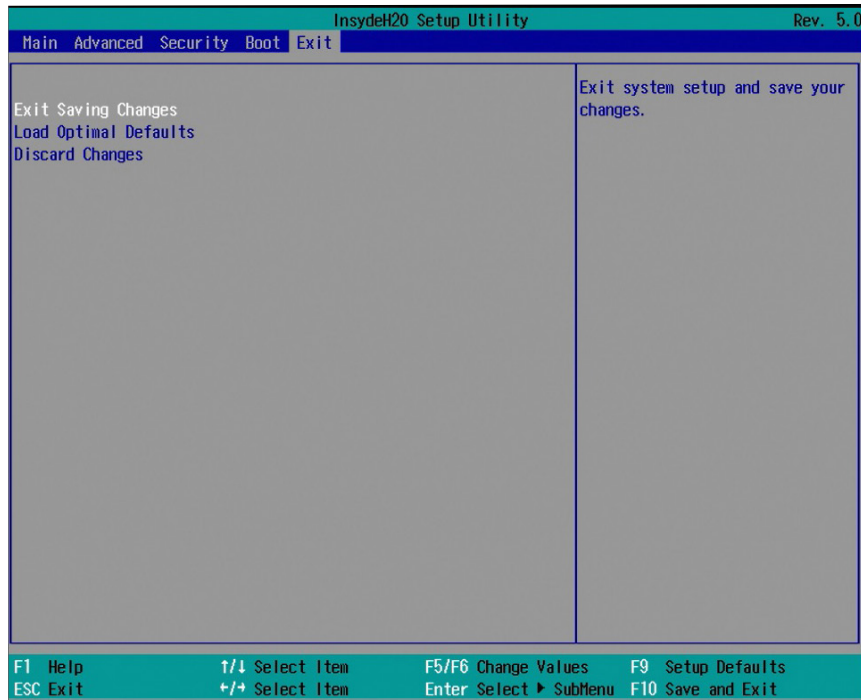

Exit Saving Changes

Select this field and press <Enter> to exit BIOS setup and save your changes.

Load Optimal Defaults

Select this field and press <Enter> to load the optimal defaults.

Discard Changes

Select this field and press <Enter> to exit the BIOS setup without saving your changes.

Updating the BIOS

To update the BIOS, you will need the new BIOS file and a flash utility. Please contact technical support or your sales representative for the latest BIOS file and the firmware update utility. For instructions on how to update BIOS with the flash utility, please see <https://www.dfi.com/knowledge/video/31> from the Knowledge Base of the DFI website.

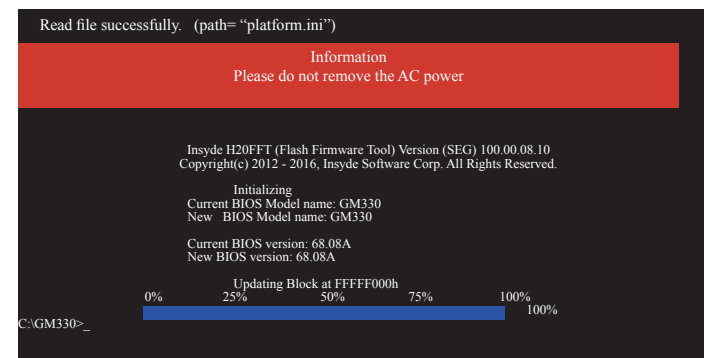

Chapter 8 - Supported Software

The system requires you to install drivers for some devices to operate properly. To download the latest driver, please go to the DFI Download Center:

<http://www.dfi.com/DownloadCenter>

Once you are in the Download Center page, select your product or type the model name and click "Search" to find product-related resources such as documentation and drivers.

Drivers are available for the following devices in Windows 10:

- AMD® Chipset and VGA Drivers
- Realtek RTL8119 LAN Drivers
- Gaming Drivers

AMD® Chipset and VGA Drivers

The AMD Radeon™ software provides drivers and configuration utilities for AMD Radeon™ Vega 11 Graphics. To install this software, click the executable file to begin the installation.

1. Read the End User License Agreement then click "Accept and Install" to continue the installation or click on X to stop the installation.

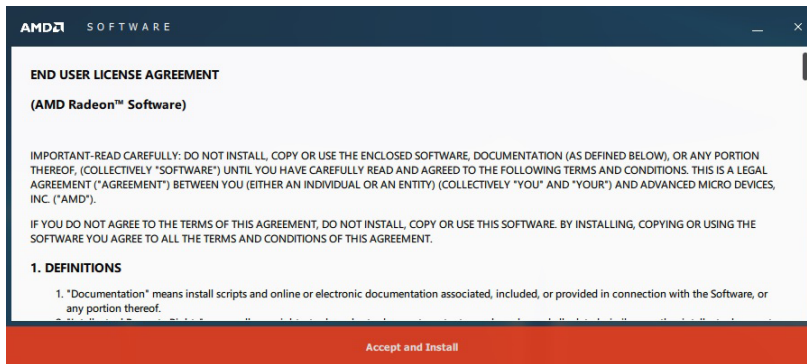

2. Choose between "Express Install" or "Custom Install". The "Express Install" installs all the programs in the default folder.

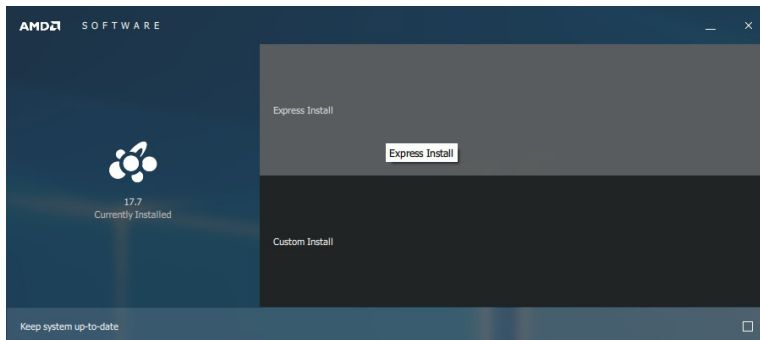

3. The "Custom Install" provides the option to select the programs that you would like to install and the folder for installation.



4. Please wait while the software and drivers are being installed.



5. Once the Radeon™ Software has been successfully installed, choose "Restart Now".

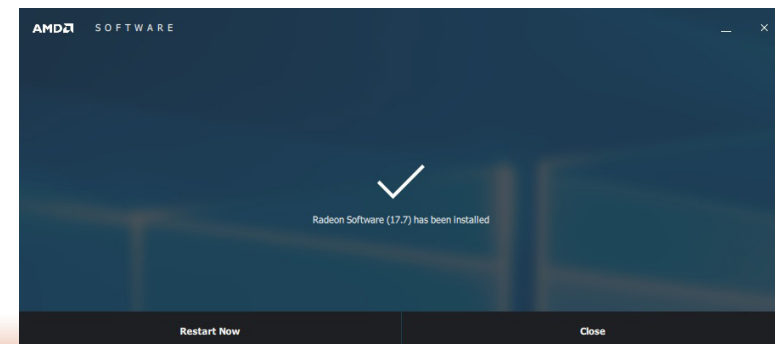

Realtek LAN Drivers

The onboard LAN ports are provided by Realtek Gigabit Ethernet controllers. To install the driver, click the executable file inside the LAN Driver folder.

1. After the software package has done preparing the software package, click "Next" to continue.

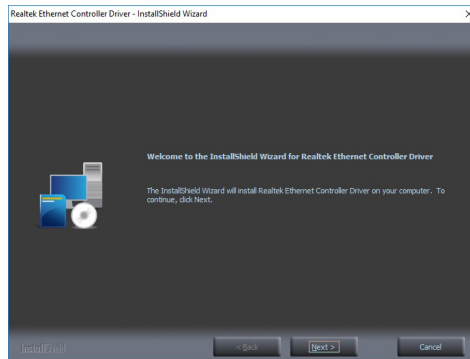

2. Click "Install" to start the installation.

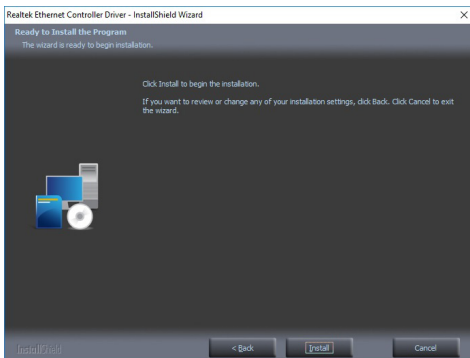

3. Click "Finish" to exit the wizard after the installation is complete.

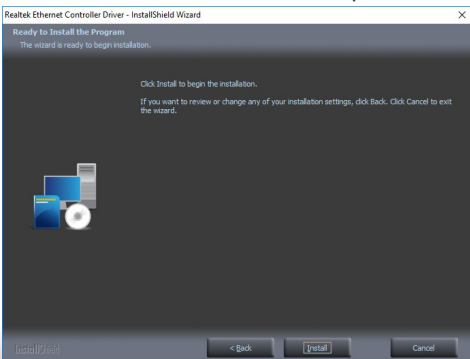

WinDriver

The gaming platform employs digital input/output devices. For the digital I/O functions to work properly, the WinDriver USB/PCI driver must be installed. To install the driver, click the executable file inside the gaming driver folder.

1. Setup is now ready to install WinDriver USB/PCI Version 12.3.0. Click "Next" to continue.

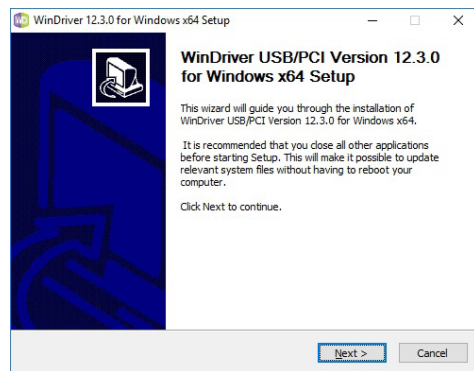

2. Read the license agreement then click "Yes" to continue.

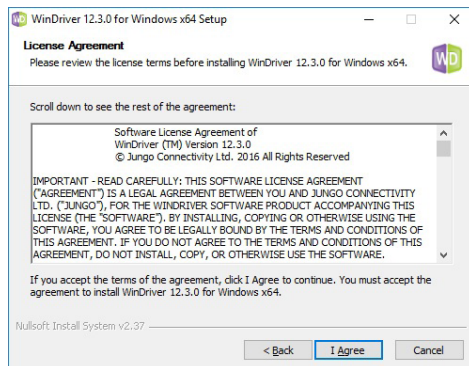

3. Follow the on-screen instructions to complete the rest of the installation process.

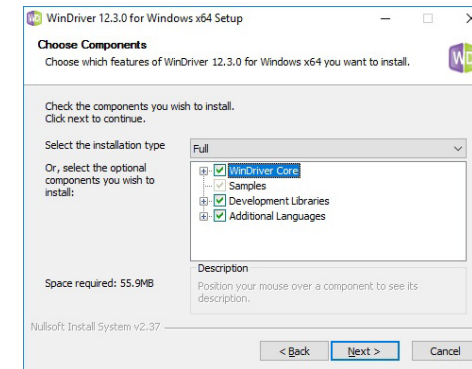

4. Please wait while the Setup is installing the driver.

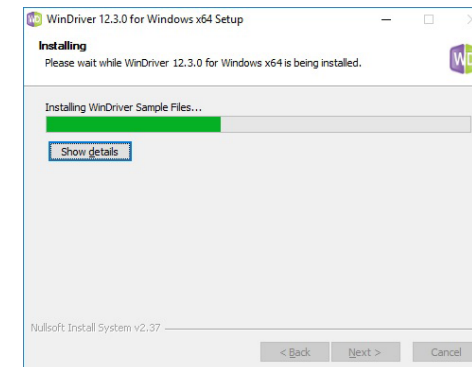

5. Click "Finish" to exit the Setup wizard.

