

KU171/KU173

Mini-ITX Industrial Motherboard

User's Manual

Copyright

This publication contains information that is protected by copyright. No part of it may be reproduced in any form or by any means or used to make any transformation/adaptation without the prior written permission from the copyright holders.

This publication is provided for informational purposes only. The manufacturer makes no representations or warranties with respect to the contents or use of this manual and specifically disclaims any express or implied warranties of merchantability or fitness for any particular purpose. The user will assume the entire risk of the use or the results of the use of this document. Further, the manufacturer reserves the right to revise this publication and make changes to its contents at any time, without obligation to notify any person or entity of such revisions or changes.

Changes after the publication's first release will be based on the product's revision. The website will always provide the most updated information.

© 2018. All Rights Reserved.

Trademarks

Product names or trademarks appearing in this manual are for identification purpose only and are the properties of the respective owners.

FCC and DOC Statement on Class B

This equipment has been tested and found to comply with the limits for a Class B digital device, pursuant to Part 15 of the FCC rules. These limits are designed to provide reasonable protection against harmful interference when the equipment is operated in a residential installation. This equipment generates, uses and can radiate radio frequency energy and, if not installed and used in accordance with the instruction manual, may cause harmful interference to radio communications. However, there is no guarantee that interference will not occur in a particular installation. If this equipment does cause harmful interference to radio or television reception, which can be determined by turning the equipment off and on, the user is encouraged to try to correct the interference by one or more of the following measures:

- Reorient or relocate the receiving antenna.
- Increase the separation between the equipment and the receiver.
- Connect the equipment into an outlet on a circuit different from that to which the receiver is connected.
- Consult the dealer or an experienced radio TV technician for help.

Notice:

1. The changes or modifications not expressly approved by the party responsible for compliance could void the user's authority to operate the equipment.
2. Shielded interface cables must be used in order to comply with the emission limits.

Table of Contents

Copyright.....	2
Trademarks.....	2
FCC and DOC Statement on Class B.....	2
Warranty.....	4
Static Electricity Precautions.....	4
Safety Measures.....	4
About the Package.....	5
Optional Items.....	5
Before Using the System Board.....	5
Chapter 1 - Introduction.....	6
Specifications.....	6
Features.....	7
Chapter 2 - Hardware Installation.....	8
Board Layout.....	8
Block Diagram.....	8
System Memory.....	9
Installing the SODIMM Module.....	10
Installing the Heat Sink.....	11
Jumper Settings.....	11
Clear CMOS.....	11
Auto Power-on Select.....	12
LVDS Panel Power Select.....	12
LCD/Inverter Power Select.....	13
LVDS Backlight Power Select.....	13
eDP Panel Power Select (Optional).....	14
eDP Inverter Power Select (Optional).....	14
eDP Backlight Power Select (Optional).....	15
COM 1 RS232/Power Select.....	15
Rear Panel I/O Ports.....	16
12V DC-in (KU171)/9~36V DC-in (KU173).....	16
Graphics Interfaces.....	17
RJ45 LAN Ports.....	17
USB Ports.....	18
Audio.....	19
I/O Connectors.....	19

Digital I/O and Power Connectors.....	19
SATA (Serial ATA) Connectors.....	20
SATA (Serial ATA) Power Connectors.....	20
COM (Serial) Ports.....	21
Front Panel Connector.....	22
Cooling Fan Connectors.....	22
LVDS LCD Panel Connector.....	23
LCD/Inverter Power Connector.....	23
S/PDIF Connector.....	24
SMBus Connector.....	24
Expansion Slots.....	25
Chassis Intrusion Connector.....	25
eDP Connector (Optional).....	26
LPC Connector.....	27
Standby Power LED.....	27
Battery.....	28

Chapter 3 - BIOS Setup.....	29
Overview.....	29
Insyde BIOS Setup Utility.....	30
Main.....	30
Advanced.....	30
Security.....	43
Boot.....	43
Exit.....	44
Updating the BIOS.....	45
Notice: BIOS SPI ROM.....	45
Chapter 4 - Supported Software.....	46
Chapter 5 - RAID.....	54
Chapter 6 - Intel AMT Settings.....	58
Appendix A - Troubleshooting Checklist.....	64

Warranty

1. Warranty does not cover damages or failures that arised from misuse of the product, inability to use the product, unauthorized replacement or alteration of components and product specifications.
2. The warranty is void if the product has been subjected to physical abuse, improper installation, modification, accidents or unauthorized repair of the product.
3. Unless otherwise instructed in this user's manual, the user may not, under any circumstances, attempt to perform service, adjustments or repairs on the product, whether in or out of warranty. It must be returned to the purchase point, factory or authorized service agency for all such work.
4. We will not be liable for any indirect, special, incidental or consequential damages to the product that has been modified or altered.

Static Electricity Precautions

It is quite easy to inadvertently damage your PC, system board, components or devices even before installing them in your system unit. Static electrical discharge can damage computer components without causing any signs of physical damage. You must take extra care in handling them to ensure against electrostatic build-up.

1. To prevent electrostatic build-up, leave the system board in its anti-static bag until you are ready to install it.
2. Wear an antistatic wrist strap.
3. Do all preparation work on a static-free surface.
4. Hold the device only by its edges. Be careful not to touch any of the components, contacts or connections.
5. Avoid touching the pins or contacts on all modules and connectors. Hold modules or connectors by their ends.



Important:

Electrostatic discharge (ESD) can damage your processor, disk drive and other components. Perform the upgrade instruction procedures described at an ESD workstation only. If such a station is not available, you can provide some ESD protection by wearing an antistatic wrist strap and attaching it to a metal part of the system chassis. If a wrist strap is unavailable, establish and maintain contact with the system chassis throughout any procedures requiring ESD protection.

Safety Measures

To avoid damage to the system:

- Use the correct AC input voltage range.

To reduce the risk of electric shock:

- Unplug the power cord before removing the system chassis cover for installation or servicing. After installation or servicing, cover the system chassis before plugging the power cord.

About the Package

The package contains the following items. If any of these items are missing or damaged, please contact your dealer or sales representative for assistance.

- One KU171/KU173 motherboard
- One COM port cable (Length: 250mm, 1 x COM port)
- One Serial ATA data with power cable (Length: 300mm)
- One Heat sink (Height: 25mm)

The board and accessories in the package may not come similar to the information listed above. This may differ in accordance to the sales region or models in which it was sold. For more information about the standard package in your region, please contact your dealer or sales representative.

Optional Items

- USB 2.0 port cable (Length: 200mm)
- COM port cable (Length: 250mm, 1 x COM port)
- Serial ATA data with power cable (Length: 300mm)
- Power adapter (100W, 12V, Level 6)
- Power adapter (120W, 19V)
- I/O shield
- Heat sink (Height: 32mm)

The board and accessories in the package may not come similar to the information listed above. This may differ in accordance to the sales region or models in which it was sold. For more information about the standard package in your region, please contact your dealer or sales representative.

Before Using the System Board

Before using the system board, prepare basic system components.

If you are installing the system board in a new system, you will need at least the following internal components.

- Memory module
- Storage devices such as hard disk drive, etc.

You will also need external system peripherals you intend to use which will normally include at least a keyboard, a mouse and a video display monitor.

Chapter 1 - Introduction

Specifications

SYSTEM	Processor	7th Generation Intel® Core™ Processors, BGA 1356 Socket Intel® Core™ i7-7600U Processor, Dual Core, 4M Cache, 2.80 GHz (3.90 GHz), 15W Intel® Core™ i5-7300U Processor, Dual Core, 3M Cache, 2.60 GHz (3.50 GHz), 15W Intel® Core™ i3-7100U Processor, Dual Core, 3M Cache, 2.40 GHz, 15W Intel® Celeron® Processor 3965U, Dual Core, 2M Cache, 2.20 GHz, 15W
	Memory	Two 260-pin SODIMM up to 32GB Dual Channel DDR4 1866/2133 MHz
	BIOS	Insyde SPI 128Mbit
GRAPHICS	Controller	Intel® HD Graphics GT Series
	Feature	OpenGL 4.4, DirectX 12, OpenCL 2.1 HW Decode: AVC/H.264, MPEG2, VC1/WMV9, JPEG/MJPEG, HEVC/H265, VP8, VP9 HW Encode: AVC/H.264, MPEG2, JPEG, HEVC/H265, VP8, VP9
	Display	1 x LVDS/eDP (eDP available upon request) 2 x DP++ LVDS: dual channel 48-bit, resolution up to 1920x1200 @ 60Hz DP: resolution up to 4096x2304 @ 60Hz eDP: resolution up to 4096x2304 @ 60Hz
	Triple Displays	LVDS + DP++ + DP++ eDP + DP++ + DP++
EXPANSION	Interface	1 x PCIe x4 (Gen 3) 1 x Full-size Mini PCIe (PCIe/USB) 1 x M.2 M Key (2242/2260/2280) (PCIe/SATA)
AUDIO	Audio Codec	Realtek ALC888S-VD2-GR
ETHERNET	Controller	1 x Intel® I210AT PCIe (10/100/1000Mbps) 1 x Intel® I219LM PCIe with iAMT11.6 (10/100/1000Mbps) (only Core i7/i5 supports iAMT)
REAR I/O	Ethernet	2 x GbE (RJ-45)
	USB	4 x USB 3.0
	Display	2 x DP++
	Audio	1 x Line-out 1 x Mic-in
INTERNAL I/O	Serial	1 x RS-232/422/485 (RS-232 w/ power) (2.0mm pitch) 1 x RS-232 (2.0mm pitch) Note: The internal RS232 extension cable should not exceed 10cm in length.
	USB	4 x USB 2.0 (2.0mm pitch)
	Display	1 x LVDS LCD Panel Connector 1 x LCD/Inverter Power 1 x eDP LCD Panel Connector (available upon request)

	Audio	1 x S/PDIF
	SATA	2 x SATA 3.0 (up to 6Gb/s) 2 x SATA Power RAID 0/1/5
	DIO	1 x 8-bit DIO
	LPC	1 x LPC
	SMBus	1 x SMBus
WATCHDOG TIMER	Output & Interval	System Reset, Programmable via Software from 1 to 255 Seconds
SECURITY	TPM	Available Upon Request
POWER	Type	Single 12V +/-10% DC (KU171) Wide Range 9~36V (KU173)
	Connector	DC-in Jack Right Angle Connector (4-pin) (available upon request) Vertical Type Connector (4-pin) (available upon request)
	RTC Battery	CR2032 Coin Cell
OS SUPPORT	Microsoft /Linux	Windows 10 IoT Enterprise 64-bit Debian 8 (with VESA graphic driver) CentOS 7 (with VESA graphic driver) Ubuntu 15.10 (Intel graphic driver available)
ENVIRONMENT	Temperature	Operating: 0 to 60°C / -20 to 70°C Storage: -40 to 85°C
	Humidity	Operating: 5 to 90% RH Storage: 5 to 90% RH
	MTBF	KU171 : 433,836 hrs @ 25°C; 252,953 hrs @ 45°C; 161,770 hrs @ 60°C KU173 : 416,214 hrs @ 25°C; 241,863 hrs @ 45°C; 154,716 hrs @ 60°C Calculation model: Telcordia Issue 2 Environment: GB, GC – Ground Benign, Controlled
MECHANICAL	Dimensions	Mini-ITX Form Factor 170mm (6.7") x 170mm (6.7")
	Height	PCB: 1.6mm Top Side: 16.5mm Bottom Side: 3.5mm

Features

- **Watchdog Timer**

The Watchdog Timer function allows your application to regularly “clear” the system at the set time interval. If the system hangs or fails to function, it will reset at the set time interval so that your system will continue to operate.

- **DDR4**

DDR4 delivers increased system bandwidth and improves performance. The advantages of DDR4 provide an extended battery life and improve the performance at a lower power than DDR3/DDR2.

- **Graphics**

The integrated Intel® HD graphics engine delivers an excellent blend of graphics performance and features to meet business needs. It provides excellent video and 3D graphics with outstanding graphics responsiveness. These enhancements deliver the performance and compatibility needed for today's and tomorrow's business applications. Supports 1 LVDS/eDP (eDP available upon request) and 2 DP++ interfaces for triple display outputs.

- **PCI Express**

PCI Express is a high bandwidth I/O infrastructure that possesses the ability to scale speeds by forming multiple lanes.

- **Serial ATA**

Serial ATA is a storage interface that is compliant with SATA 1.0a specification. With speed of up to 6Gb/s (SATA 3.0), it improves hard drive performance faster than the standard parallel ATA whose data transfer rate is 100MB/s.

- **Gigabit LAN**

Intel® I210AT PCI Express Gigabit Ethernet and Intel® I219LM with iAMT11.6 Gigabit Ethernet Phy controllers support up to 1Gbps data transmission.

- **Audio**

The Realtek ALC888S-VD2-GR audio codec provides 7.1+2 channel High Definition audio output.

- **Wake-On-LAN**

This feature allows the network to remotely wake up a Soft Power Down (Soft-Off) PC. It is supported via the onboard LAN port or via a PCI LAN card that uses the PCI PME (Power Management Event) signal. However, if your system is in the Suspend mode, you can power-on the system only through an IRQ or DMA interrupt.

- **Wake-On-USB (optional)**

This function allows you to use a USB keyboard or USB mouse to wake up a system from the S3 (STR - Suspend To RAM) state.

- **ACPI STR**

The system board is designed to meet the ACPI (Advanced Configuration and Power Interface) specification. ACPI has energy saving features that enables PCs to implement Power Management and Plug-and-Play with operating systems that support OS Direct Power Management. ACPI when enabled in the Power Management Setup will allow you to use the Suspend to RAM function.

With the Suspend to RAM function enabled, you can power-off the system at once by pressing the power button or selecting “Standby” when you shut down Windows® without having to go through the sometimes tiresome process of closing files, applications and operating system. This is because the system is capable of storing all programs and data files during the entire operating session into RAM (Random Access Memory) when it powers-off. The operating session will resume exactly where you left off the next time you power-on the system.

- **RTC Timer**

The RTC installed on the system board allows your system to automatically power-on on the set date and time.

- **Power Failure Recovery**

When power returns after an AC power failure, you may choose to either power-on the system manually or let the system power-on automatically.

- **USB**

The system board supports the new USB 3.0. It is capable of running at a maximum transmission speed of up to 5 Gbit/s (625 MB/s) and is faster than USB 2.0 (480 Mbit/s, or 60 MB/s) and USB 1.1 (12Mb/s). USB 3.0 reduces the time required for data transmission, reduces power consumption, and is backward compatible with USB 2.0. It is a marked improvement in device transfer speeds between your computer and a wide range of simultaneously accessible external Plug and Play peripherals.

Chapter 2 - Hardware Installation

Board Layout

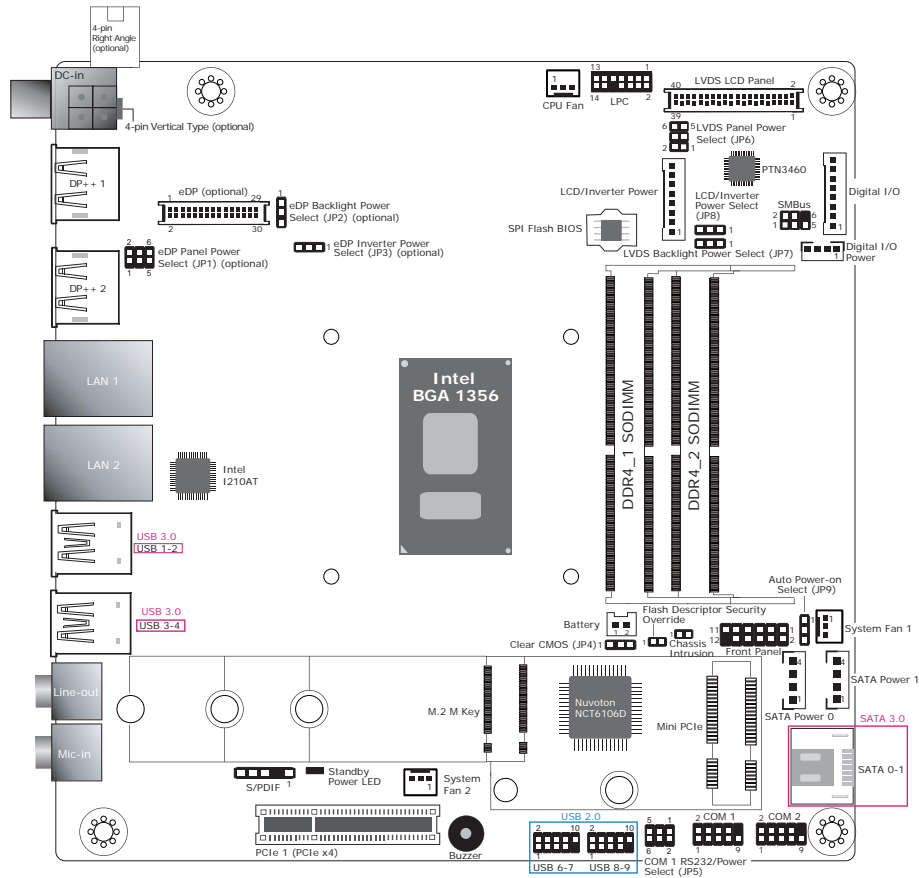

- KU171: Single 12V +/-10% DC
KU173: Wide Range 9~36V
- The eDP connector is optional. Please contact your sales representative for more information.
- JP1, JP2 and JP3 will work when the eDP connector is populated on the system board.

Block Diagram

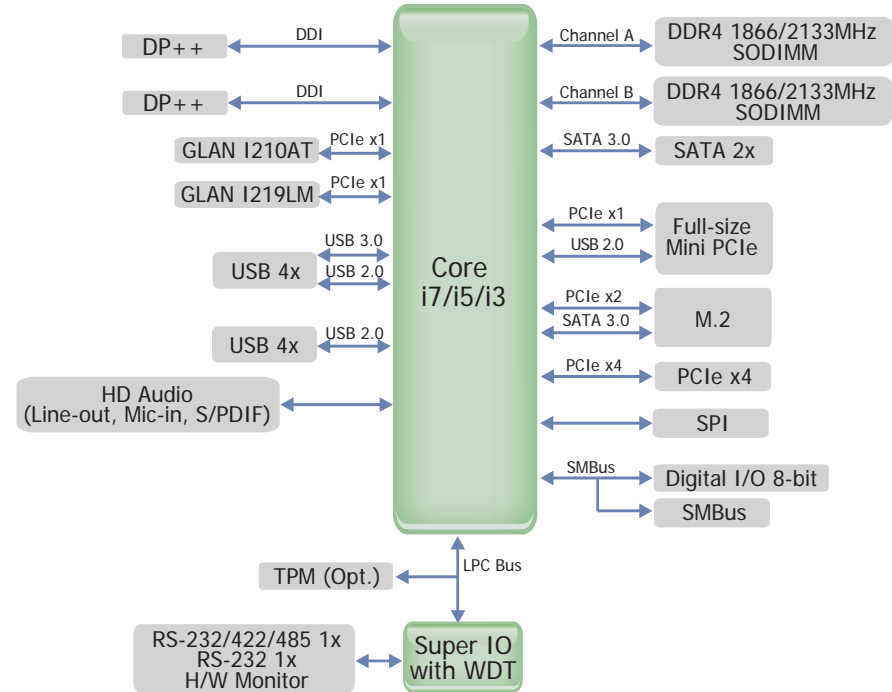

**Important:**

Electrostatic discharge (ESD) can damage your board, processor, disk drives, add-in boards, and other components. Perform installation procedures at an ESD workstation only. If such a station is not available, you can provide some ESD protection by wearing an antistatic wrist strap and attaching it to a metal part of the system chassis. If a wrist strap is unavailable, establish and maintain contact with the system chassis throughout any procedures requiring ESD protection.

System Memory

**Important:**

When the Standby Power LED lights red, it indicates that there is power on the system board. Power-off the PC then unplug the power cord prior to installing any devices. Failure to do so will cause severe damage to the motherboard and components.

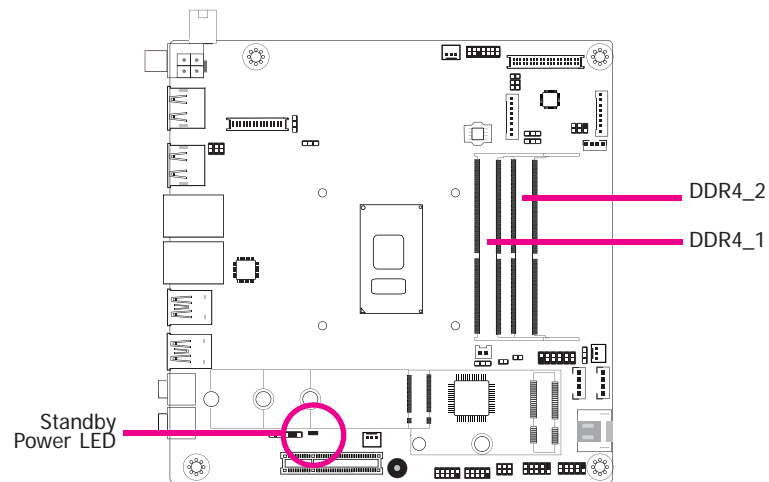

The system board supports the following memory interface.

Single Channel (SC)

Data will be accessed in chunks of 64 bits (8B) from the memory channels.

Dual Channel (DC)

Data will be accessed in chunks of 128 bits from the memory channels. Dual channel provides better system performance because it doubles the data transfer rate.

Single Channel

DIMMs are on the same channel.
DIMMs in a channel can be identical or completely different. However, we highly recommend using identical DIMMs.
Not all slots need to be populated.

Dual Channel

DIMMs of the same memory configuration are on different channels.

Features

- Two 260-pin SODIMM up to 32GB
- Dual Channel DDR4 1866/2133MHz

Installing the SODIMM Module



Note:

The system board used in the following illustrations may not resemble the actual board. These illustrations are for reference only.

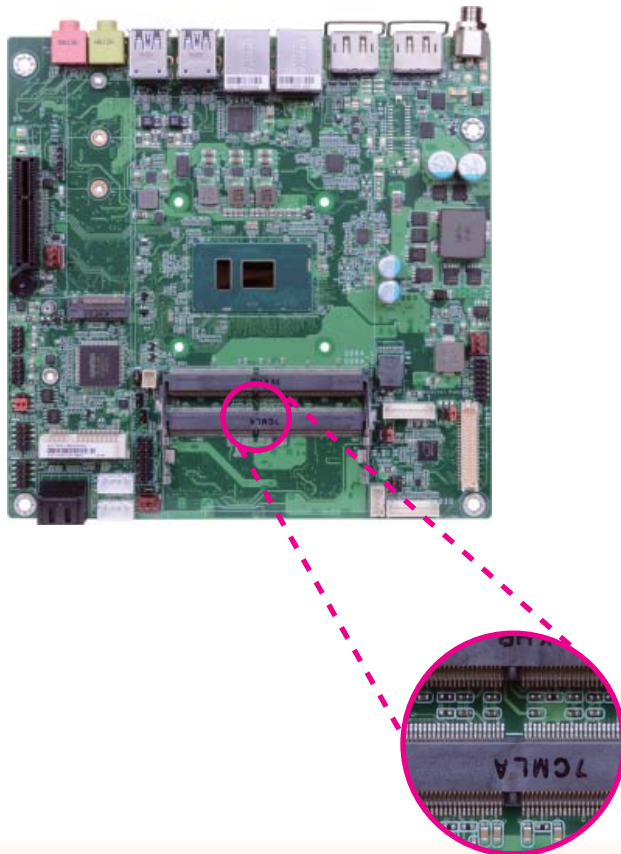
1. Make sure the PC and all other peripheral devices connected to it has been powered down.
2. Disconnect all power cords and cables.
3. Locate the SODIMM socket on the system board.
4. Note the key on the socket. The key ensures the module can be plugged into the socket in only one direction.

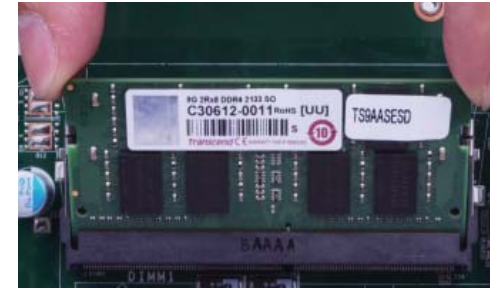

5. Grasping the module by its edges, align the module into the socket at an approximately 30 degrees angle. Apply firm even pressure to each end of the module until it slips down into the socket. The contact fingers on the edge of the module will almost completely disappear inside the socket.



6. Push down the module until the clips at each end of the socket lock into position. You will hear a distinctive "click", indicating the module is correctly locked into position.



Installing the Heat Sink

The CPU must be kept cool by using a CPU fan with heat sink. Without sufficient air circulation across the CPU and heat sink, the CPU will overheat damaging both the CPU and system board.

1. Apply a thin layer of thermal paste on top of the heat sink. Do not spread the paste all over the surface. When you later place the heat sink on top of the CPU, the compound will disperse evenly.
2. Place the heat sink assembly on top of the CPU. The 4 screws around the heat sink must match the mounting holes. We strongly recommend using this type of heat sink assembly because it provides adequate cooling to the components of the system board.

Turn each Phillips head screw half way down first to initially stabilize the heat sink onto the board, then finally tighten each screw.



Important:

Do not turn the first screw all the way down followed by the next and so on. This is to avoid imbalance which might cause cracks or fractures to the CPU and/or heat sink assembly.

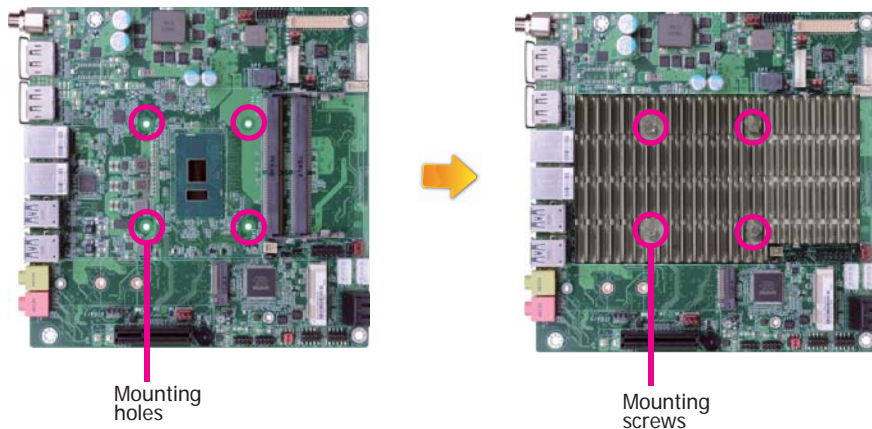

Jumper Settings

Clear CMOS

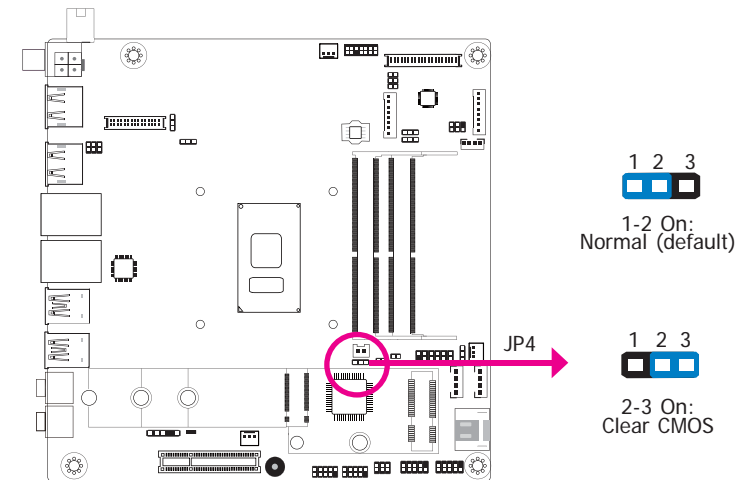

If you encounter the following,

- a) CMOS data becomes corrupted.
- b) You forgot the supervisor or user password.

you can reconfigure the system with the default values stored in the ROM BIOS.

To load the default values stored in the ROM BIOS, please follow the steps below.

1. Power-off the system and unplug the power cord.
2. Set JP4 pins 2 and 3 to On. Wait for a few seconds and set JP4 back to its default setting, pins 1 and 2 On.
3. Now plug the power cord and power-on the system.

Auto Power-on Select

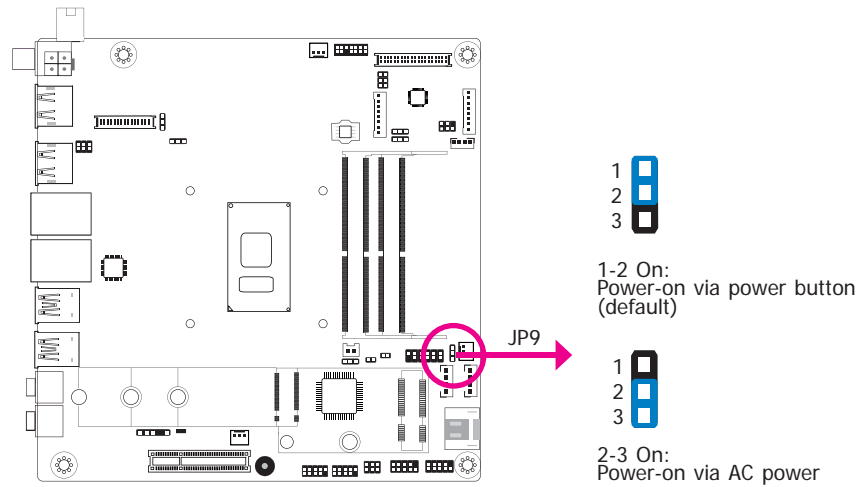

JP9 is used to select the method of powering on the system. If you want the system to power-on whenever AC power comes in, set JP9 pins 2 and 3 to On. If you want to use the power button, set pins 1 and 2 to On.

When using the JP9 “Power On” feature to power the system back on after a power failure occurs, the system may not power on if the power lost is resumed within 5 seconds (power flicker).

LVDS Panel Power Select

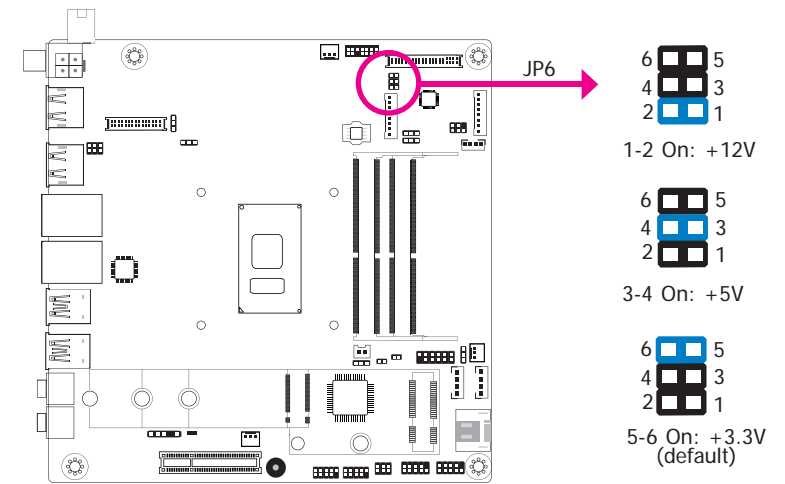

JP6 is used to select the power supplied with the LVDS LCD panel.

**Important:**

Before powering-on the system, make sure that the power settings of JP6 match the LCD panel's specification. Selecting the incorrect voltage will seriously damage the LCD panel.

LCD/Inverter Power Select

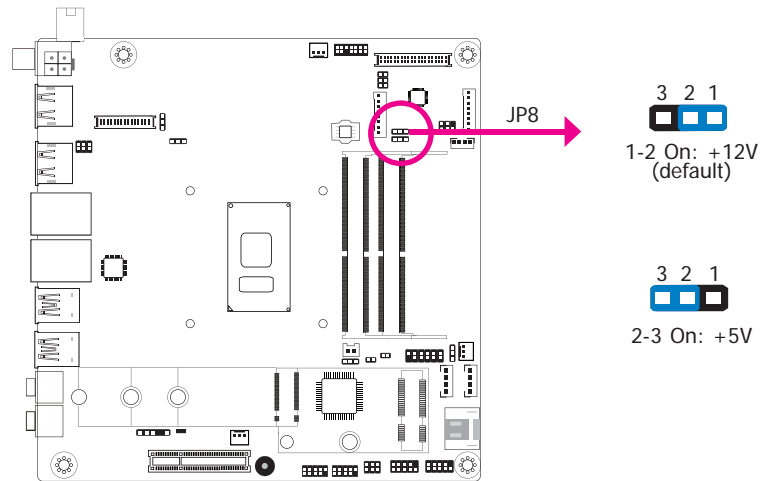

JP8 is used to select the power level of the LCD/Inverter power connector.

LVDS Backlight Power Select

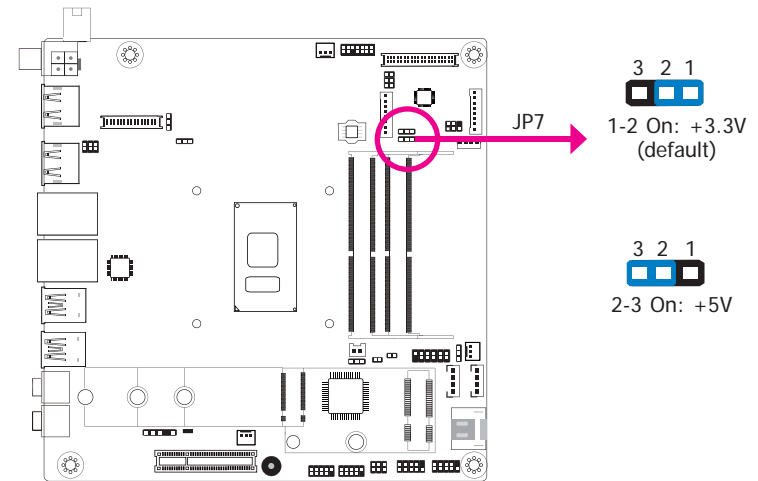

JP7 is used to select the power level of backlight control: +3.3V (default) or +5V.

**Important:**

Before powering-on the system, make sure that the power settings of JP7 match the power specification of backlight control. Selecting the incorrect voltage will seriously damage the backlight.

eDP Panel Power Select (Optional)

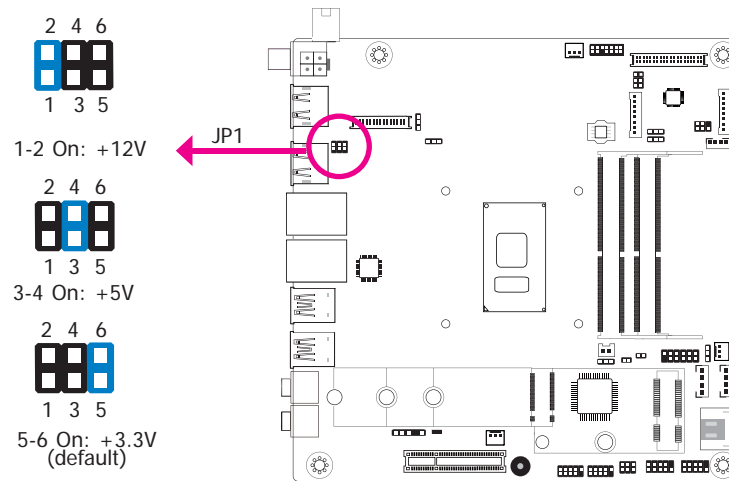

JP1 is used to select the power supplied with the eDP panel.

**Important:**

Before powering-on the system, make sure that the power settings of JP1 match the eDP panel's specification. Selecting the incorrect voltage will seriously damage the eDP panel.

eDP Inverter Power Select (Optional)

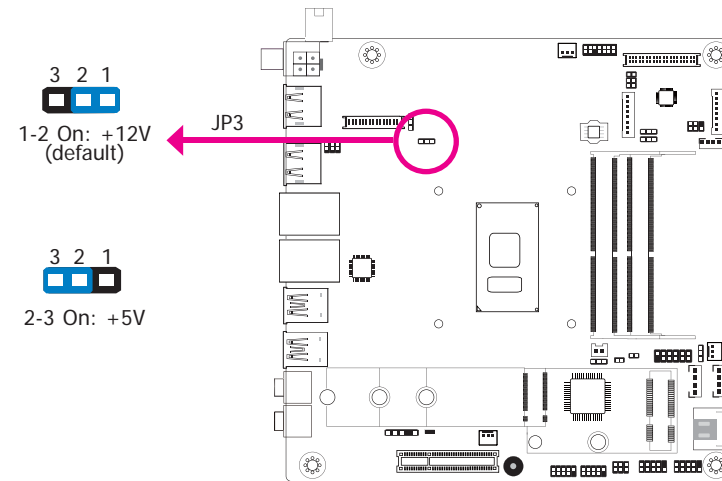

JP3 is used to select the power level of the eDP Inverter power supply.

eDP Backlight Power Select (Optional)

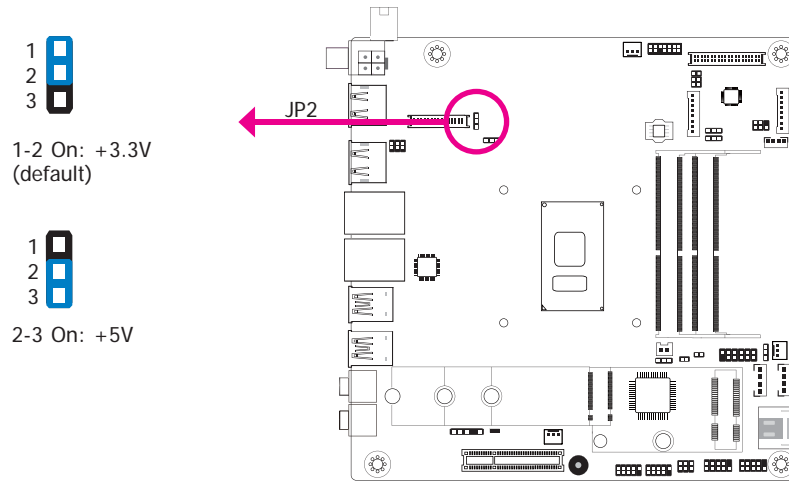

JP2 is used to select the power level of backlight control: +3.3V (default) or +5V.



Important:

Before powering-on the system, make sure that the power settings of JP2 match the power specification of backlight control. Selecting the incorrect voltage will seriously damage the backlight.

COM 1 RS232/Power Select

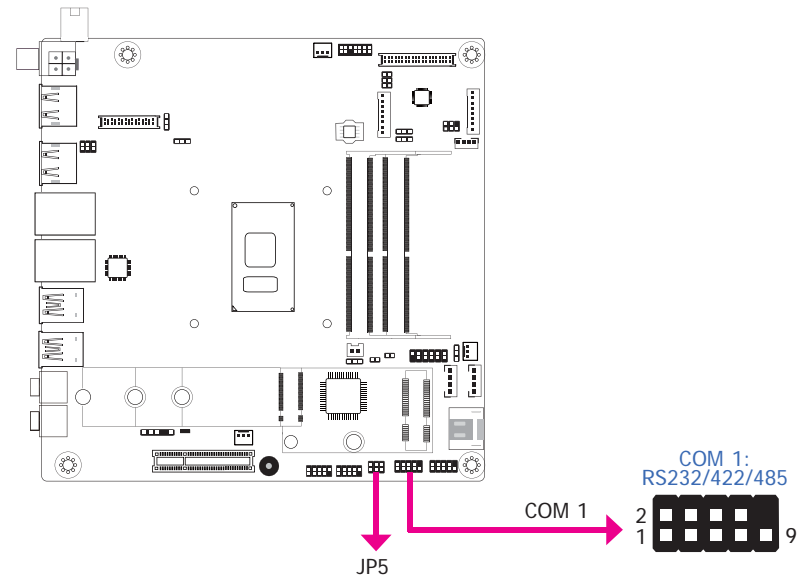

JP5 is designed to configure the Serial COM port 1 to pure RS232 or RS232 with power. The pin functions of COM 1 will vary according to JP5's setting.

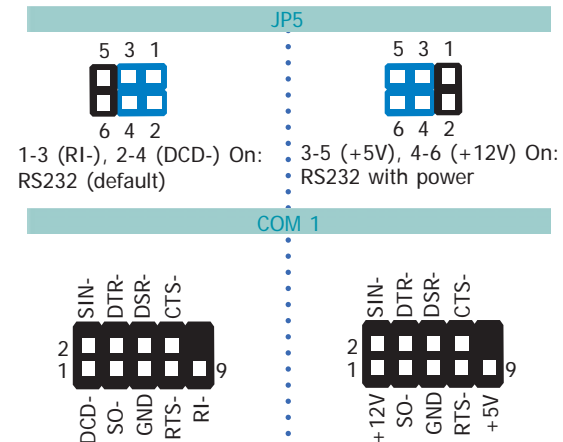

Rear Panel I/O Ports

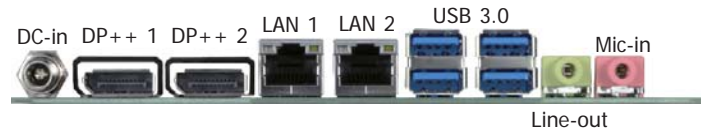

The rear panel I/O ports consist of the following:

- 1 12V DC-in jack (default) - KU171
- 1 9~36V DC-in jack (default) - KU173
- 2 DP++ ports
- 2 RJ45 LAN ports
- 4 USB 3.0 ports
- 1 Line-out jack
- 1 Mic-in jack

12V DC-in (KU171)/9~36V DC-in (KU173)

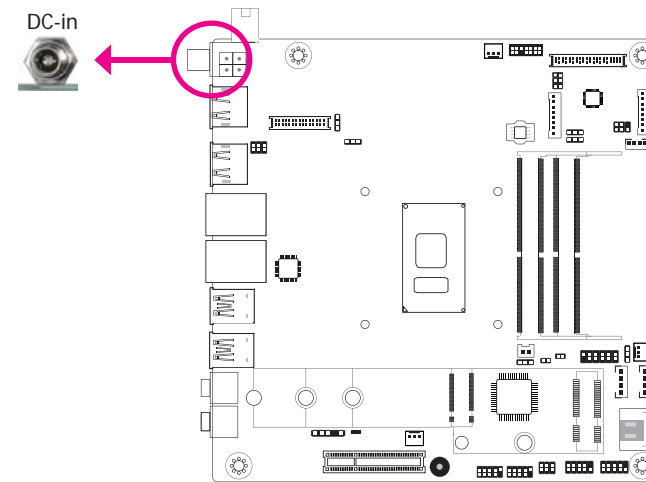

Connect a DC power cord to the DC-in jack. Using a voltage more than the recommended range may fail to boot the system or cause damage to the system board.

The DC-in jack on the system board co-lays with a 4-pin right angle connector (optional) or 4-pin vertical type connector (optional) as the photo displayed below.



Graphics Interfaces

The display ports consist of the following:

- 2 DP++ ports

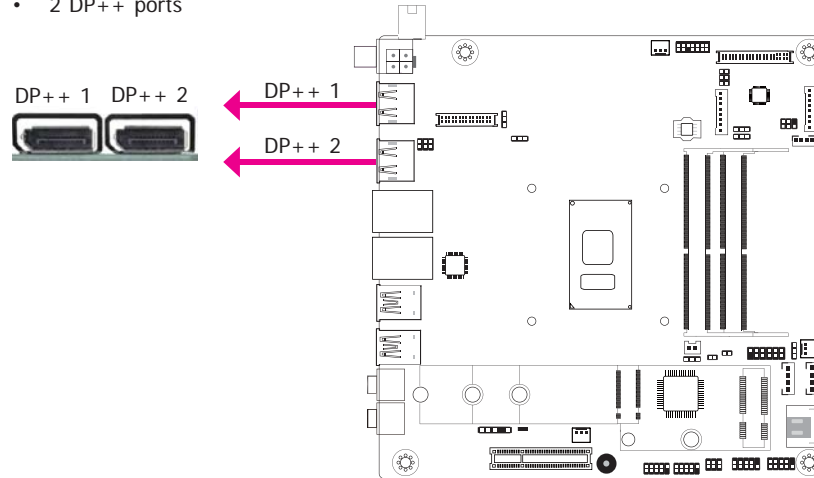

DP++ Port

The DP++ port is a digital display interface used to connect a display device such as a computer monitor. It is used to transmit audio and video simultaneously. The interface, which is developed by VESA, delivers higher performance features than any other digital interface.

BIOS Setting

Configure the display devices in the Advanced menu ("Video Configuration" submenu) of the BIOS. Refer to chapter 3 for more information.

Driver Installation

Install the graphics driver. Refer to chapter 4 for more information.

RJ45 LAN Ports

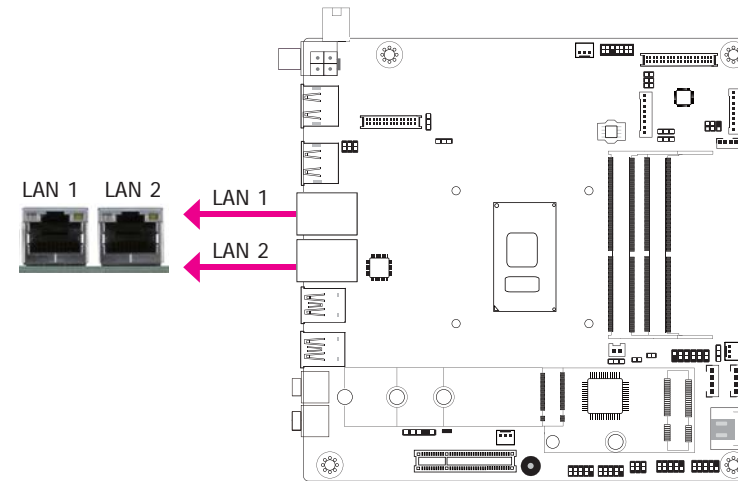

Features

- Intel® I210AT PCIe (10/100/1000Mbps)
- Intel® I219LM PCIe with iAMT11.6 (10/100/1000Mbps) (only Core i7/i5 supports iAMT)

The LAN ports allow the system board to connect to a local area network by means of a network hub.

BIOS Setting

Configure the onboard LAN ports in the Advanced menu ("ACPI Configuration" submenu) of the BIOS. Refer to chapter 3 for more information.

Driver Installation

Install the LAN drivers. Refer to chapter 4 for more information.

USB Ports

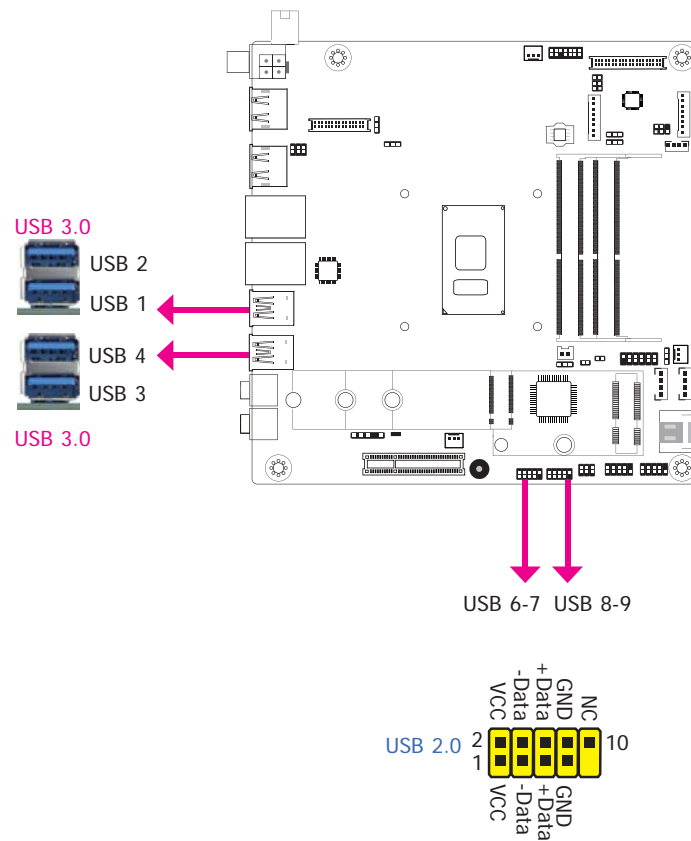

The USB device allows data exchange between your computer and a wide range of simultaneously accessible external Plug and Play peripherals.

The system board is equipped with four onboard USB 3.0 ports (USB 1-2/3-4). The 10-pin connectors allow you to connect 4 additional USB 2.0 ports (USB 6-7/8-9). The additional USB ports may be mounted on a card-edge bracket. Install the card-edge bracket to an available slot at the rear of the system chassis and then insert the USB port cables to a connector.

BIOS Setting

Configure the onboard USB in the Advanced menu ("USB Configuration" submenu) of the BIOS. Refer to chapter 3 for more information.

Driver Installation

You may need to install the proper drivers in your operating system to use the USB device. Refer to your operating system's manual or documentation for more information.

Wake-On-USB Keyboard/Mouse

The Wake-On-USB Keyboard/Mouse function allows you to use a USB keyboard or USB mouse to wake up a system from the S3 (STR - Suspend To RAM) state.

Audio

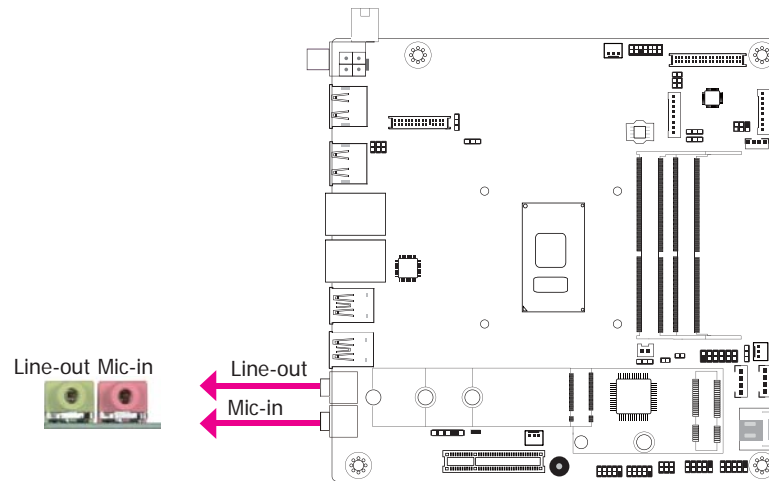

Rear Audio

The system board is equipped with 2 audio jacks. A jack is a one-hole connecting interface for inserting a plug.

- Line-out Jack (Lime)
This jack is used to connect a headphone or external speakers.
- Mic-in (Pink)
This jack is used to connect an external microphone.

BIOS Setting

Configure the onboard audio devices in the Advanced menu ("Audio Configuration" submenu) of the BIOS. Refer to chapter 3 for more information.

Driver Installation

Install the audio driver. Refer to the chapter 4 for more information.

I/O Connectors

Digital I/O Connector

Digital I/O Power Connector

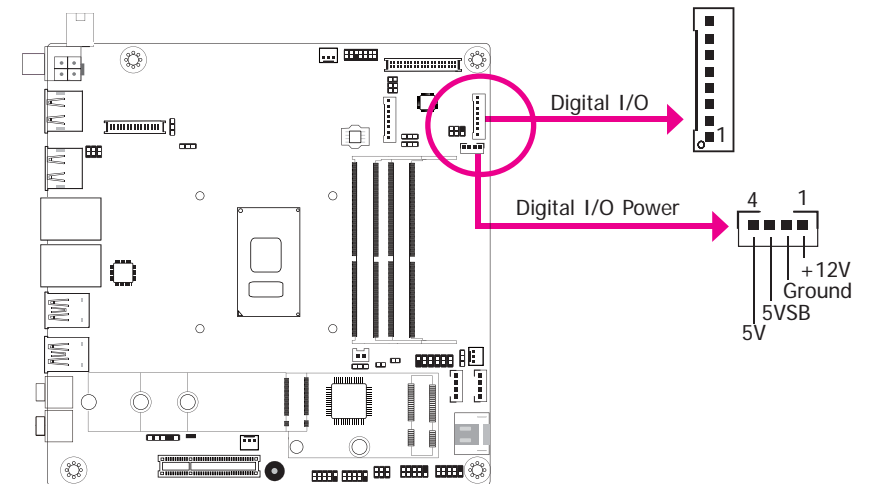

The 8-bit Digital I/O connector provides powering-on function to external devices that are connected to the connector.

Digital I/O Connector

Pins	Function
1	DIO0
2	DIO1
3	DIO2
4	DIO3
5	DIO4
6	DIO5
7	DIO6
8	DIO7

SATA (Serial ATA) Connectors

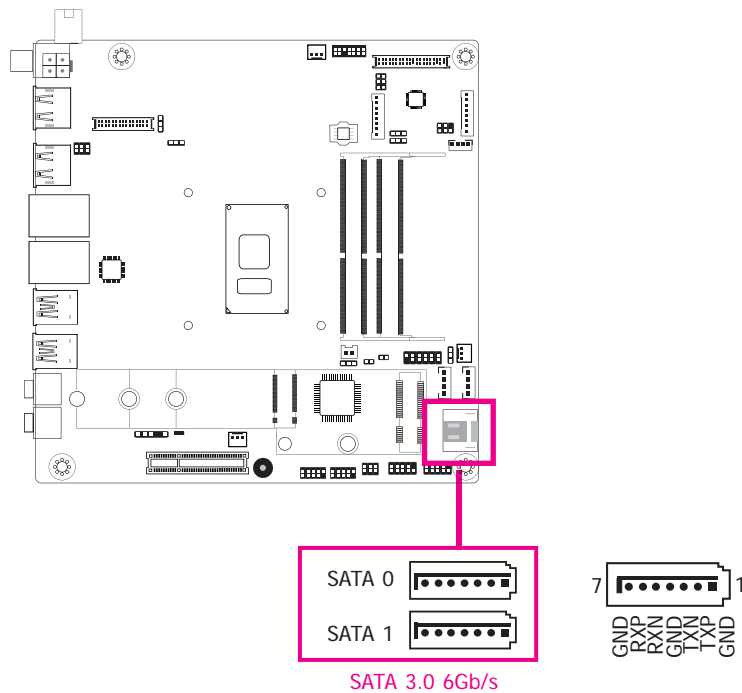

SATA (Serial ATA) Power Connectors

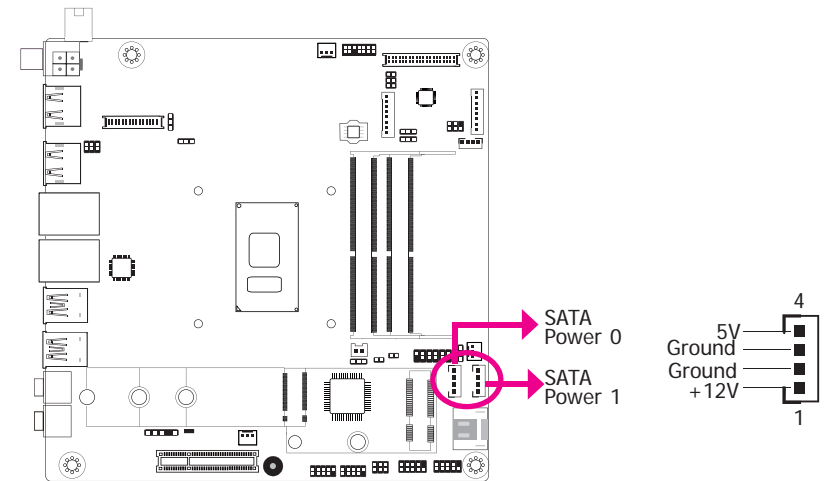

These SATA power connectors supply power to the SATA drive. Connect one end of the provided power cable to the SATA power connector and the other end to your storage device.

Features

- 2 Serial ATA 3.0 ports with data transfer rate up to 6Gb/s
- Integrated Advanced Host Controller Interface (AHCI) controller
- Supports RAID 0/1/5

The Serial ATA connectors are used to connect Serial ATA devices. Connect one end of the Serial ATA data cable to a SATA connector and the other end to your Serial ATA device.

BIOS Setting

Configure the Serial ATA drives in the Advanced menu ("SATA Configuration" submenu) of the BIOS. Refer to chapter 3 for more information.

COM (Serial) Ports

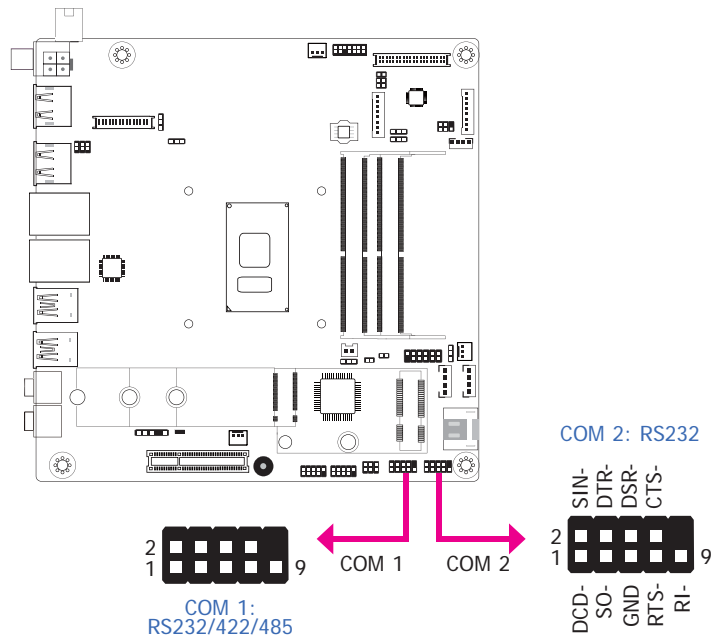

The pin functions of COM 1 will vary according to BIOS' and JP5's settings. COM 1 can be selected among RS232, RS422 and RS485 via BIOS. JP5 is designed to configure Serial COM port 1 to pure RS232 or RS232 with power. Refer to "COM 1 RS232/Power Select" in this chapter for more information.

COM 2 is fixed at RS232.

The serial ports are asynchronous communication ports with 16C550A-compatible UARTs that can be used with modems, serial printers, remote display terminals, and other serial devices.

Note: The internal RS232 extension cable should not exceed 10cm in length.

Connecting External Serial Ports

Your COM port may come mounted on a card-edge bracket. Install the card-edge bracket to an available slot at the rear of the system chassis then insert the serial port cable to the COM connector. Make sure the colored stripe on the ribbon cable is aligned with pin 1 of the COM connector.

BIOS Setting

Configure the serial COM ports in the Advanced menu ("SIO NUVOTON6106D" submenu) of the BIOS. Refer to the chapter 3 for more information.

COM 1 Port Connect

Pin	RS232	RS422 (Full Duplex)	RS485
1	DCD-	RX+	DATA+
2	SIN-	RX-	DATA-
3	SO-	TX+	NC
4	DTR-	TX-	NC
5	GND	GND	GND
6	DSR-	NC	NC
7	RTS-	NC	NC
8	CTS-	NC	NC
9	RI-	NC	NC

Front Panel Connector

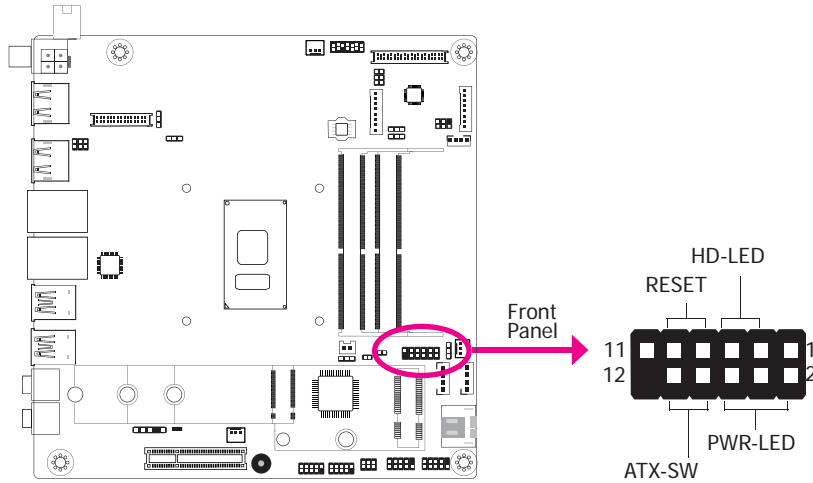

HD-LED - Hard Drive LED

This LED will light when the hard drive is being accessed.

RESET - Reset Switch

This switch allows you to reboot without having to power off the system.

PWR-LED - Power/Standby LED

When the system's power is on, this LED will light. When the system is in the S1 (POS - Power On Suspend) state, it will blink every second. When the system is in the S3 (STR - Suspend To RAM) state, it will blink every 4 seconds.

ATX-SW - Power Switch

This switch is used to power on or off the system.

	Pin	Pin Assignment		Pin	Pin Assignment
	1	N.C.		2	3V3SB
HD-LED	3	3V3	PWR-LED	4	3V3SB
	5	HD_LED		6	Power_LED
RESET	7	Ground	ATX-SW	8	Ground
	9	RST Signal		10	Power_Button
	11	N.C.			

Cooling Fan Connectors

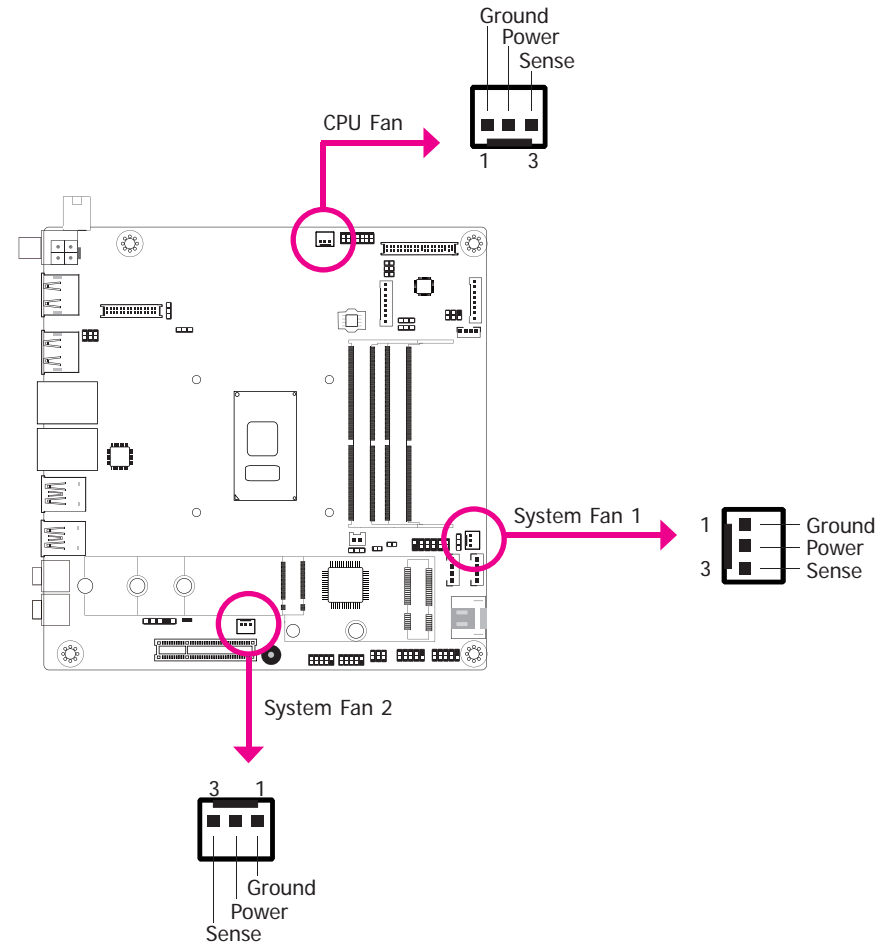

The fan connectors are used to connect cooling fans. The cooling fans will provide adequate airflow throughout the chassis to prevent overheating the CPU and system board components.

BIOS Setting

The Advanced menu ("SIO NUVOTON6106D" submenu) of the BIOS will display the current speed of the cooling fans. Refer to chapter 3 for more information.

LVDS LCD Panel Connector

LCD/Inverter Power Connector

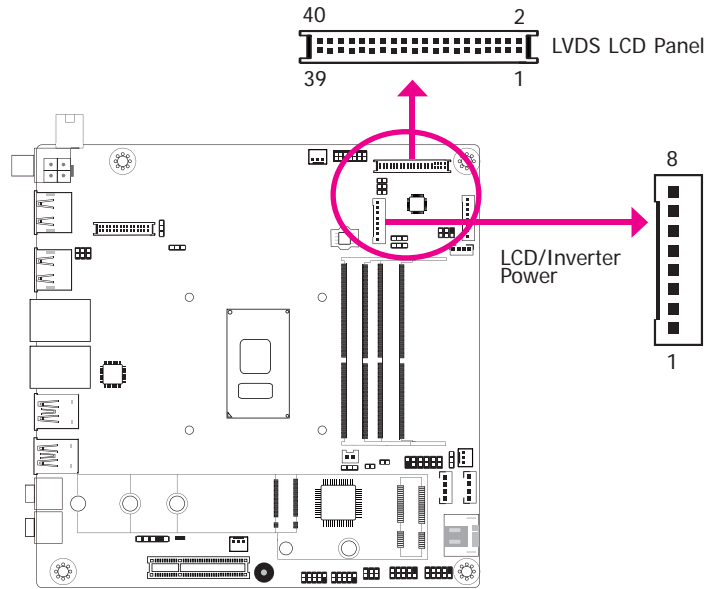

The system board allows you to connect a LCD Display Panel by means of the LVDS LCD panel connector and the LCD/Inverter power connector. These connectors transmit video signals and power from the system board to the LCD Display Panel.

Refer to the right side for the pin functions of these connectors.

Jumper Settings

Refer to the “Jumper Settings” section in this chapter for settings relevant to the LCD panel.

BIOS Setting

Configure the LCD panel in the Advanced menu (“Video Configuration” sub-menu) of the BIOS. Refer to chapter 3 for more information.

LVDS LCD Panel Connector

Pin	Function	Pin	Function
1	GND	2	GND
3	LVDS_Out3+ (Odd_3+)	4	LVDS_Out7+ (Even_3+)
5	LVDS_Out3- (Odd_3-)	6	LVDS_Out7- (Even_3-)
7	GND	8	GND
9	LVDS_Out2+ (Odd_2+)	10	LVDS_Out6+ (Even_2+)
11	LVDS_Out2- (Odd_2-)	12	LVDS_Out6- (Even_2-)
13	GND	14	GND
15	LVDS_Out1+ (Odd_1+)	16	LVDS_Out5+ (Even_1+)
17	LVDS_Out1- (Odd_1-)	18	LVDS_Out5- (Even_1-)
19	GND	20	GND
21	LVDS_Out0+(Odd_0+)	22	LVDS_Out4+ (Even_0+)
23	LVDS_Out0- (Odd_0-)	24	LVDS_Out4- (Even_0-)
25	GND	26	GND
27	LVDS_CLK1+ (Odd_CLK+)	28	LVDS_CLK2+ (Even_CLK+)
29	LVDS_CLK1- (Odd_CLK-)	30	LVDS_CLK2- (Even_CLK-)
31	GND	32	GND
33	LVDS_DDC_CLK	34	N.C.
35	LVDS_DDC_DATA	36	+3.3V
37	Panel Power	38	Panel Power
39	Panel Power	40	Panel Power

LCD/Inverter Power Connector

Pin	Function
1	GND
2	GND
3	Panel Inverter Brightness Voltage Control
4	Panel Power
5	+3.3V
6	Panel Backlight On/Off Control
7	+12V (default)/+5V
8	+12V (default)/+5V



Note:

1. LVDS LCD Panel Connector:
 DFI PN: 346-714000-201S
 Description: HEADER 40P/1.25mm, 180D, SMD, BEIGE, DF13E-40DP-1.25V(51)(Hirose)RoHS

2. LCD/Inverter Power Connector:
 DFI PN: 3346-510801-100G
 Description: BOX HEADER 1*8, 8P/2.0mm/180D, 721-81-08TW00(PINREX)RoHS

S/PDIF Connector

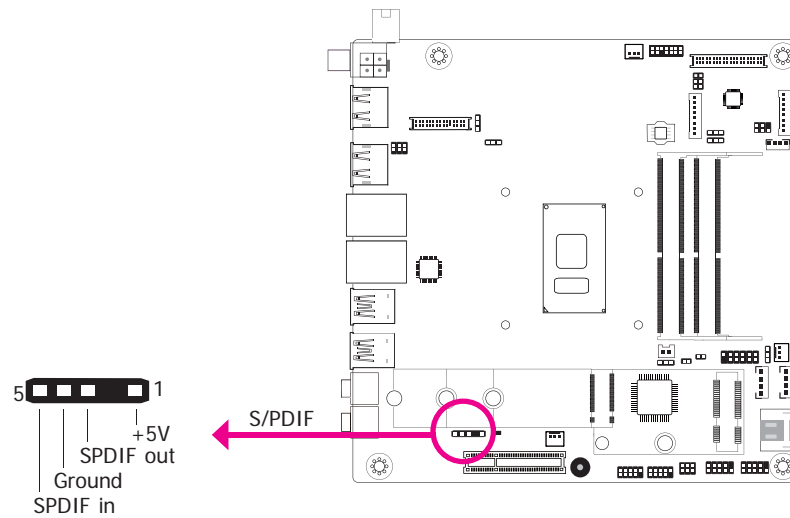

The S/PDIF connector is used to connect an external S/PDIF port. Your S/PDIF port may be mounted on a card-edge bracket. Install the card-edge bracket to an available slot at the rear of the system chassis then connect the audio cable to the S/PDIF connector. Make sure pin 1 of the audio cable is aligned with pin 1 of the S/PDIF connector.

SMBus Connector

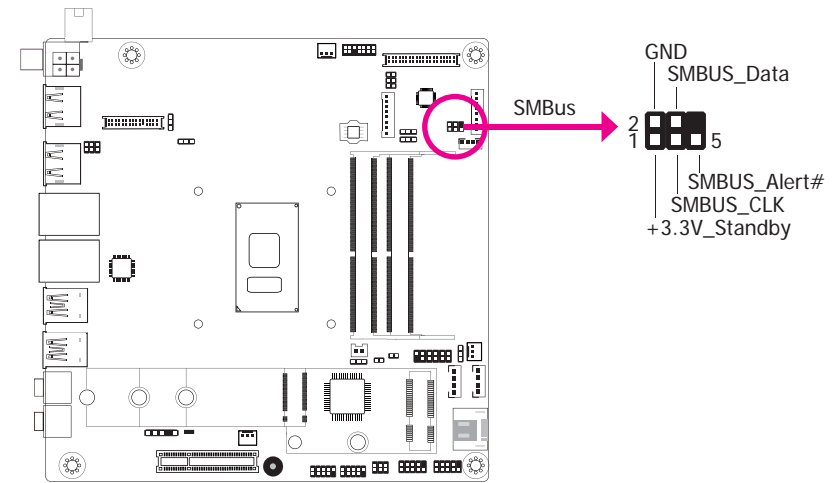

The SMBus (System Management Bus) connector is used to connect SMBus devices. It is a multiple device bus that allows multiple chips to connect to the same bus and enable each one to act as a master by initiating data transfer.

Expansion Slots

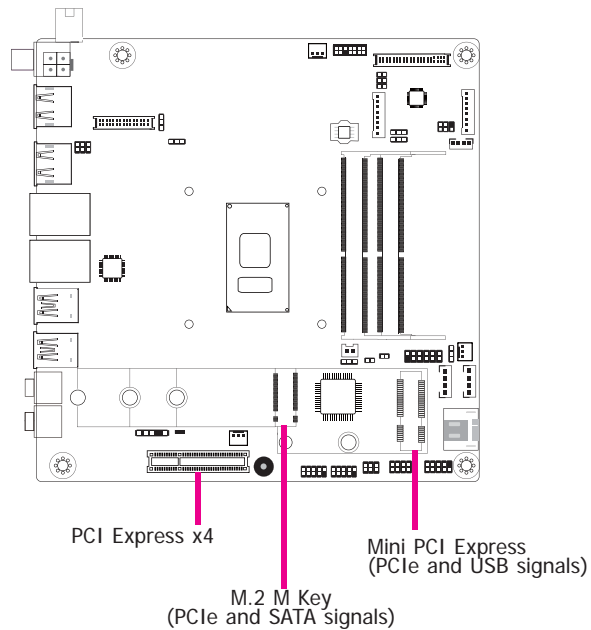

PCI Express x4 Slot

Install PCI Express cards such as network cards or other cards that comply to the PCI Express specifications into the PCI Express x4 slot.

M.2 M Key Socket

The M.2 socket is the Next Generation Form Factor (NGFF) which is designed to support multiple modules and make the M.2 more suitable in application for solid-state storage.

Mini PCI Express Slot

The Mini PCIe socket is used to install a Mini PCIe card. Mini PCIe card is a small form factor PCIe card with the same signal protocol, electrical definitions, and configuration definitions as the conventional PCIe.

Chassis Intrusion Connector

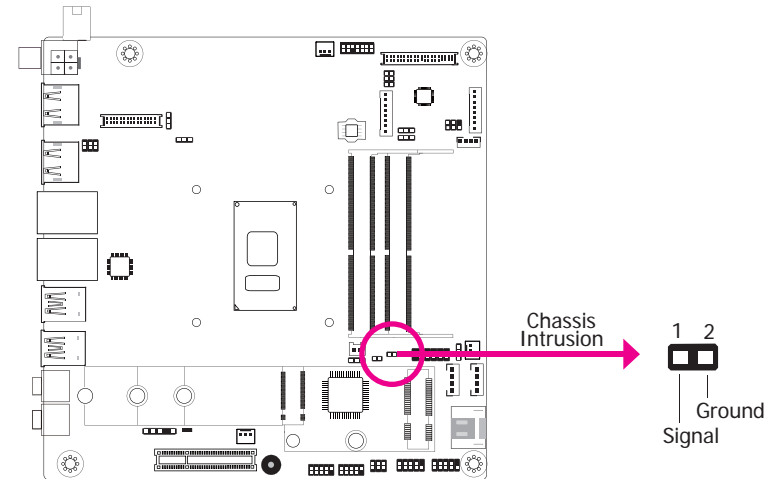

The board supports the chassis intrusion detection function. Connect the chassis intrusion sensor cable from the chassis to this connector. When the system's power is on and a chassis intrusion occurred, an alarm will sound. When the system's power is off and a chassis intrusion occurred, the alarm will sound only when the system restarts.

BIOS Setting

Configure the chassis intrusion detection function in the Advanced menu ("SIO NUVO-TON6106D" submenu) of the BIOS. Refer to the chapter 3 for more information.

eDP Connector (Optional)

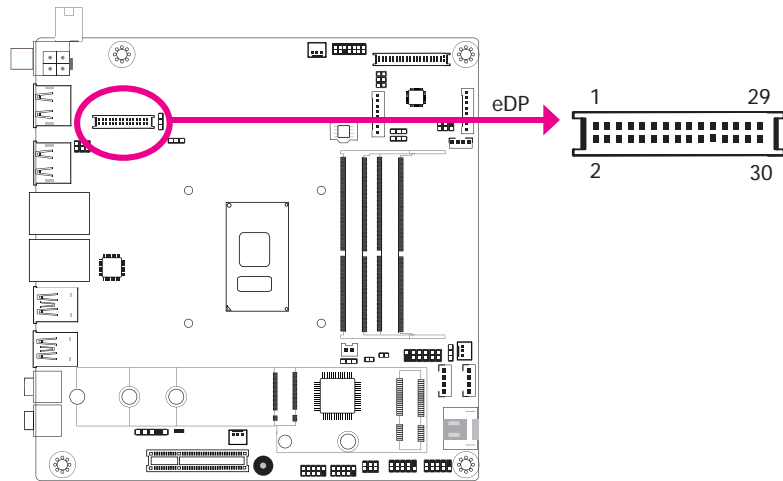

The eDP connector is an embedded displayport which has advanced power-saving features to connect a display device to transmit digital communication of audio and video signals. The table below indicates the pin functions of the eDP connector.

Jumper Settings

Refer to the “Jumper Settings” section in this chapter for settings relevant to the eDP panel.

Pin	Pin Assignment	Pin	Pin Assignment
1	GND	2	GND
3	eDP_Lane 0-	4	eDP_Lane 3-
5	eDP_Lane 0+	6	eDP_Lane 3+
7	GND	8	NC
9	eDP_Lane 1-	10	GND
11	eDP_Lane 1+	12	AUX-
13	GND	14	AUX+
15	eDP_Lane 2-	16	GND
17	eDP_Lane 2+	18	Hot Plug
19	+V_LCD	20	+V_LCD
21	GND	22	GND
23	Panel Backlight On/Off Control	24	Panel Inverter Brightness Voltage Control
25	Inverter GND	26	Inverter GND
27	3V3	28	Inverter PWR
29	Inverter PWR	30	Inverter PWR



Note:

eDP Connector:
DFI PN: 346-713000-201G
Description: HEADER 30P/1.25mm, 180D, SMD, BEIGE, DF13E-30DP-1.25V(51)(Hirose)RoHS

LPC Connector

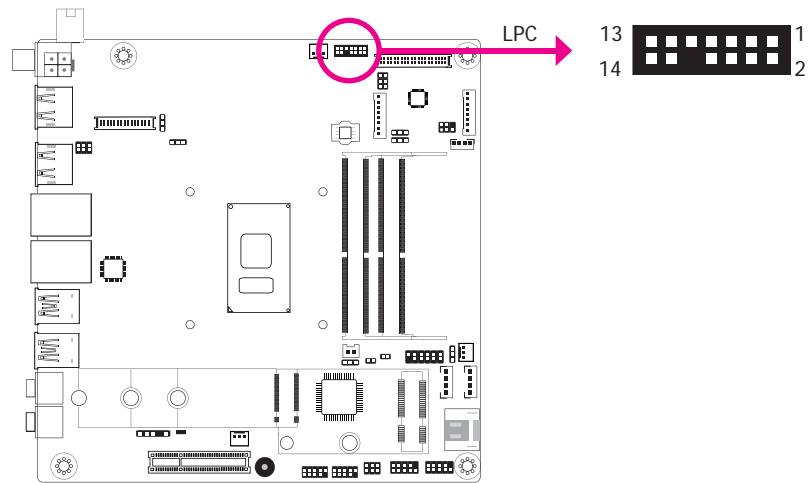

The Low Pin Count Interface was defined by Intel® Corporation to facilitate the industry's transition towards legacy free systems. It allows the integration of low-bandwidth legacy I/O components within the system, which are typically provided by a Super I/O controller. Furthermore, it can be used to interface firmware hubs, Trusted Platform Module (TPM) devices and embedded controller solutions. Data transfer on the LPC bus is implemented over a 4 bit serialized data interface, which uses a 24MHz LPC bus clock. For more information about LPC bus refer to the Intel® Low Pin Count Interface Specification Revision 1.1'. The table below indicates the pin functions of the LPC connector.

Pin	Pin Assignment	Pin	Pin Assignment
1	CLK_24M	2	LAD1
3	RST#	4	LAD0
5	FRAME#	6	VCC3
7	LAD3	8	GND
9	LAD2	10	---
11	SERIRQ	12	GND
13	5VSB	14	5V

Standby Power LED

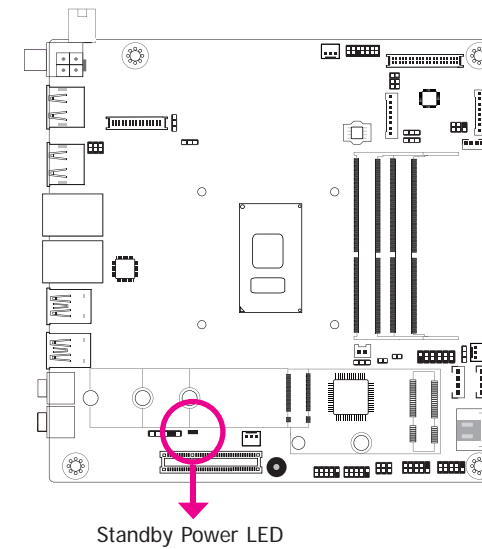

This LED will lit red when the system is in the standby mode. It indicates that there is power on the system board. Power-off the PC and then unplug the power cord prior to installing any devices. Failure to do so will cause severe damage to the motherboard and components.

Battery

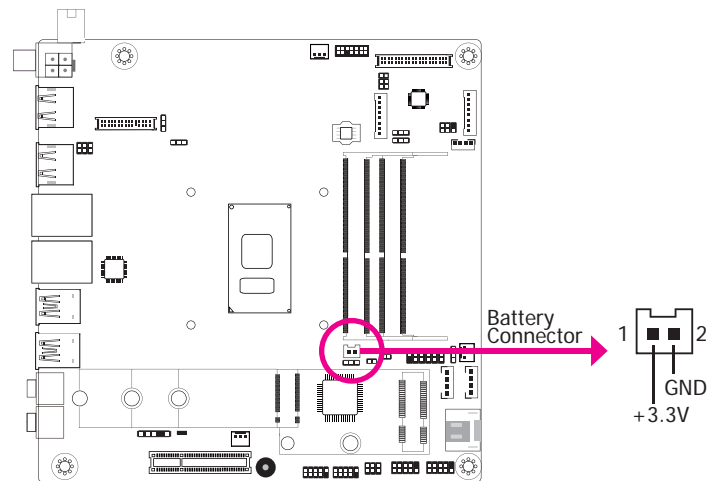

The lithium ion battery powers the real-time clock and CMOS memory. It is an auxiliary source of power when the main power is shut off.

Safety Measures

- Danger of explosion if battery incorrectly replaced.
- Replace only with the same or equivalent type recommended by the manufacturer.
- Dispose of used batteries according to local ordinance.

Chapter 3 - BIOS Setup

Overview

The BIOS is a program that takes care of the basic level of communication between the CPU and peripherals. It contains codes for various advanced features found in this system board. The BIOS allows you to configure the system and save the configuration in a battery-backed CMOS so that the data retains even when the power is off. In general, the information stored in the CMOS RAM of the EEPROM will stay unchanged unless a configuration change has been made such as a hard drive replaced or a device added.

It is possible that the CMOS battery will fail causing CMOS data loss. If this happens, you need to install a new CMOS battery and reconfigure the BIOS settings.



Note:

The BIOS is constantly updated to improve the performance of the system board; therefore the BIOS screens in this chapter may not appear the same as the actual one. These screens are for reference purpose only.

Default Configuration

Most of the configuration settings are either predefined according to the Load Optimal Defaults settings which are stored in the BIOS or are automatically detected and configured without requiring any actions. There are a few settings that you may need to change depending on your system configuration.

Entering the BIOS Setup Utility

The BIOS Setup Utility can only be operated from the keyboard and all commands are keyboard commands. The commands are available at the right side of each setup screen.

The BIOS Setup Utility does not require an operating system to run. After you power up the system, the BIOS message appears on the screen and the memory count begins. After the memory test, the message "Press DEL to run setup" will appear on the screen. If the message disappears before you respond, restart the system or press the "Reset" button. You may also restart the system by pressing the <Ctrl> <Alt> and keys simultaneously.

Legends

Keys	Function
Right and Left arrows	Moves the highlight left or right to select a menu.
Up and Down arrows	Moves the highlight up or down between submenu or fields.
<Esc>	Exit to the BIOS Setup Utility.
<F5>	Scrolls forward through the values or options of the highlighted field.
<F6>	Scrolls backward through the values or options of the highlighted field.
<F1>	Displays general help
<F9>	Optimized defaults
<F10>	Saves and resets the setup program.
<Enter>	Press <Enter> to enter the highlighted submenu.

Scroll Bar

When a scroll bar appears to the right of the setup screen, it indicates that there are more available fields not shown on the screen. Use the up and down arrow keys to scroll through all the available fields.

Submenu

When "►" appears on the left of a particular field, it indicates that a submenu which contains additional options are available for that field. To display the submenu, move the highlight to that field and press <Enter>.

Insyde BIOS Setup Utility

Main

The Main menu is the first screen that you will see when you enter the BIOS Setup Utility.

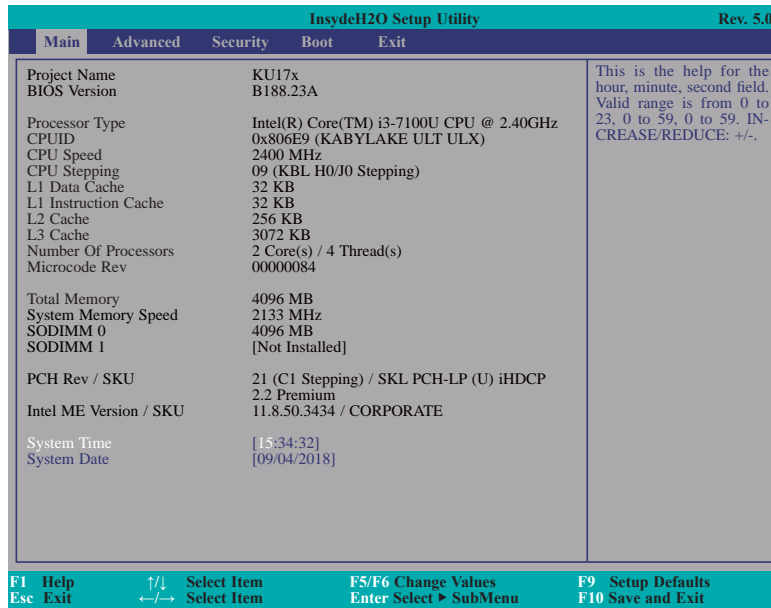

System Time

The time format is <hour>, <minute>, <second>. The time is based on the 24-hour military-time clock. For example, 1 p.m. is 13:00:00. Hour displays hours from 00 to 23. Minute displays minutes from 00 to 59. Second displays seconds from 00 to 59.

System Date

The date format is <month>, <date>, <year>. Month displays the month, from 01 to 12. Date displays the date, from 01 to 31. Year displays the year, from 2000 to 2099.

Advanced

The Advanced menu allows you to configure your system for basic operation. Some entries are defaults required by the system board, while others, if enabled, will improve the performance of your system or let you set some features according to your preference.



Important:

Setting incorrect field values may cause the system to malfunction.

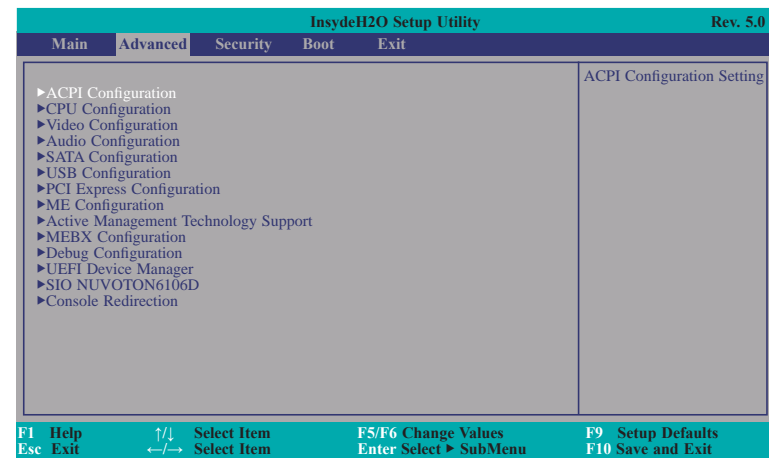

ACPI Configuration

This section is used to configure the system ACPI parameters.

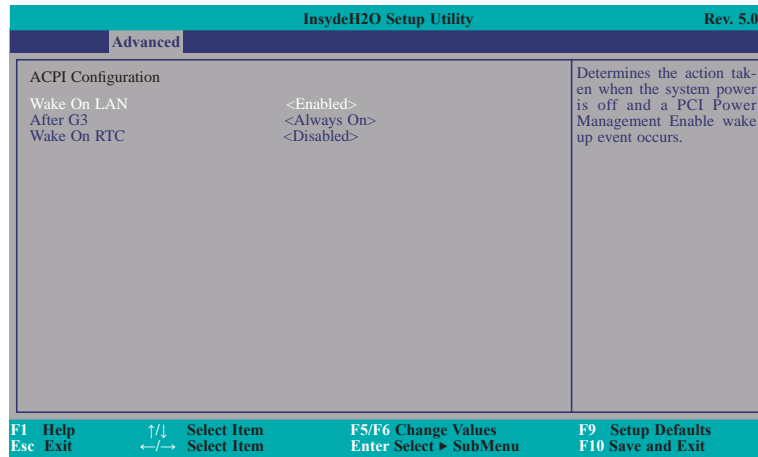

Wake On LAN

This field is used to enable or disable the LAN signal to wake up the system.

After G3

This field is to specify what state to go when power is re-applied after a power failure (G3 state).

Always On The system working state.

Always Off Off, except for trickle current to devices such as the power button.

Wake On RTC

Automatically power the system on at a particular time every day from the Real-time clock battery.

Wake up time

When Wake On RTC is set to enabled, specify the wake up time of the day: <hour> (00~23), <minute> (00~59), <second> (00~59).



Note:

Under Dual Boot Type or UEFI Boot Type mode, if Quiet Boot is set to enabled, BGRT Logo field will appear for configuration. Refer to the Boot menu (page 43) for more information.

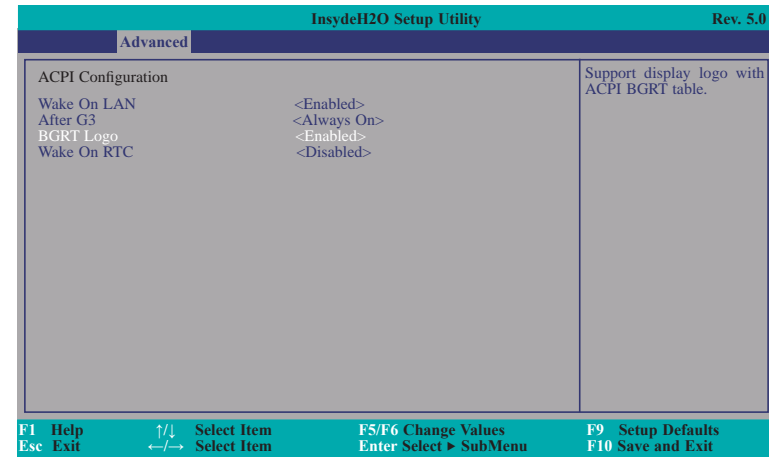

BGRT Logo

This field is used to enable or disable to support display logo with ACPI BGRT table.

CPU Configuration

This section is used to configure the CPU.

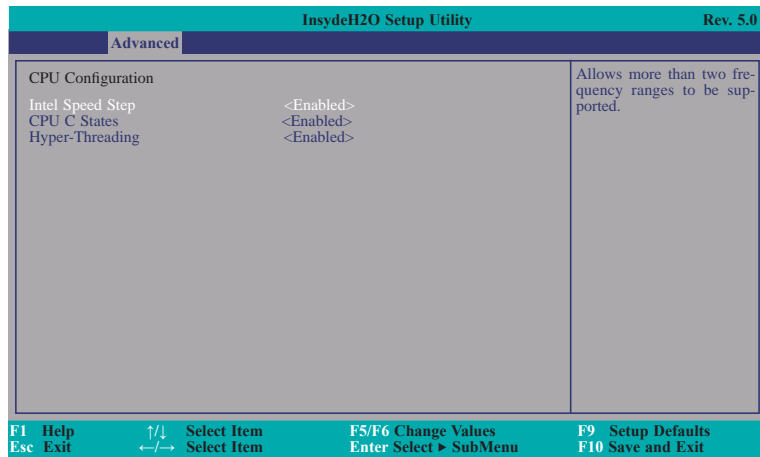

Intel Speed Step

This field is used to enable or disable the Intel Enhanced SpeedStep Technology.

CPU C States

Enable or disable the CPU Power Management.

Hyper-Threading

Enables this field for Windows XP and Linux which are optimized for Hyper-Threading technology. Select disabled for other OSes not optimized for Hyper-Threading technology. When disabled, only one thread per enabled core is enabled.

Video Configuration

This section configures the video settings.

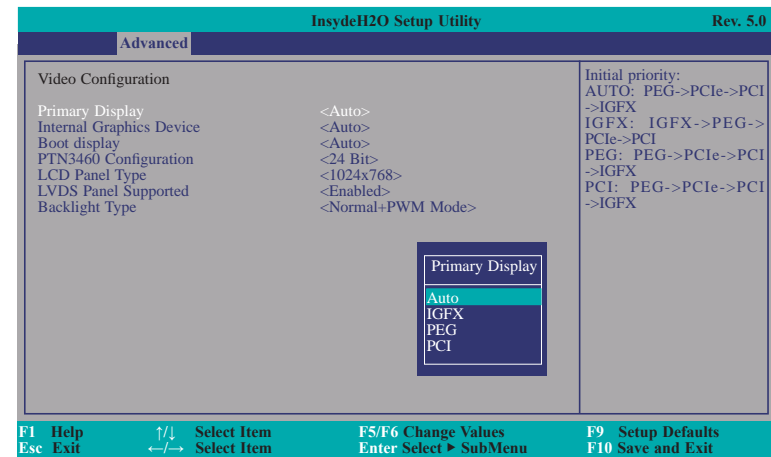

Primary Display

Set the initial priority.

Internal Graphics Device

Keep IGFX enabled or disabled based on the setup options.

Boot display

Set the display device combination.



Note:

To control "Primary Display" & "Boot display", first go to "Boot" menu and select different "Boot Type" (page 43).

Boot Type : Legacy Boot Type -> Hide Primary Display & Show Boot Display

Boot Type : UEFI Boot Type -> Show Primary Display & Hide Boot Display

Boot Type : Dual Boot Type -> Show Primary Display & Show Boot Display

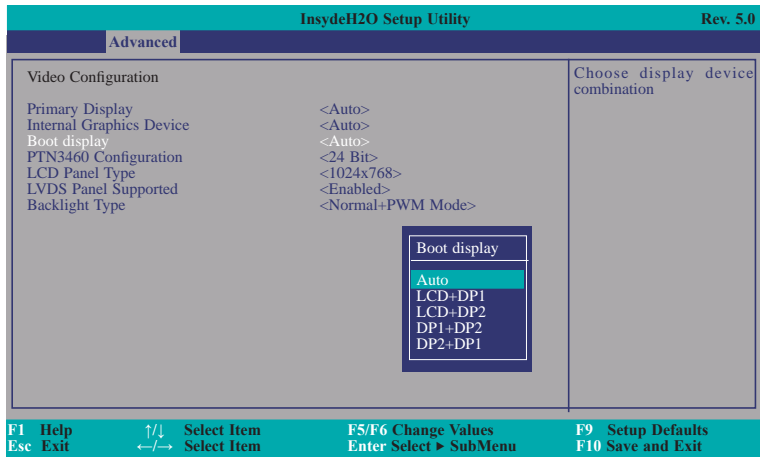

PTN3460 Configuration

Set the PTN3460 color depth: 18 bit, 24 bit, 36 bit or 48 bit.

LCD Panel Type

Please check the specifications of your LCD monitor. Select the type of LCD panel connected to the system's LCD connector: VBIOS Default, 800x480, 800x600, 1024x768, 1366x768, 1280x1024, 1920x1080 or 1920x1200.

LVDS Panel Supported

Enable or disable PTN3460 function for LVDS panel.

Backlight Type

Set the backlight type: Normal+PWM Mode, Normal+DC Mode, Invert+PWM Mode or Invert+DC Mode.

Audio Configuration

This section is used to configure the audio settings.

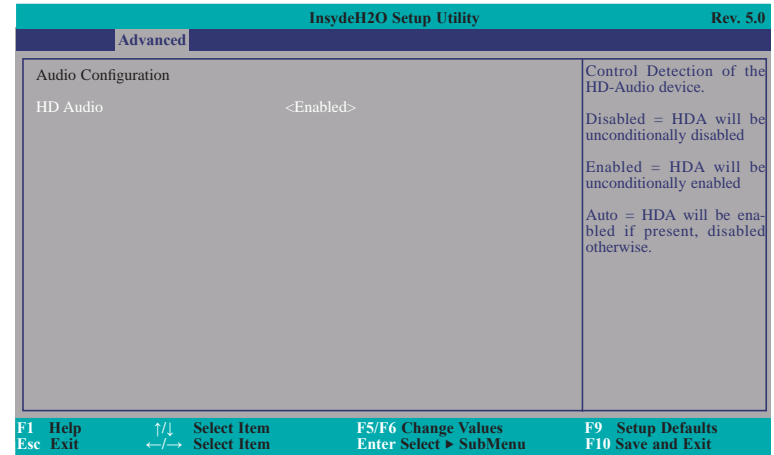

HD Audio

Control the detection of the HD-Audio device.

Disabled

HDA will be unconditionally disabled.

Enabled

HDA will be unconditionally enabled.

Auto

HDA will be enabled if present, disabled otherwise.

SATA Configuration

This section is designed to select the SATA controller and the type of hard disk drive which are installed in your system unit.

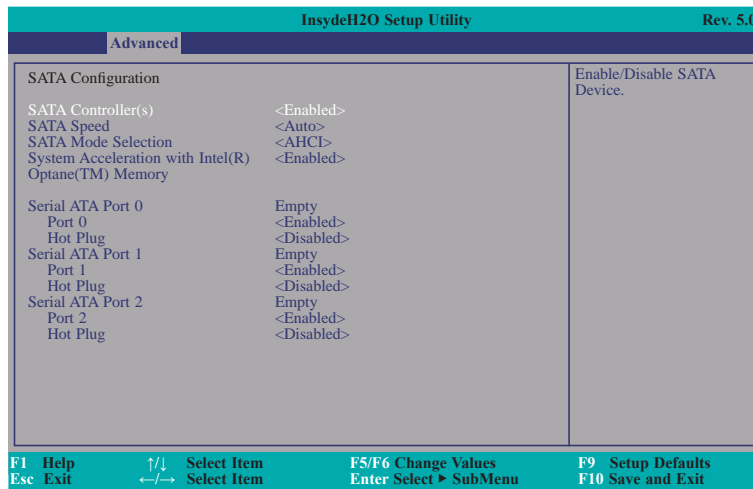

Serial ATA Port 0, 1, 2 and Hot Plug

These fields are used to enable or disable the serial ATA ports and their hot plugs. Serial ATA Port 2 is used to configure SATA signal of M.2.

SATA Controller(s)

This field is used to enable or disable Serial ATA devices.

SATA Speed

This field is used to select SATA speed generation limit: Auto, Gen1, Gen2 or Gen3.

SATA Mode Selection

The mode selection determines how the SATA controller(s) operates.

AHCI

This option allows the Serial ATA devices to use AHCI (Advanced Host Controller Interface).

Intel RST Premium With Intel Optane System Acceleration

This option allows you to create RAID or Intel Rapid Storage Technology configuration with Intel® Optane™ system acceleration on Serial ATA devices.

System Acceleration with Intel(R) Optane(TM) Memory

This field is used to enable or disable the system acceleration with Intel® Optane™ memory feature.

USB Configuration

This section is used to configure the parameters of the USB device.

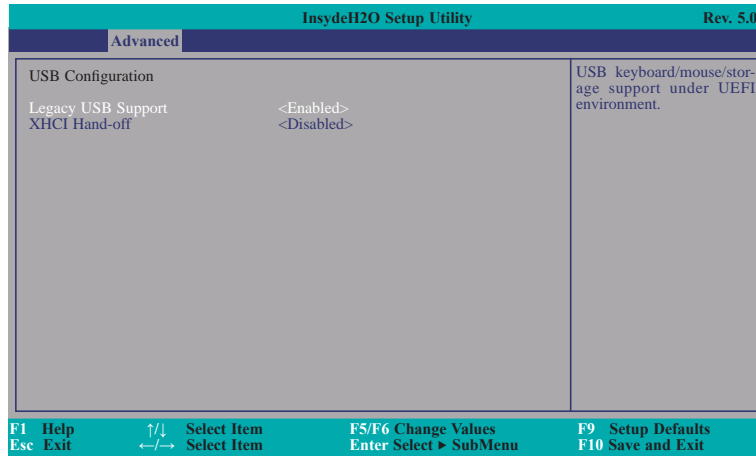

Legacy USB Support

Disabled

Disable USB keyboard/mouse/storage support under UEFI environment.

Enabled

Enable USB keyboard/mouse/storage support under UEFI environment.

XHCI Hand-off

Enable or disable to clear XHCI controller ownership change SMI bit by BIOS.

PCI Express Configuration

This section configures settings relevant to PCI Express root ports.

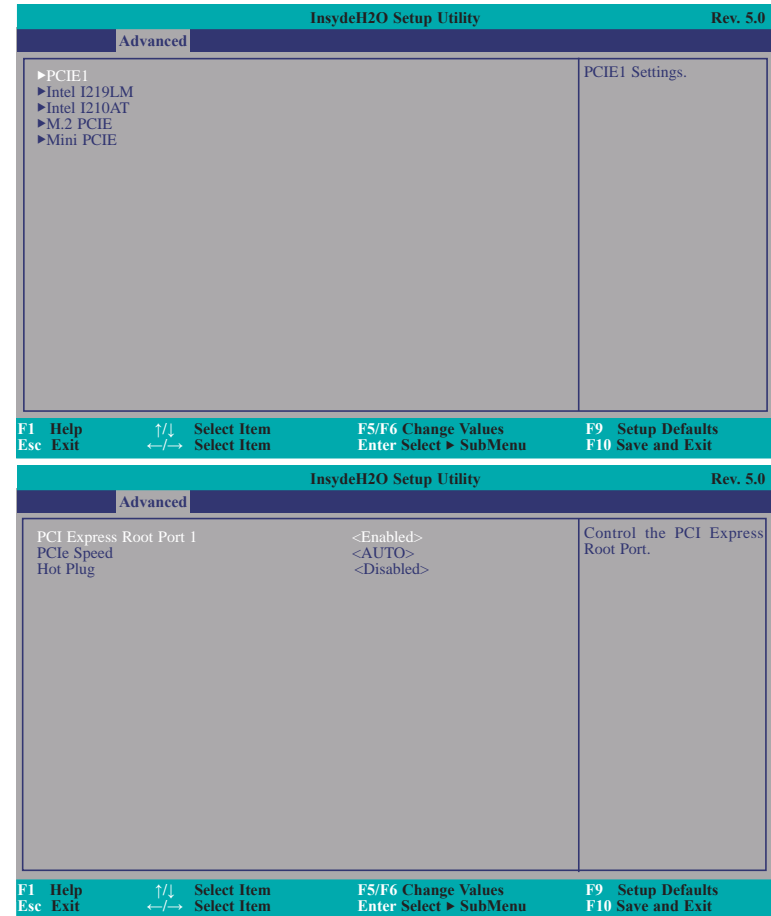

PCI Express Root Port 1/5/6/9/12

This field is used to enable or disable the PCI Express Root Port.

PCI Express Speed

Select the speed of the PCI Express Root Port: AUTO, Gen1, Gen2 or Gen3.

Hot Plug

This field is used to enable or disable the PCI Express Hot Plug.

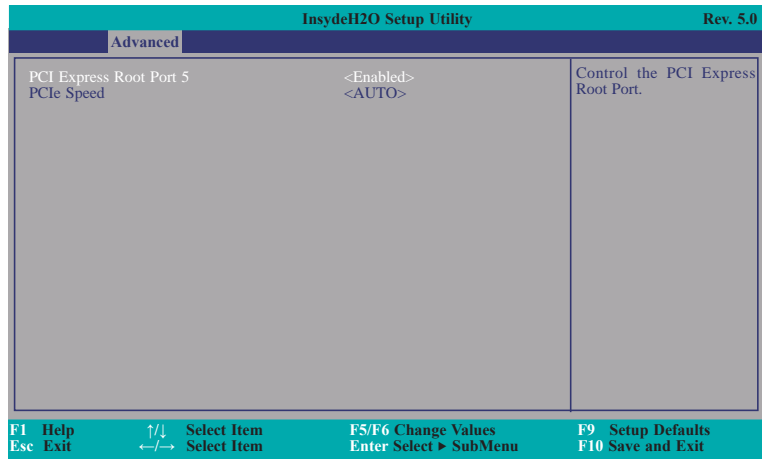

ME Configuration

This section configures settings relevant to flash ME region.

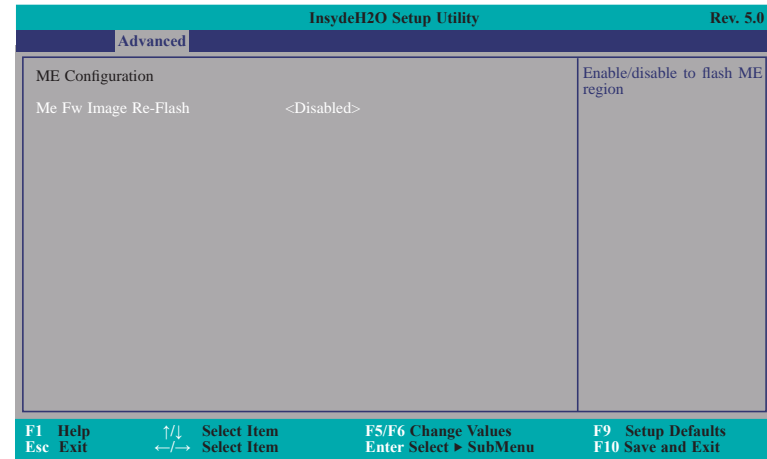

Me Fw Image Re-Flash

This field is used to enable or disable the flash ME region.

Active Management Technology Support

The section allows users to enable or disable the Intel® Active Management Technology (Intel® AMT). Please refer to **Chapter 6** for more information.

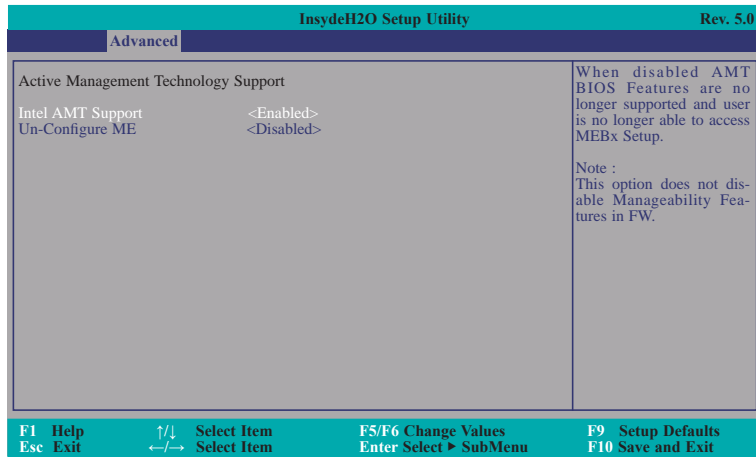

Intel AMT Support

This field is used to enable or disable Intel® Active Management Technology BIOS.

Un-Configure ME

This field is used to enable or disable to un-configure ME with resetting MEBX password to default.

MEBX Configuration

Configure Intel® Active Management Technology (Intel® AMT) in the Intel® Management Engine BIOS Extension (MEBX) section. Please refer to **Chapter 6** for more information.

Debug Configuration

This section configures Debug setting.

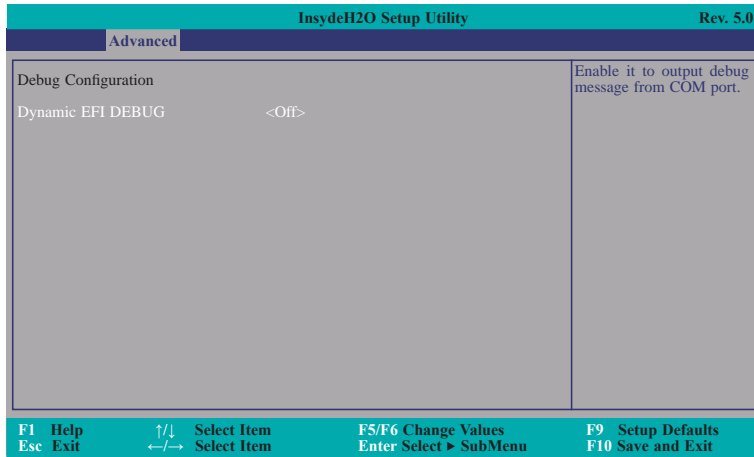

Dynamic EFI DEBUG

This field is used to turn on or off the function to output debug message from COM port. If set to on, relevant EFI debug information will show up.

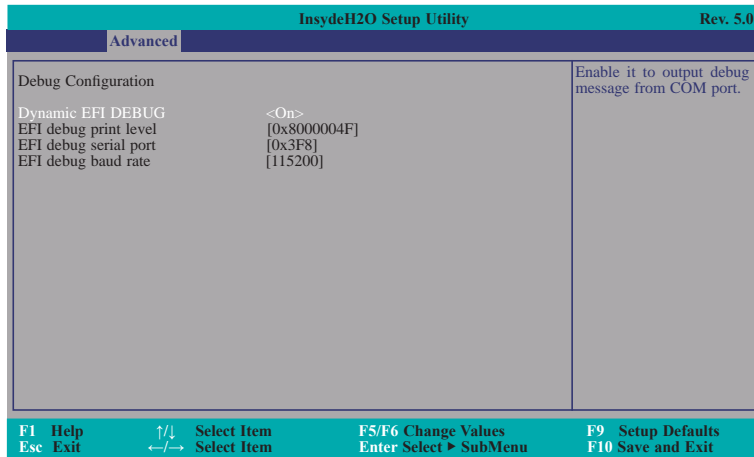

UEFI Device Manager

The section configures UEFI device with option ROM, such as LAN card, etc.

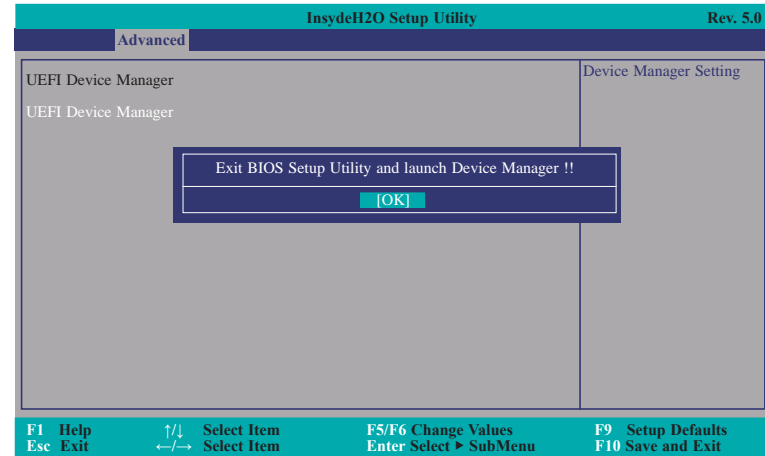

SIO NUVOTON6106D

This section configures the system super I/O chip parameters.

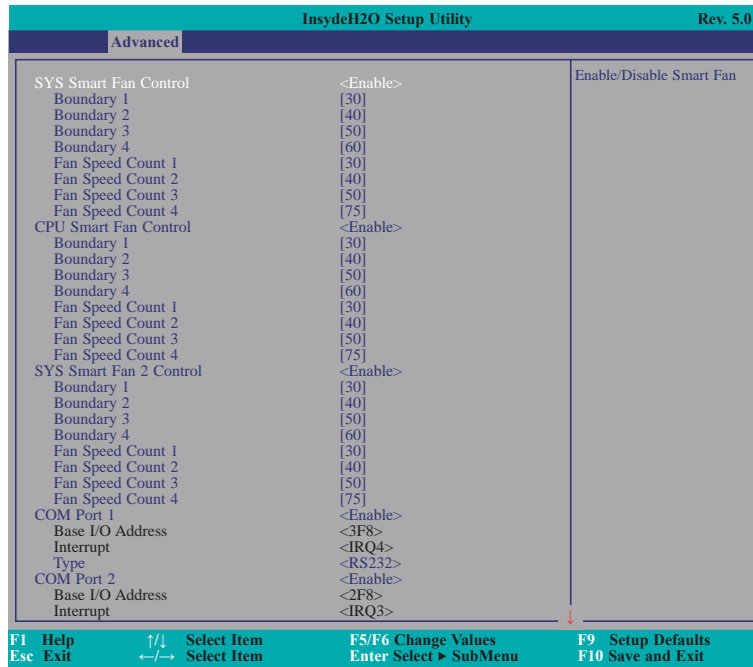
**Note:**

SYS Smart Fan Control, CPU Smart Fan Control, and SYS Smart Fan 2 Control can be switched to <Disable>. When they are disabled, it will enable "Fix Fan Speed Count".

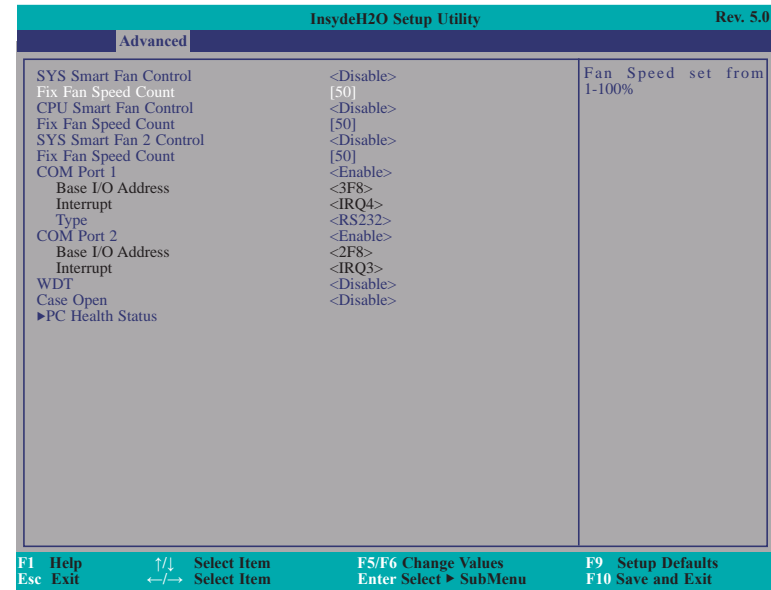
**SYS Smart Fan, CPU Smart Fan, SYS Smart Fan 2 Control**

Enable or disable the system/CPU smart fan/fan 2.

Boundary 1 to Boundary 4

Set the boundary temperatures that determine the operation of the fan with different fan speeds accordingly. For example, when the system or the CPU temperature reaches boundary temperature 1, the system or CPU fan should be turned on and operate at the designated speed. The range is from 0-127°C.

Fan Speed Count 1 to Fan Speed Count 4

Set the fan speed. The range is from 1-100% (full speed).

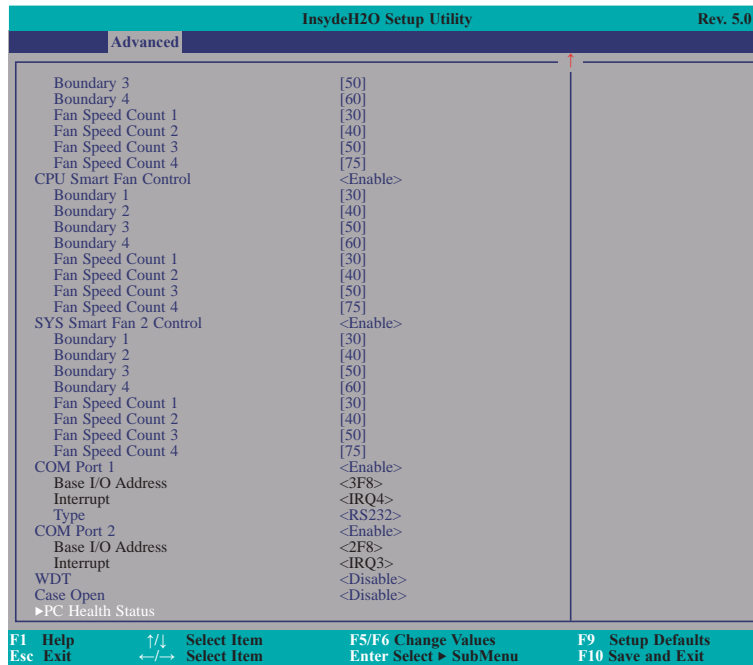

COM Port 1/2

Configure the settings to use the serial port.

Disable No configuration

Enable User configuration

Type

Choose RS232, RS422 or RS485 (Peer-to-Peer) for the serial port type for COM port 1.

WDT

Enable or disable the watchdog function. A counter will appear if you select to enable

WDT. Input any value between 1 to 255 seconds.

Case Open

Enable or disable the case open detection function.

PC Health Status

This section displays the PC health status.

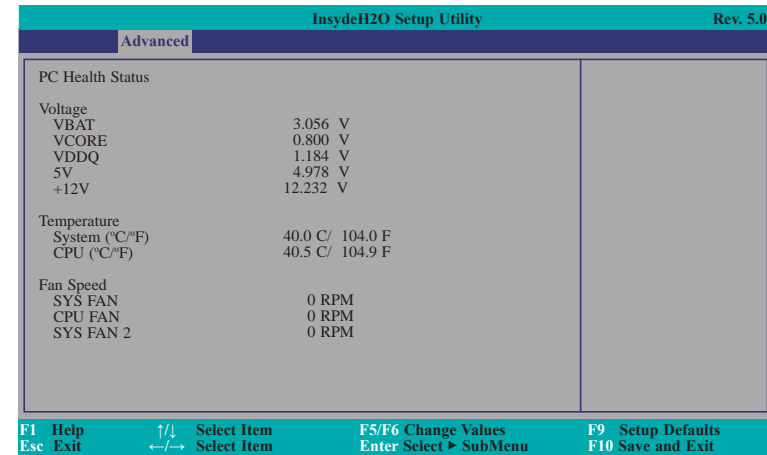

Console Redirection

This section configures settings relevant to console redirection.

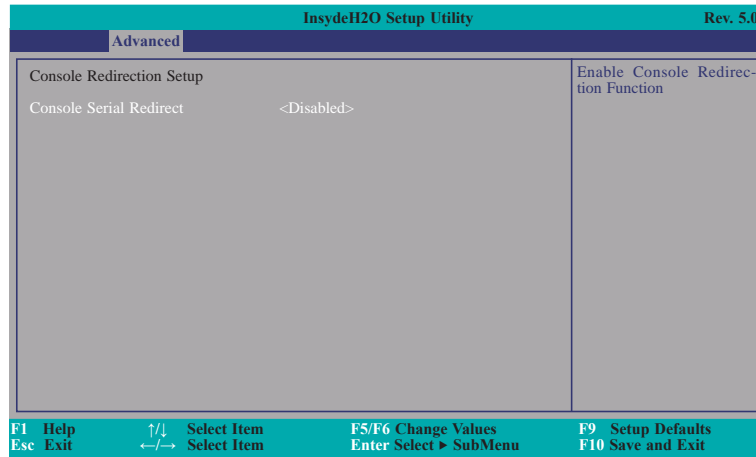

Console Serial Redirect

This field is used to enable or disable the console serial redirection function.

When Console Serial Redirect is set to enabled, the screen will appear like below:

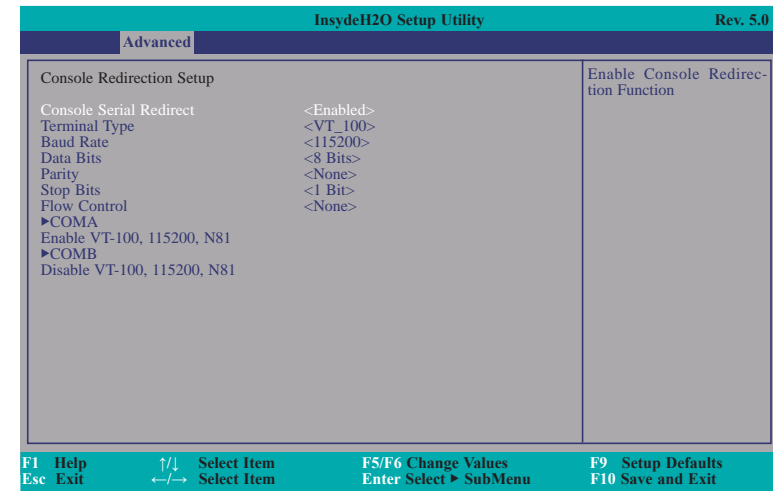

Terminal Type

Select terminal type: VT_100, VT_100+, VT_UTF8 or PC_ANSI.

Baud Rate

Select baud rate: 115200, 57600, 38400, 19200, 9600, 4800, 2400 or 1200.

Data Bits

Select data bits: 7 bits or 8 bits.

Parity

Select parity bits: none, even or odd.

Stop Bits

Select stop bits: 1 bit or 2 bits.

Flow Control

Select flow control type: none, RTS/CTS or XON/XOFF.

COMA/COMB

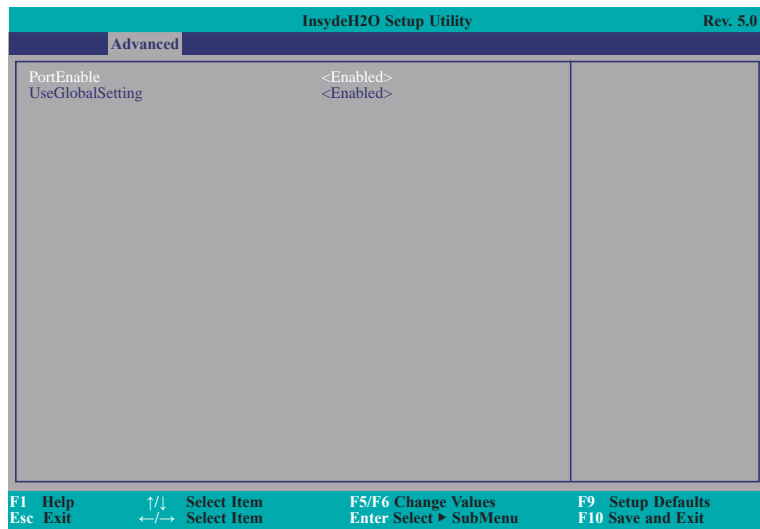
**PortEnable**

This field is used to enable or disable the COM port to redirect the console.

UseGlobalSetting

This field is to enable or disable to use global setting. When enabled the global setting, setting of the COM port will be the same as those in Console Redirection section. When disabled the global setting, setting of the COM port can be configured independently in this section.

When UseGlobalSetting is set to disabled, the screen will appear like below:

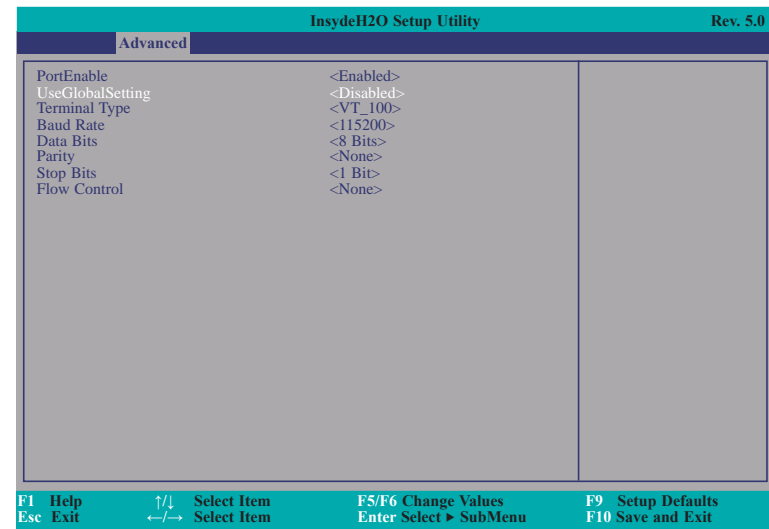

Security

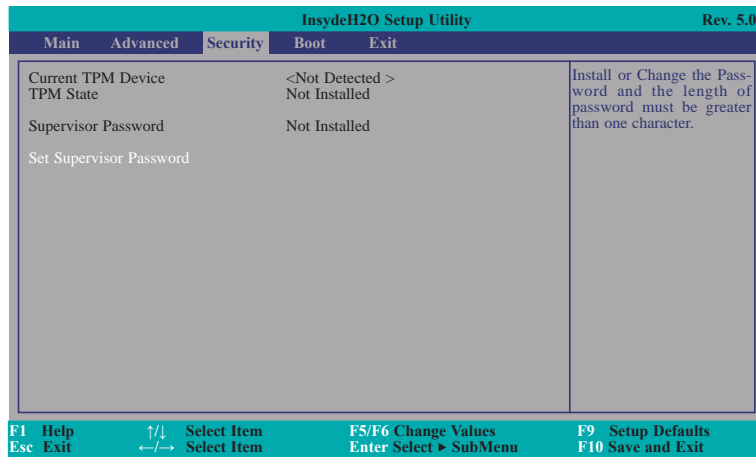

Set Supervisor Password

Set the supervisor's password and the length of the password must be greater than one character.

Boot

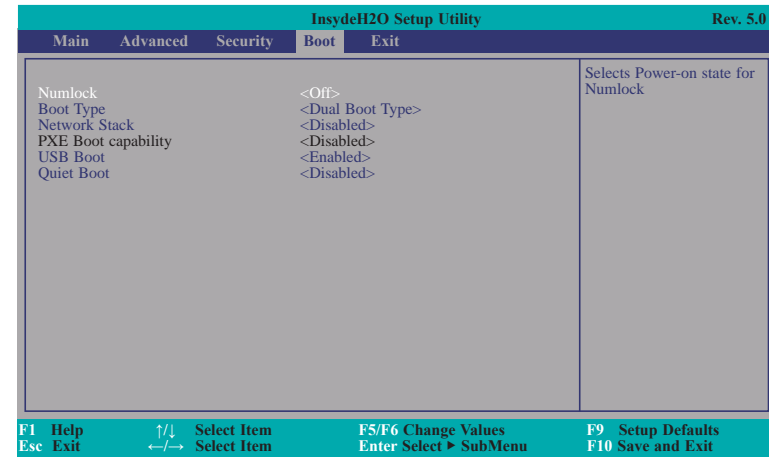

Numlock

Select the power-on state for numlock.

Boot Type

Select the boot type. The options are UEFI Boot Type, Legacy Boot Type or Dual Boot Type.

If you select "UEFI Boot Type" or "Dual Boot Type", the "Network Stack", "PXE Boot capability", "USB Boot" and "Quiet Boot" will show up.

If you select "Legacy Boot Type", "PXE Boot to LAN", "USB Boot" and "Quiet Boot" will show up.



Note:

If the boot type is set to UEFI, the method for RAID volume creation will be different. Please refer to Chapter 5 - RAID for more information.

Network Stack

This field is used to enable or disable network stack.

PXE Boot capability

Disabled Support Network Stack

UEFI IPv4/IPv6

Legacy Legacy PXE OPROM only

PXE Boot to LAN

Disable or enable PXE boot to LAN.

USB Boot

Enable or disable to change USB boot devices boot order.

Quiet Boot

Enable or disable booting in text mode.

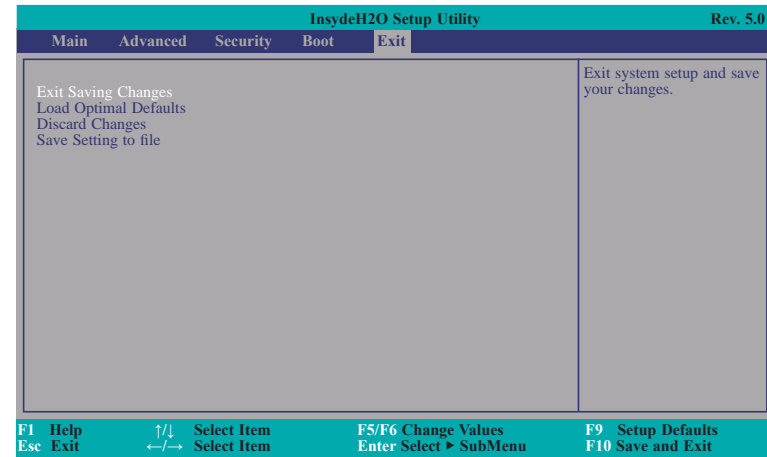
Exit**Exit Saving Changes**

Select Yes and then press <Enter> to exit the system setup and save your changes.

Load Optimal Defaults

Select YES and then press <Enter> to load optimal defaults.

Discard Changes

Select YES and then press <Enter> to exit the system setup without saving your changes.

Save Setting to file

Select this option to save BIOS configuration settings to a USB flash device.

Restore Setting from file

This field will appear only when a USB flash device is detected. Select this field to restore setting from the USB flash device.

Updating the BIOS

To update the BIOS, you will need the new BIOS file and a flash utility. Please contact technical support or your sales representative for the files.

Notice: BIOS SPI ROM

1. The Intel® Management Engine has already been integrated into this system board. Due to the safety concerns, the BIOS (SPI ROM) chip cannot be removed from this system board and used on another system board of the same model.
2. The BIOS (SPI ROM) on this system board must be the original equipment from the factory and cannot be used to replace one which has been utilized on other system boards.
3. If you do not follow the methods above, the Intel® Management Engine will not be updated and will cease to be effective.

**Note:**

- a. You can take advantage of flash tools to update the default configuration of the BIOS (SPI ROM) to the latest version anytime.
- b. When the BIOS IC needs to be replaced, you have to populate it properly onto the system board after the EEPROM programmer has been burned and follow the technical person's instructions to confirm that the MAC address should be burned or not.

Chapter 4 - Supported Software

Install drivers, utilities and software applications that are required to facilitate and enhance the performance of the system board. You may acquire the software from your sales representatives, from an optional DVD included in the shipment, or from the website download page at <https://www.dfi.com/DownloadCenter>.

Intel Chipset Software Installation Utility

The Intel Chipset Software Installation Utility is used for updating Windows® INF files so that the Intel chipset can be recognized and configured properly in the system.

To install the utility, download "KU171_KU173 Chipset Driver" zip file at our website.

1. Setup is ready to install the utility. Click "Next".

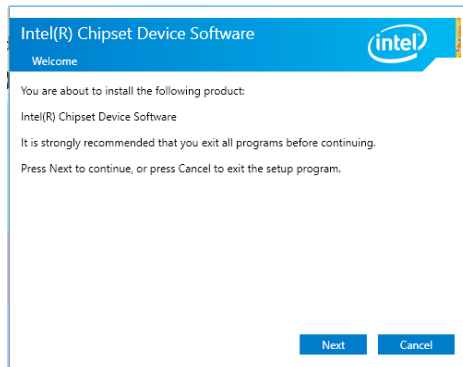

2. Read the license agreement then click "Accept".

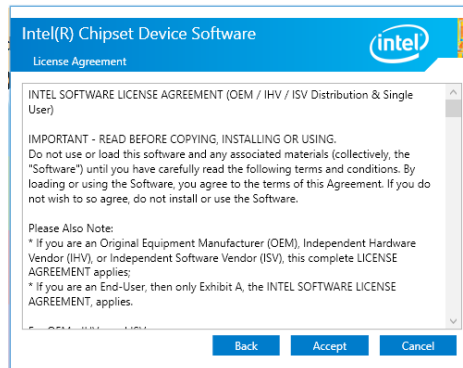

3. Go through the readme document for more installation tips then click "Install".

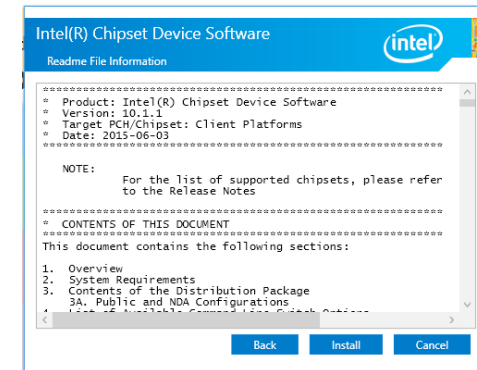

4. The step displays the installing status in the progress.

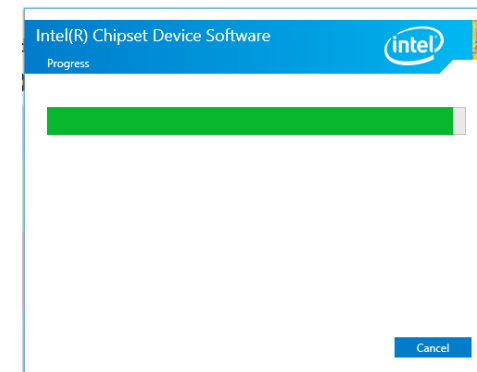

5. After completing installation, click "Restart Now" to exit setup.

Restarting the system will allow the new software installation to take effect.

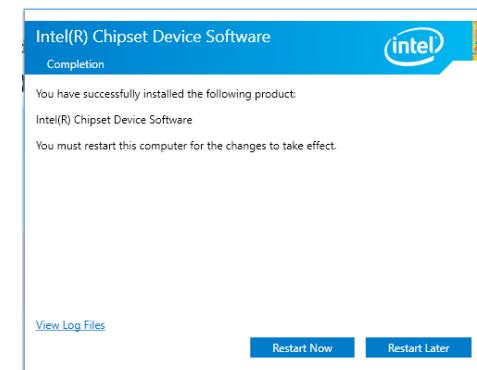

Intel Graphics Drivers

To install the driver, download “KU171_KU173 Graphics Driver” zip file at our website.

1. Setup is now ready to install the graphics driver. Click “Next”.

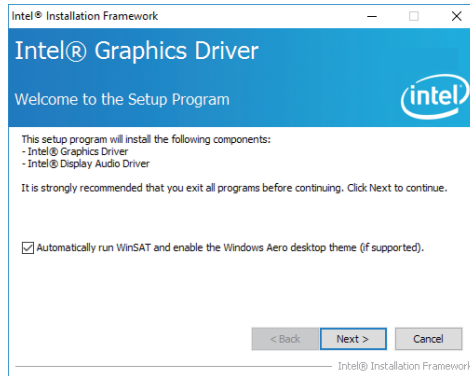

By default, the “Automatically run WinSAT and enable the Windows Aero desktop theme” is enabled. With this enabled, after installing the graphics driver and the system rebooted, the screen will turn blank for 1 to 2 minutes (while WinSAT is running) before the Windows 10 desktop appears. The “blank screen” period is the time Windows is testing the graphics performance.

We recommend that you skip this process by disabling this function then click “Next”.

2. Read the license agreement then click “Yes”.

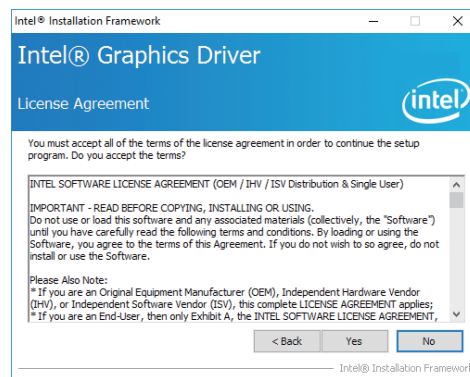

3. Go through the readme document for system requirements and installation tips then click “Next”.

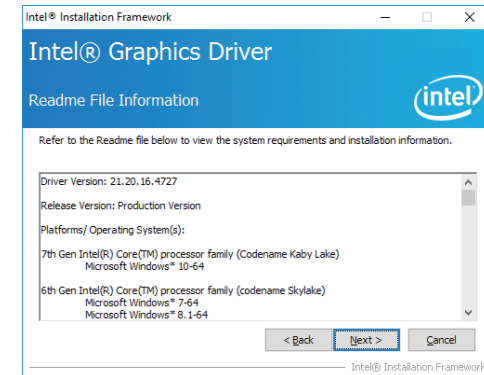

4. Setup is now installing the driver. Click “Next” to continue.

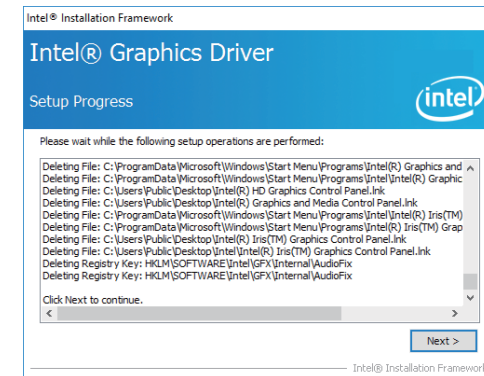

5. Click “Yes, I want to restart this computer now” then click “Finish”.

Restarting the system will allow the new software installation to take effect.

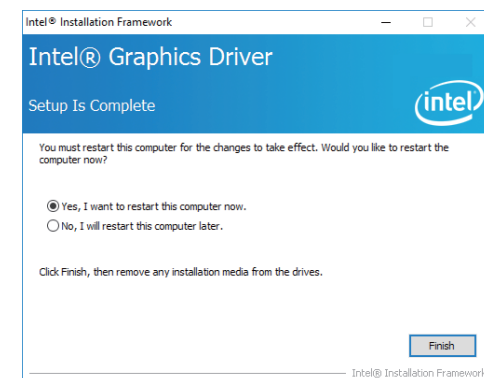

Audio Driver

To install the driver, download “KU171_KU173 Audio Driver” zip file at our website.

1. Setup is ready to install the driver. Click “Next”.

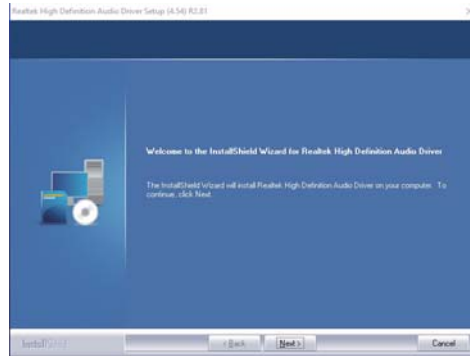

2. Click “Yes, I want to restart my computer now” then click “Finish”.

Restarting the system will allow the new software installation to take effect.

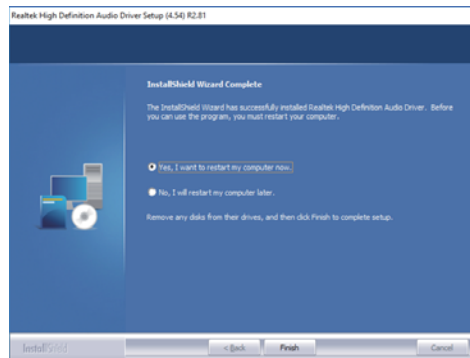

Intel LAN Driver

To install the driver, download “KU171_KU173 LAN Driver” zip file at our website.

1. Setup is ready to install the driver. Click “Next”.

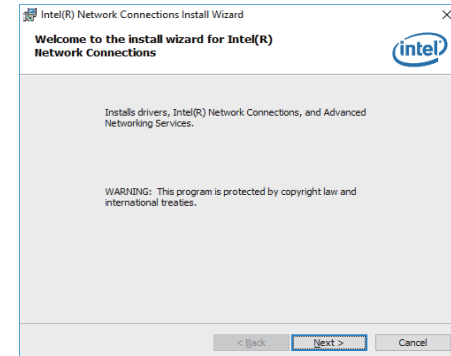

2. Click “I accept the terms in the license agreement” then click “Next”.

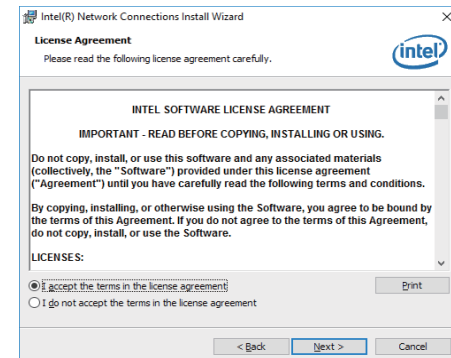

3. Select the program features you want installed then click “Next”.

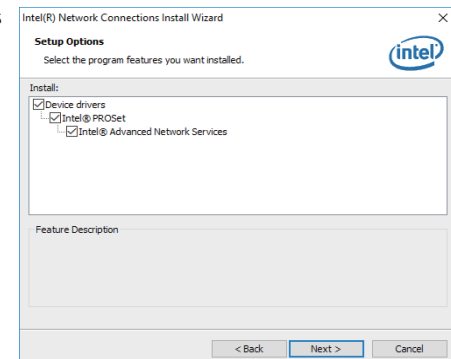

- Click "Install" to begin the installation.

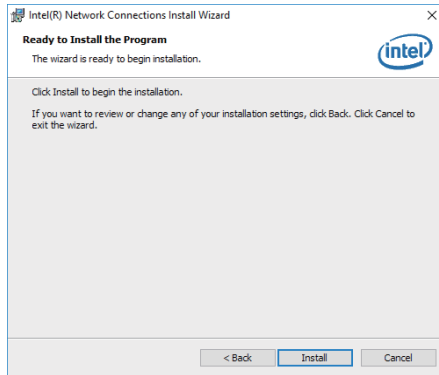

- The step displays the installing status in the progress.

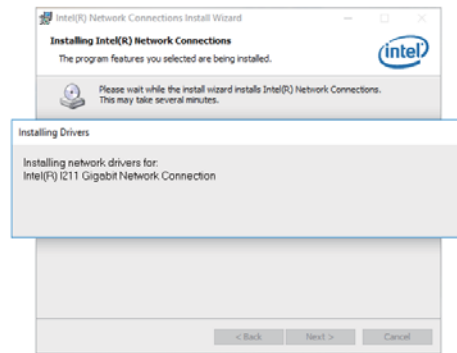

- After completing installation, click "Finish".

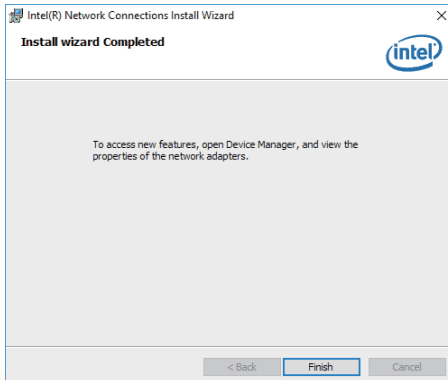

Intel Management Engine Drivers

To install the driver, download "KU171_KU173 MEI Driver" zip file at our website.

- Setup is ready to install the driver. Click "Next".

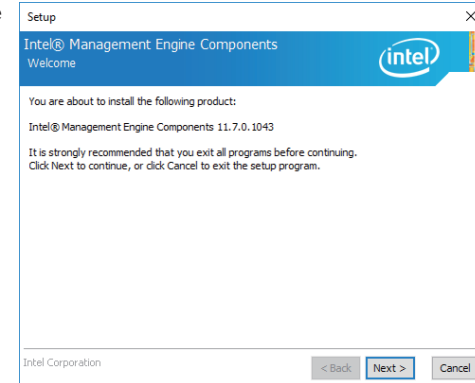

- Read the license agreement then tick "I accept the terms in the License Agreement". Click "Next".

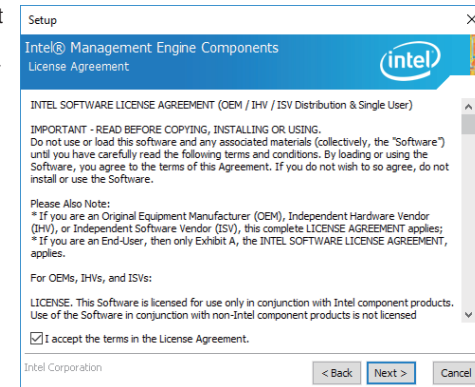

- Click "Next" to install to the default folder, or click "Change" to choose another destination folder.

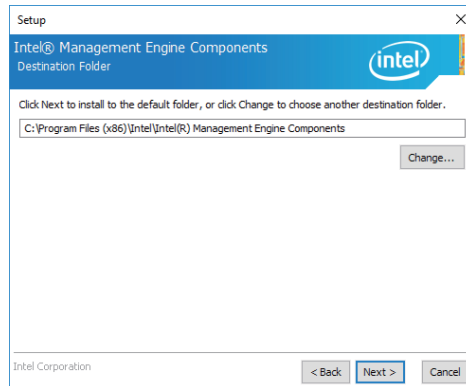

- Please wait while the product is being installed.

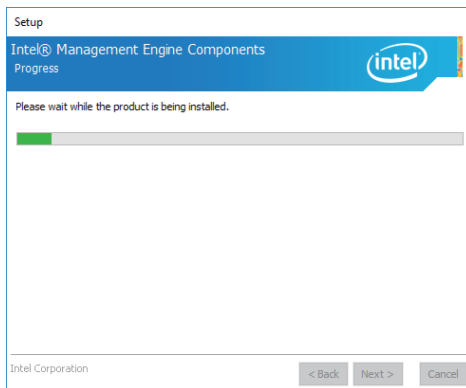

- After completing installation, click "Finish".

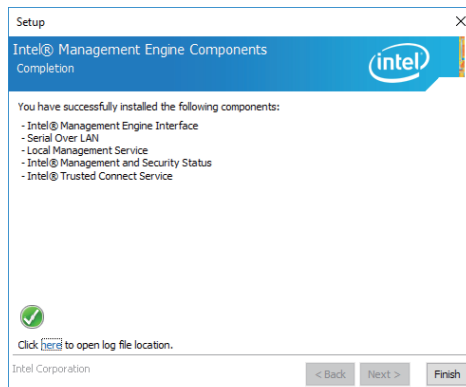

SIO Driver

To install the driver, download "KU171_KU173 SIO Driver" zip file at our website.

- Setup is ready to install the driver. Click "Next".

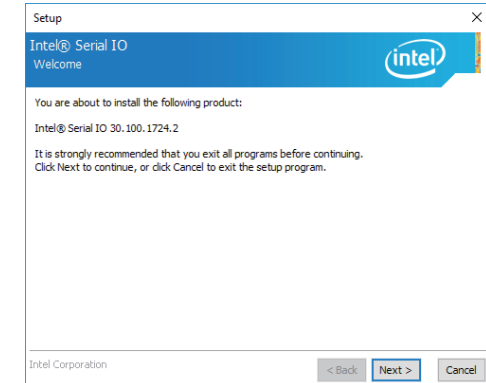

- Read the license agreement carefully. Tick "I accept the terms in the License Agreement" then click "Next".



3. Go through the readme document for system requirements and installation tips then click "Next".

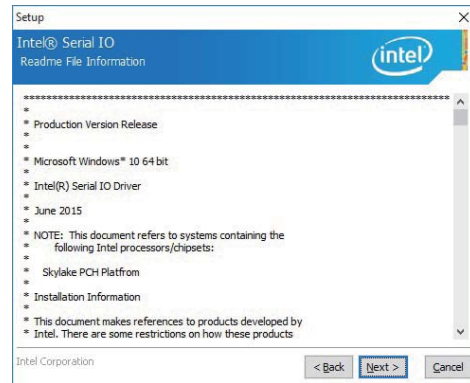

4. Setup is ready to install the driver. Click "Next".

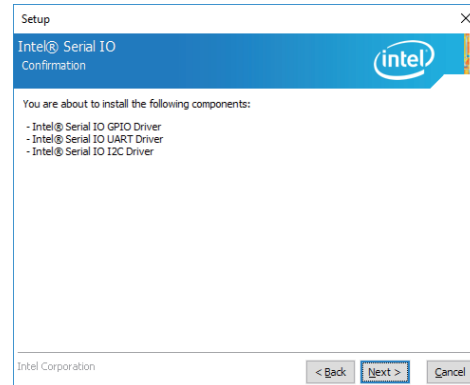

5. Setup is now installing the driver.

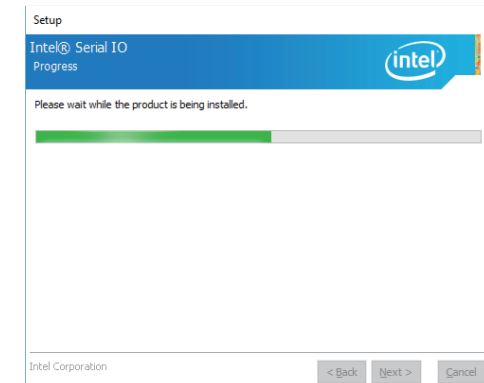

6. Click "Yes, I want to restart this computer now" then click "Finish".

Restarting the system will allow the new software installation to take effect.

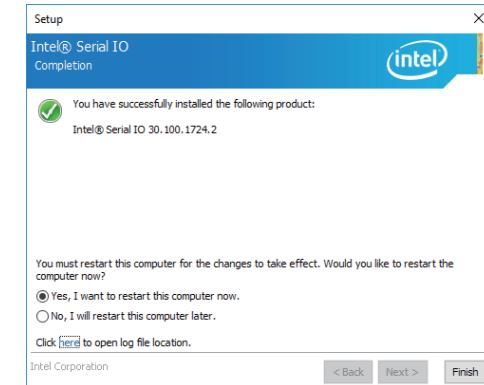

Adobe Acrobat Reader 9.3

To install the reader, download “KU171_KU173 Driver Package” iso file at our website.

1. Click “Next” to install or click “Change Destination Folder” to select another folder.

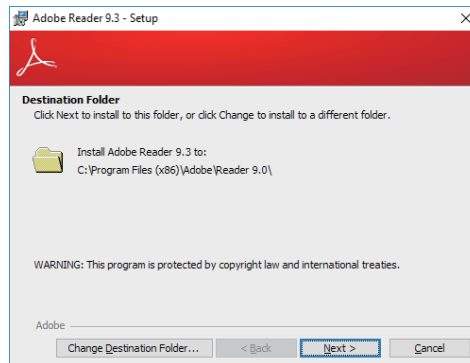

2. Click “Install” to begin installation.

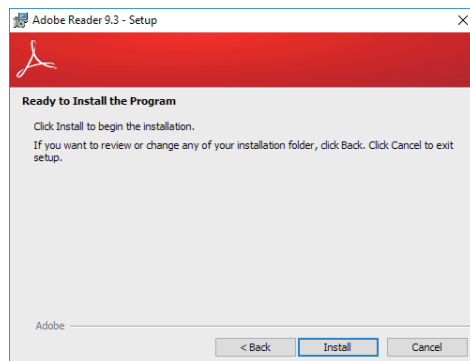

3. Setup is now installing the driver.

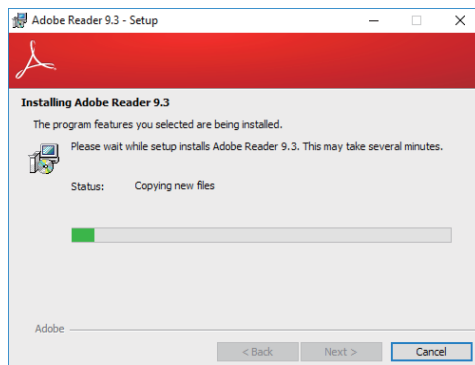

4. Click “Finish” to exit installation.

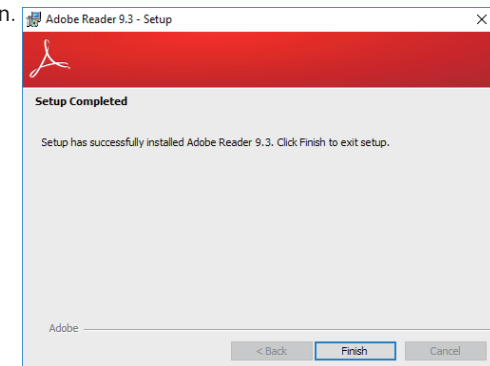

Intel Rapid Storage Technology

The Intel Rapid Storage Technology is a utility that allows you to monitor the current status of the SATA drives. It enables enhanced performance and power management for the storage subsystem.

To install the driver, download “KU171_KU173 Intel Rapid Storage Driver” zip file at our website. Please refer to **Chapter 5** for more information.

Chapter 5 - RAID

The system board allows configuring RAID on Serial ATA drives. It supports RAID 0, RAID 1, and RAID 5.

RAID Levels

RAID 0 (Striped Disk Array without Fault Tolerance)

RAID 0 uses two new identical hard disk drives to read and write data in parallel, interleaved stacks. Data is divided into stripes and each stripe is written alternately between two disk drives. This improves the I/O performance of the drives at different channel; however it is not fault tolerant. A failed disk will result in data loss in the disk array.

RAID 1 (Mirroring Disk Array with Fault Tolerance)

RAID 1 copies and maintains an identical image of the data from one drive to the other drive. If a drive fails to function, the disk array management software directs all applications to the other drive since it contains a complete copy of the drive's data. This enhances data protection and increases fault tolerance to the entire system. Use two new drives or an existing drive and a new drive but the size of the new drive must be the same or larger than the existing drive.

RAID 5

RAID 5 stripes data and parity information across hard drives. It is fault tolerant and provides better hard drive performance and more storage capacity.

RAID Level	Min. Drives	Protection	Description
RAID 0	2	None	Data striping without redundancy
RAID 1	2	Single Drive Failure	Disk mirroring
RAID 5	3	Single Drive Failure	Block-level data striping with distributed parity

Settings

To enable the RAID function, the following settings are required.

1. Connect the Serial ATA drives.
2. Enable RAID in the Insyde BIOS.
3. Create a RAID volume.
- 3-1. Create a RAID volume if the boot type is UEFI.
4. Install the Intel Rapid Storage Technology Utility.

Step 1: Connect the Serial ATA Drives

Refer to chapter 2 for details on connecting the Serial ATA drives.



Important:

1. Make sure you have installed the Serial ATA drives and connected the data cables otherwise you won't be able to enter the RAID BIOS utility.
2. Treat the cables with extreme caution especially while creating RAID. A damaged cable will ruin the entire installation process and operating system. The system will not boot and you will lost all data in the hard drives. Please give special attention to this warning because there is no way of recovering back the data.

Step 2: Enable RAID in the Insyde BIOS

1. Power-on the system then press to enter the main menu of the Insyde BIOS.
2. Go to "Advanced" menu and select the "SATA Configuration" menu.
3. Change the "SATA Mode Selection" to "Intel RST Premium With Intel Optane System Acceleration" mode.
4. Save the changes in the "Exit" menu.
5. Reboot the system.

Step 3: Create a RAID Volume

1. When the Intel® RST option ROM status screen displays during POST, press <Ctrl> and <I> simultaneously to enter the option ROM user interface.
2. Select 1: Create RAID Volume and press <Enter>.
3. Create a volume name and press <Enter>.
4. Use the up or down arrow keys to select the RAID level and press <Enter>.
5. Use the up or down arrow keys to select the strip size and press <Enter>.
6. Select the capacity and press <Enter>. You must select less than one hundred percent of the available volume space to leave space for the second volume.
7. Press <Enter> to create the volume.
8. At the prompt, press <Y> to confirm volume creation.
9. Select 4: Exit and press <Enter>.
10. Press <Y> to confirm exit.

Step 3-1: Create a RAID Volume if the boot type is UEFI

If the boot type is set to UEFI, RAID volume creation will be different. Please use the following steps to create RAID volumes. To set the boot type, enter the Insyde BIOS and go to "Boot" > "Boot Type".

1. Go to the "Advanced" menu of the Insyde BIOS and select "UEFI Device Manager".

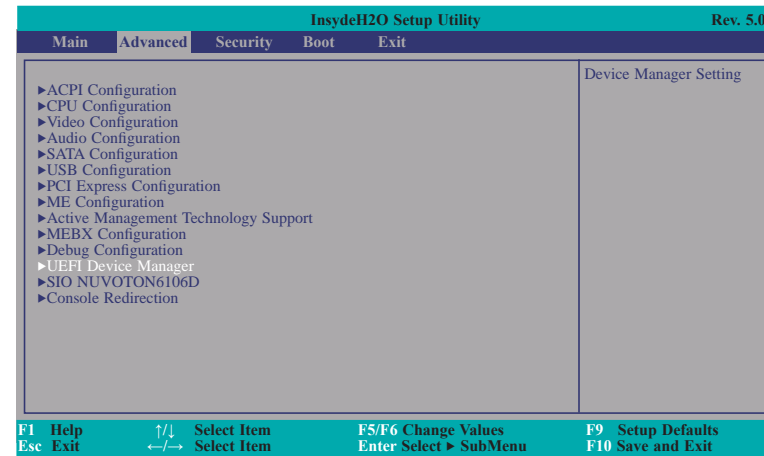

2. The screen displays all available drives. Select "Create RAID volume" to create a RAID volume".
3. Use the up or down arrow keys to select the RAID level and press <Enter>.
4. Use the up or down arrow keys to scroll through the list of hard drives and press <Enter> to select the drive.
5. Press <Enter>.
6. Use the up or down arrow keys to select the strip size and press <Enter>.
7. Enter the volume size and press <Enter>.
8. At the prompt, press <Y> to confirm volume creation.

Step 4: Install the Intel Rapid Storage Technology Utility

The Intel Rapid Storage Technology Utility can be installed from within Windows. It allows RAID volume management (create, delete, migrate) from within the operating system. It will also display useful SATA device and RAID volume information. The user interface, tray icon service and monitor service allow you to monitor the current status of the RAID volume and/or SATA drives. It enables enhanced performance and power management for the storage subsystem.

1. Download "KU171_KU173 Intel Rapid Storage Driver" zip file at our website.
2. Setup is ready to install the utility. Click "Next".

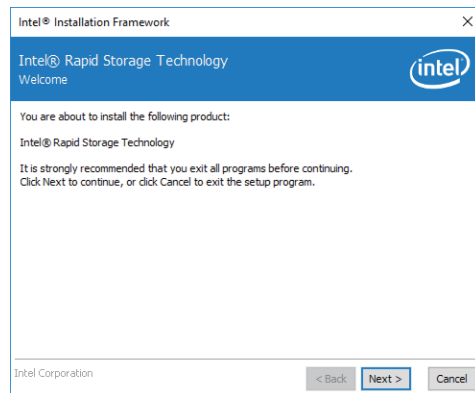

3. Read the license agreement and click "I accept the terms in the License Agreement". Then, click "Next".

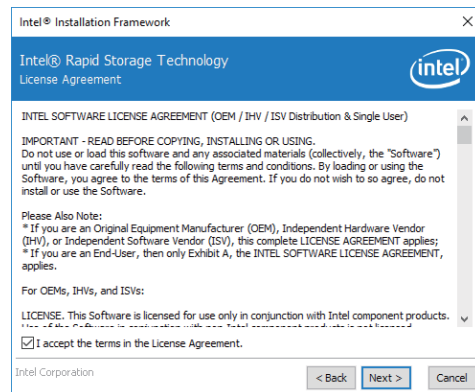

4. Go through the readme document to view system requirements and installation information then click "Next".

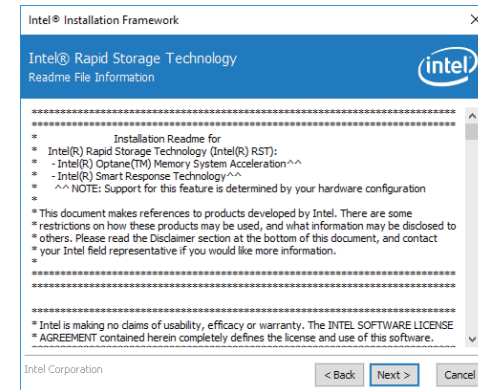

5. Click "Next" to install to the default folder or click "Change to choose another destination folder".

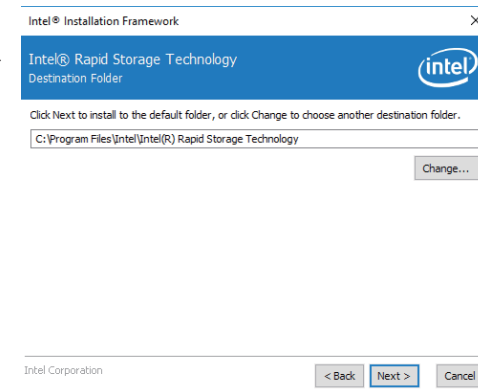

6. Confirm the installation and click "Next".

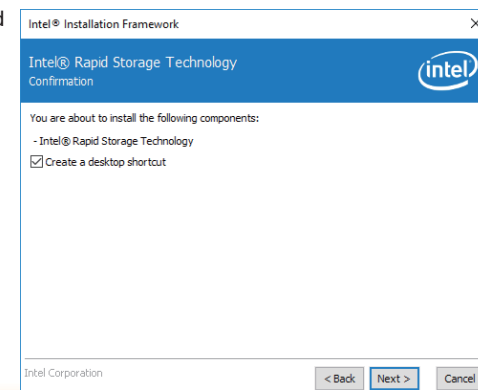

7. Click “Yes, I want to restart this computer now” to complete the installation and then click “Finish”.

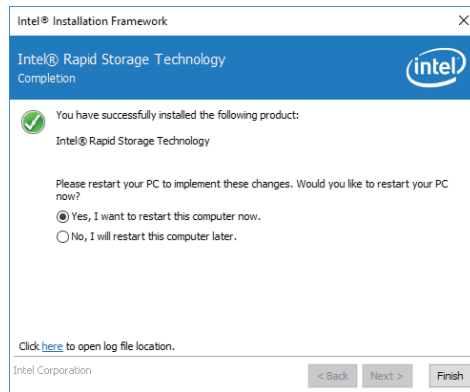

Chapter 6 - Intel AMT Settings

Overview

Intel Active Management Technology (Intel® AMT) combines hardware and software solution to provide maximum system defense and protection to networked systems.

The hardware and software information are stored in non-volatile memory. With its built-in manageability and latest security applications, Intel® AMT provides the following functions.

- **Discover**

Allows remote access and management of networked systems even while PCs are powered off; significantly reducing desk-side visits.

- **Repair**

Remotely repair systems after OS failures. Alerting and event logging help detect problems quickly to reduce downtime.

- **Protect**

Intel AMT's System Defense capability remotely updates all systems with the latest security software. It protects the network from threats at the source by proactively blocking incoming threats, reactively containing infected clients before they impact the network, and proactively alerting when critical software agents are removed.

Enable Intel® AMT in the Insyde BIOS

1. Power-on the system then press to enter the main menu of the Insyde BIOS.
2. In the **Advanced** menu, select **Active Management Technology Support**.

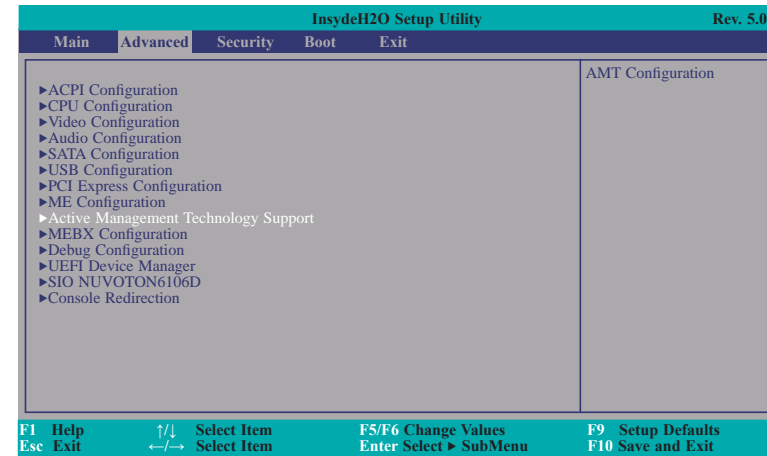

3. Select **Enabled** in the **Intel AMT Support** field.

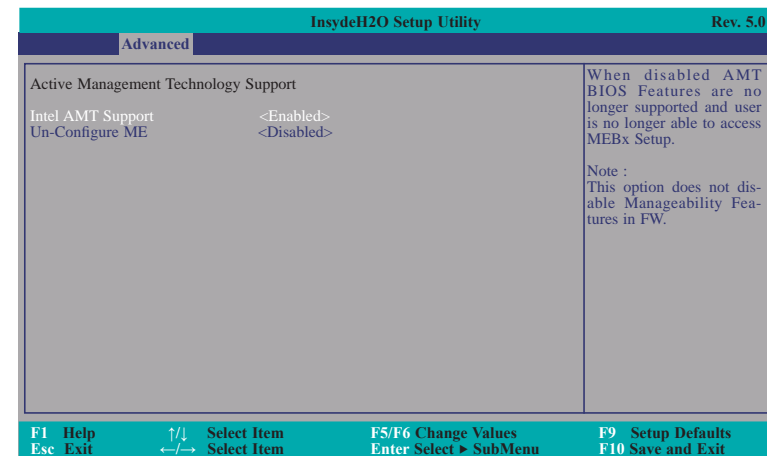

4. In the **Exit** menu, select **Exit Saving Changes** then select **Yes** and press Enter.

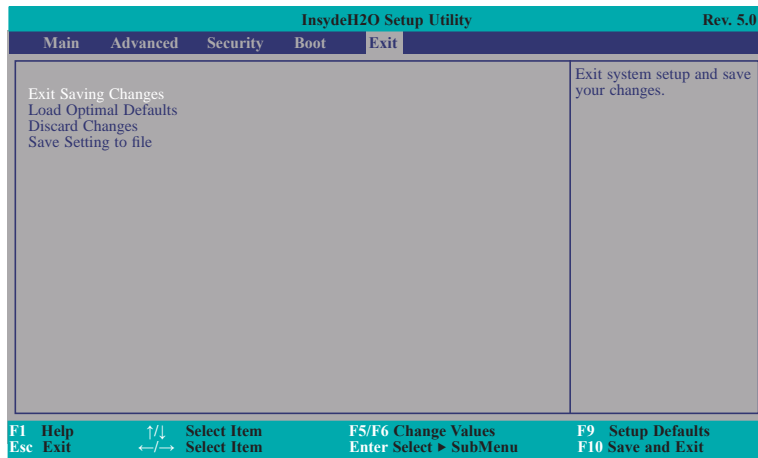

Configure Intel® AMT in the Intel® Management Engine BIOS Extension (MEBX) Section

1. After the system reboots, press to enter the main menu of the Insyde BIOS.
2. In the **Advanced** menu, select **MEBX Configuration**.

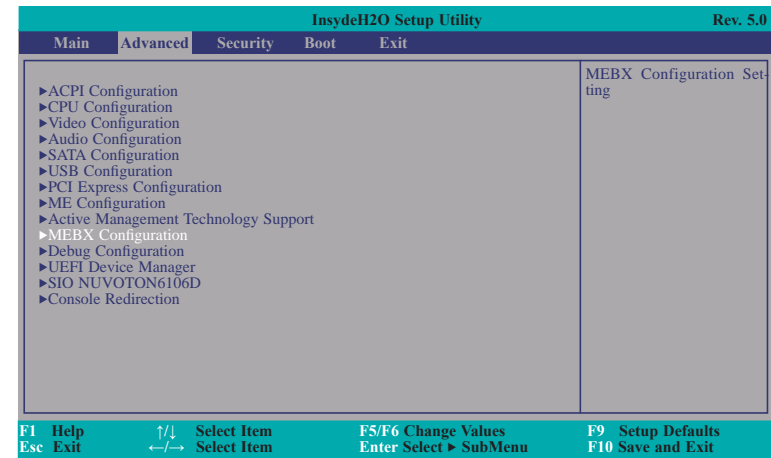

3. Select **MEBX Configuration** and press Enter.

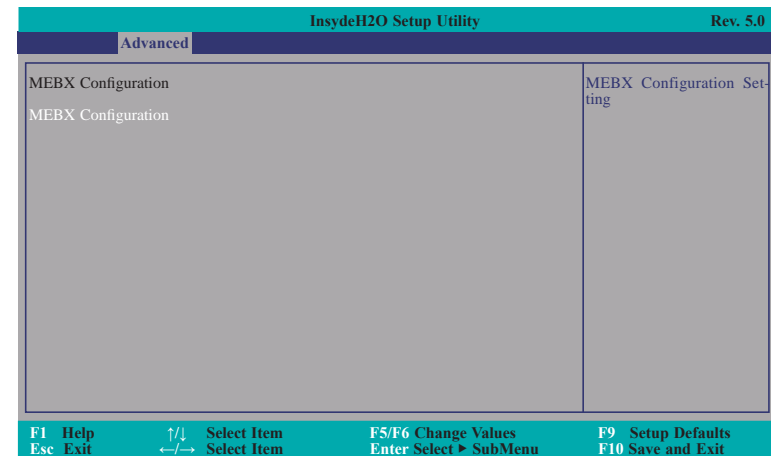

4. Select **MEBx Login** and press Enter. You will be prompted for a password. The default password is "admin". Enter the default password in the space provided under Intel(R) ME Password then press Enter.

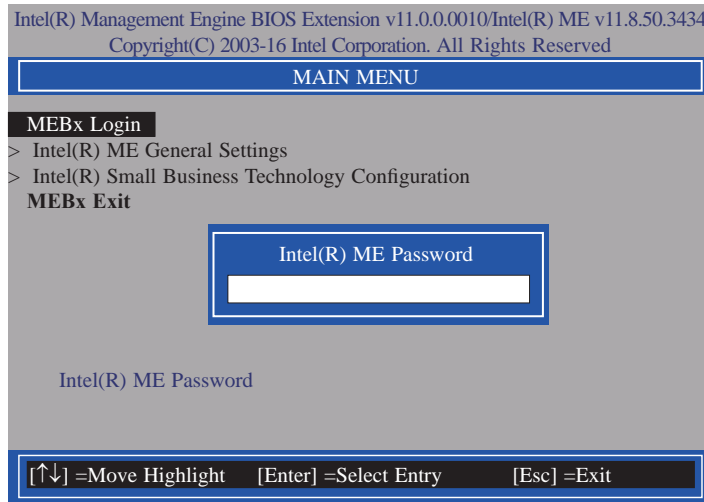

5. Enter a new password in the space provided under Intel(R) ME New Password then press Enter. The password must include:

- 8-32 characters
- Strong 7-bit ASCII characters excluding : , and " characters
- At least one digit character (0, 1, ...9)
- At least one 7-bit ASCII non alpha-numeric character, above 0x20, (e.g. !, \$, ;)
- Both lower case and upper case characters

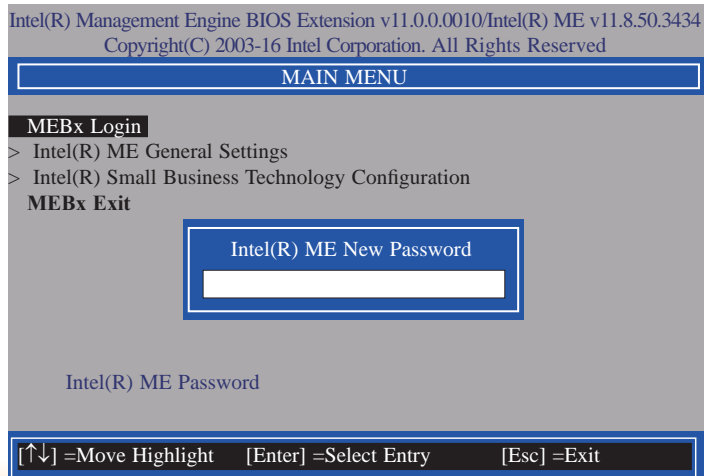

6. You will be asked to verify the new password. Enter the same new password in the space provided under Verify Password then press Enter.

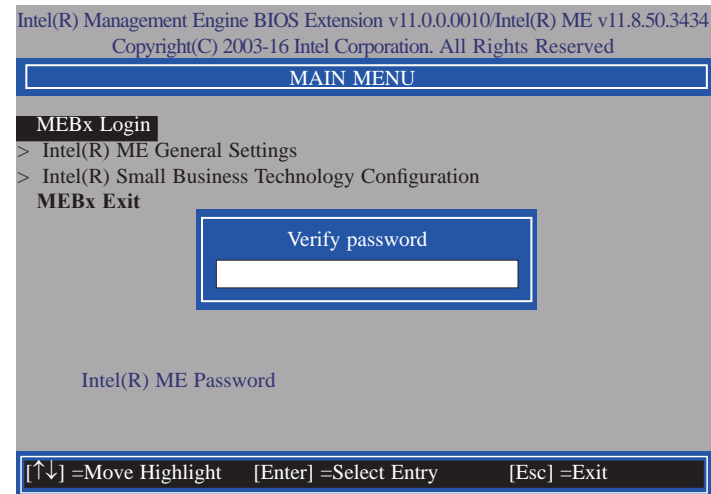

7. Select **Intel(R) ME General Settings** then press Enter.



8. If you want to change ME password, select **Change ME Password** then press Enter. Enter the current password in the space provided under Intel(R) ME Password then press Enter.

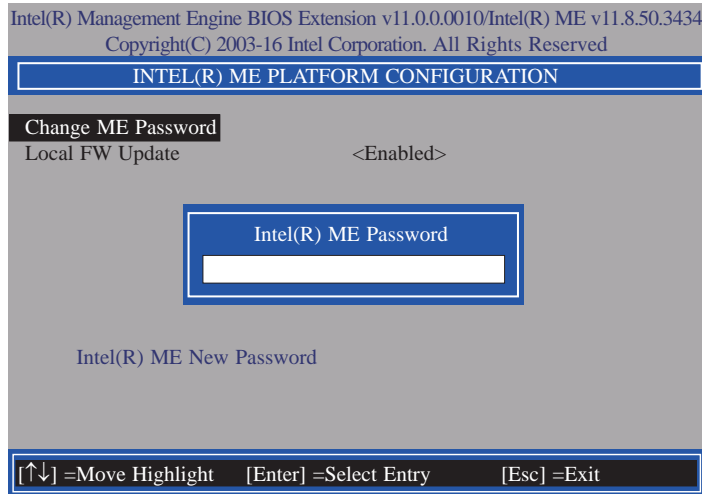

9. Enter a new password in the space provided under Intel(R) ME New Password then press Enter. The password must include:
- 8-32 characters
 - Strong 7-bit ASCII characters excluding : , and " characters
 - At least one digit character (0, 1, ...9)
 - At least one 7-bit ASCII non alpha-numeric character, above 0x20, (e.g. !, \$, ;)
 - Both lower case and upper case characters

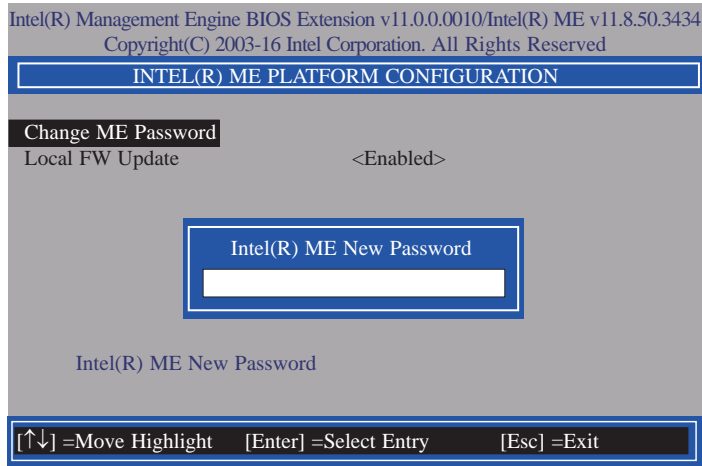

10. You will be asked to verify the new password. Enter the same new password in the space provided under Verify Password then press Enter.

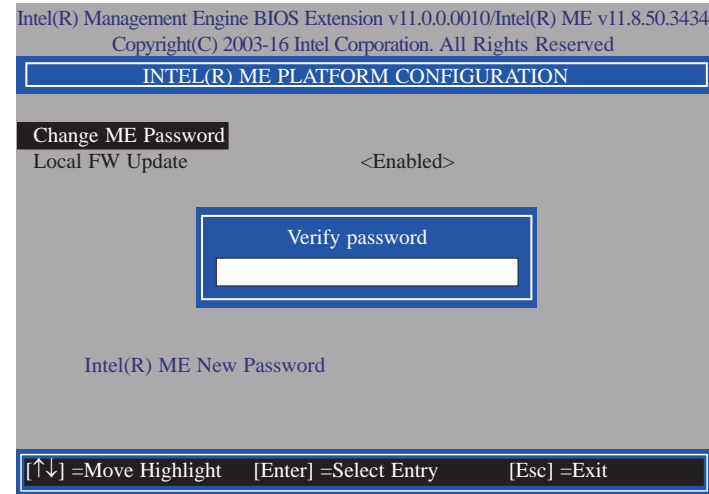

11. Select **Local FW Update** then press Enter. Select **Enabled** or **Disabled** or **Password Protected** then press Enter.

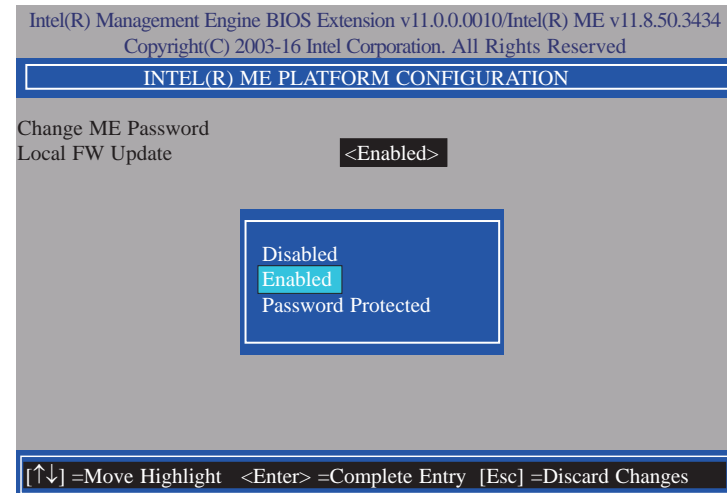

12. Press Esc until you return to the **Main Menu**. Select **Intel(R) Small Business Technology Configuration** then press Enter.

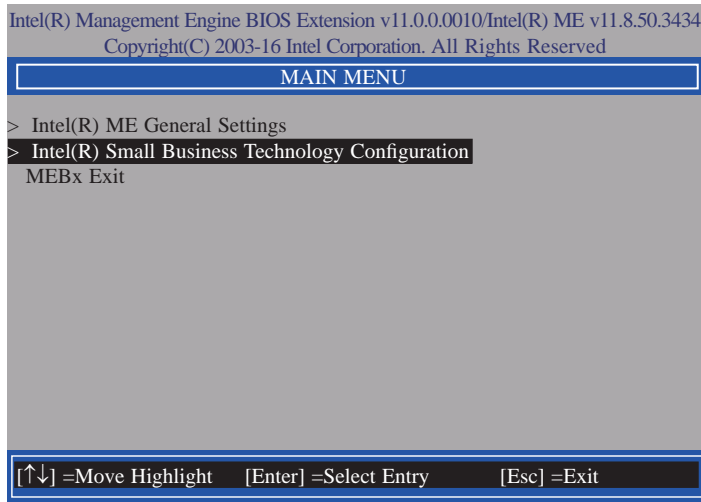

14. In the **Intel(R) Small Business Technology Configuration** menu, select **Restore Factory Settings** then press Enter.

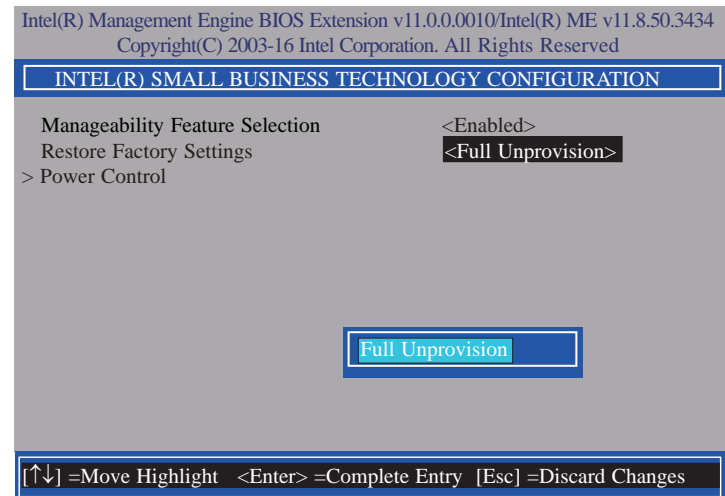

13. In the **Intel(R) Small Business Technology Configuration** menu, select **Manageability Feature Selection** then press Enter. Select **Enabled** or **Disabled** then press Enter.

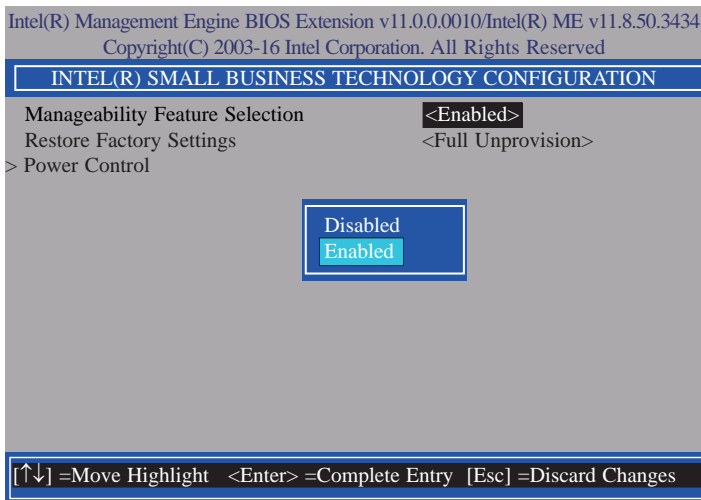

15. In the **Intel(R) Small Business Technology Configuration** menu, select **Power Control** then press Enter. In the **Intel(R) AMT Power Control** menu, select **Intel(R) AMT ON in Host Sleep States** then press Enter. Select an option then press Enter.

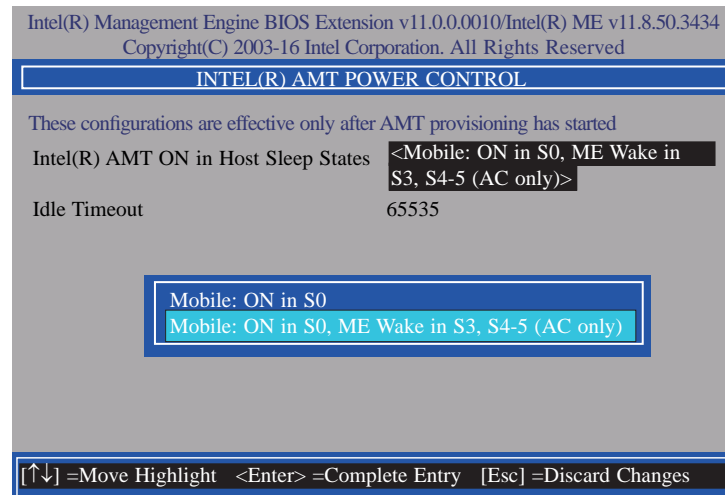

16. In the **Intel(R) AMT Power Control** menu, select **Idle Timeout** then press Enter. Enter the timeout value and press Enter.

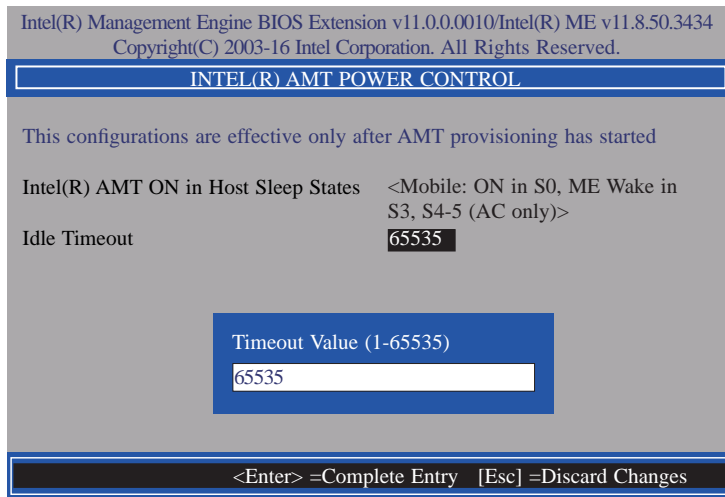

17. Press Esc until you return to the **Main Menu**. Select **MEBx Exit** then press Enter. Press Y to exit.

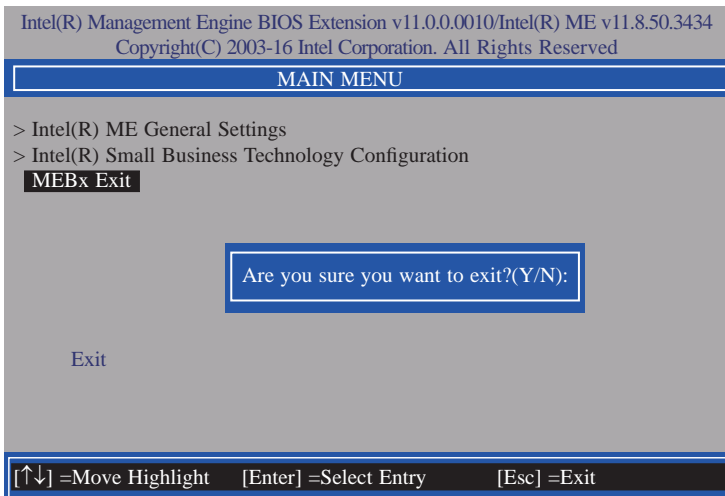

Appendix A - Troubleshooting Checklist

Troubleshooting Checklist

This chapter of the manual is designed to help you with problems that you may encounter with your personal computer. To efficiently troubleshoot your system, treat each problem individually. This is to ensure an accurate diagnosis of the problem in case a problem has multiple causes.

Some of the most common things to check when you encounter problems while using your system are listed below.

1. The power switch of each peripheral device is turned on.
2. All cables and power cords are tightly connected.
3. The electrical outlet to which your peripheral devices connected is working. Test the outlet by plugging in a lamp or other electrical device.
4. The monitor is turned on.
5. The display's brightness and contrast controls are adjusted properly.
6. All add-in boards in the expansion slots are seated securely.
7. Any add-in board you have installed is designed for your system and is set up correctly.

Monitor/Display

If the display screen remains dark after the system is turned on:

1. Make sure that the monitor's power switch is on.
2. Check that one end of the monitor's power cord is properly attached to the monitor and the other end is plugged into a working AC outlet. If necessary, try another outlet.
3. Check that the video input cable is properly attached to the monitor and the system's display adapter.
4. Adjust the brightness of the display by turning the monitor's brightness control knob.

The picture seems to be constantly moving.

1. The monitor has lost its vertical sync. Adjust the monitor's vertical sync.
2. Move away any objects, such as another monitor or fan, that may be creating a magnetic field around the display.
3. Make sure your video card's output frequencies are supported by this monitor.

The screen seems to be constantly wavering.

1. If the monitor is close to another monitor, the adjacent monitor may need to be turned off. Fluorescent lights adjacent to the monitor may also cause screen wavering.

Power Supply

When the computer is turned on, nothing happens.

1. Check that one end of the AC power cord is plugged into a live outlet and the other end properly plugged into the back of the system.
2. Make sure that the voltage selection switch on the back panel is set for the correct type of voltage you are using.
3. The power cord may have a "short" or "open". Inspect the cord and install a new one if necessary.

Hard Drive

Hard disk failure.

1. Make sure the correct drive type for the hard disk drive has been entered in the BIOS.
2. If the system is configured with two hard drives, make sure the bootable (first) hard drive is configured as Master and the second hard drive is configured as Slave. The master hard drive must have an active/bootable partition.

Excessively long formatting period.

If your hard drive takes an excessively long period of time to format, it is likely a cable connection problem. However, if your hard drive has a large capacity, it will take a longer time to format.

Serial Port

The serial device (modem, printer) doesn't output anything or is outputting garbled characters.

1. Make sure that the serial device's power is turned on and that the device is on-line.
2. Verify that the device is plugged into the correct serial port on the rear of the computer.
3. Verify that the attached serial device works by attaching it to a serial port that is working and configured correctly. If the serial device does not work, either the cable or the serial device has a problem. If the serial device works, the problem may be due to the onboard I/O or the address setting.
4. Make sure the COM settings and I/O address are configured correctly.

Keyboard

Nothing happens when a key on the keyboard was pressed.

1. Make sure the keyboard is properly connected.
2. Make sure there are no objects resting on the keyboard and that no keys are pressed during the booting process.

System Board

1. Make sure the add-in card is seated securely in the expansion slot. If the add-in card is loose, power off the system, re-install the card and power up the system.
2. Check the jumper settings to ensure that the jumpers are properly set.
3. Verify that all memory modules are seated securely into the memory sockets.
4. Make sure the memory modules are in the correct locations.
5. If the board fails to function, place the board on a flat surface and seat all socketed components. Gently press each component into the socket.
6. If you made changes to the BIOS settings, re-enter setup and load the BIOS defaults.