

EHL9A2

COM Express Mini Module
User's Manual

Copyright

This publication contains information that is protected by copyright. No part of it may be reproduced in any form or by any means or used to make any transformation/adaptation without the prior written permission from the copyright holders.

This publication is provided for informational purposes only. The manufacturer makes no representations or warranties with respect to the contents or use of this manual and specifically disclaims any express or implied warranties of merchantability or fitness for any particular purpose. The user will assume the entire risk of the use or the results of the use of this document. Further, the manufacturer reserves the right to revise this publication and make changes to its contents at any time, without obligation to notify any person or entity of such revisions or changes.

Changes after the publication's first release will be based on the product's revision. The website will always provide the most updated information.

© 2023. All Rights Reserved.

Trademarks

Product names or trademarks appearing in this manual are for identification purpose only and are the properties of the respective owners.

COM Express Specification Reference

PICMG® COM Express® Module Base Specification.
<http://www.picmg.org/>

FCC and DOC Statement on Class B

This equipment has been tested and found to comply with the limits for a Class B digital device, pursuant to Part 15 of the FCC rules. These limits are designed to provide reasonable protection against harmful interference when the equipment is operated in a residential installation. This equipment generates, uses and can radiate radio frequency energy and, if not installed and used in accordance with the instruction manual, may cause harmful interference to radio communications. However, there is no guarantee that interference will not occur in a particular installation. If this equipment does cause harmful interference to radio or television reception, which can be determined by turning the equipment off and on, the user is encouraged to try to correct the interference by one or more of the following measures:

- Reorient or relocate the receiving antenna.
- Increase the separation between the equipment and the receiver.
- Connect the equipment into an outlet on a circuit different from that to which the receiver is connected.
- Consult the dealer or an experienced radio TV technician for help.

Notice:

- The changes or modifications not expressly approved by the party responsible for compliance could void the user's authority to operate the equipment.
- Shielded interface cables must be used in order to comply with the emission limits.

Table of Contents

Chapter 1 - Introduction.....	6
Specification.....	6
Block Diagram.....	8
Chapter 2 - Concept.....	9
COM Express Module Standards.....	9
Chapter 3 - Hardware Installation.....	10
Board Layout.....	10
System Memory.....	10
Connector.....	11
COM Express Connector.....	11
System Memory.....	11
COM Express Connector Signal Description.....	13
COM Express Connector Signal Description.....	14
COM Express Connector Signal Description.....	15
COM Express Connector Signal Description.....	16
COM Express Connector Signal Description.....	17
COM Express Connector Signal Description.....	18
COM Express Connector Signal Description.....	19
COM Express Connector Signal Description.....	20
COM Express Connector Signal Description.....	21
COM Express Pin Assignments.....	22
Pin List for Pin-Out Type 10.....	22
Module Feature Fill Order.....	24
Feature Fill Order.....	24
Cooling Option.....	25
Heat Sink.....	25
Installing EHL9A2 onto a Carrier Board.....	25
Installing the COM Express Debug Card.....	26
COMe-DEBUG.....	27
Chapter 4 - BIOS Setup.....	29
Main.....	30
Advanced.....	30
RC ACPI Configuration.....	31
CPU Configuration.....	31
Power & Performance.....	32
PCH-FW Configuration.....	32
Intel(R) Time Coordinated Computing.....	33
Trusted Computing.....	34
PTN3460 Configuration.....	34
PC Health Status.....	35
DFI WDT Configuration.....	35
IT8528 Super IO Configuration.....	36
IT8528 Super IO Configuration ▶ Serial Port 1, 2 Configuration	36
Serial Port Console Redirection.....	37
Serial Port Console Redirection ▶ Console Redirection Settings	37
USB Configuration.....	38
Network Stack Configuration.....	38
Chipset.....	39
System Agent (SA) Configuration.....	39
System Agent (SA) Configuration ▶ Memory Configuration	40
System Agent (SA) Configuration ▶ Graphics Configuration	40

PCH-IO Configuration.....	41
PCH-IO Configuration ▶ PCI Express Configuration	41
PCH-IO Configuration ▶ SATA Configuration	42
PCH-IO Configuration ▶ Audio Configuration	42
Security.....	43
Secure Boot.....	43
Boot.....	44
Save & Exit.....	44
Updating the BIOS.....	45
Notice: BIOS SPI ROM.....	45

About this Manual

This manual can be downloaded from the website.

The manual is subject to change and update without notice, and may be based on editions that do not resemble your actual products. Please visit our website or contact our sales representatives for the latest editions.

Warranty

- Warranty does not cover damages or failures that occur from misuse of the product, inability to use the product, unauthorized replacement or alteration of components and product specifications.
- The warranty is void if the product has been subjected to physical abuse, improper installation, modification, accidents or unauthorized repair of the product.
- Unless otherwise instructed in this user's manual, the user may not, under any circumstances, attempt to perform service, adjustments or repairs on the product, whether in or out of warranty. It must be returned to the purchase point, factory or authorized service agency for all such work.
- We will not be liable for any indirect, special, incidental or consequential damages to the product that has been modified or altered.

Static Electricity Precautions

It is quite easy to inadvertently damage your PC, system board, components or devices even before installing them in your system unit. Static electrical discharge can damage computer components without causing any signs of physical damage. You must take extra care in handling them to ensure against electrostatic build-up.

- To prevent electrostatic build-up, leave the system board in its anti-static bag until you are ready to install it.
- Wear an antistatic wrist strap.
- Do all preparation work on a static-free surface.
- Hold the device only by its edges. Be careful not to touch any of the components, contacts or connections.
- Avoid touching the pins or contacts on all modules and connectors. Hold modules or connectors by their ends.



Important:

Electrostatic discharge (ESD) can damage your processor, disk drive and other components. Perform the upgrade instruction procedures described at an ESD workstation only. If such a station is not available, you can provide some ESD protection by wearing an antistatic wrist strap and attaching it to a metal part of the system chassis. If a wrist strap is unavailable, establish and maintain contact with the system chassis throughout any procedures requiring ESD protection.

Safety Measures

- To avoid damage to the system, use the correct AC input voltage range.
- To reduce the risk of electric shock, unplug the power cord before removing the system chassis cover for installation or servicing. After installation or servicing, cover the system chassis before plugging the power cord.

About the Package

The package contains the following items. If any of these items are missing or damaged, please contact your dealer or sales representative for assistance.

The accessories in the package may not come similar to the information listed below. This may differ in accordance with the sales region or models in which it was sold. For more information about the standard package in your region, please contact your dealer or sales representative.

- Heat Sink (For Pentium & Celeron)
- Cooler (For Atom x6000 Series)

Optional Items

The board and accessories in the package may not come similar to the information listed above. This may differ in accordance with the sales region or models in which it was sold. For more information about the standard package in your region, please contact your dealer or sales representative.

- Heat Spreader (For Atom x6000 Series)
- Heat Spreader (For Pentium & Celeron)
- COM100-B Carrier Board Kit
- COM335 Carrier Board Kit

Before Using the System Board

Before using the system board, prepare basic system components.

If you are installing the system board in a new system, you will need at least the following internal components.

- Storage devices such as hard disk drive, etc.

You will also need external system peripherals you intend to use which will normally include at least a keyboard, a mouse and a video display monitor.

Chapter 1 - Introduction

► Specification

SYSTEM	Processor	Intel Atom® x6000 series and Intel® Celeron® and Pentium® N & J series processors (formerly Code name “Elkhart Lake”)
	Memory	LPDDR4X max up to 16GB within dual channel and maximum speed depends on SOC. (The LPDDR4X speed ≤ 3733 MT/s (2RPC/1RPC) and 4267 MT/s (1RPC) which depends on processor.) Note: • 8GB/16GB supported by project basis. • In-band ECC (IBECC) with normal memory chip support on selected ATOM x6000 series SKUs. IBECC can set enabled or disabled in BIOS setup menu.
GRAPHICS	BIOS	AMI SPI 256Mbit
	Controller	Intel® HD Graphics
	Feature	OpenGL 5.0, DirectX 12, OpenCL 2.1 HW Decode: AVC/H.264, MPEG2, VC1, WMV9, JPEG/MJPEG, HEVC/H.265, VP8, VP9, MVC HW Encode: AVC/H.264, JPEG/MJPEG, HEVC/H.265, VP9, MVC
	Display	1 x DDI 1 x LVDS/eDP LVDS: single channel 24-bit, resolution up to 1920x1200 @ 60Hz eDP: resolution up to 4096x2160 @ 60Hz HDMI: resolution up to 4096x2160 @ 30Hz DP++: resolution up to 4096x2160 @ 60Hz, 3840x2160 @60Hz
EXPANSION	Interface	4 x PCIe x1 (Gen 3) 1 x SD/SDIO (available upon request) 1 x I2C 1 x SMBus 1 x LPC 1 x Speaker 1 x SPI 2 x UART (TX/RX)
AUDIO	Interface	HD Audio
ETHERNET	Controller	1 x Intel® I225IT / I225-LM (10/100/1000Mbps/2.5Gbps)
I/O	USB	2 x USB 3.1 Gen2 8 x USB 2.0
	SATA	2 x SATA 3.0 (up to 6Gb/s)
	eMMC	1 x 8GB/16GB/32GB/64GB*/128GB eMMC 5.1 (available upon request)
	DIO	1 x 8-bit DIO

WATCHDOG TIMER	Output & Interval	System Reset, Programmable via Software from 1 to 255 Seconds
SECURITY	TPM	dTPM or fTPM (Optional)
Power	Type	4.75V~20V, 5VSB, VCC_RTC (ATX mode) 4.75V~20V, VCC_RTC (AT mode)
	Consumption	TBD
OS SUPPORT	OS Support (UEFI Only)	Windows: Windows 10 IoT Enterprise 64-bit Linux
ENVIRONMENT	Temperature	Operating: -5 to 65°C, -40 to 85°C Storage: -40 to 85°C
	Humidity	Operating: 5 to 90% RH Storage: 5 to 90% RH
	MTBF	TBD
MECHANICAL	Dimensions	COM Express® Mini 84mm (3.3") x 55mm (2.16")
	Compliance	PICMG COM Express® R3.0, Type 10
STANDARDS AND CERTIFICATIONS	Certification	CE, FCC

► Block Diagram

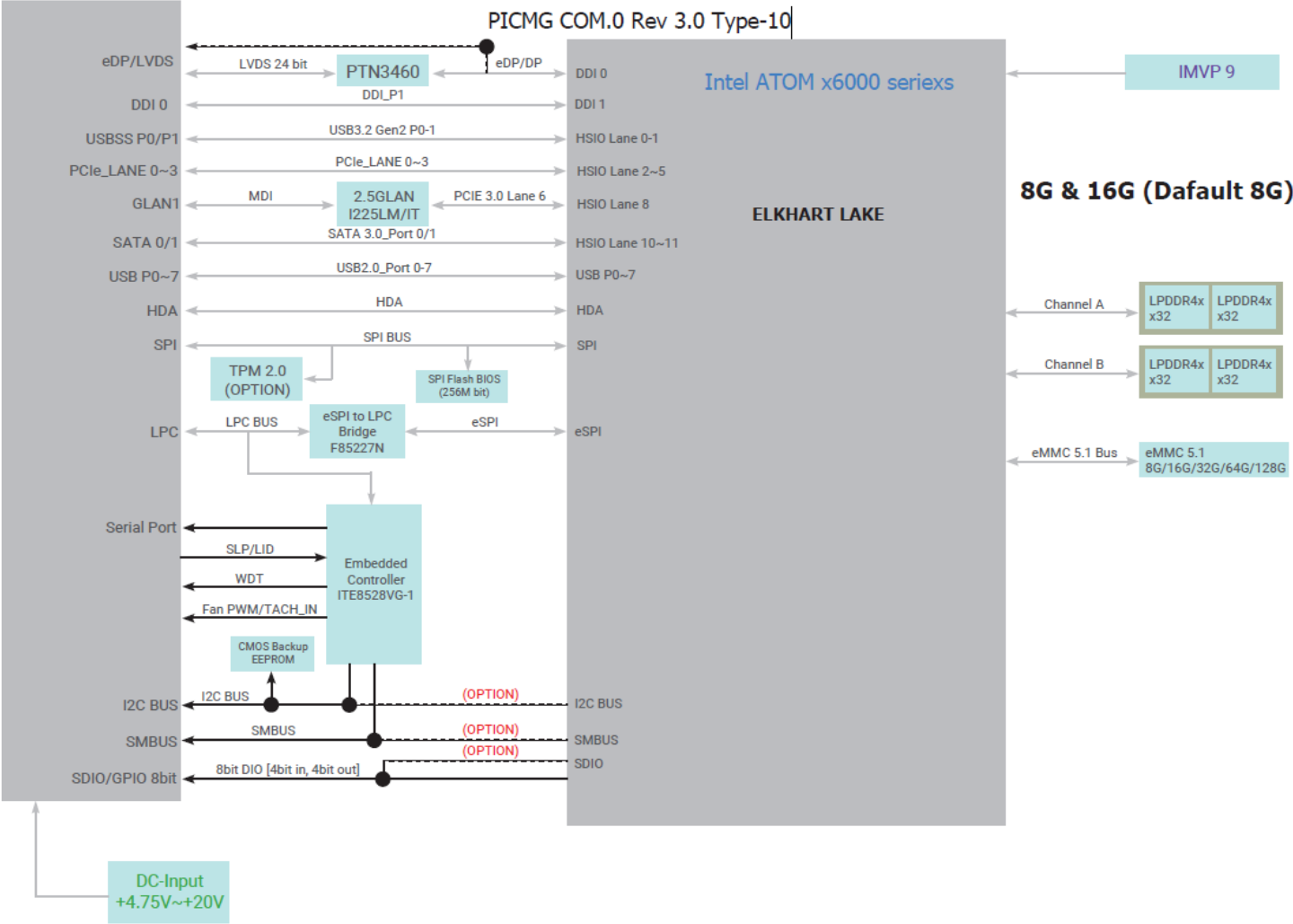

Chapter 2 - Concept

► COM Express Module Standards

The figure below shows the dimensions of the different types of COM Express modules.
 EHL9A2 is a COM Express Mini. The dimension is 84mm x 55mm.

- Common for all Form Factors
- Extended only
- Basic only
- Compact only
- Compact and Basic only
- Mini only

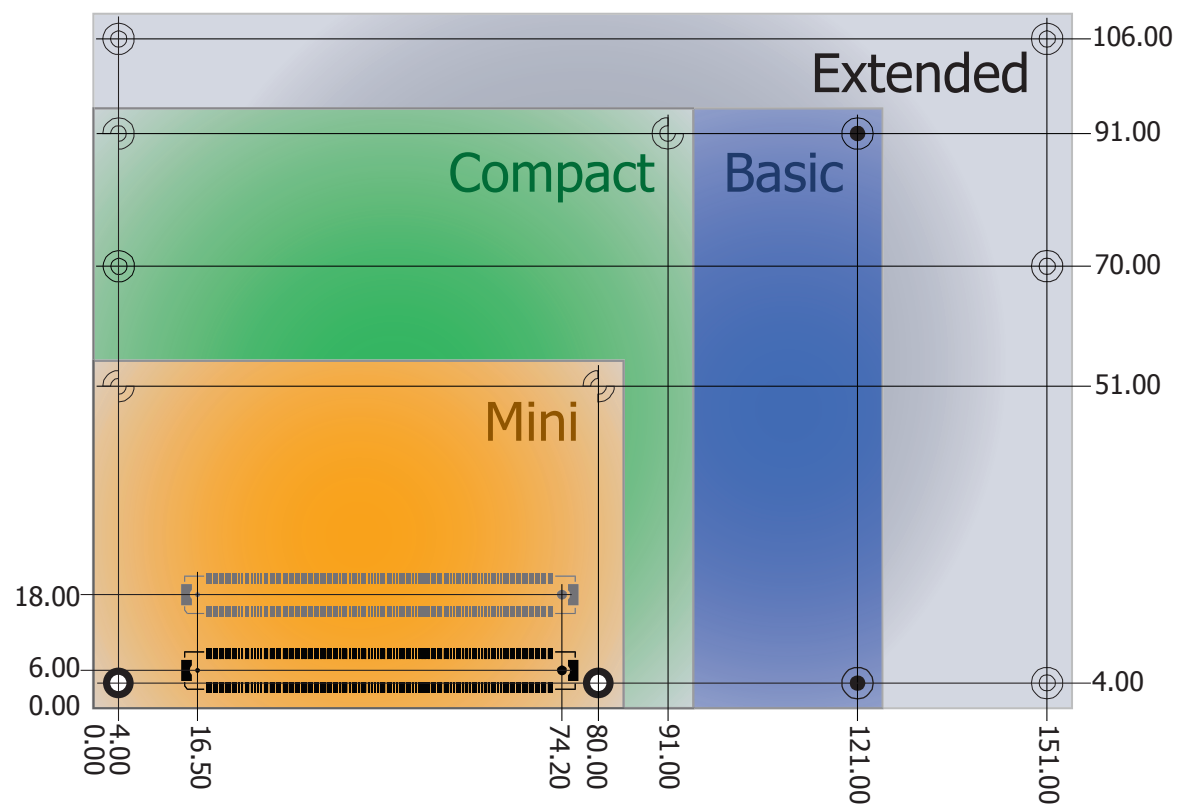

Chapter 3 - Hardware Installation

► Board Layout

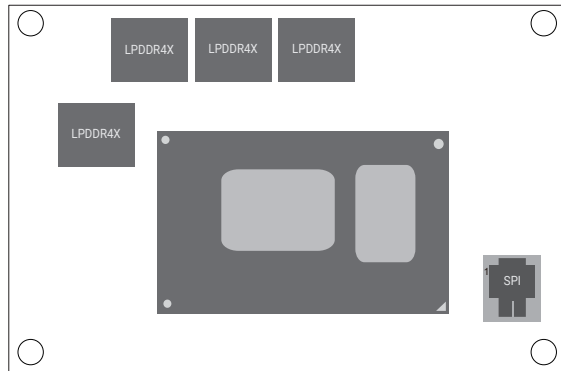

TOP VIEW

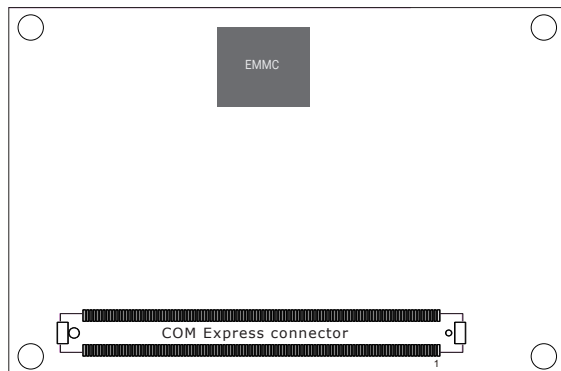

BOTTOM VIEW

► System Memory

The system board is equipped with LPDDR4X memory chips onboard.

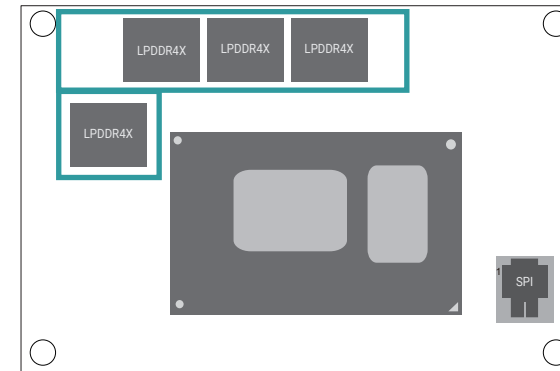

Important:

Boards, and other components. Perform installation procedures at an ESD workstation only. If such a station is not available, you can provide some ESD protection by wearing an antistatic wrist strap and attaching it to a metal part of the system chassis. If a wrist strap is unavailable, establish and maintain contact with the system chassis throughout any procedures requiring ESD protection.

► Connector

COM Express Connector

The COM Express connector is used to interface the EHL9A2 COM Express board to a carrier board. Connect the COM Express connector (located on the solder side of the board) to the COM Express connector on the carrier board. Refer to the following pages for the pin functions of the connector.

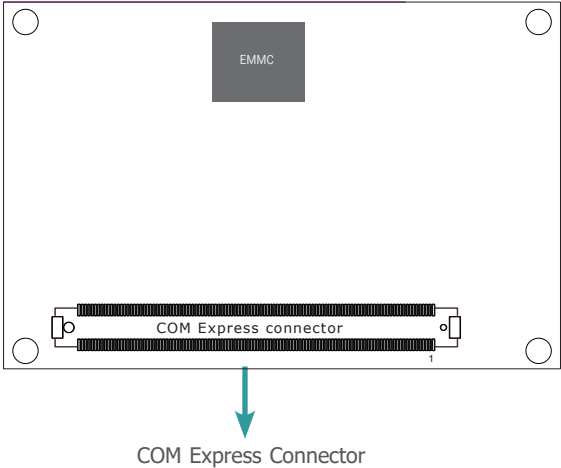

The table below shows the COM Express standard specifications and the corresponding specifications supported on the EHL9A2 module. Type 10 Modules support a single 24 bit LVDS panel interface, a single DDI and an eDP overlaid on LVDS Channel A. Two of the 8 USB ports can be used as USB 3.0.

Connector	Feature	"Type 10 Min / Max"	"DFI Type 10 EHL9A2 (000G)"
• System I/O			
A-B	PCI Express Lanes 0 - 3	1 / 4	4
A-B	NC-SI	NA	NA
A-B	1Gb LAN Port 0	1 / 1	1
A-B	DDI 0	0 / 1	1
A-B	DDIs 1 - 3	NA	NA
A-B	LVDS Channel A	0 / 1	1
A-B	LVDS Channel B	NA	NA
A-B	eDP on LVDS CH A pins	0 / 1	1
A-B	VGA Port	NA	NA
A-B	Serial Ports 1 - 2	0 / 2	2
A-B	CAN interface on SER1	0 / 1	0
A-B	SATA Ports	1 / 2	2
A-B	HDA Digital Interface	0 / 1	2
A-B	USB 2.0 Ports	4 / 8	8
A-B	USB0 Client	0 / 1	0
A-B	USB7 Client	0 / 1	0
A-B	USB 3.0 Ports	0 / 2	2
A-B	LPC Bus or eSPI	1 / 1	1 LPC
A-B	SPI (Devices)	1 / 2	2

Connector	Feature	"Type 10 Min / Max"	"DFI Type 10 EHL9A2 (000G)"
• System Management			
A-B ⁶	SDIO (muxed on GPIO)	0 / 1	1 (BOM option with 8 bit DIO)
A-B	General Purpose I/O	8 / 8	8
A-B	SMBus	1 / 1	1
A-B	I2C	1 / 1	1
A-B	Watchdog Timer	0 / 1	1
A-B	Speaker Out	1 / 1	1
A-B	Carrier Board BIOS Flash Support	0 / 1	1
A-B	Reset Functions	1 / 1	1
A-B	Trusted Platform Module	0 / 1	1
• Power Management			
A-B	Thermal Protection	0 / 1	1
A-B	Battery Low Alarm	0 / 1	1
A-B	Suspend/Wake Signals	0 / 3	2
A-B	Power Button Support	1 / 1	1
A-B	Power Good	1 / 1	1
A-B	VCC_5V_SBY Contacts	4 / 4	4
A-B ⁵	Sleep Input	0 / 1	1
A-B ⁵	Lid Input	0 / 1	1
A-B ⁵	Carrier Board Fan Control	0 / 1	1
• Power			
A-B	VCC_12V Contacts	12 / 12	12



Note for A-B⁵ :

These signals use reclaimed VCC_12V pins. Refer to Module base specification Section 5.8 'Protecting COM.0 Pins Reclaimed from the VCC_12V Pool' for additional design considerations.



Note for A-B⁶ :

Cells in the connected columns spanning rows provide a rough approximation of features sharing connector pins.

► **COM Express Connector Signal Description**

Pin Types

- I : Input to the Module
- O : Output from the Module
- I/O : Bi-directional input / output signal
- OD : Open drain output
- RSVD : pins are reserved for future use and should be no connect. Do not tie the RSVD pins together.

HDA Signals Descriptions						
Signal	Pin#	Pin Type	Pwr Rail /Tolerance	EHL9A2 PU/PD	Module Base Specification R3.0 Description	COM Express Carrier Design Guide R2.0 Description
HDA_RST#	A30	O CMOS	3.3V Suspend/3.3V	series 33Ω resistor	Reset output to CODEC, active low.	CODEC Reset.
HDA_SYNC	A29	O CMOS	3.3V/3.3V	series 33Ω resistor	Sample-synchronization signal to the CODEC(s).	Serial Sample Rate Synchronization.
HDA_BITCLK	A32	I/O CMOS	3.3V/3.3V	series 33Ω resistor	Serial data clock generated by the external CODEC(s).	24 MHz Serial Bit Clock for HDA CODEC.
HDA_SDOUT	A33	O CMOS	3.3V/3.3V	series 33Ω resistor	Serial TDM data output to the CODEC.	Audio Serial Data Output Stream.
HDA_SDIN0	B30	I/O CMOS	3.3V Suspend/3.3V		Serial TDM data inputs from up to 3 CODECs.	Audio Serial Data Input Stream from CODEC[0:2].
HDA_SDIN1	B29	I/O CMOS	3.3V Suspend/3.3V			
HDA_SDIN2	B28	I/O CMOS	3.3V Suspend/3.3V	NC		
Gigabit Ethernet Signals Descriptions						
Signal	Pin#	Pin Type	Pwr Rail /Tolerance	EHL9A2 PU/PD	Module Base Specification R3.0 Description	COM Express Carrier Design Guide R2.0 Description
GBE0_MDIO+	A13	I/O Analog	3.3V max Suspend		Gigabit Ethernet Controller 0: Media Dependent Interface Differential Pairs 0,1,2,3. The MDI can operate in 1000, 100 and 10 Mbit / sec modes. Some pairs are unused in some modes, per the following: <div style="display: flex; justify-content: space-around; font-size: small;"> 1000BASE-T 100BASE-TX 10BASE-T </div> MDI[0]+/- B1_DA+/- TX+/- TX+/- MDI[1]+/- B1_DB+/- RX+/- RX+/- MDI[2]+/- B1_DC+/- MDI[3]+/- B1_DD+/-	Media Dependent Interface (MDI) differential pair 0.
GBE0_MDIO-	A12	I/O Analog	3.3V max Suspend			Media Dependent Interface (MDI) differential pair 1.
GBE0_MD11+	A10	I/O Analog	3.3V max Suspend			Media Dependent Interface (MDI) differential pair 2. Only used for 1000Mbit/sec Gigabit Ethernet mode.
GBE0_MD11-	A9	I/O Analog	3.3V max Suspend			Media Dependent Interface (MDI) differential pair 3. Only used for 1000Mbit/sec Gigabit Ethernet mode.
GBE0_MD12+	A7	I/O Analog	3.3V max Suspend			
GBE0_MD12-	A6	I/O Analog	3.3V max Suspend			
GBE0_MD13+	A3	I/O Analog	3.3V max Suspend			
GBE0_MD13-	A2	I/O Analog	3.3V max Suspend			
GBE0_ACT#	B2	OD CMOS	3.3V Suspend/3.3V		Gigabit Ethernet Controller 0 activity indicator, active low.	Ethernet controller 0 activity indicator, active low.
GBE0_LINK#	A8	OD CMOS	3.3V Suspend/3.3V	Only at Pin A4 or A5 link speed the GBE0_LINK# will active low.	Gigabit Ethernet Controller 0 link indicator, active low.	Ethernet controller 0 link indicator, active low.
GBE0_LINK100#	A4	OD CMOS	3.3V Suspend/3.3V	LED for link speed with 1Gbps.	Gigabit Ethernet Controller 0 100 Mbit / sec link indicator, active low.	Ethernet controller 0 100Mbit/sec link indicator, active low.
GBE0_LINK1000#	A5	OD CMOS	3.3V Suspend/3.3V	LED for link speed with 2.5Gbps	Gigabit Ethernet Controller 0 1000 Mbit / sec link indicator, active low.	Ethernet controller 0 1000Mbit/sec link indicator, active low.
GBE0_CTREF	A14	REF	GND min, 3.3V max	NC	Reference voltage for Carrier Board Ethernet channel 0 magnetics center tap. The reference voltage is determined by the requirements of the Module PHY and may be as low as 0V and as high as 3.3V. The reference voltage output shall be current limited on the Module. In the case in which the reference is shorted to ground, the current shall be limited to 250 mA or less.	Reference voltage for Carrier Board Ethernet channel 0 magnetics center tap.
GBE0_SDP	A49	I/O	3.3V Suspend/3.3V		Gigabit Ethernet Controller 0 Software-Definable Pin. Can also be used for IEEE1588 support such as a 1pps signal.	
SATA Signals Descriptions						
Signal	Pin#	Pin Type	Pwr Rail /Tolerance	EHL9A2 PU/PD	Module Base Specification R3.0 Description	COM Express Carrier Design Guide R2.0 Description
SATA0_TX+	A16	O SATA	AC coupled on Module	AC Coupling capacitor	Serial ATA or SAS Channel 0 transmit differential pair.	Serial ATA channel 0 Transmit output differential pair.
SATA0_TX-	A17	O SATA	AC coupled on Module	AC Coupling capacitor		Serial ATA channel 0 Receive input differential pair.
SATA0_RX+	A19	I SATA	AC coupled on Module	AC Coupling capacitor	Serial ATA or SAS Channel 1 transmit differential pair.	Serial ATA channel 1 Transmit output differential pair.
SATA0_RX-	A20	I SATA	AC coupled on Module	AC Coupling capacitor		Serial ATA channel 1 Receive input differential pair.
SATA1_TX+	B16	O SATA	AC coupled on Module	AC Coupling capacitor	Serial ATA (activity indicator), active low.	Serial ATA activity LED. Open collector output pin driven during SATA command activity.
SATA1_TX-	B17	O SATA	AC coupled on Module	AC Coupling capacitor		
SATA1_RX+	B19	I SATA	AC coupled on Module	AC Coupling capacitor		
SATA1_RX-	B20	I SATA	AC coupled on Module	AC Coupling capacitor		
(S)ATA_ACT#	A28	I/O CMOS	3.3V / 3.3V	Single buffer		

► COM Express Connector Signal Description

PCI Express Lanes Signals Descriptions						
Signal	Pin#	Pin Type	Pwr Rail /Tolerance	EHL9A2 PU/PD	Module Base Specification R3.0 Description	COM Express Carrier Design Guide R2.0 Description
PCIE_TX0+	A68	O PCIE	AC coupled on Module	AC Coupling capacitor	PCI Express Differential Transmit Pairs 0	PCIE channel 0. Transmit Output differential pair.
PCIE_TX0-	A69			AC Coupling capacitor		
PCIE_RX0+	B68	I PCIE	AC coupled off Module		PCI Express Differential Receive Pairs 0	PCIE channel 0. Receive Input differential pair.
PCIE_RX0-	B69					
PCIE_TX1+	A64	O PCIE	AC coupled on Module	AC Coupling capacitor	PCI Express Differential Transmit Pairs 1	PCIE channel 1. Transmit Output differential pair.
PCIE_TX1-	A65			AC Coupling capacitor		
PCIE_RX1+	B64	I PCIE	AC coupled off Module		PCI Express Differential Receive Pairs 1	PCIE channel 1. Receive Input differential pair.
PCIE_RX1-	B65					
PCIE_TX2+	A61	O PCIE	AC coupled on Module	AC Coupling capacitor	PCI Express Differential Transmit Pairs 2	PCIE channel 2. Transmit Output differential pair.
PCIE_TX2-	A62			AC Coupling capacitor		
PCIE_RX2+	B61	I PCIE	AC coupled off Module		PCI Express Differential Receive Pairs 2	PCIE channel 2. Receive Input differential pair.
PCIE_RX2-	B62					
PCIE_TX3+	A58	O PCIE	AC coupled on Module	AC Coupling capacitor	PCI Express Differential Transmit Pairs 3	PCIE channel 3. Transmit Output differential pair.
PCIE_TX3-	A59			AC Coupling capacitor		
PCIE_RX3+	B58	I PCIE	AC coupled off Module		PCI Express Differential Receive Pairs 3	PCIE channel 3. Receive Input differential pair.
PCIE_RX3-	B59					
PCIE_CLK_REF+	A88	O PCIE	PCIE		Reference clock output for all PCI Express and PCI Express Graphics lanes.	PCIE Reference Clock for all COM Express PCIE lanes, and for PEG lanes.
PCIE_CLK_REF-	A89					

Note: For PCIE device down or slot card components on the carrier board, please use the PCIE Lane0 port first.

USB Signals Descriptions						
Signal	Pin#	Pin Type	Pwr Rail /Tolerance	EHL9A2 PU/PD	Module Base Specification R3.0 Description	COM Express Carrier Design Guide R2.0 Description
USB0+	A46	I/O USB	3.3V Suspend/3.3V		USB differential pairs, channel 0. If implemented, shall be host ports.	USB Port 0, data + or D+
USB0-	A45					USB Port 0, data - or D-
USB1+	B46	I/O USB	3.3V Suspend/3.3V		USB differential pairs, channel 1. If implemented, shall be host ports.	USB Port 1, data + or D+
USB1-	B45					USB Port 1, data - or D-
USB2+	A43	I/O USB	3.3V Suspend/3.3V		USB differential pairs, channel 2. If implemented, shall be host ports.	USB Port 2, data + or D+
USB2-	A42					USB Port 2, data - or D-
USB3+	B43	I/O USB	3.3V Suspend/3.3V		USB differential pairs, channel 3. If implemented, shall be host ports.	USB Port 3, data + or D+
USB3-	B42					USB Port 3, data - or D-
USB4+	A40	I/O USB	3.3V Suspend/3.3V		USB differential pairs, channel 4. If implemented, shall be host ports.	USB Port 4, data + or D+
USB4-	A39					USB Port 4, data - or D-
USB5+	B40	I/O USB	3.3V Suspend/3.3V		USB differential pairs, channel 5. If implemented, shall be host ports.	USB Port 5, data + or D+
USB5-	B39					USB Port 5, data - or D-
USB6+	A37	I/O USB	3.3V Suspend/3.3V		USB differential pairs, channel 6. If implemented, shall be host ports.	USB Port 6, data + or D+
USB6-	A36					USB Port 6, data - or D-
USB7+	B37	I/O USB	3.3V Suspend/3.3V		USB differential pairs, channel 7. If implemented, shall be host ports.	USB Port 7, data + or D+
USB7-	B36					USB Port 7, data - or D-
USB_0_1_OC#	B44	I CMOS	3.3V Suspend/3.3V	PU 10K Ω to 3.3V Suspend	USB over-current sense, USB channels 0 and 1. A pull-up for this line shall be present on the Module. An open drain driver from a USB current monitor on the Carrier Board may drive this line low. Do not pull this line high on the Carrier Board.	USB over-current sense, USB ports 0 and 1. Do not pull up these lines to 3.3V on the Carrier Board – this shall be done on the Module.

► COM Express Connector Signal Description

USB_2_3_OC#	A44	I CMOS	3.3V Suspend/3.3V	PU 10KΩ to 3.3V Suspend	USB over-current sense, USB channels 2 and 3. A pull-up for this line shall be present on the Module. An open drain driver from a USB current monitor on the Carrier Board may drive this line low. Do not pull this line high on the Carrier Board.	USB over-current sense, USB ports 2 and 3. Do not pull up these lines to 3.3V on the Carrier Board – this shall be done on the Module.
USB_4_5_OC#	B38	I CMOS	3.3V Suspend/3.3V	PU 10KΩ to 3.3V Suspend	USB over-current sense, USB channels 4 and 5. A pull-up for this line shall be present on the Module. An open drain driver from a USB current monitor on the Carrier Board may drive this line low. Do not pull this line high on the Carrier Board.	USB over-current sense, USB ports 4 and 5. Do not pull up these lines to 3.3V on the Carrier Board – this shall be done on the Module.
USB_6_7_OC#	A38	I CMOS	3.3V Suspend/3.3V	PU 10KΩ to 3.3V Suspend	USB over-current sense, USB channels 6 and 7. A pull-up for this line shall be present on the Module. An open drain driver from a USB current monitor on the Carrier Board may drive this line low. Do not pull this line high on the Carrier Board.	USB over-current sense, USB ports 6 and 7. Do not pull up these lines to 3.3V on the Carrier Board – this shall be done on the Module.
USB_SSTX0+	B23	O PCIE	AC coupled on Module	AC Coupling capacitor	Additional transmit signal differential pairs for the SuperSpeed USB data path.	USB Port 0, SuperSpeed TX +
USB_SSTX0-	B22			AC Coupling capacitor		USB Port 0, SuperSpeed TX -
USB_SSRX0+	A23	I PCIE	AC coupled off Module		Additional receive signal differential pairs for the SuperSpeed USB data path.	USB Port 0, SuperSpeed RX +
USB_SSRX0-	A22					USB Port 0, SuperSpeed RX -
USB_SSTX1+	B26	O PCIE	AC coupled on Module	AC Coupling capacitor	Additional transmit signal differential pairs for the SuperSpeed USB data path.	USB Port 1, SuperSpeed TX +
USB_SSTX1-	B25			AC Coupling capacitor		USB Port 1, SuperSpeed TX -
USB_SSRX1+	A26	I PCIE	AC coupled off Module		Additional receive signal differential pairs for the SuperSpeed USB data path.	USB Port 1, SuperSpeed RX +
USB_SSRX1-	A25					USB Port 1, SuperSpeed RX -
USB0_HOST_PRSNT	B48	I CMOS	3.3V Suspend/3.3V	N.C.	Module USB client may detect the presence of a USB host on USB0. A high value indicates that a host is present.	
USB7_HOST_PRSNT	B96	I CMOS	3.3V Suspend/3.3V	N.C.	Module USB client may detect the presence of a USB host on USB7. A high value indicates that a host is present.	

LVDS Signals Descriptions

Signal	Pin#	Pin Type	Pwr Rail /Tolerance	EHL9A2 PU/PD	Module Base Specification R3.0 Description	COM Express Carrier Design Guide R2.0 Description
LVDS_A0+/eDP_TX2+	A71	O LVDS	LVDS EDP: AC coupled off Module		LVDS Channel A differential pairs eDP: eDP differential pairs	LVDS channel A differential signal pair 0 eDP lane 2, TX± differential signal pair
LVDS_A0-/eDP_TX2-	A72					
LVDS_A1+/eDP_TX1+	A73	O LVDS	LVDS EDP: AC coupled off Module			LVDS channel A differential signal pair 1 eDP lane 1, TX± differential signal pair
LVDS_A1-/eDP_TX1-	A74					
LVDS_A2+/eDP_TX0+	A75	O LVDS	LVDS EDP: AC coupled off Module			LVDS channel A differential signal pair 2 eDP lane 0, TX± differential signal pair
LVDS_A2-/eDP_TX0-	A76					
LVDS_A3+	A78	O LVDS	LVDS EDP: AC coupled off Module			LVDS channel A differential signal pair 3
LVDS_A3-	A79					
LVDS_A_CK+/eDP_TX3+	A81	O LVDS	LVDS EDP: AC coupled off Module		LVDS Channel A differential clock eDP: eDP differential pairs	LVDS channel A differential clock pair eDP lane 3, TX± differential pair
LVDS_A_CK-/eDP_TX3-	A82					

► **COM Express Connector Signal Description**

LVDS_VDD_EN/eDP_VDD_EN	A77	O CMOS	3.3V / 3.3V	PD 100KΩ to GND	LVDS panel / eDP power enable	LVDS flat panel power enable. eDP power enable
LVDS_BKLT_EN/eDP_BKLT_EN	B79	O CMOS	3.3V / 3.3V	PD 100KΩ to GND	LVDS panel / eDP backlight enable	LVDS flat panel backlight enable high active signal eDP backlight enable
LVDS_BKLT_CTRL/eDP_BKLT_CTRL	B83	O CMOS	3.3V / 3.3V	PD 100KΩ to GND	LVDS panel / eDP backlight brightness control	LVDS flat panel backlight brightness control eDP backlight brightness control
LVDS_I2C_CLK/eDP_AUX+	A83	I/O OD CMOS	3.3V / 3.3V	PU 4.7KΩ to 3.3V	I2C clock output for LVDS display use / eDP AUX+	DDC I2C clock signal used for flat panel detection and control. eDP auxiliary lane +
LVDS_I2C_DAT/eDP_AUX-	A84	I/O OD CMOS	3.3V / 3.3V	PU 4.7KΩ to 3.3V	I2C data line for LVDS display use / eDP AUX-	DDC I2C data signal used for flat panel detection and control. eDP auxiliary lane -
RSVD/eDP_HPD	A87	I CMOS	3.3V / 3.3V	eDP: PD 100KΩ to GND	eDP_HPD:Detection of Hot Plug / Unplug and notification of the link layer	eDP_HPD: Detection of Hot Plug / Unplug and notification of the link layer

LPC Signals Descriptions

Signal	Pin#	Pin Type	Pwr Rail /Tolerance	EHL9A2 PU/PD (LPC mode only.)	Module Base Specification R3.0 Description	COM Express Carrier Design Guide R2.0 Description
LPC_AD0/ESPI_IO_0	B4	I/O CMOS	LPC: 3.3V / 3.3V ESPI: 1.8V Suspend / 1.8V		LPC mode: LPC multiplexed address, command and data bus. ESPI mode: eSPI Master Data Input / Outputs These are bi-directional input/output pins used to transfer data between master and slaves.	LPC multiplexed command, address and data.
LPC_AD1/ESPI_IO_1	B5					
LPC_AD2/ESPI_IO_2	B6					
LPC_AD3/ESPI_IO_3	B7					
LPC_FRAME#/ESPI_CS0#	B3	O CMOS	LPC: 3.3V / 3.3V ESPI: 1.8V Suspend / 1.8V		LPC mode: LPC frame indicates the start of an LPC cycle. ESPI Mode: eSPI Master Chip Select Outputs Driving Chip Select0#. A low selects a particular eSPI slave for the transaction. Each of the eSPI slaves is connected to a dedicated Chip Selectn# pin.	LPC frame indicates start of a new cycle or termination of a broken cycle.
LPC_DRQ0#/ESPI_ALERT0#	B8	I CMOS	LPC: 3.3V / 3.3V ESPI: 1.8V Suspend / 1.8V	PU 10K to 3.3V, not used.	LPC mode: LPC serial DMA request ESPI Mode: eSPI pins used by eSPI slave to request service from the eSPI master.	LPC encoded DMA/Bus master request.
LPC_DRQ1#/ESPI_ALERT1#	B9			PU 10K to 3.3V, not used.		
LPC_SERIRQ/ESPI_CS1#	A50	I/O CMOS O CMOS	LPC: 3.3V / 3.3V ESPI: 1.8V Suspend / 1.8V	PU 10K to 3.3V	LPC mode: LPC serial interrupt ESPI Mode: eSPI Master Chip Select Outputs Driving Chip Select# A low selects a particular eSPI slave for the transaction. Each of the eSPI slaves is connected to a dedicated Chip Selectn# pin.	LPC serialized IRQ.
LPC_CLK/ESPI_CLK	B10	O CMOS	LPC: 3.3V / 3.3V ESPI: 1.8V Suspend / 1.8V	series 33Ω resistor (32MHz)	LPC mode: LPC clock output - 33MHz nominal ESPI Mode: eSPI Master Clock Output This pin provides the reference timing for all the serial input and output operations.	LPC clock output 33MHz.
SUS_STAT#/ESPI_RESET#	B18	O CMOS	LPC: 3.3V / 3.3V ESPI: 1.8V Suspend / 1.8V	PU 10K to 3.3V Suspend.	LPC Mode: SUS_STAT# indicates imminent suspend operation. It is used to notify LPC devices that a low power state will be entered soon. ESPI Mode: eSPI Reset Reset the eSPI interface for both master and slaves. eSPI Reset# is typically driven from eSPI master to eSPI slaves.	Suspend status signal to indicate that the system will be entering a low power state soon. It can be used by other peripherals on the Carrier Board as an indication that they should go into power-down mode.
ESPI_EN#	B47	I CMOS	NA	N.C.	This signal is used by the Carrier to indicate the operating mode of the LPC/eSPI bus. If left unconnected on the carrier, LPC mode (default) is selected. If pulled to GND on the carrier, eSPI mode is selected. This signal is pulled to a logic high on the module through a resistor. The Carrier should only float this line or pull it low.	

SPI Signals Descriptions

Signal	Pin#	Pin Type	Pwr Rail /Tolerance	EHL9A2 PU/PD	Module Base Specification R3.0 Description	COM Express Carrier Design Guide R2.0 Description
SPI_CS#	B97	O CMOS	3.3V Suspend/3.3V		Chip select for Carrier Board SPI - may be sourced from chipset SPI0 or SPI1	Chip select for Carrier Board SPI – may be sourced from chipset SPI0 or SPI1
SPI_MISO	A92	I CMOS	3.3V Suspend/3.3V		Data in to Module from Carrier SPI	Data in to Module from Carrier SPI
SPI_MOSI	A95	O CMOS	3.3V Suspend/3.3V		Data out from Module to Carrier SPI	Data out from Module to Carrier SPI

► COM Express Connector Signal Description

SPI_CLK	A94	O CMOS	3.3V Suspend/3.3V		Clock from Module to Carrier SPI	Clock from Module to Carrier SPI
SPI_POWER	A91	O	3.3V Suspend/3.3V		Power supply for Carrier Board SPI – sourced from Module – nominally 3.3V. The Module shall provide a minimum of 100mA on SPI_POWER. Carriers shall use less than 100mA of SPI_POWER. SPI_POWER shall only be used to power SPI devices on the Carrier Board.	Power supply for Carrier Board SPI – sourced from Module – nominally 3.3V. The Module shall provide a minimum of 100mA on SPI_POWER. Carriers shall use less than 100mA of SPI_POWER. SPI_POWER shall only be used to power SPI devices on the Carrier.
BIOS_DIS0#	A34	I CMOS	NA	PU 10KΩ to 3V3 Suspend.	Selection straps to determine the BIOS boot device. The Carrier should only float these or pull them low, please refer to Table 4.13 for strapping options of BIOS disable signals.	Selection strap to determine the BIOS boot device. The Carrier should only float these or pull them low, please refer to for strapping options of BIOS disable signals.
BIOS_DIS1#	B88			PU 10KΩ to 3V3 Suspend.	Selection strap to determine the BIOS boot device. The Carrier should only float these or pull them low.	

DDI Signals Descriptions						
Signal	Pin#	Pin Type	Pwr Rail /Tolerance	EHL9A2 PU/PD	Module Base Specification R3.0 Description	COM Express Carrier Design Guide R2.0 Description
DDIO_PAIR0+	B71	O PCIE	AC coupled off Module		DDI for Display Port: DP0_LANE 0 differential pairs Uni-directional main link for the transport of isochronous streams and secondary data packets.	DP1_LANE0+ for DP / TMDS1_DATA2+ for HDMI or DVI
DDIO_PAIR0-	B72				DDI for HDMI/DVI: TMDS0_DATA lanes 2 differential pairs	DP1_LANE0- for DP / TMDS1_DATA2- for HDMI or DVI
DDIO_PAIR1+	B73	O PCIE	AC coupled off Module		DDI for Display Port: DP0_LANE 1 differential pairs Uni-directional main link for the transport of isochronous streams and secondary data packets.	DP1_LANE1+ for DP / TMDS1_DATA1+ for HDMI or DVI
DDIO_PAIR1-	B74				DDI for HDMI/DVI: TMDS0_DATA lanes 1 differential pairs	DP1_LANE1- for DP / TMDS1_DATA1- for HDMI or DVI
DDIO_PAIR2+	B75	O PCIE	AC coupled off Module		DDI for Display Port: DP0_LANE 2 differential pairs Uni-directional main link for the transport of isochronous streams and secondary data packets.	DP1_LANE2+ for DP / TMDS1_DATA0+ for HDMI or DVI
DDIO_PAIR2-	B76				DDI for HDMI/DVI: TMDS0_DATA lanes 0 differential pairs	DP1_LANE2- for DP / TMDS1_DATA0- for HDMI or DVI
DDIO_PAIR3+	B81	O PCIE	AC coupled off Module		DDI for Display Port: DP0_LANE 3 differential pairs Uni-directional main link for the transport of isochronous streams and secondary data packets.	DP1_LANE3+ for DP / TMDS1_CLK+
DDIO_PAIR3-	B82				DDI for HDMI/DVI: TMDS0_CLK differential pairs	DP1_LANE3- for DP / TMDS1_CLK-
DDIO_PAIR4+	B77	I PCIE	AC coupled off Module	NC		NA
DDIO_PAIR4-	B78					NA
DDIO_PAIR5+	B91	I PCIE	AC coupled off Module	NC		NA
DDIO_PAIR5-	B92					NA
DDIO_PAIR6+	B93	I PCIE	AC coupled off Module	NC		NA
DDIO_PAIR6-	B94					NA
DDIO_CTRLCLK_AUX+	B98	I/O PCIE	AC coupled on Module	PD 100KΩ to GND (S/W IC between Rpu/PCH)	DDI for Display Port: DP0_AUX+ Differential pairs (DP AUX+ function if DDIO_DDC_AUX_SEL is no connect) Half-duplex bi-directional AUX channel for services such as link configuration or maintenance and EDID access	DP1_AUX+ for DP
		I/O OD CMOS	3.3V / 3.3V	PU 2.2KΩ to 3.3V, PD 100KΩ to GND (S/W IC between AB Rpu/Rpd resistor)	DDI for HDMI/DVI: HDMI0_CTRL_CLK (HDMI/DVI I2C CTRLCLK if DDIO_DDC_AUX_SEL is pulled high)	HDMI1_CTRLCLK for HDMI or DVI
DDIO_CTRLCLK_AUX-	B99	I/O PCIE	AC coupled on Module	PU 100K to 3.3V (S/W IC between Rpu/PCH)	DDI for Display Port: DP0_AUX- Differential pairs (DP AUX- function if DDIO_DDC_AUX_SEL is no connect) Half-duplex bi-directional AUX channel for services such as link configuration or maintenance and EDID access	DP1_AUX- for DP

► COM Express Connector Signal Description

		I/O OD CMOS	3.3V / 3.3V	PU 2.2K to 3.3V/PU 100K to 3.3V (S/W IC between AB Rpu/Rpd resistor)	DDI for HDMI/DVI: HDMI0_CTRL_DATA (HDMI/DVI I2C CTRLDATA if DDI0_DDC_AUX_SEL is pulled high)	HDMI1_CTRLDATA for HDMI or DVI
DDI0_HPD	B89	I CMOS	3.3V / 3.3V	PD 100KΩ to GND	DDI for Display Port: DP0_HPD (Detection of Hot Plug / Unplug and notification of the link layer) DDI for HDMI/DVI: HDMI0_HPD (HDMI/DVI Hot-Plug Detect)	DP1_HPD for DP / HDMI1_HPD for HDMI or DVI. When carriers that support TMDS(HDMI/DVI), the Carrier shall include a blocking FET on DDI0_HPD to prevent back-drive current from damaging the Module.
DDI0_DDC_AUX_SEL	B95	I CMOS	3.3V / 3.3V	PD 1MΩ to GND	Selects the function of DDI0_CTRLCLK_AUX+ and DDI0_CTRLDATA_AUX-. This pin shall have a 1M pull-down to logic ground on the Module. If this input is unconnected the AUX pair is used for the DP AUX+/- signals. If pulled-high the AUX pair contains the CTRLCLK and CTRLDATA signals.	Selects the function of DP1_AUX±(Low) or HDMI1 DDC CLK/DATA(High) The DDC_AUX_SEL pin should be routed to pin 13 of the DisplayPort connector, to enable Dual-Mode DisplayPort interface. When HDMI/DVI is directly done on the Carrier Board, this pin shall be pulled to 3.3V with a 100k Ohm resistor to configure the DDI[0]_AUX pairs as DDC channels.
Serial Interface Signals Descriptions						
Signal	Pin#	Pin Type	Pwr Rail /Tolerance	EHL9A2 PU/PD	Module Base Specification R3.0 Description	COM Express Carrier Design Guide R2.0 Description
SER0_TX	A98	O CMOS	3.3V/12V		General purpose serial port 0 transmitter	Transmit Line for Serial Port 0 ; PD 4.7KΩ
SER0_RX	A99	I CMOS	3.3V/12V	PU 10KΩ to 3.3V	General purpose serial port 0 receiver	Receive Line for Serial Port 0
SER1_TX	A101	O CMOS	3.3V/12V		General purpose serial port 1 transmitter	Transmit Line for Serial Port 1 ; PD 4.7KΩ
SER1_RX	A102	I CMOS	3.3V/12V	PU 10KΩ to 3.3V	General purpose serial port 1 receiver	Receive Line for Serial Port 1
I2C Signal Descriptions						
Signal	Pin#	Pin Type	Pwr Rail /Tolerance	EHL9A2 PU/PD	Module Base Specification R3.0 Description	COM Express Carrier Design Guide R2.0 Description
I2C_CK	B33	I/O OD CMOS	3.3V Suspend/3.3V	PU 2.2K to 3.3V Suspend	General purpose I2C port clock output	General Purpose I2C Clock output
I2C_DAT	B34	I/O OD CMOS	3.3V Suspend/3.3V	PU 2.2K to 3.3V Suspend	General purpose I2C port data I/O line	General Purpose I2C data I/O line.
Miscellaneous Signal Descriptions						
Signal	Pin#	Pin Type	Pwr Rail /Tolerance	EHL9A2 PU/PD	Module Base Specification R3.0 Description	COM Express Carrier Design Guide R2.0 Description
SPKR	B32	O CMOS	3.3V / 3.3V		Output for audio enunciator - the "speaker" in PC-AT systems. This port provides the PC beep signal and is mostly intended for debugging purposes.	Output used to control an external FET or a logic gate to drive an external PC speaker.
WDT	B27	O CMOS	3.3V / 3.3V		Output indicating that a watchdog time-out event has occurred.	Output indicating that a watchdog time-out event has occurred.
FAN_PWMOUT	B101	O CMOS	3.3V / 12V	RSV PD 100KΩ to GND	Fan speed control. Uses the Pulse Width Modulation (PWM) technique to control the fan's RPM.	Fan speed control. Uses the Pulse Width Modulation (PWM) technique to control the fan's RPM.
FAN_TACHIN	B102	I OD CMOS	3.3V / 12V	PU 47KΩ to 3.3V	Fan tachometer input for a fan with a two pulse output.	Fan tachometer input for a fan with a two pulse output.
TPM_PP	A96	I CMOS	3.3V / 3.3V	PD 100KΩ to GND.	Trusted Platform Module (TPM) Physical Presence pin. Active high. TPM chip has an internal pull down. This signal is used to indicate Physical Presence to the TPM.	Trusted Platform Module (TPM) Physical Presence pin. Active high. TPM chip has an internal pull down. This signal is used to indicate Physical Presence to the TPM.

► COM Express Connector Signal Description

Power and System Management Signals Descriptions						
Signal	Pin#	Pin Type	Pwr Rail /Tolerance	EHL9A2 PU/PD	Module Base Specification R3.0 Description	COM Express Carrier Design Guide R2.0 Description
PWRBTN#	B12	I CMOS	3.3V Suspend/3.3V	PU 10K Ω to 3.3V Suspend	A falling edge creates a power button event. Power button events can be used to bring a system out of S5 soft off and other suspend states, as well as powering the system down.	Power button low active signal used to wake up the system from S5 state (soft off). This signal is triggered on the falling edge.
SYS_RESET#	B49	I CMOS	3.3V Suspend/3.3V	PU 10K Ω to 3.3V Suspend	Reset button input. Active low request for Module to reset and reboot. May be falling edge sensitive. For situations when SYS_RESET# is not able to reestablish control of the system, PWR_OK or a power cycle may be used.	Reset button input. Active low request for Module to reset and reboot. May be falling edge sensitive. For situations when SYS_RESET# is not able to reestablish control of the system, PWR_OK or a power cycle may be used.
CB_RESET#	B50	O CMOS	3.3V Suspend/3.3V	AND gate out with series 33 Ω resistor	Reset output from Module to Carrier Board. Active low. Issued by Module chipset and may result from a low SYS_RESET# input, a low PWR_OK input, a VCC_12V power input that falls below the minimum specification, a watchdog timeout, or may be initiated by the Module software.	Reset output signal from Module to Carrier Board. This signal may be driven low by the Module to reset external components located on the Carrier Board.
PWR_OK	B24	I CMOS	3.3V / 3.3V	PU 10K Ω to 5V and PD 20K Ω that divide to 3.3V.	Power OK from main power supply. A high value indicates that the power is good. This signal can be used to hold off Module startup to allow Carrier based FPGAs or other configurable devices time to be programmed.	Power OK status signal generated by the ATX power supply to notify the Module that the DC operating voltages are within the ranges required for proper operation.
SUS_STAT#	B18	O CMOS	3.3V Suspend/3.3V	PU 10K to 3.3V Suspend.	Indicates imminent suspend operation; used to notify LPC devices.	Suspend status signal to indicate that the system will be entering a low power state soon. It can be used by other peripherals on the Carrier Board as an indication that they should go into power-down mode.
SUS_S3#	A15	O CMOS	3.3V Suspend/3.3V	PD 100K Ω to GND	Indicates system is in Suspend to RAM state. Active low output. An inverted copy of SUS_S3# on the Carrier Board may be used to enable the non-standby power on a typical ATX supply.	S3 Sleep control signal indicating that the system resides in S3 state (Suspend to RAM).
SUS_S4#	A18	O CMOS	3.3V Suspend/3.3V	PD 100K Ω to GND	Indicates system is in Suspend to Disk state. Active low output.	S4 Sleep control signal indicating that the system resides in S4 state (Suspend to Disk).
SUS_S5#	A24	O CMOS	3.3V Suspend/3.3V	PD 100K Ω to GND	Indicates system is in Soft Off state.	S5 Sleep Control signal indicating that the system resides in S5 State (Soft Off).
WAKE0#	B66	I CMOS	3.3V Suspend/3.3V	PU 10K Ω to 3.3V Suspend	PCI Express wake up signal.	PCI Express wake-up event signal.
WAKE1#	B67	I CMOS	3.3V Suspend/3.3V	PU 10K Ω to 3.3V Suspend	General purpose wake up signal. May be used to implement wake-up on PS2 keyboard or mouse activity.	General purpose wake-up signal.
BATLOW#	A27	I CMOS	3.3V Suspend/3.3V	PU 10K Ω to 3.3V Suspend	Indicates that external battery is low. This port provides a battery-low signal to the Module for orderly transitioning to power saving or power cut-off ACPI modes.	Battery low input. This signal may be driven low by external circuitry to signal that the system battery is low. It also can be used to signal some other external power management event.
LID#	A103	I OD CMOS	3.3V Suspend/12V	PU 47K Ω to 3.3V Suspend	LID switch. Low active signal used by the ACPI operating system for a LID switch.	LID switch. Low active signal used by the ACPI operating system for a LID switch.
SLEEP#	B103	I OD CMOS	3.3V Suspend/12V	PU 47K Ω to 3.3V Suspend	Sleep button. Low active signal used by the ACPI operating system to bring the system to sleep state or to wake it up again.	Sleep button. Low active signal used by the ACPI operating system to bring the system to sleep state or to wake it up again.

Thermal Protection Signals Descriptions						
Signal	Pin#	Pin Type	Pwr Rail /Tolerance	EHL9A2 PU/PD	Module Base Specification R3.0 Description	COM Express Carrier Design Guide R2.0 Description
THRM#	B35	I CMOS	3.3V / 3.3V	PU 10K Ω to 3.3V	Input from off-Module temp sensor indicating an over-temp situation.	Thermal Alarm active low signal generated by the external hardware to indicate an over temperature situation. This signal can be used to initiate thermal throttling.
THRMTRIP#	A35	O CMOS	3.3V / 3.3V	PU 10K Ω to 3.3V	Active low output indicating that the CPU has entered thermal shutdown.	Thermal Trip indicates an overheating condition of the processor. If 'THRMTRIP#' goes active the system immediately transitions to the S5 State (Soft Off).

► **COM Express Connector Signal Description**

SMBUS Signals Descriptions						
Signal	Pin#	Pin Type	Pwr Rail /Tolerance	EHL9A2 PU/PD	Module Base Specification R3.0 Description	COM Express Carrier Design Guide R2.0 Description
SMB_CK	B13	I/O OD CMOS	3.3V Suspend/3.3V	PU 2.2K Ω to 3.3V Suspend	System Management Bus bidirectional clock line.	System Management Bus bidirectional clock line
SMB_DAT	B14	I/O OD CMOS	3.3V Suspend/3.3V	PU 2.2K Ω to 3.3V Suspend	System Management Bus bidirectional data line.	System Management bidirectional data line.
SMB_ALERT#	B15	I CMOS	3.3V Suspend/3.3V	PU 2.2K Ω to 3.3V Suspend	System Management Bus Alert – active low input can be used to generate an SMI# (System Management Interrupt) or to wake the system.	System Management Bus Alert

GPIO Signals Descriptions						
Signal	Pin#	Pin Type	Pwr Rail /Tolerance	EHL9A2 PU/PD	Module Base Specification R3.0 Description	COM Express Carrier Design Guide R2.0 Description
GPO0/SD_CLK	A93	O CMOS	3.3V / 3.3V		GPIO: General purpose output pins. Upon a hardware reset, these outputs should be low. SDIO: SDIO Clock. With each cycle of this signal a one-bit transfer on the command and each data line occurs. This signal has maximum frequency of 48 Mhz. Maps to GPO0.	General Purpose Outputs for system specific usage.
GPO1/SD_CMD	B54	O CMOS			GPIO: General purpose output pins. Upon a hardware reset, these outputs should be low. SDIO: SDIO Command/Response. This signal is used for card initialization and for command transfers. During initialization mode this signal is open drain. During command transfer this signal is in push-pull mode. Maps to GPO1.	
GPO2/SD_WP	B57	O CMOS / I CMOS			GPIO: General purpose output pins. Upon a hardware reset, these outputs should be low. SDIO: SDIO Write Protect. This signal denotes the state of the write-protect tab on SD cards. Maps to GPO2; used as an input when used for SD card support.	
GPO3/SD_CD#	B63	O CMOS / I CMOS			GPIO: General purpose output pins. Upon a hardware reset, these outputs should be low. SDIO: SDIO Card Detect. This signal indicates when a SDIO/MMC card is present. Maps to GPO3; used as an input when used for SD card support.	
GPI0/SD_DATA0	A54	I CMOS / IO CMOS	3.3V / 3.3V	PU 47K Ω to 3.3V @GPI	GPIO: General purpose input pins. Pulled high internally on the Module. SDIO: SDIO Data lines. These signals operate in push-pull mode. Maps to GPI[0:3].	General Purpose Input for system specific usage. The signals are pulled up by the Module.
GPI1/SD_DATA1	A63	I CMOS / IO CMOS		PU 47K Ω to 3.3V @GPI		
GPI2/SD_DATA2	A67	I CMOS / IO CMOS		PU 47K Ω to 3.3V @GPI		
GPI3/SD_DATA3	A85	I CMOS / IO CMOS		PU 47K Ω to 3.3V @GPI		

► **COM Express Connector Signal Description**

Power and GND Signal Descriptions						
Signal	Pin#	Pin Type	Pwr Rail /Tolerance	EHL9A2 PU/PD	Module Base Specification R2.1 Description	COM Express Carrier Design Guide R2.0 Description
VCC_12V	A104~A109 B104~B109	Power			Primary power input supports wide range 4.75V ~ 20V voltage input. All available VCC_12V pins on the connector(s) shall be used.	
VCC_5V_SBY	B84~B87	Power			Standby power input: +5.0V nominal. If VCC5_SBY is used, all available VCC_5V_SBY pins on the connector(s) shall be used. Only used for standby and suspend functions. May be left unconnected if these functions are not used in the system design.	
VCC_RTC	A47	Power			Real-time clock circuit-power input. Nominally +3.0V.	Battery cells must be protected against a reverse current going to the cell. For revision 2.0 Carrier Boards, a protection low leakage diode and/or a series resistor shall be placed on the Carrier Board.
GND	A1, A11, A21, A31, A41, A51, A57, A60, A66, A70, A80, A90, A100, A110, B1, B11, B21 ,B31, B41, B51, B60, B70, B80, B90, B100, B110	Power			Ground - DC power and signal and AC signal return path. All available GND connector pins shall be used and tied to Carrier Board GND plane.	

Module type Signal Descriptions						
Signal	Pin#	Pin Type	Pwr Rail /Tolerance	EHL9A2 PU/PD	Module Base Specification R3.0 Description	COM Express Carrier Design Guide R2.0 Description
TYPE10#	A97	PDS		PD 47K	Dual use pin. Indicates to the Carrier Board that a Type 10 Module is installed. Indicates to the Carrier that a Rev 1.0/2.0 Module is installed TYPE10# NC Pin-out R2.0 PD Pin-out Type 10 pull down to ground with 47K resistor 12V Pin-out R1.0 This pin is reclaimed from the VCC_12V pool. In R1.0 Modules this pin will connect to other VCC_12V pins. In R2.0 this pin is defined as a no connect for types 1-6. A Carrier can detect a R1.0 Module by the presence of 12V on this pin. R2.0 Module types 1-6 will no connect this pin. Type 10 Modules shall pull this pin to ground through a 47K resistor.	Indicates to the Carrier Board that a Type 10 Module is installed. Indicates to the Carrier Board, that a Rev 1.0/2.0 Module is installed. TYPE10# NC Pin-out R2.0 PD Pin-out Type 10 pull down to ground with 47k 12V Pin-out R1.0

► COM Express Pin Assignments

Pin List for Pin-Out Type 10

The table below is a comprehensive list of all signal pins supported on the single 220-pin COM Express connectors as defined for Type 10 in the PICMG COM.0 R3.0 specification.

Pin	Row A	"EHL9A2 Difference"	Row B	"EHL9A2 Difference"
1	GND(FIXED)		GND(FIXED)	
2	GBE0_MDI3-		GBE0_ACT#	
3	GBE0_MDI3+		LPC_FRAME#	
4	GBE0_LINK100#	GBE1_LED1000#	LPC_AD0	
5	GBE0_LINK1000#	GBE1_LED2500#	LPC_AD1	
6	GBE0_MDI2-		LPC_AD2	
7	GBE0_MDI2+		LPC_AD3	
8	GBE0_LINK#		LPC_DRQ0#	PU 10K to 3.3V
9	GBE0_MDI1-		LPC_DRQ1#	PU 10K to 3.3V
10	GBE0_MDI1+		LPC_CLK	
11	GND(FIXED)		GND(FIXED)	
12	GBE0_MDI0-		PWRBTN#	
13	GBE0_MDI0+		SMB_CK	
14	GBE0_CTREF	NC	SMB_DAT	
15	SUS_S3#		SMB_ALERT#	
16	SATA0_TX+		SATA1_TX+	
17	SATA0_TX-		SATA1_TX-	
18	SUS_S4#		SUS_STAT#	PU 10K to 3.3VSB
19	SATA0_RX+		SATA1_RX+	
20	SATA0_RX-		SATA1_RX-	
21	GND(FIXED)		GND(FIXED)	
22	USB_SSRX0-		USB_SSTX0-	
23	USB_SSRX0+		USB_SSTX0+	
24	SUS_S5#		PWR_OK	
25	USB_SSRX1-		USB_SSTX1-	
26	USB_SSRX1+		USB_SSTX1+	

Pin	Row A	"EHL9A2 Difference"	Row B	"EHL9A2 Difference"
27	BATLOW#		WDT	
28	(S)ATA_ACT#		HDA_SDIN2	NC
29	HDA_SYNC		HDA_SDIN1	
30	HDA_RST#		HDA_SDIN0	
31	GND(FIXED)		GND(FIXED)	
32	HDA_BITCLK		SPKR	
33	HDA_SDOUT		I2C_CK	
34	BIOS_DIS0#		I2C_DAT	
35	THRMTRIP#		THRM#	
36	USB6-		USB7-	
37	USB6+		USB7+	
38	USB_6_7_OC#		USB_4_5_OC#	
39	USB4-		USB5-	
40	USB4+		USB5+	
41	GND(FIXED)		GND(FIXED)	
42	USB2-		USB3-	
43	USB2+		USB3+	
44	USB_2_3_OC#		USB_0_1_OC#	
45	USB0-		USB1-	
46	USB0+		USB1+	
47	VCC_RTC		ESPI_EN#	NC
48	RSVD		USB0_HOST_PRSNT	NC
49	GBE0_SDP		SYS_RESET#	
50	LPC_SERIRQ		CB_RESET#	
51	GND(FIXED)		GND(FIXED)	
52	RSVD		RSVD	
53	RSVD		RSVD	
54	GPI0/SD_DATA0**		GPO1/SD_CMD**	
55	RSVD		RSVD	
56	RSVD		RSVD	

Pin	Row A	"EHL9A2 Difference"	Row B	"EHL9A2 Difference"
57	GND		GPO2/SD_WP**	
58	PCIE_TX3+		PCIE_RX3+	
59	PCIE_TX3-		PCIE_RX3-	
60	GND(FIXED)		GND(FIXED)	
61	PCIE_TX2+		PCIE_RX2+	
62	PCIE_TX2-		PCIE_RX2-	
63	GPI1/SD_DATA1**		GPO3/SD_CD#**	
64	PCIE_TX1+		PCIE_RX1+	
65	PCIE_TX1-		PCIE_RX1-	
66	GND		WAKE0#	
67	GPI2/SD_DATA2**		WAKE1#	
68	PCIE_TX0+		PCIE_RX0+	
69	PCIE_TX0-		PCIE_RX0-	
70	GND(FIXED)		GND(FIXED)	
71	LVDS_A0+/eDP_TX2+**		DDIO_PAIR0+	
72	LVDS_A0-/eDP_TX2-**		DDIO_PAIR0-	
73	LVDS_A1+/eDP_TX1+**		DDIO_PAIR1+	
74	LVDS_A1-/eDP_TX1-**		DDIO_PAIR1-	
75	LVDS_A2+/eDP_TX0+**		DDIO_PAIR2+	
76	LVDS_A2-/eDP_TX0-**		DDIO_PAIR2-	
77	LVDS_VDD_EN/eDP_VDD_EN**		DDIO_PAIR4+	NC
78	LVDS_A3+		DDIO_PAIR4-	NC
79	LVDS_A3-		LVDS_BKLT_EN/eDP_BKLT_EN**	
80	GND(FIXED)		GND(FIXED)	
81	LVDS_A_CK+/eDP_TX3+**		DDIO_PAIR3+	
82	LVDS_A_CK-/eDP_TX3-**		DDIO_PAIR3-	
83	LVDS_I2C_CK/eDP_AUX+**		LVDS_BKLT_TRL/eDP_BKLT_CTRL**	
84	LVDS_I2C_DAT/eDP_AUX-**		VCC_5V_SBY	
85	GPI3/SD_DATA3**		VCC_5V_SBY	
86	RSVD		VCC_5V_SBY	

Pin	Row A	"EHL9A2 Difference"	Row B	"EHL9A2 Difference"
87	eDP_HPD**		VCC_5V_SBY	
88	PCIE_CLK_REF+		BIOS_DIS1#	
89	PCIE_CLK_REF-		DDIO_HPD	
90	GND(FIXED)		GND(FIXED)	
91	SPI_POWER		DDIO_PAIR5+	NC
92	SPI_MISO		DDIO_PAIR5-	NC
93	GPO0/SD_CLK**		DDIO_PAIR6+	NC
94	SPI_CLK		DDIO_PAIR6-	NC
95	SPI_MOSI		DDIO_DDC_AUX_SEL	
96	TPM_PP		USB7_HOST_PRSENT	NC
97	TYPE10#		SPI_CS#	
98	SER0_TX		DDIO_CTRLCLK_AUX+	
99	SER0_RX		DDIO_CTRLDATA_AUX-	
100	GND(FIXED)		GND(FIXED)	
101	SER1_TX		FAN_PWMOUT	
102	SER1_RX		FAN_TACHIN	
103	LID#		SLEEP#	
104	VCC_12V		VCC_12V	
105	VCC_12V		VCC_12V	
106	VCC_12V		VCC_12V	
107	VCC_12V		VCC_12V	
108	VCC_12V		VCC_12V	
109	VCC_12V		VCC_12V	
110	GND(FIXED)		GND(FIXED)	

**Note:**

- ** eDP (in place of LVDS) is BOM option supported by project basis.
- ** SD (in place of GPIO) is BOM option supported by project basis.
- EHL9A2 (Mini module) allows wide range input voltage with 4.75V to 20V from VCC_12V power pins.
- For PCIe device down components on the carrier board, please use and place on the PCIe Lane0 port first.

► **Module Feature Fill Order**

Feature Fill Order

COM Express allows a variable number of ports to be implemented for several interfaces,

Feature	Number of Ports	Fill Order
LAN	1	GbE channel 0
LVDS	Single Channel	LVDS channel A
SATA	2	SATA channels 0,1
USB 2.0 Host	4	USB channels 0,1,2,3
	5	USB channels 0,1,2,3,4
	6	USB channels 0,1,2,3,4,5
	7	USB channels 0,1,2,3,4,5,6
	8	USB channels 0,1,2,3,4,5,6,7
USB 2.0 Client	1	USB Channel 7 only (Option for static changing, select the USB2.0 port client port in the BIOS setup and reset the BIOS)
USB 3.0 SuperSpeed²	1	USB channel 0
	2	USB channels 0,1
DDI	1	DDI 1

► Cooling Option

Heat Sink

The COM Express connector is used to interface the EHL9A2 COM Express board to a carrier board. Connect the COM Express connector (located on the solder side of the board) to the COM Express connector on the carrier board.



Top View of the Heat Sink

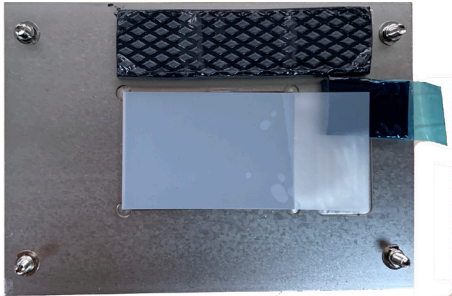

Bottom View of the Heat Sink



Important: Remove the plastic covering from the thermal pads prior to mounting the heat sink onto board.

► Installing EHL9A2 onto a Carrier Board



Important: The carrier board (COM335) used in this section is for reference purpose only and may not resemble your carrier board. These illustrations are mainly to guide you on how to install EHL9A2 onto the carrier board of your choice.

1. Grasp EHL9A2 by its edges and position it on top of the carrier board with its COM Express connector aligned with the COM Express connector on the carrier board. This will also help align the mounting holes of EHL9A2 with the standoffs on the carrier board.

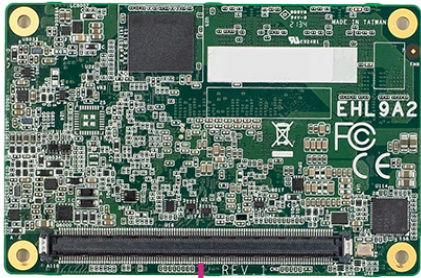

COM Express connector

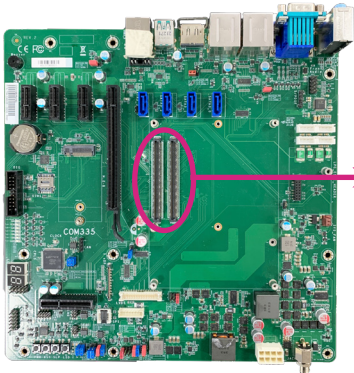

COM Express connector on the carrier board

- 2. Apply firm even pressure to the side with the COM Express connector first and push down the entire module. Be careful when pressing the module to avoid damaging it. You will hear a distinctive "click", indicating the module is correctly locked into position.

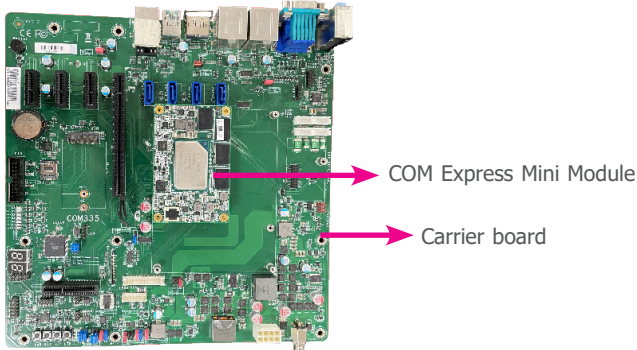

- 3. Align the mounting holes of the heatsink with the mounting holes of the module. Use the provided mounting screws to install the heat sink onto the module.

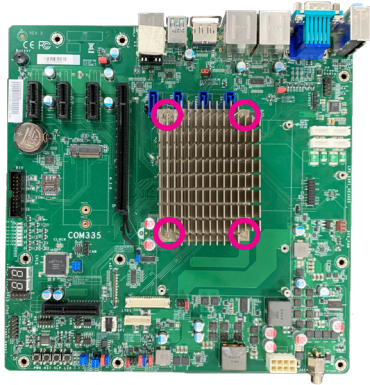

► Installing the COM Express Debug Card

- 1. COMe-LINK2 is the COM Express debug platform installed into COM Express Mini modules for the application of debugging and displaying signals and codes.
- 2. Connect the COMe-DEBUG card to COMe-LINK2 via a cable.

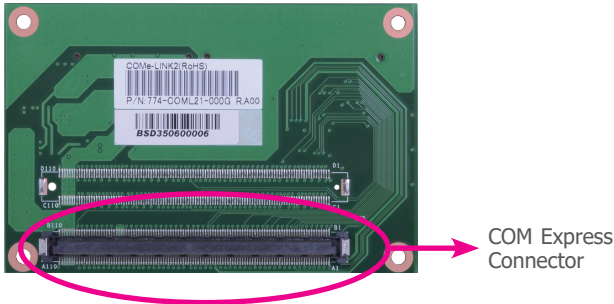
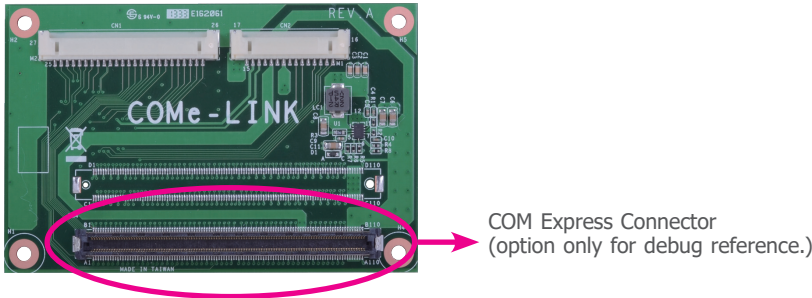

Note:
The system board used in the following illustrations may not resemble the actual board. These illustrations are for reference only.

COMe-DEBUG

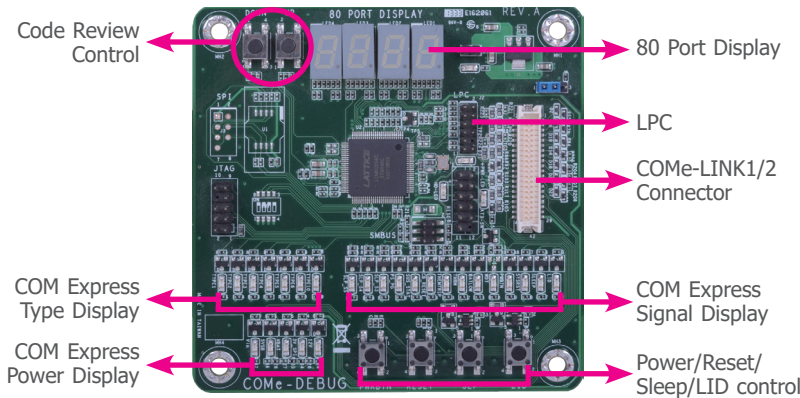

3. Fasten bolts with mounting screws through mounting holes to be fixed in place.

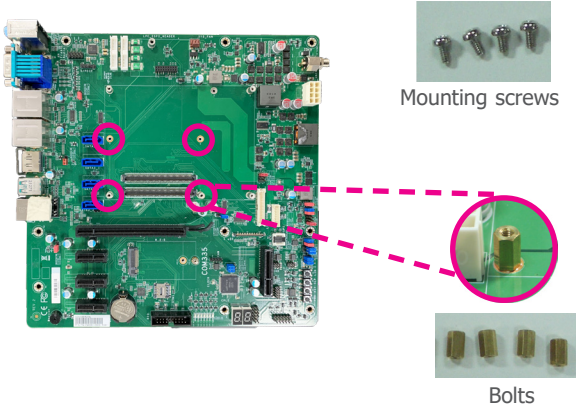

4. Use the provided bolts to fix the COMe-LINK2 debug card onto the carrier board.

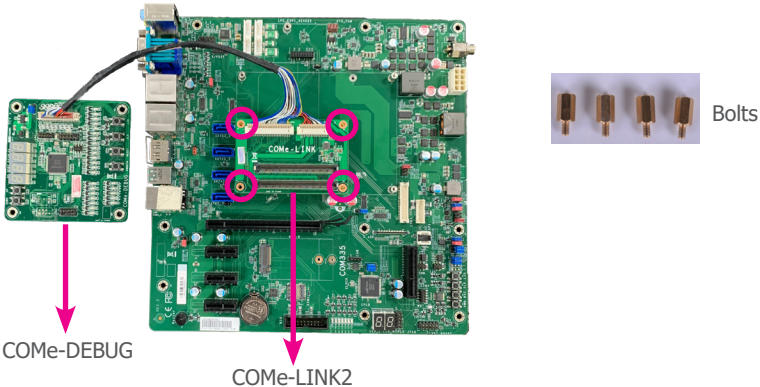
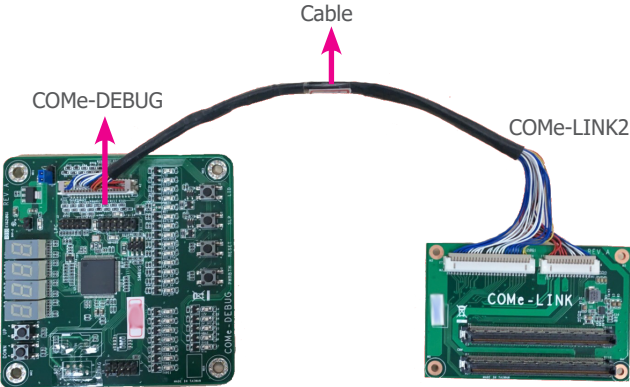

5. Grasp the COM Express Mini module by its edges to press it down on the top of the COMe-LINK2 debug card.

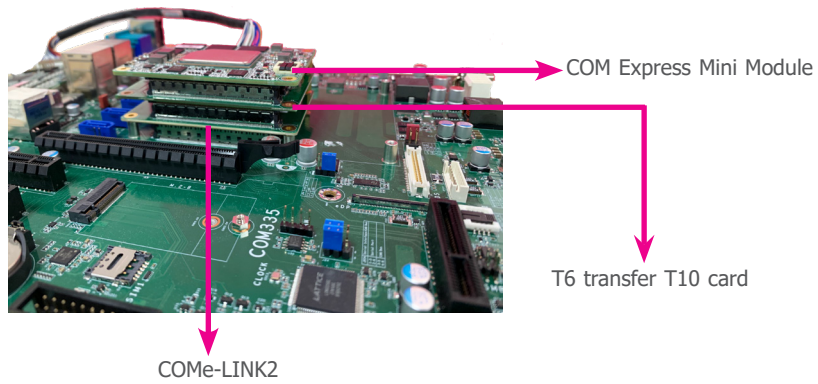

6. Then, grasp the heat sink by its edges and position it down firmly on the top of the COM Express Mini module.

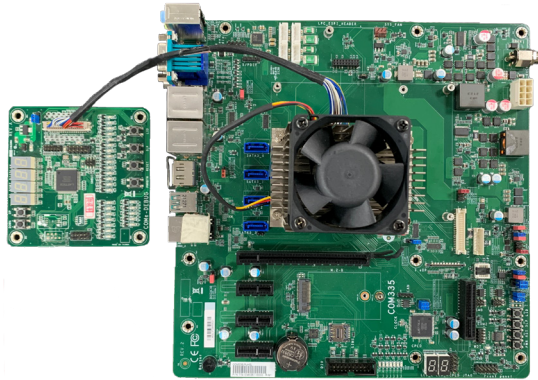

Chapter 4 - BIOS Setup

Overview

The BIOS is a program that takes care of the basic level of communication between the CPU and peripherals. It contains codes for various advanced features found in this system board. The BIOS allows you to configure the system and save the configuration in a battery-backed CMOS so that the data retains even when the power is off. In general, the information stored in the CMOS RAM of the EEPROM will stay unchanged unless a configuration change has been made such as a hard drive replaced or a device added.

It is possible that the CMOS battery will fail causing CMOS data loss. If this happens, you need to install a new CMOS battery and reconfigure the BIOS settings.



Note:

The BIOS is constantly updated to improve the performance of the system board; therefore the BIOS screens in this chapter may not appear the same as the actual one. These screens are for reference purpose only.

Default Configuration

Most of the configuration settings are either predefined according to the Load Optimal Defaults settings which are stored in the BIOS or are automatically detected and configured without requiring any actions. There are a few settings that you may need to change depending on your system configuration.

Entering the BIOS Setup Utility

The BIOS Setup Utility can only be operated from the keyboard and all commands are keyboard commands. The commands are available at the right side of each setup screen. The BIOS Setup Utility does not require an operating system to run. After you power up the system, the BIOS message appears on the screen and the memory count begins. After the memory test, the message “Press DEL to run setup” will appear on the screen. If the message disappears before you respond, restart the system or press the “Reset” button. You may also restart the system by pressing the <Ctrl> <Alt> and keys simultaneously.

Legends

KEYS	Function
Right and Left Arrows	Moves the highlight left or right to select a menu.
Up and Down Arrows	Moves the highlight up or down between submenus or fields.
<Esc>	Exits to the BIOS setup utility
+ (plus key)	Scrolls forward through the values or options of the highlighted field.
- (minus key)	Scrolls backward through the values or options of the highlighted field.
<F1>	Displays general help
<F2>	Displays previous values
<F9>	Optimized defaults
<F10>	Saves and reset the setup program.
<Enter>	Press <Enter> to enter the highlighted submenu

Scroll Bar

When a scroll bar appears to the right of the setup screen, it indicates that there are more available fields not shown on the screen. Use the up and down arrow keys to scroll through all the available fields.

Submenu

When “▶” appears on the left of a particular field, it indicates that a submenu which contains additional options are available for that field. To display the submenu, move the highlight to that field and press <Enter>.

► Main

The Main menu is the first screen that you will see when you enter the BIOS Setup Utility.

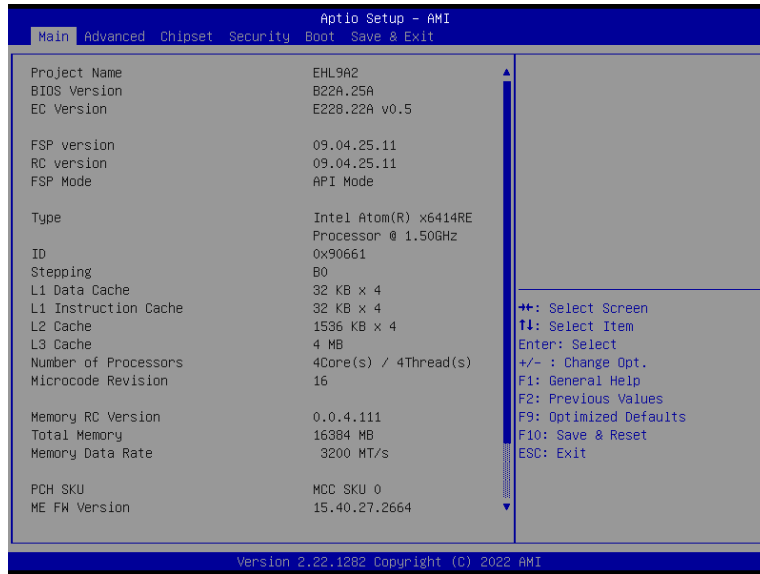

System Date

The date format is <month>, <date>, <year>. Press "Tab" to switch to the next field and press "-" or "+" to modify the value.

System Time

The time format is <hour>, <minute>, <second>. The time is based on the 24-hour military-time clock. For example, 1 p.m. is 13:00:00. Hour displays hours from 00 to 23. Minute displays minutes from 00 to 59. Second displays seconds from 00 to 59.

► Advanced

The Advanced menu allows you to configure your system for basic operation. Some entries are defaults required by the system board, while others, if enabled, will improve the performance of your system or let you set some features according to your preference.



Important:
Setting incorrect field values may cause the system to malfunction.

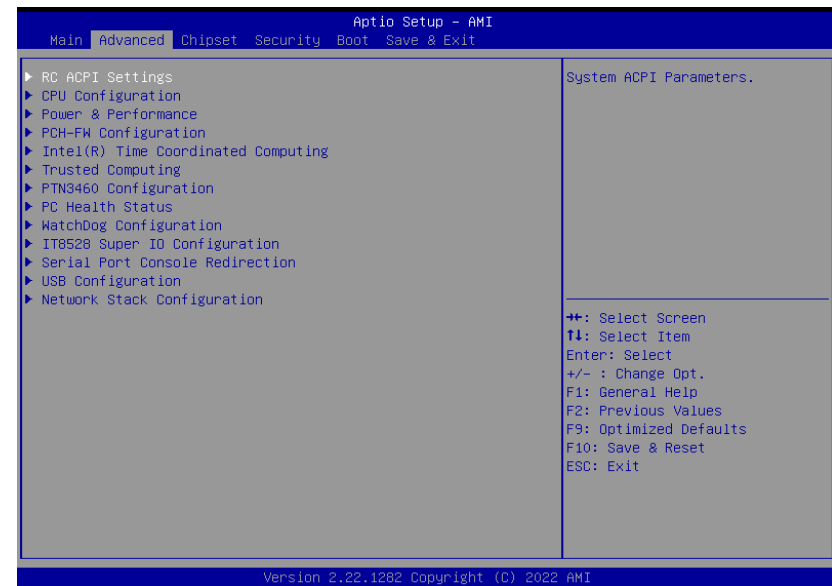

► Advanced

RC ACPI Configuration

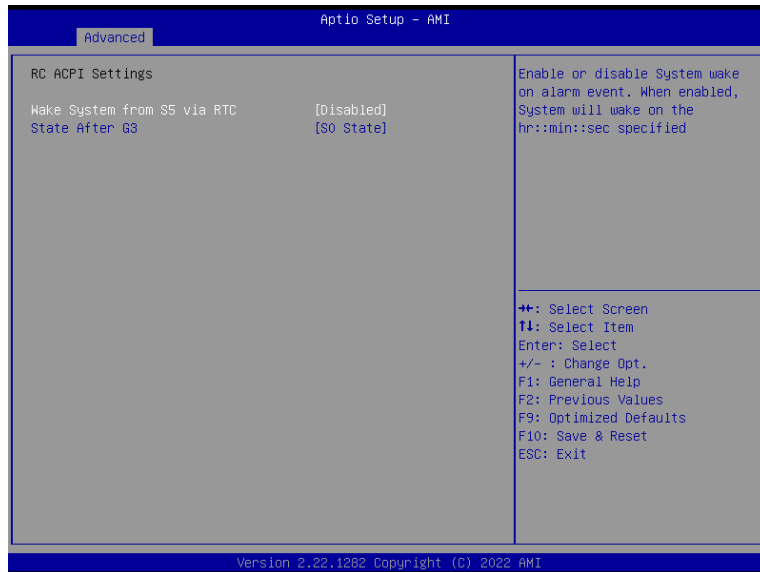

Wake system from S5 via RTC

When Enabled, the system will automatically power up at a designated time every day. Once it's switched to [Enabled], please set up the time of day — hour, minute, and second — for the system to wake up.

State After G3

Select between S0 State, and S5 State. This field is used to specify what state the system is set to return to when power is re-applied after a power failure (G3 state).

- **S0 State** The system automatically powers on after power failure.
- **S5 State** The system enter soft-off state after power failure. Power-on signal input is required to power up the system.
- **Last State** The system returns to the last state right before power failure.

► Advanced

CPU Configuration

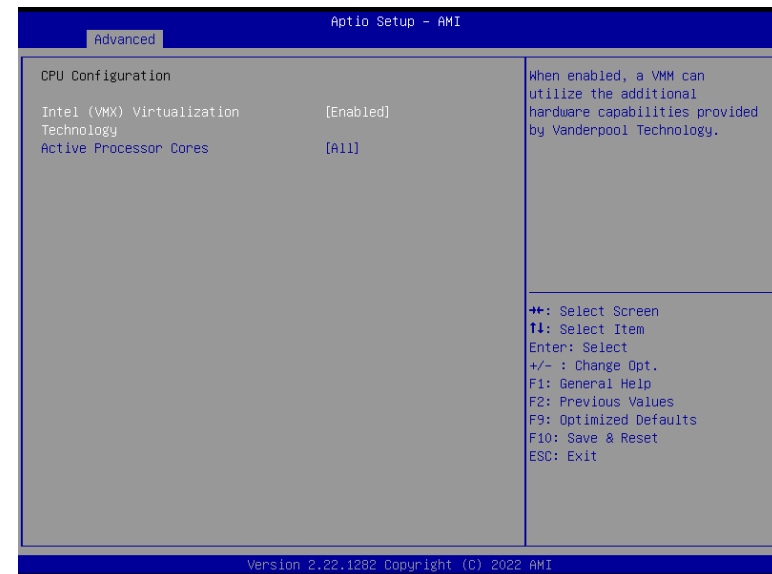

Intel (VMX) Virtualization Technology

When this field is set to Enabled, the VMM can utilize the additional hardware capabilities provided by Vanderpool Technology.

Active Processor Cores

Select number of cores to enable in each processor package.

▶ Advanced

Power & Performance

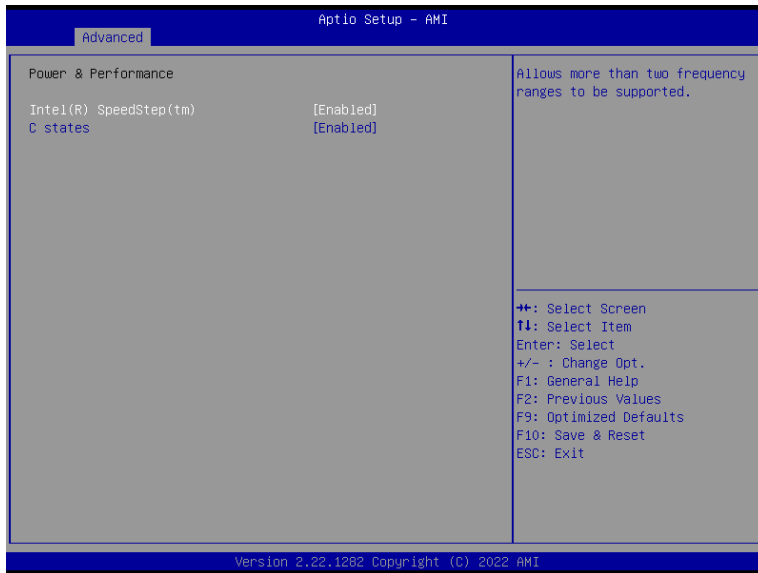

Intel(R) SpeedStep(tm)

This field is used to enable or disable the Intel SpeedStep® Technology, which helps optimize the balance between system's power consumption and performance. After it is enabled in the BIOS, EIST features can then be enabled via the operating system's power management.

C states

Enable or disable CPU Power Management. It allows CPU to enter "C states" when it's idle and nothing is executing.

▶ Advanced

PCH-FW Configuration

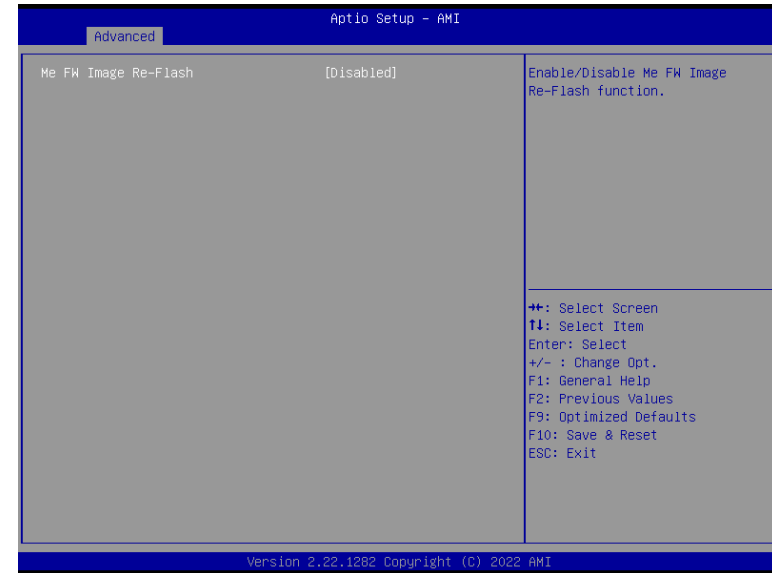

ME FW Image Re-Flash

Enable / Disable Me FW Image Re-Flash function.

► **Advanced**

Intel(R) Time Coordinated Computing



Software SRAM

Enable or Disable Software SRAM. Enable will allocate 1 way of LLC; if cache Configuration subregion is available, it will allocate based on the subregion.

Data Streams Optimizer

Enable or Disable Data Streams Optimizer (DSO). Enable will utilize DSO Subregion to tune system. DSO settings supercede Intel (R) TCC Mode settings that overlap between the two.

Error Log

Enable or Disable Error Log.
 Enable will record errors related to Intel (R) TCC and save them to memory.

Intel(R) TCC Authentication Menu

Intel(R) TCC Authentication Menu options.

Intel(R) TCC Mode

Enable or Disable Intel(R) TCC Mode. When enabled, this will modify system settings to improve real-time performance.
 The full list of settings and their current state are displayed below when Intel(R) TCC mode is enabled.

▶ Advanced

Trusted Computing

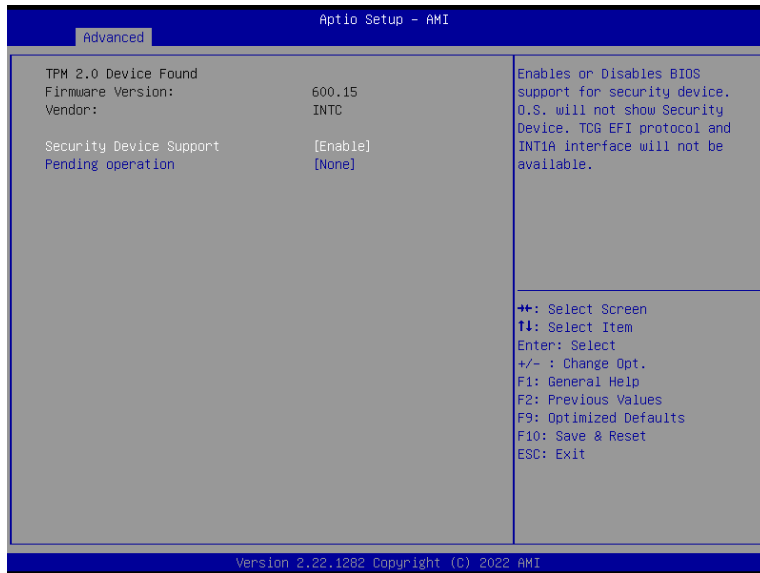

Security Device Support

This field is used to enable or disable BIOS support for the security device such as an TPM 2.0 to achieve hardware-level security via cryptographic keys.

Pending operation

To clear the existing TPM encryption, select "TPM Clear" and restart the system. This field is not available when "Security Device Support" is disabled.

▶ Advanced

PTN3460 Configuration

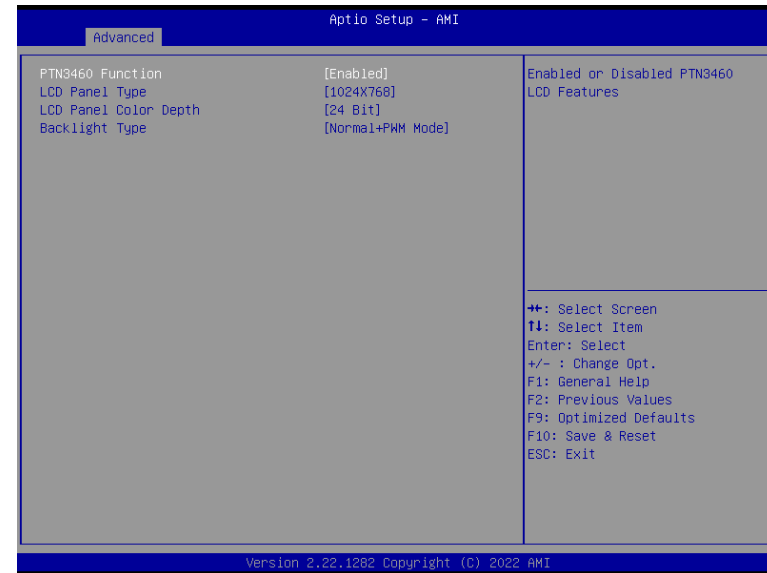

PTN3460 Function

Enabled or Disabled PTN3460 LCD Features.

LCD Panel Type

Select the resolution of the LCD Panel – 800X480, 800X600, 1024X768, 1366X768, 1024X600, 1280X800.

LCD Panel Color Depth

Select the color depth of the LCD Panel – 18 Bit, 24 Bit.

Backlight Type

Select the inverter polarity and brightness control – Normal+PWM Mode, Normal+DC Mode.

▶ **Advanced**

PC Health Status

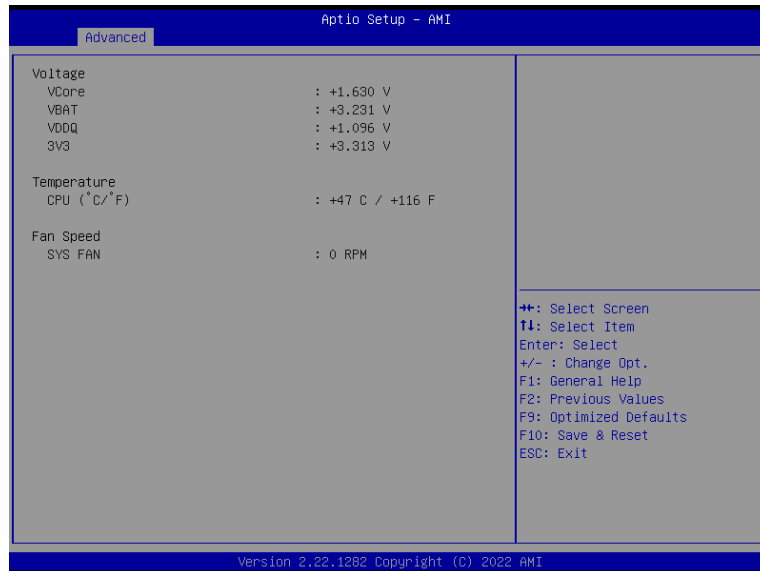

Lists voltage, temperature, and fan speed.

▶ **Advanced**

DFI WDT Configuration



Watchdog Timer
 Enable/Disable Watchdog Timer.

▶ Advanced

IT8528 Super IO Configuration

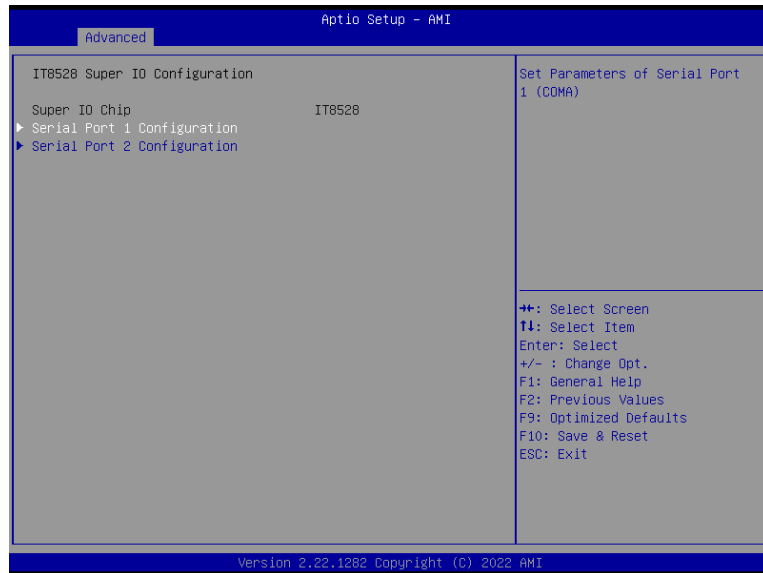

Serial Port Configuration

Set Parameters of Serial Ports. See next page.

▶ Advanced

IT8528 Super IO Configuration ▶ Serial Port 1, 2 Configuration



Serial Port

Enable or disable serial port.

► Advanced

Serial Port Console Redirection

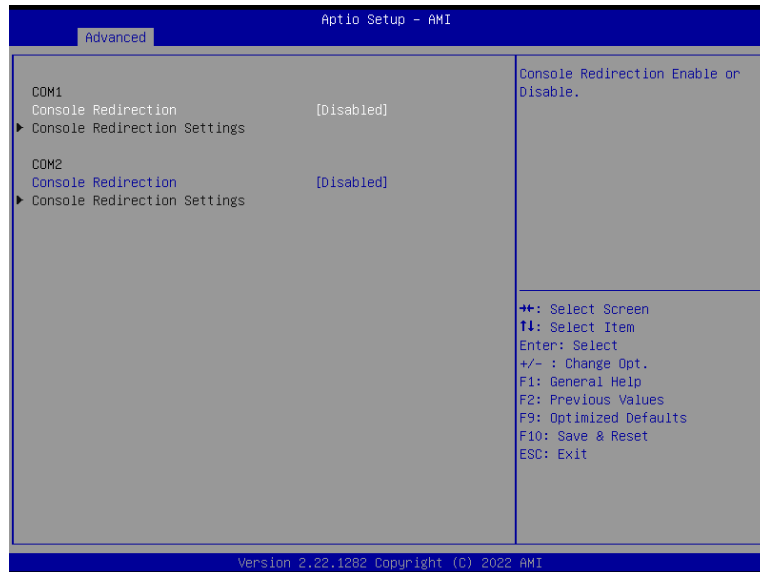

Console Redirection

Console Redirection Enable or Disable.

Console Redirection Settings

See following pages.

► Advanced

Serial Port Console Redirection ► Console Redirection Settings



Configure the serial settings of the current COM port.

Terminal Type

Select terminal type: VT100, VT100+, VT-UTF8 or ANSI.

Bits per second

Select serial port transmission speed: 9600, 19200, 38400, 57600 or 115200.

Data Bits

Select data bits: 7 bits or 8 bits.

Parity

Select parity bits: None, Even, Odd, Mark or Space.

Stop Bits

Select stop bits: 1 bit or 2 bits.

► Advanced

USB Configuration

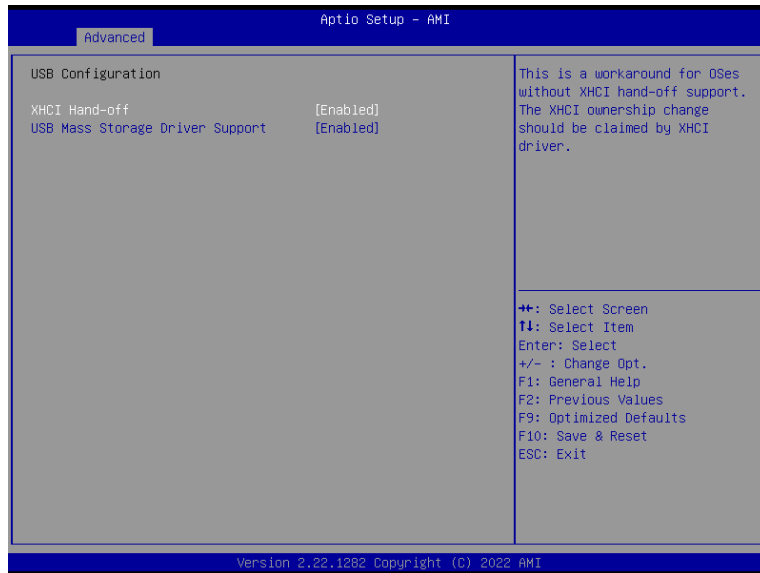

XHCI Hand-off

This is a workaround for OSes without XHCI hand-off support. The XHCI ownership change should be claimed by XHCI driver.

USB Mass Storage Driver Support

Enable or disable USB Mass Storage Driver Support.

► Advanced

Network Stack Configuration

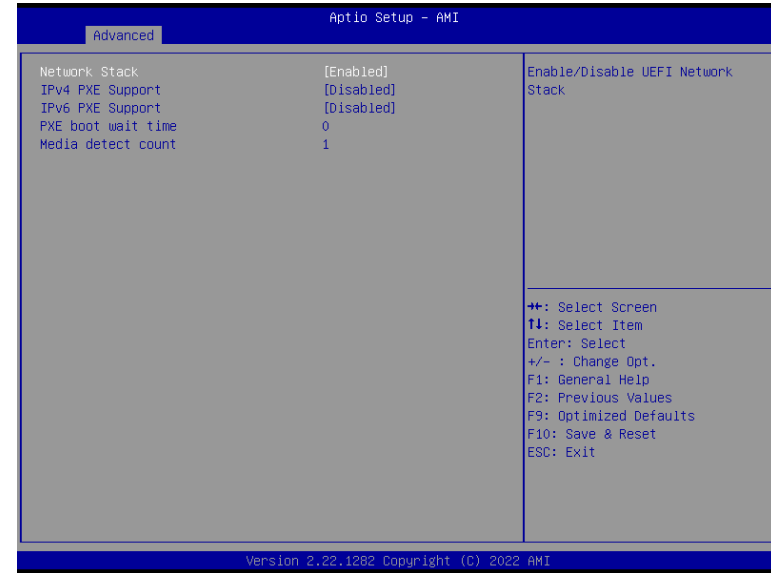

Network Stack

Enable or disable (Default) UEFI network stack. The following fields will appear when this field is enabled.

Ipv4 PXE Support Enable or disable IPv4 PXE boot support. If disabled, IPv4 PXE boot support will not be available.

Ipv6 PXE Support

Enable or disable IPv6 PXE boot support. If disabled, IPv6 PXE boot support will not be available.

PXE boot wait time

Set the wait time in seconds to press ESC key to abort the PXE boot. Use either +/- or numeric keys to set the value.

Media detect count

Set the number of times the presence of media will be checked. Use either +/- or numeric keys to set the value.

► **Chipset**

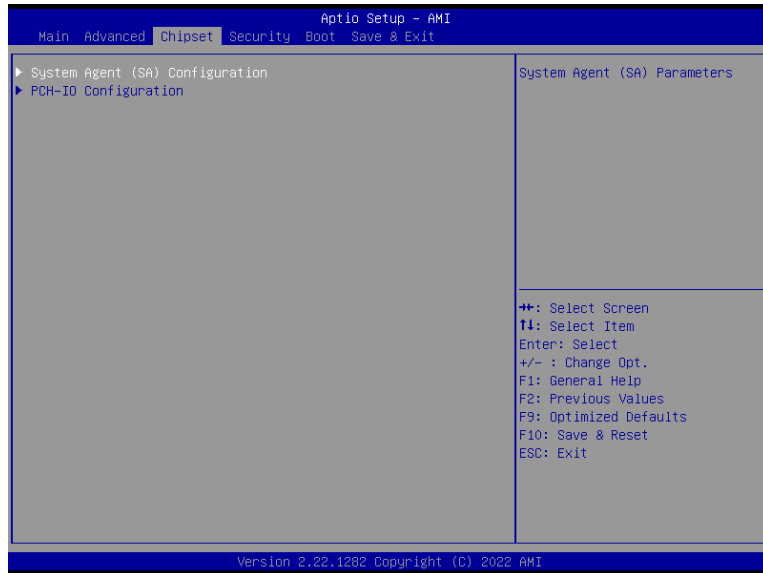

► **Chipset**

System Agent (SA) Configuration

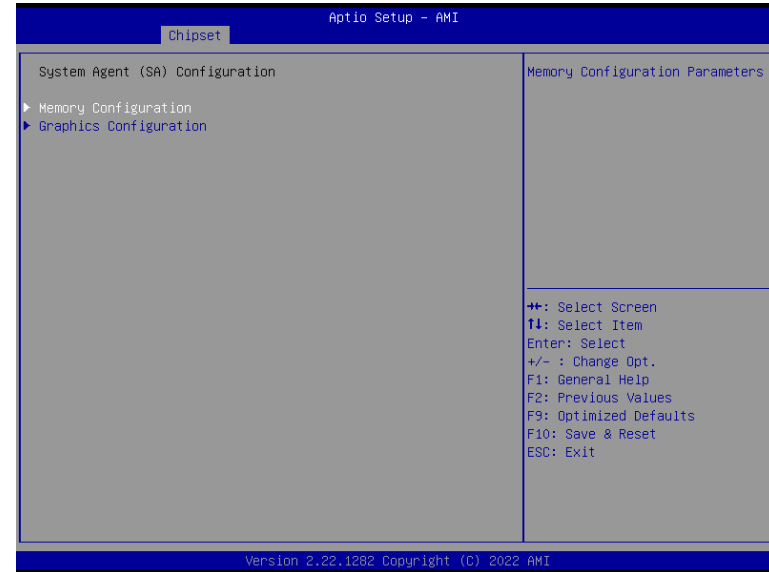

► Chipset

System Agent (SA) Configuration ► Memory Configuration

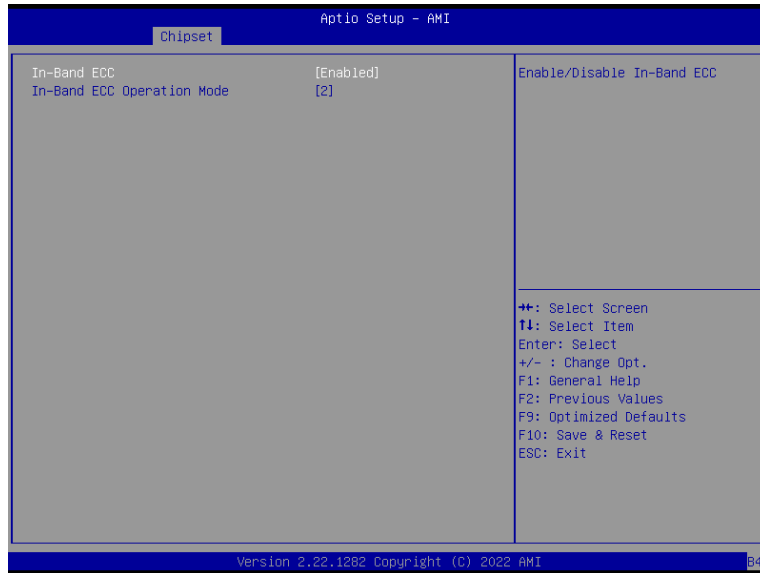

In-Band ECC

Enable/Disable (Default) In-Band ECC

In-Band ECC Operation Mode

- 0: Functional Mode protects requests based on the address range,
- 1: Makes all requests non protected and ignore range checks,
- 2: Makes all requests protected and ignore range checks

► Chipset

System Agent (SA) Configuration ► Graphics Configuration

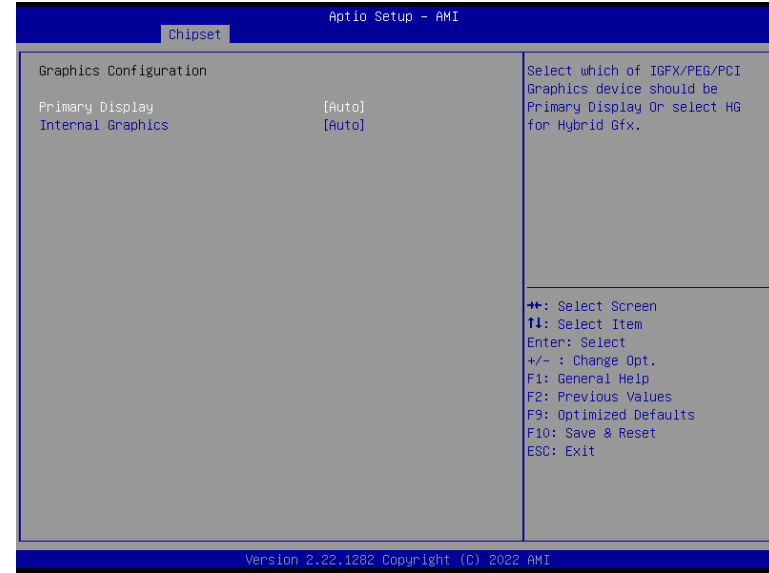

Primary Display

Select which of IGFX/PCI Graphics device to be the primary display.

Internal Graphics

Keep IGFX "Enabled" or "Disabled" based on the setup options, or select "Auto" for auto-detection.

► Chipset

PCH-IO Configuration



► Chipset

PCH-IO Configuration ► PCI Express Configuration

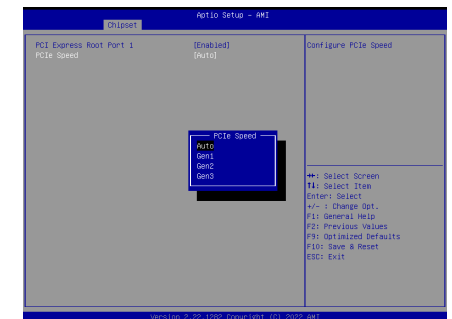
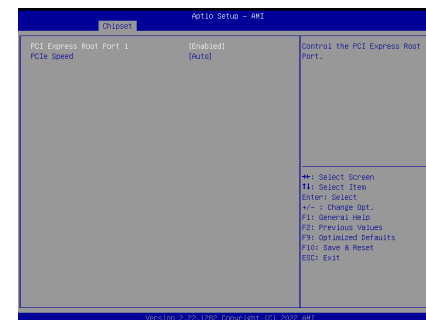
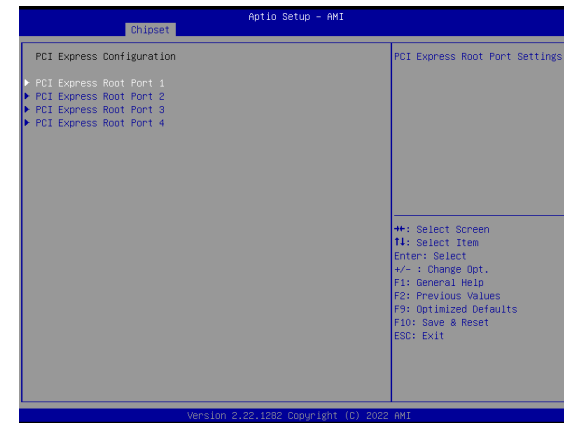

Select one of the PCI Express channels and press enter to configure the following settings.

PCIe Devices

Enable or disable the PCI Express Root Port. The following fields are only available when the PCIe root port is enabled.

PCI Express Root Port 1,2,3,4

Control the PCI Express Root Port.

PCIe Speed

Configure PCIe speed.

► Chipset

PCH-IO Configuration ► SATA Configuration

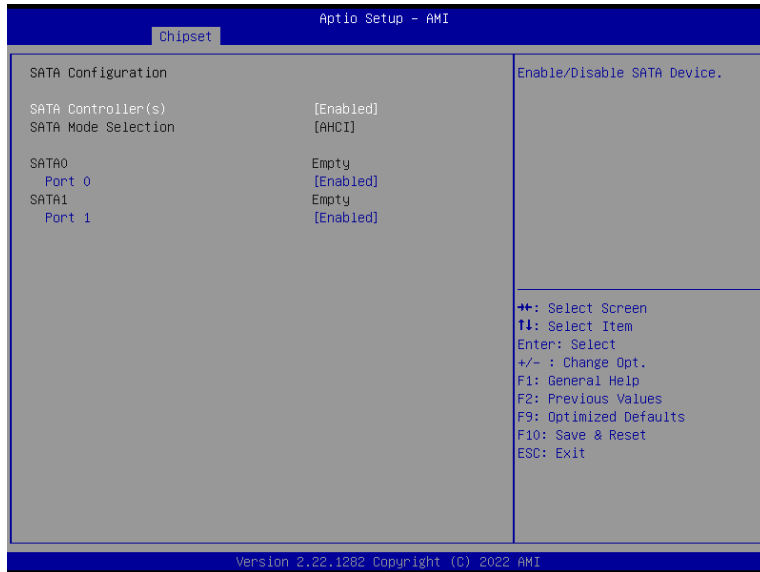

SATA Controller(s)

This field is used to enable or disable the Serial ATA controller.

SATA Mode Selection

The mode selection determines how the SATA controller(s) operates.

- **AHCI** This option allows the Serial ATA controller(s) to use AHCI (Advanced Host Controller Interface).

Ports

Enable or disable the Serial ATA ports.

► Chipset

PCH-IO Configuration ► Audio Configuration

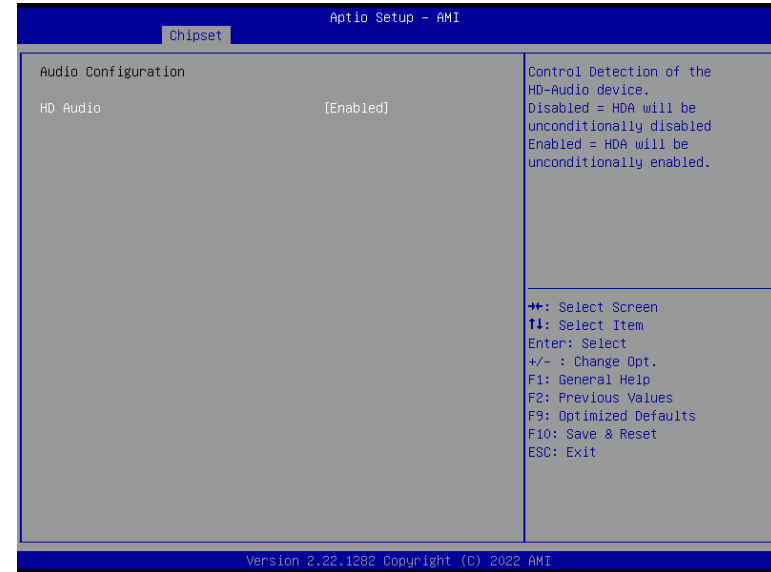

HD Audio

Control the detection of the HD Audio device.

- **Disabled** HDA will be unconditionally disabled.
- **Enabled** HDA will be unconditionally enabled.

► Security



Administrator Password

Set the administrator password. To clear the password, input nothing and press enter when a new password is asked. Administrator Password will be required when entering the BIOS.

► Security

Secure Boot



Secure Boot

Secure Boot feature is Active if secure Boot is Enabled, Platform Key (PK) is enrolled and the system is in user mode. The mode change requires platform reset.

Secure Boot Mode

Select the secure boot mode – Standard or Custom. When set to Custom, the following fields will be configurable for the user to manually modify the key database.

Restore Factory Keys

Force system to User Mode. Load OEM-defined factory defaults of keys and databases onto the Secure Boot. Press Enter and a prompt will show up for you to confirm.

Reset To Setup Mode

Clear the database from the NVRAM, including all the keys and signatures installed in the Key Management menu. Press Enter and a prompt will show up for you to confirm.

Key Management

Enables expert users to modify Secure Boot Policy variables without full authentication.

► Boot



Setup Prompt Timeout

Set the number of seconds to wait for the setup activation key. 65535 (0xFFFF) denotes indefinite waiting.

Bootup NumLock State

Select the keyboard NumLock state: On or Off.

Quiet Boot

This section is used to enable or disable quiet boot option.

Boot Option Priorities

Rearrange the system boot order of available boot devices.

► Save & Exit

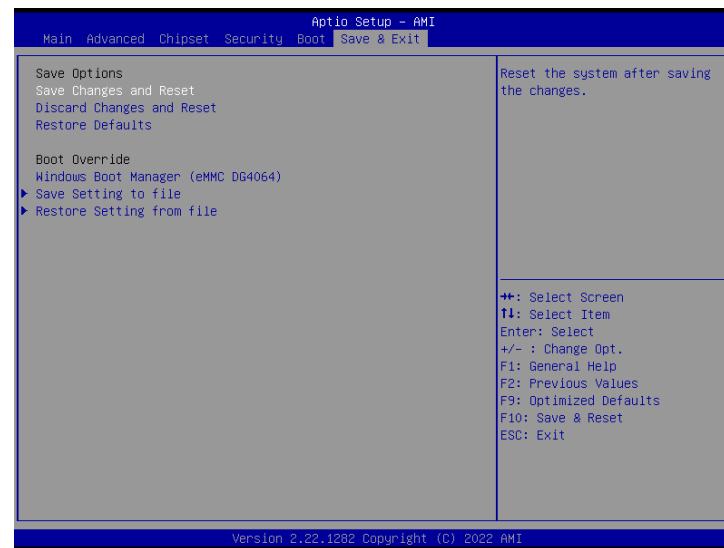

Save Changes and Reset

To save the changes, select this field and then press <Enter>. A dialog box will appear. Select Yes to reset the system after saving all changes made.

Discard Changes and Reset

To discard the changes, select this field and then press <Enter>. A dialog box will appear. Select Yes to reset the system setup without saving any changes.

Restore Defaults

To restore and load the optimized default values, select this field and then press <Enter>. A dialog box will appear. Select Yes to restore the default values of all the setup options.

Boot Override

Move the cursor to an available boot device and press Enter, and then the system will immediately boot from the selected boot device. The Boot Override function will only be effective for the current boot. The "Boot Option Priorities" configured in the Boot menu will not be changed.

► **Save Setting to file**

Select this option to save BIOS configuration settings to a USB flash device.

► **Restore Setting from file**

This field will appear only when a USB flash device is detected. Select this field to restore setting from the USB flash device.

► Updating the BIOS

To update the BIOS, you will need the new BIOS file and a flash utility. Please contact technical support or your sales representative for the files and specific instructions about how to update BIOS with the flash utility.

► Notice: BIOS SPI ROM

- 1. The Intel® Management Engine has already been integrated into this system board. Due to the safety concerns, the BIOS (SPI ROM) chip cannot be removed from this system board and used on another system board of the same model.
- 2. The BIOS (SPI ROM) on this system board must be the original equipment from the factory and cannot be used to replace one which has been utilized on other system boards.
- 3. If you do not follow the methods above, the Intel® Management Engine will not be updated and will cease to be effective.

**Note:**

- a. You can take advantage of flash tools to update the default configuration of the BIOS (SPI ROM) to the latest version anytime.
- b. When the BIOS IC needs to be replaced, you have to populate it properly onto the system board after the EEPROM programmer has been burned and follow the technical person's instructions to confirm that the MAC address should be burned or not.
- c. After updating unique MAC Address from manufacturing, NVM will be protected immediately after power cycle. Users cannot update NVM or MAC address.