



# **RC300-CS**

## **Railway Fan-less Box PC**

### **User's Manual**

**Preliminary**

## Copyright

This publication contains information that is protected by copyright. No part of it may be reproduced in any form or by any means or used to make any transformation/adaptation without the prior written permission from the copyright holders.

This publication is provided for informational purposes only. The manufacturer makes no representations or warranties with respect to the contents or use of this manual and specifically disclaims any express or implied warranties of merchantability or fitness for any particular purpose. The user will assume the entire risk of the use or the results of the use of this document. Further, the manufacturer reserves the right to revise this publication and make changes to its contents at any time, without obligation to notify any person or entity of such revisions or changes.

Changes after the publication's first release will be based on the product's revision. The website will always provide the most updated information.

© 2021. All Rights Reserved.

## Trademarks

Product names or trademarks appearing in this manual are for identification purpose only and are the properties of the respective owners.

## FCC and DOC Statement on Class A

This equipment has been tested and found to comply with the limits for a Class A digital device, pursuant to Part 15 of the FCC rules. These limits are designed to provide reasonable protection against harmful interference when the equipment is operated in a residential installation. This equipment generates, uses and can radiate radio frequency energy and, if not installed and used in accordance with the instruction manual, may cause harmful interference to radio communications. However, there is no guarantee that interference will not occur in a particular installation. If this equipment does cause harmful interference to radio or television reception, which can be determined by turning the equipment off and on, the user is encouraged to try to correct the interference by one or more of the following measures:

- Reorient or relocate the receiving antenna.
- Increase the separation between the equipment and the receiver.
- Connect the equipment into an outlet on a circuit different from that to which the receiver is connected.
- Consult the dealer or an experienced radio TV technician for help.

### Notice:

1. The changes or modifications not expressly approved by the party responsible for compliance could void the user's authority to operate the equipment.
2. Shielded interface cables must be used in order to comply with the emission limits.

# Table of Contents

Copyright.....	2
Trademarks.....	2
FCC and DOC Statement on Class A.....	2
About this Manual.....	4
Warranty.....	4
Static Electricity Precautions.....	4
Safety Measures.....	4
Safety Precautions.....	5
About the Package.....	5
Before Using the System.....	5
Chapter 1 - Introduction.....	6
Specifications.....	6
Getting to Know the RC300-CS.....	8
Mechanical Dimensions.....	9
Chapter 2 - Getting Started.....	10
Chapter 3 - Installing Devices.....	11
Preface.....	11
Devide the power parts.....	11
Pin Define of M12 PoE.....	14
x1 / x2 slots for CANbus or MVB connectors.....	15
Pin Define of DI/DO.....	16
Pin Define of COM1/2.....	17
Pin Define of DC110V.....	19
Board Layout.....	20
Jumper Settings.....	21
Internal Connectors.....	27
Chapter 4 - BIOS Setup.....	36
Overview.....	36
Aptio BIOS Setup Utility.....	37
Main.....	37
Advanced.....	37
Chipset.....	49
Security.....	53
UPS.....	54
Boot.....	55
Save & Exit.....	55
Updating the BIOS.....	56
Notice: BIOS SPI ROM.....	56

## About this Manual

An electronic file of this manual can be obtained from the DFI website at [www.dfi.com](http://www.dfi.com). To download the user's manual from our website, please go to Support > Download Center. On the Download Center page, select your product or type the model name and click "Search" to find all technical documents including the user's manual for a specific product.

## Warranty

1. Warranty does not cover damages or failures that arised from misuse of the product, inability to use the product, unauthorized replacement or alteration of components and product specifications.
2. The warranty is void if the product has been subjected to physical abuse, improper installation, modification, accidents or unauthorized repair of the product.
3. Unless otherwise instructed in this user's manual, the user may not, under any circumstances, attempt to perform service, adjustments or repairs on the product, whether in or out of warranty. It must be returned to the purchase point, factory or authorized service agency for all such work.
4. We will not be liable for any indirect, special, incidental or consequential damages to the product that has been modified or altered.

## Static Electricity Precautions

It is quite easy to inadvertently damage your PC, system board, components or devices even before installing them in your system unit. Static electrical discharge can damage computer components without causing any signs of physical damage. You must take extra care in handling them to ensure against electrostatic build-up.

1. To prevent electrostatic build-up, leave the system board in its anti-static bag until you are ready to install it.
2. Wear an antistatic wrist strap.
3. Do all preparation work on a static-free surface.
4. Hold the device only by its edges. Be careful not to touch any of the components, contacts or connections.
5. Avoid touching the pins or contacts on all modules and connectors. Hold modules or connectors by their ends.



### Important:

Electrostatic discharge (ESD) can damage your processor, disk drive and other components. Perform the upgrade instruction procedures described at an ESD workstation only. If such a station is not available, you can provide some ESD protection by wearing an antistatic wrist strap and attaching it to a metal part of the system chassis. If a wrist strap is unavailable, establish and maintain contact with the system chassis throughout any procedures requiring ESD protection.

## Safety Measures

To avoid damage to the system:

- Use the correct AC input voltage range.

To reduce the risk of electric shock:

- Unplug the power cord before removing the system chassis cover for installation or servicing. After installation or servicing, cover the system chassis before plugging the power cord.

Battery:

- Danger of explosion if battery incorrectly replaced.
- Replace only with the same or equivalent type recommend by the manufacturer.
- Dispose of used batteries according to local ordinance.

## Safety Precautions

- Use the correct DC input voltage range.
- Unplug the power cord before removing the system chassis cover for installation or servicing. After installation or servicing, cover the system chassis before plugging the power cord.
- Danger of explosion if battery incorrectly replaced.
- Replace only with the same or equivalent type recommend by the manufacturer.
- Dispose of used batteries according to local ordinance.
- Keep this system away from humidity.
- Place the system on a stable surface. Dropping it or letting it fall may cause damage.
- The openings on the system are for air ventilation to protect the system from overheating. **DO NOT COVER THE OPENINGS.**
- Place the power cord in such a way that it will not be stepped on. Do not place anything on top of the power cord. Use a power cord that has been approved for use with the system and that it matches the voltage and current marked on the system's electrical range label.
- If the system will not be used for a long time, disconnect it from the power source to avoid damage by transient overvoltage.
- If one of the following occurs, consult a service personnel:
  - The power cord or plug is damaged.
  - Liquid has penetrated the system.
  - The system has been exposed to moisture.
  - The system is not working properly.
  - The system dropped or is damaged.
  - The system has obvious signs of breakage.
- The unit uses a three-wire ground cable which is equipped with a third pin to ground the unit and prevent electric shock. Do not defeat the purpose of this pin. If your outlet does not support this kind of plug, contact your electrician to replace the outlet.
- Disconnect the system from the DC outlet before cleaning. Use a damp cloth. Do not use liquid or spray detergents for cleaning.

## About the Package

The package contains the following items. If any of these items are missing or damaged, please contact your dealer or sales representative for assistance.

- 1 RC300-CS system unit
- 1 Counter Part Power connector
- 1 Wall-mount bracket

## Optional Items

Optional Items	Part Number	Description
2.5" SSD	785-S251TBG 785-S25512G 785-S25256G 785-S25128G"	"2.5"" SATA SSD, 1TB MLC, -40 to 85°C, RoHS 2.5"" SATA SSD, 512GB MLC, -40 to 85°C, RoHS 2.5"" SATA SSD, 256GB MLC, -40 to 85°C, RoHS 2.5"" SATA SSD, 128GB MLC, -40 to 85°C, RoH"
M.2 SATA SSD	785-M2SATA64G	64GB, M.2 2280 SSD, SATA3 B+M Key, MLC, Wide Temp.
M.2 SATA SSD	785-M2SATA128G	128GB, M.2 2280 SSD, SATA3 B+M Key, MLC, Wide Temp.
M.2 SATA SSD	785-M2SATA256G	256GB, M.2 2280 SSD, SATA3 B+M Key, MLC, Wide Temp.
M.2 SATA SSD	785-M2SATA512G	512GB, M.2 2280 SSD, SATA3 B+M Key, 3D TLC, PE: 3K, 30u" -20~75
Memory	138-580004-104G	8GB DDR4 2666Mhz SO-DIMM 1Rx8 IND 1Gx8 CL19 1.2V
Memory	138-540002-121G	4GB DDR4 2666Mhz SO-DIMM, '-40 to 85C
WiFi/BT module kit	761-AP1235-000G	WiFi/Bluetooth Module AP12356, antenna *2, 200mm SMA cables*2, Mini PCIe Bracket, screws
LTE module kit	761-RC3000-001G	Quectel EG25GGB CAT4 miniPCIe module, antenna*2, 300mm SMA cables*2
5G module kit	761-RC3000-100G	SIM8202G-M2 M.2 module, antenna*4, 184mm SMA cables *4
M12 Cable	A81-005038-054G	8-pin M12 X-coded to RJ45 PoE cable
CAN bus module	770-MPE21-100G	MPE-CAN2 MiniPCIe Full CAN Module Card Assembly

# Chapter 1 - Introduction

## Specifications

<b>SYSTEM</b>	Processor	8th/9th Generation Intel® Core™ Processors, LGA 1151 Intel® Core™ i7-9700TE Processor, 8C/8T, 12MB Cache, 1.8GHz, TDP 35W Intel® Core™ i7-8700T Processor, 6C/12T, 12MB Cache, 2.4GHz, TDP 35W Intel® Core™ i5-9500TE Processor, 6C/6T, 9MB Cache, 2.2GHz, TDP 35W (Other CPU support upon request)
	Chipset	Intel® Q370 Chipset
	Memory	Dual Channel DDR4 2666/2400 MHz by SODIMMs up to 64GB
	BIOS	AMI SPI 128Mbit
<b>GRAPHICS</b>	Controller	Intel® HD Graphics
	Display	1 x VGA (display out by DB15 connector) 1 x HDMI (with screw lock) 1 x DP++ (Standard Display Port Connector DIP type with screw lock) Support NVIDIA Optimus technology VGA: resolution up to 1920x1200 @ 60Hz HDMI: resolution up to 4096x2160 @ 24Hz DP++: resolution up to 4096x2304 @ 60Hz
	GPU	Support MXM 3.1 Type A/B/C: P2000, T1000, RTX2060, RTX2070, RTX3000 GPU modules  Maximum package power 120W, inrush current 150W PCIe x16
<b>STORAGE</b>	External	4 x Swappable 2.5" 7mm SSD storage bays (RC300H-CS)  2x Swappable 2.5" 7mm SSD storage bays with lock (RC300L-CS, RC300H-CS-UPS)
	Interface	1 x Half-size Mini PCIe for WiFi/BT modules, with PCIe x1 & USB signal 2 x Full-size Mini PCIe support PCIe x1 & USB 2.0 signal with SIM of each  1 x M.2 B key supports 3042, 3052 devices or 5G module on PCIe x1, USB2.0, USB3.0 signal with SIM slot (SIM card can be external accessible with cover)  1 x M.2 2280 M key supports 2242, 2260 & 2280 devices (PCIe x4 & SATA signal, support boot up function)  All SIM cards can be accessed from external with cover protection not only for M.2 but also mPCIe slots.
<b>AUDIO</b>	Audio Codec	Realtek ALC262
<b>ETHERNET</b>	Controller	5 x Intel® I210IT NIC (10/100/1000Mbps)  1 x Intel® I219LM with iAMT11.0 PCIe (10/100/1000Mbps)  (only Core i7/i5 supports iAMT)
	Interface	2 x RJ45 GbE  4 x M12 X-coded 802.3af 15.4W PoE ports
<b>LED</b>	Indicators	1 x Power LED (Green)  5 x Storage LED (Red)  4 x PoE LED

<b>Front I/O</b>	PoE	4 x M12 X-coded 802.3af PoE  Support 802.11af, max 15.4W (PSE side)  NOT support wake on Lan
	Ethernet	2 x GbE (RJ-45) support Wake on Lan
	Serial	2 x BIOS selection RS-232/422/485 by 2x DB-9
	USB	4 x USB 3.0 (type A)
	Display	1 x VGA display out by DB15 connector
	DIO	1 x 8bit isolated DI port by DB-9 connector  1 x 8bit isolated DO port by DB-9 connector  2KV isolation
	Power-in	RC300H-CS : 1 x 6pin 5.0mm terminal block RC300L-CS : 1 x 9pin 5.0mm terminal block
	<b>Rear I/O</b>	USB
Display		1 x HDMI  1 x DP++
Audio		1 x Mic-in  1 x Line-out  by 3.5mm 3P Phone Jack
Buttons		1 x Power Button  1 x Reset Button
	SIM	3 x SIM sockets (external accessible with cover)
<b>Watchdog Timer</b>	Output & Interval	System Reset, Programmable via Software from 1 to 255 Seconds
<b>Security</b>	TPM	TPM 2.0
<b>Power</b>	Type	RC300H-CS: 110VDC nominal power input (77VDC~137.5VDC power range) RC300L-CS: 12/24VDC nominal power input (9VDC~36VDC power range)
	Connector	RC300H-CS : 1 x 6pin 5.0mm terminal block RC300L-CS : 1 x 9pin 5.0mm terminal block
	Battery (UPS)	Optional UPS battery kit for at least 5min operations at full loading max. 300W (will occupy two SSDs space), RC300H-CS only (RC300H-CS-UPS)
<b>Power Consumption</b>	Boot up	78.4W
	Idle	36.1W
	Max App Load	209W
	Worse Case Load	232W
	3DMark Load	168W
	S3	8W
	S5	7.6W

<b>Power Consumption is based on</b>		
<b>MXM module NVIDIA GeForce RTX 2070 8GB GDDR6(RTX2070MSD6, AETINA)</b>		
<b>OS Support</b>	OS Support	Windows 10 IoT Enterprise 64 Bit Ubuntu 18.04
<b>Environment</b>	Temperature	-25°C to 70°C with when CPU+GPU<100W, up to +85°C for 10min -25°C to 55°C with when CPU+GPU<160W, up to +70°C for 10min Turboboost is disabled and CPU&GPU will be throttling at high temperature.
	Storage Temperature	-40 to 85°C
	Relative Humidity	10% to 90% (non-condensing)
<b>Mechanism</b>	Dimensions	340.5(W) x 223(D) x 132(H) mm (3U height, excluding rubber foot)
	Construction	Metal + Aluminum
	Mounting	Wall mount
	Weight	9.85 kg
<b>Standards and Certifications</b>	Shock	EN61373: 2010, Category 1 Class A & Class B
	Vibration	EN61373: 2010, Category 1 Class B
	Certifications	CE, FCC Class B (Tested with Adapter)
		EMC: EN50121-3-2
		Safety: EN50153, EN50124-1
Fire Proof: EN45545		
	Railway Regulation: EN50155 (Class S1: for RC300H-CS)	
	IP Rating	IP40
<b>Country of Origin</b>	Country of Origin	Taiwan

## Getting to Know the RC300-CS

### Front View

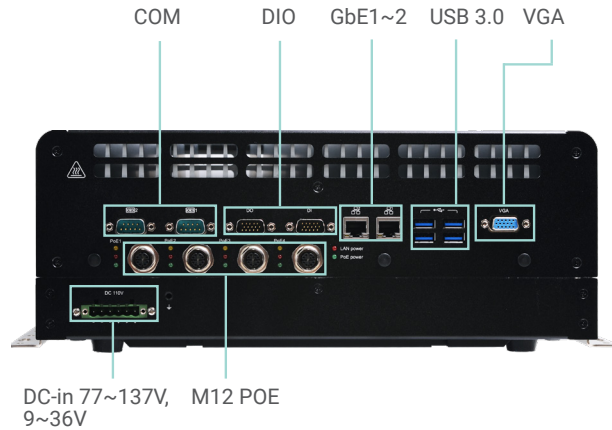

#### DC-in Jack

Connects a DC-in power adapter. Please note the acceptable power range: 77-137V, 9~36V.

#### USB Ports (3.0)

Connect USB 3.0/2.0/1.1 devices. They comply with USB 3.0 which supports data transmission rate up to 5 Gbits.

#### LAN Ports

Connect the system to a local area network.

#### VGA Port

Connects to the VGA port of an LCD monitor.

#### DIO

Supports 8-bit digital output and input.

#### COM

Used to connect serial devices.

#### M12 PoE

Connect to PoE receivers.

### Rear View

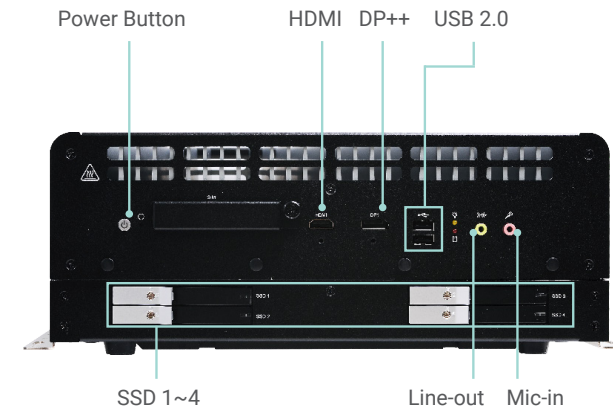

#### Power Button

Press to power-on or power-off the system.

#### USB Ports (2.0)

Connect USB 2.0/1.1 devices.

#### Line-out

Connect the audio output devices.

#### Mic-in

Connect the microphone or audio input devices.

#### HDMI Port

Connects to the HDMI port of an LCD monitor.

#### DisplayPort

Connects to the DisplayPort of an LCD monitor.

#### SSD

2.5" slots for SSD hard disks.



## Mechanical Dimensions

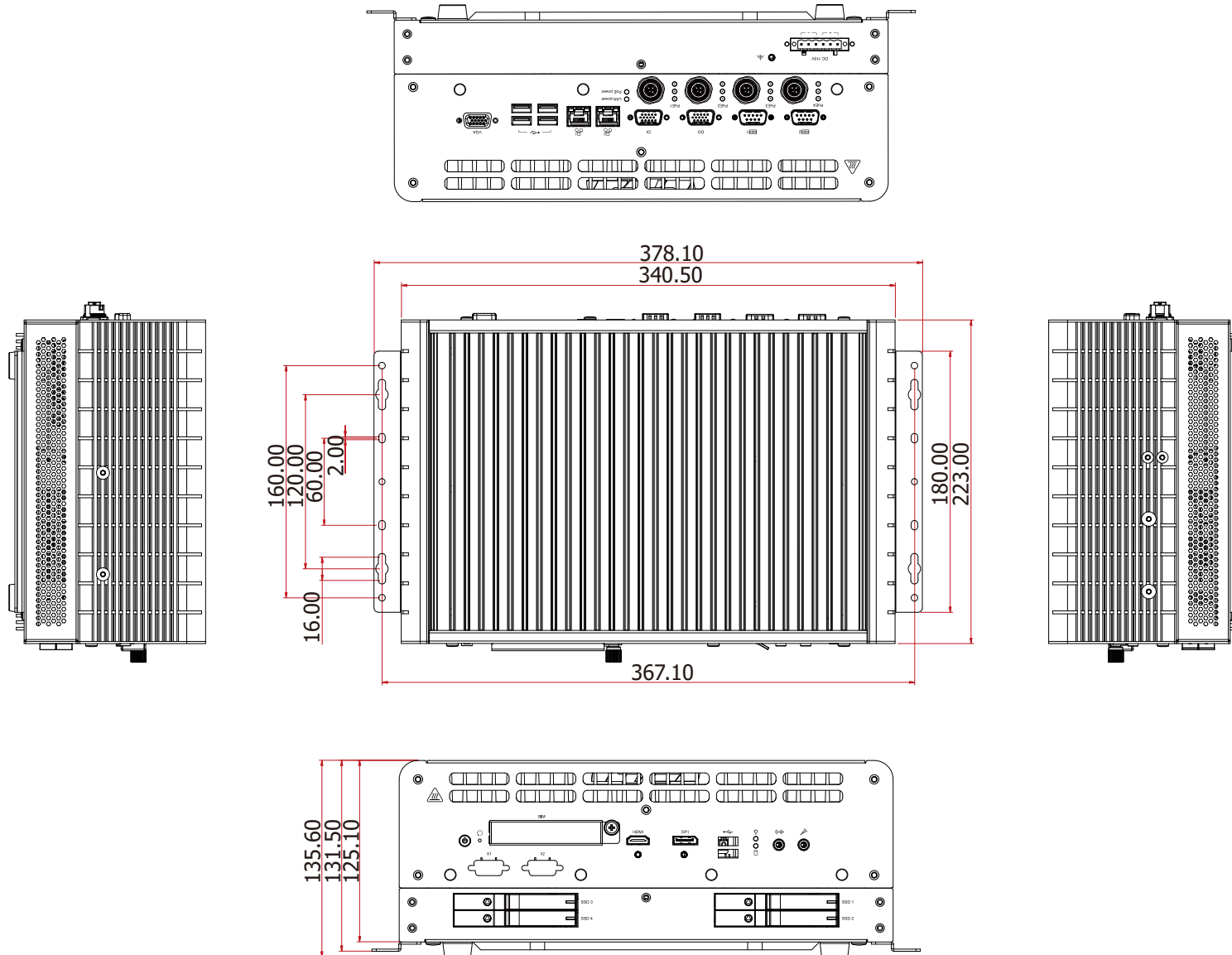

## Chapter 2 - Getting Started

### Preparing the System

Before you start using the system, you need the following items:

- SATA hard drive
- DC Power connector
- Screwdriver
- Memory modules

### Installing Devices

The following devices can be installed in the system.

- All the optional items.
- SATA HDD is not supported.

### Configuring the BIOS

To get you started, you may need to change configurations such as the date, time and the type of hard disk drive.

1. Power on the system.
2. After the memory test, the message "Press DEL to run setup" will appear on the screen. Press the Delete key to enter the BIOS setup utility.

### Installing the Operating System

Make sure that a SATA drive is already installed.

1. Refer to the following chapters for information on installing a SATA drive
2. Refer to your operating system manual for instructions on installing an operating system.

### Compatible MXM Modules

Type	Model	CUDA cores	Power	Support operating temperature
Quadro	P1000	512	47W	-20°C to +70°C
Quadro	P2000	768	58W	-20°C to +70°C
Quadro	T1000	896	50W	-20°C to +70°C
Quadro	RTX3000	1920	80W	-20°C to +55°C
Quadro	RTX5000	3072	150W	-20°C to +55°C (external air flow needed)

## Chapter 3 - Installing Devices



### Import:

To prevent damage to the system board, power down the system and remove all power cords before opening the chassis cover.

### Preface

RC300-CS is combined by two parts: Power part and main body. By deviding the power parts you can install so-dimm / m.2 / mini-PCIe modules.

#### Main Body ↓



#### Power Part ↑

### Devide the power parts

1. Turn over the machine to let the bottom side become the top.



2. Remove two screws circled by red in each corner.

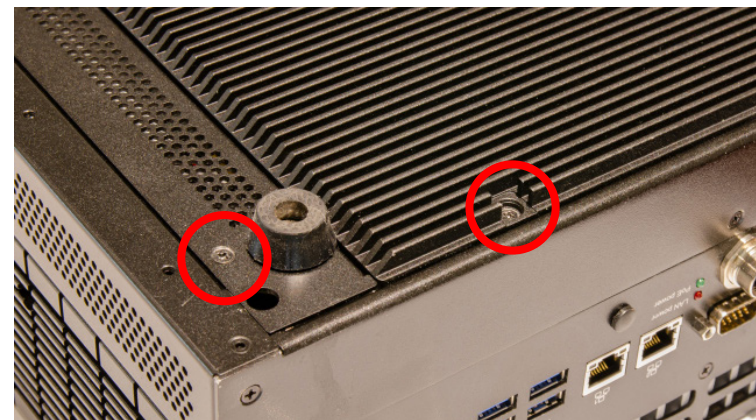

3. Remove the bottom case



5. There're two 2.5" hdd slots for harddisk/SSD installation.



4. The power part appears.



5. If you want to change/remove/install other components, please remove the power part first. Remove the 4 screws in each corner circled by red.

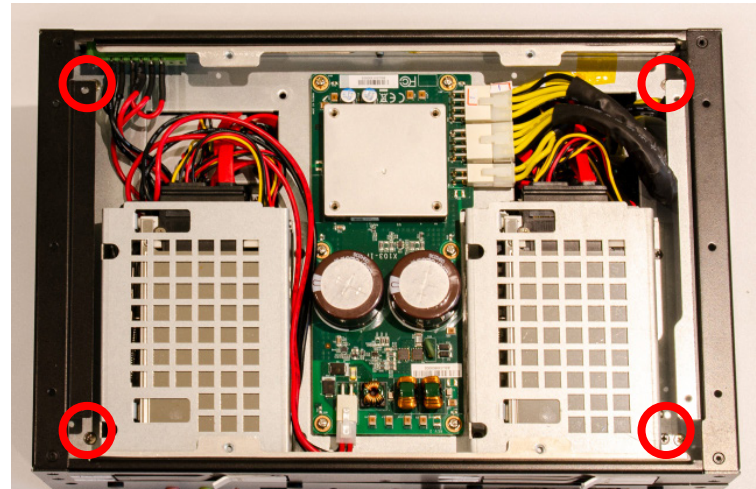

6. Tilt up to remove the power part carefully and slowly. Please unplug these cables first.

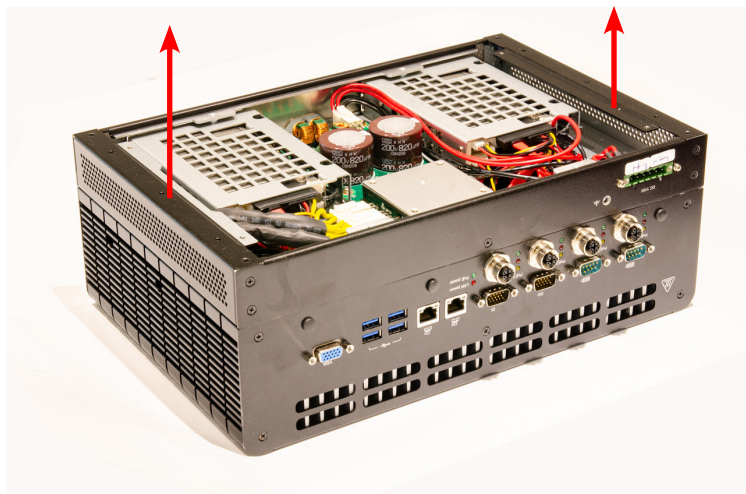

7. The main body appears.

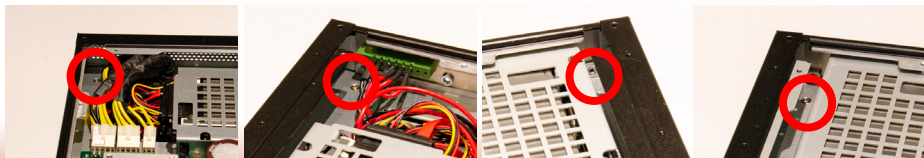

8. Remove each component by the screws circled in red.

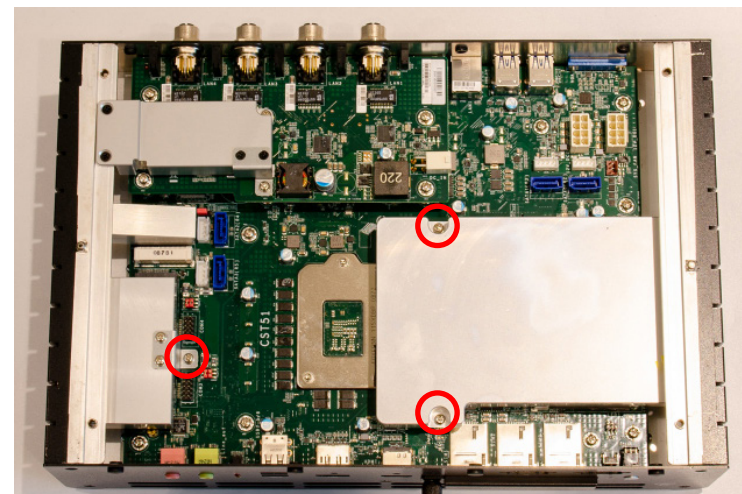

9. The expansion slots appear.

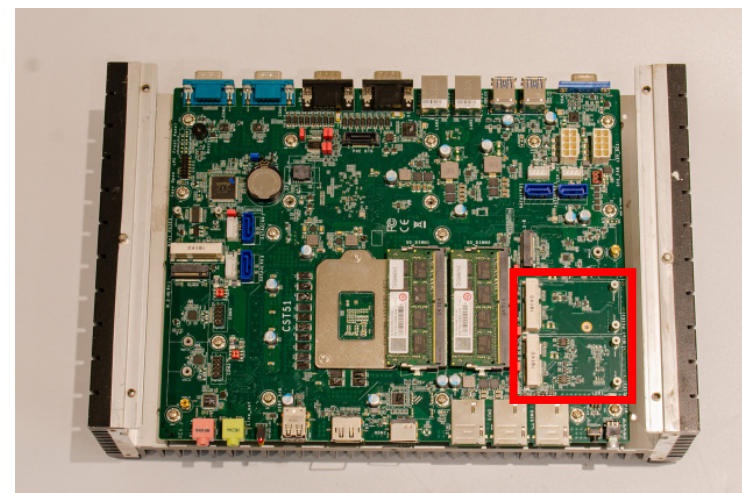

## Pin Define of M12 PoE

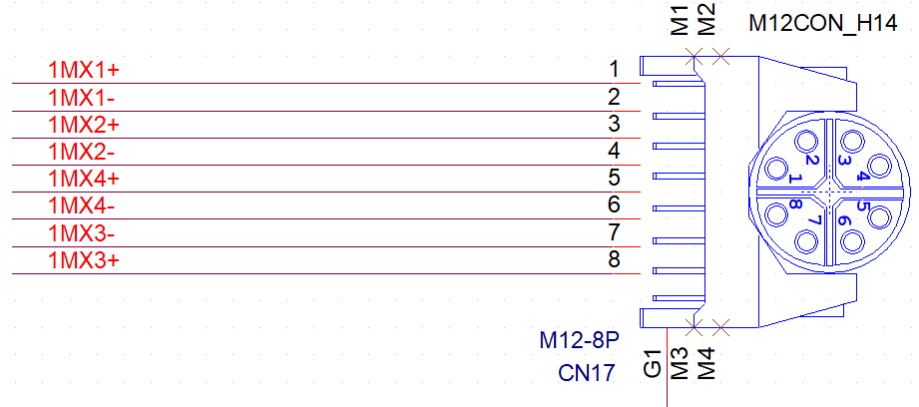
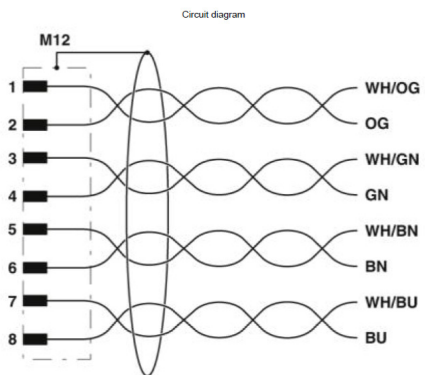
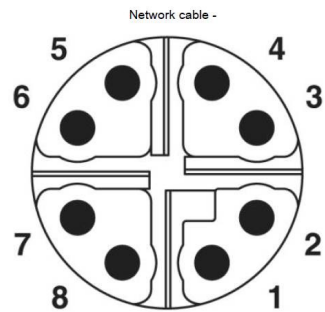
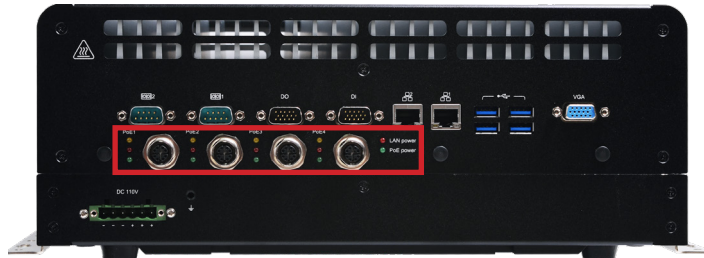

Pin Assignment

1	TX+
2	TX-
3	RX+
4	DC+ PoE
5	DC+ PoE
6	RX-
7	DC- PoE
8	DC- PoE

## x1 / x2 slots for CANbus or MVB connectors

On the back panel between SIM and SSD there are two slots for MVB or CANBus Connectors.

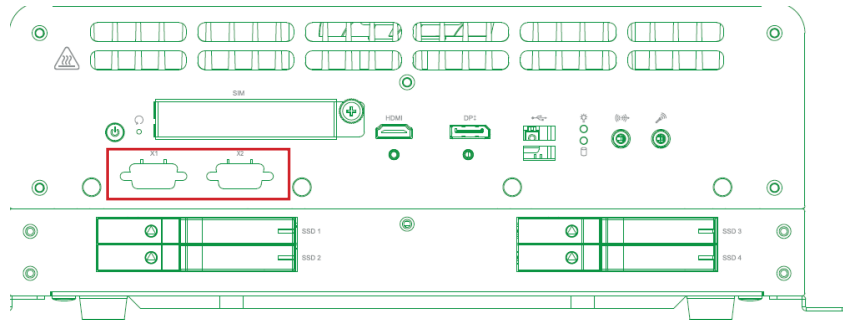

Please use a solid metal screwdriver or plier to push the metal plates attached to remove them.

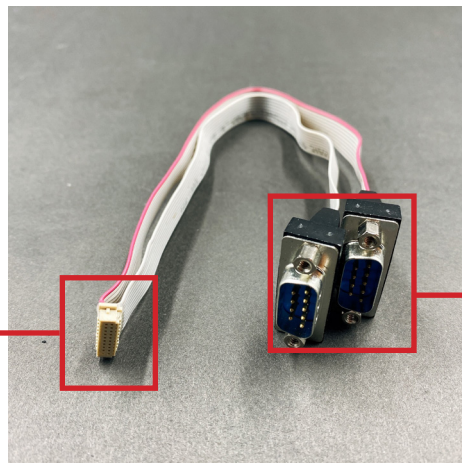

Connect to internal ports.

Fix them on the back plate.

## Pin Define of DI/DO

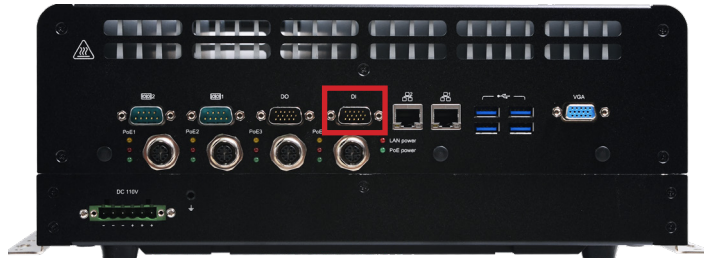

### DI

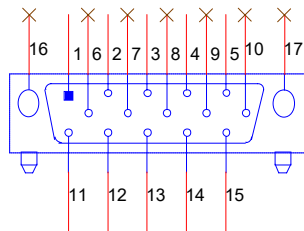

Pin	Assignment	Pin	Assignment
1	GPI0_ISO	10	NA
2	GPI2_ISO	11	GPI1_ISO
3	ISO_POWER	12	GPI3_ISO
4	GPI4_ISO	13	GPI5_ISO
5	GPI6_ISO	14	GPI7_ISO
6	NA	15	GND_ISO
7	NA	16	--
8	NA	17	--
9	NA	18	--

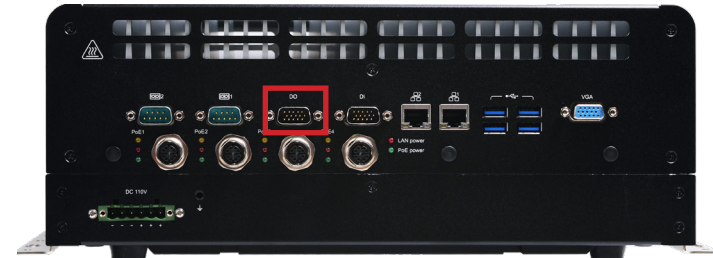

### DO

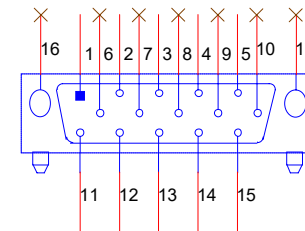

Pin	Assignment	Pin	Assignment
1	GPO0_ISO	10	NA
2	GPO2_ISO	11	GPO1_ISO
3	ISO_POWER	12	GPO3_ISO
4	GPO4_ISO	13	GPO5_ISO
5	GPO6_ISO	14	GPO7_ISO
6	NA	15	GND_ISO
7	NA	16	--
8	NA	17	--
9	NA	18	--



## Pin Define of COM1/2



### COM1

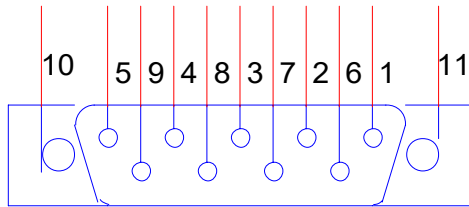

Pin	Assignment	Pin	Assignment
1	MDCD1-	7	MRTS1-
2	MSIN1	8	MCTS1-
3	MSOUT1	9	MRI1-
4	MDTR1-	10	AGND_COM
5	GND	11	AGND_COM
6	MDSR1-	12	--



### COM2

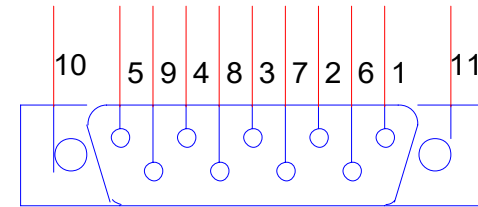

Pin	Assignment	Pin	Assignment
1	MDCD2-	7	MRTS2-
2	MSIN2	8	MCTS2-
3	MSOUT2	9	MRI2-
4	MDTR2-	10	AGND_COM
5	GND	11	AGND_COM
6	MDSR2-	12	--

10. The 2.5" SSD slots are located in the rear panel. Push the silver metal marked in red to eject the baffle.



12. Four slots follow the same procedure.



11. After the baffle has been ejected, you can insert or remove/replace the 2.5" storage devices by pulling or pushing them out/into the slots.



## Pin Define of DC110V



**DC 110V**

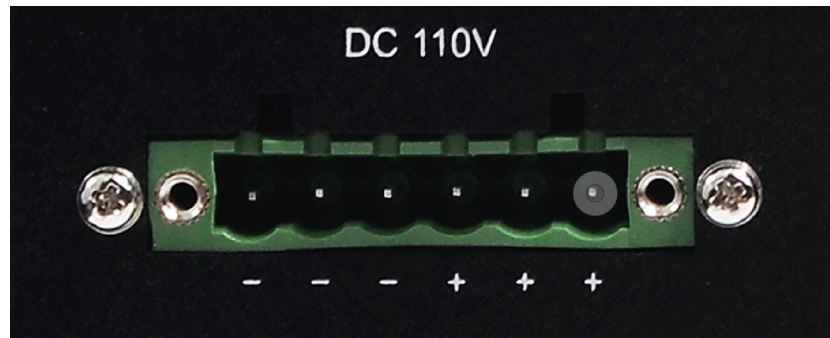

# Board Layout

## TOP

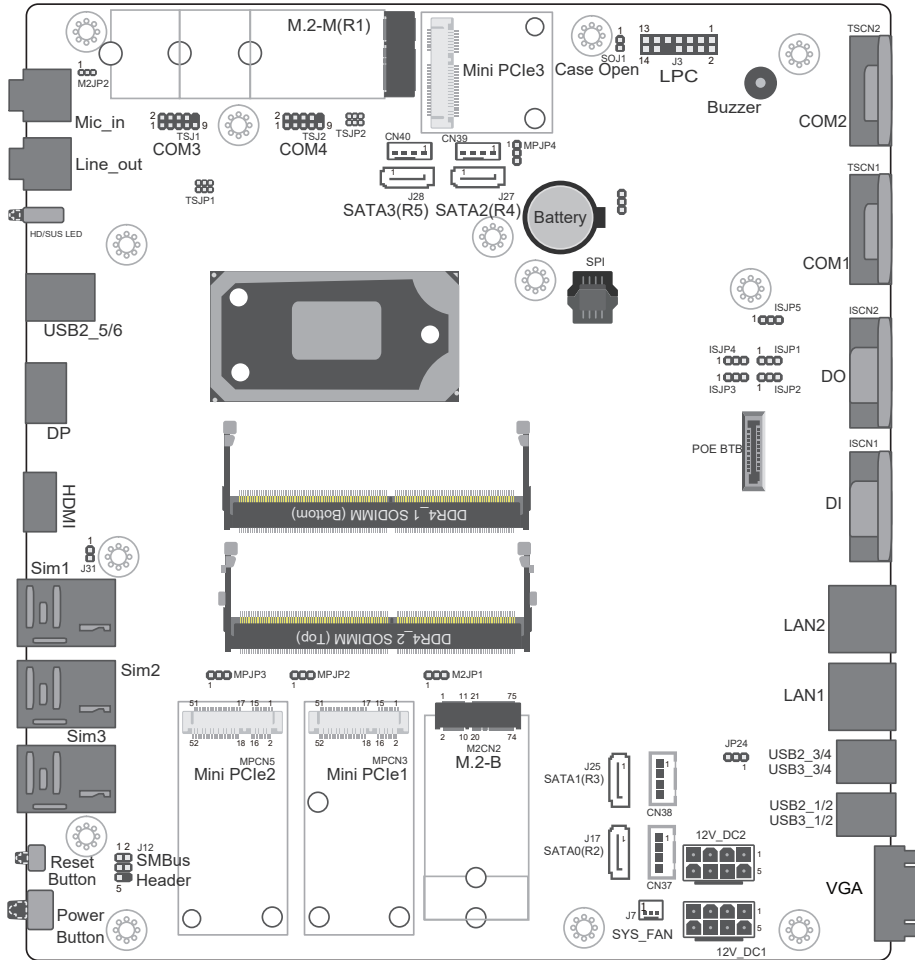

## BOTTOM

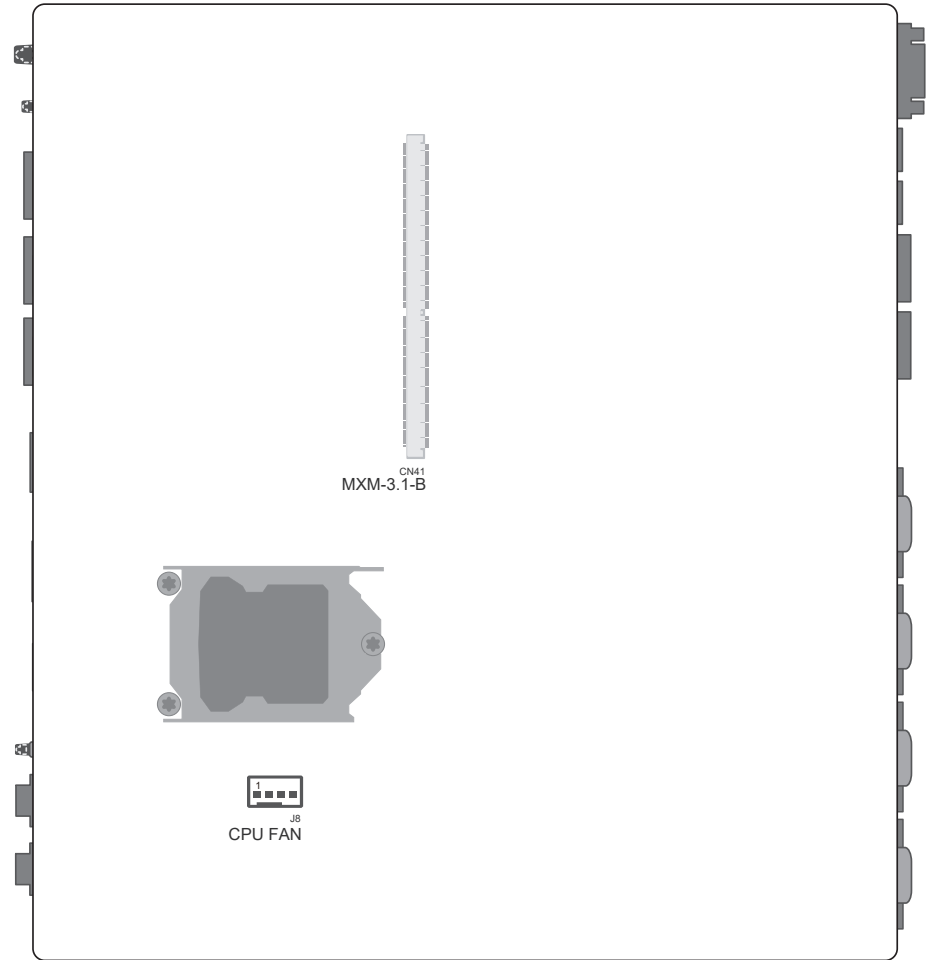

## Jumper Settings

### M2JP2 M.2 Socket (M key SATA only) Power

Switch the power of M.2 Socket.

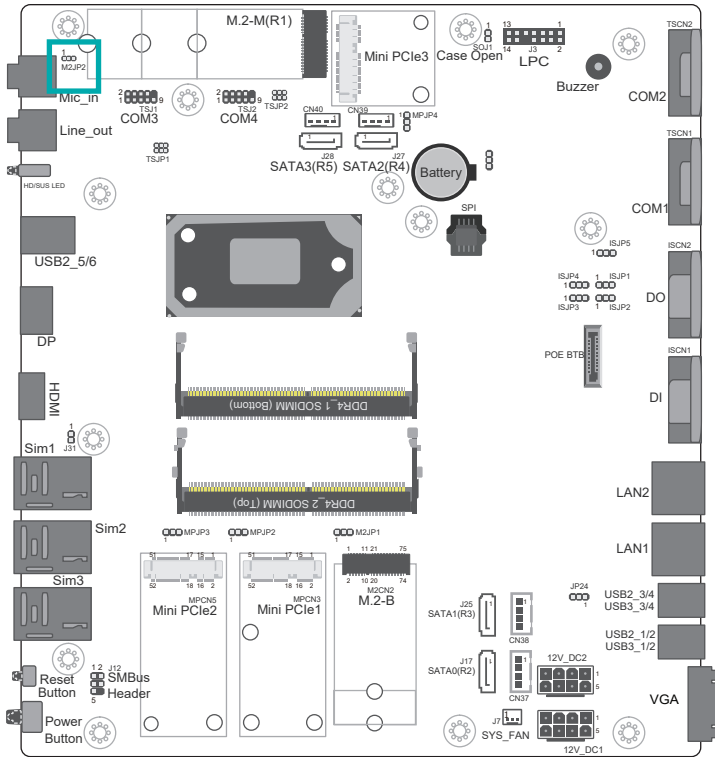

1



M.2 Socket Power	M2JP2
3V3 (default)	1-2 On
3V3SB	2-3 On

### MPJP4 Mini PCIe Power

Switch the power of Mini PCIe.

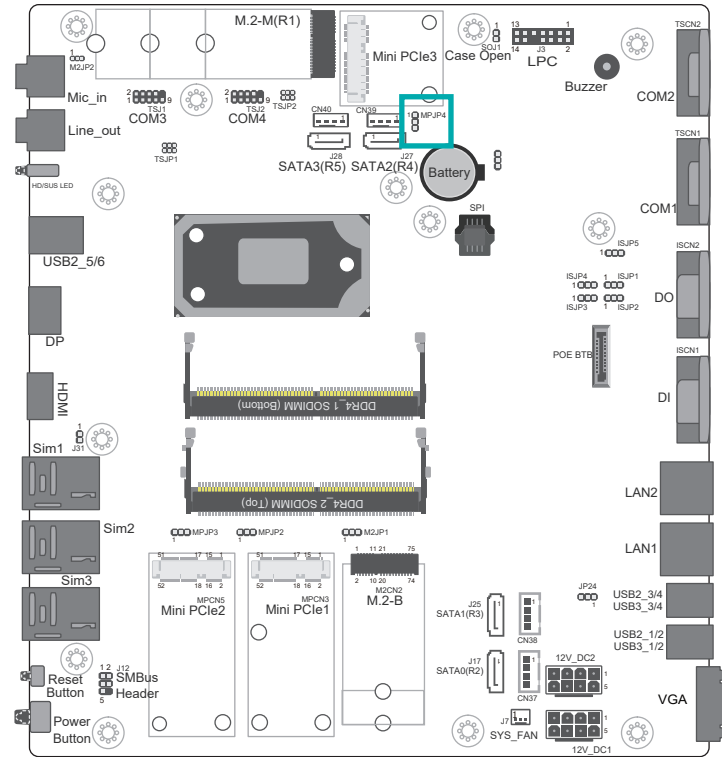

Mini PCIe Power	MPJP4
3V3SB (default)	1-2 On
3V3	2-3 On

## ISJP5 DIO Power

Switch the power of DIO.

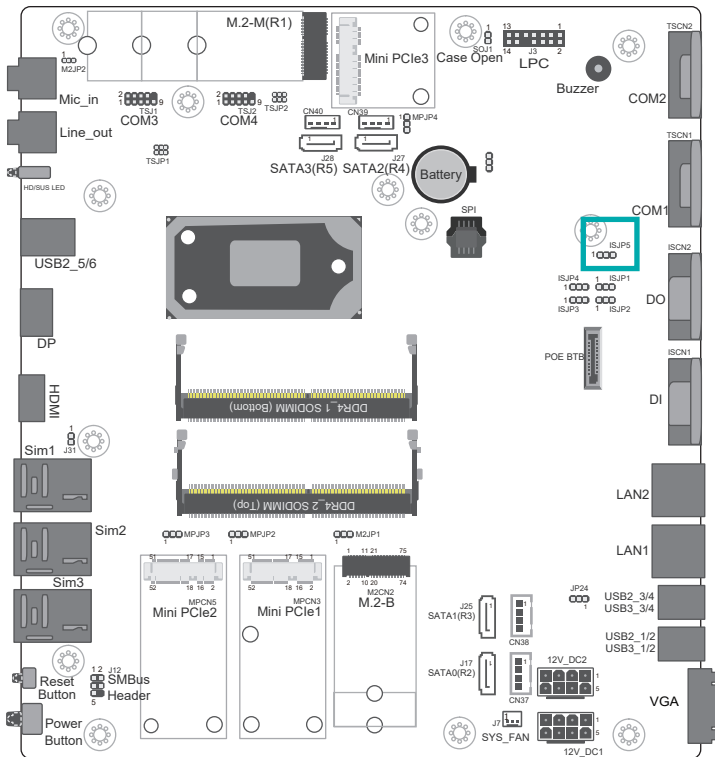

1



DIO Power	ISJP5
5VSB (default)	1-2 On
5V	2-3 On

## ISJP3 DI 4~7 Power

Switch the power of DI 4~7.

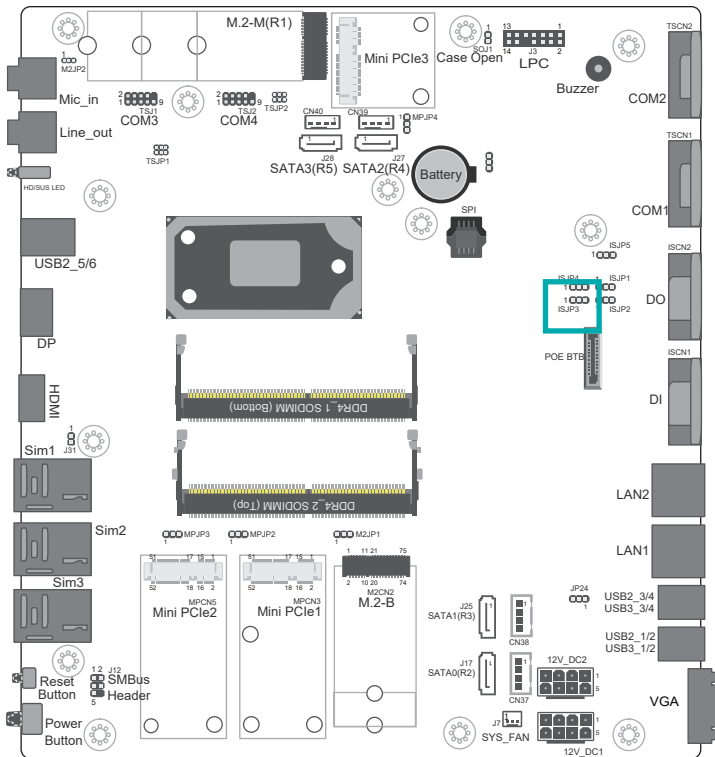

1



DI 4~7 Power	ISJP3
DIO PWR (default)	1-2 On
GND	2-3 On

## ISJP4 DI 0~3 Power

Switch the power of DI 0~3.

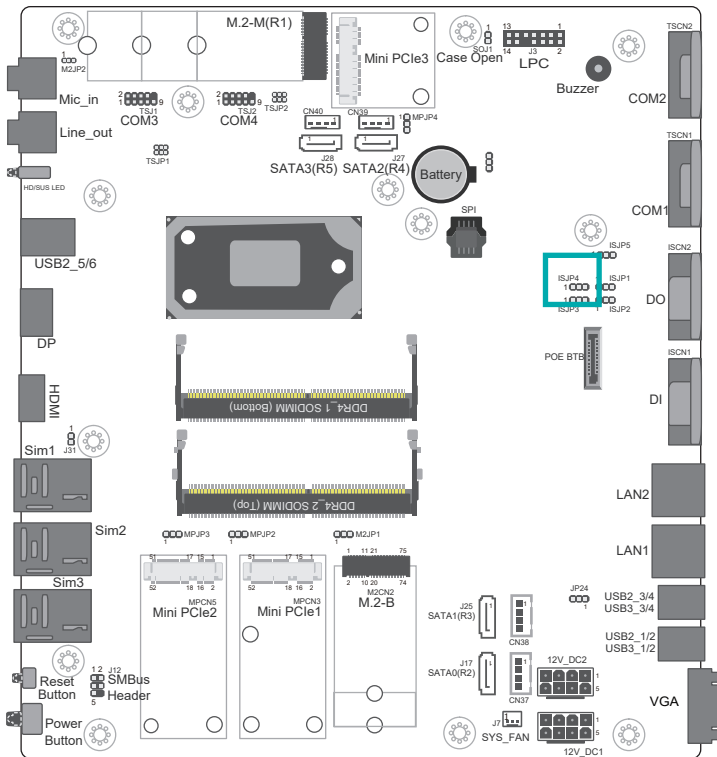

1



DI 0~3 Power	ISJP4
DIO PWR (default)	1-2 On
GND	2-3 On



### M2JP1 M.2 B KEY Power

Switch the power of M.2 B KEY.

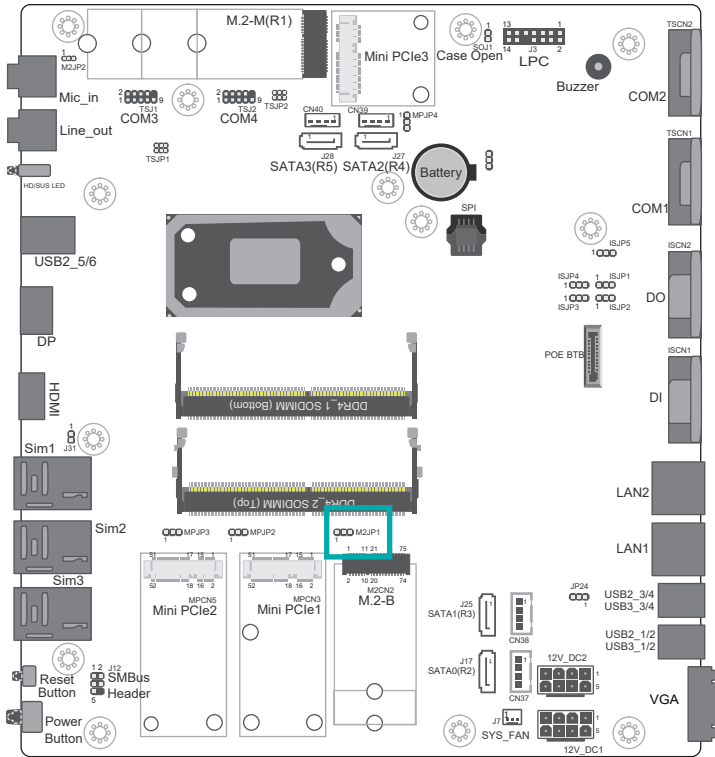

1



M.2 B KEY Power	M2JP1
3V3SB (default)	1-2 On
3V3	2-3 On

### MPJP2 Mini PCIe1 Power

Switch the power of Mini PCIe.

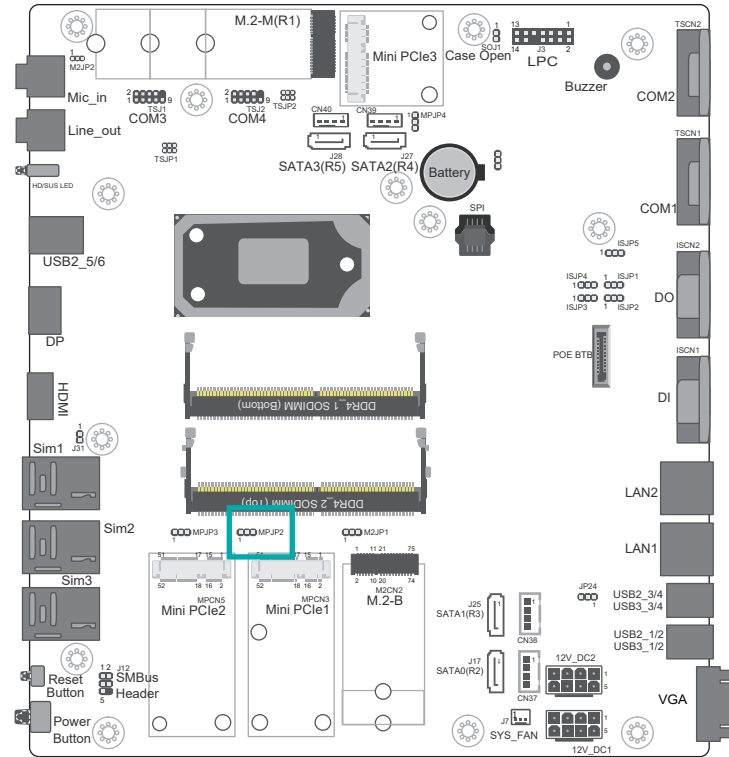

1



Mini PCIe1 Power	MPJP2
3V3SB (default)	1-2 On
3V3	2-3 On

## MPJP3 Mini PCIe2 Power

Switch the power of Mini PCIe.

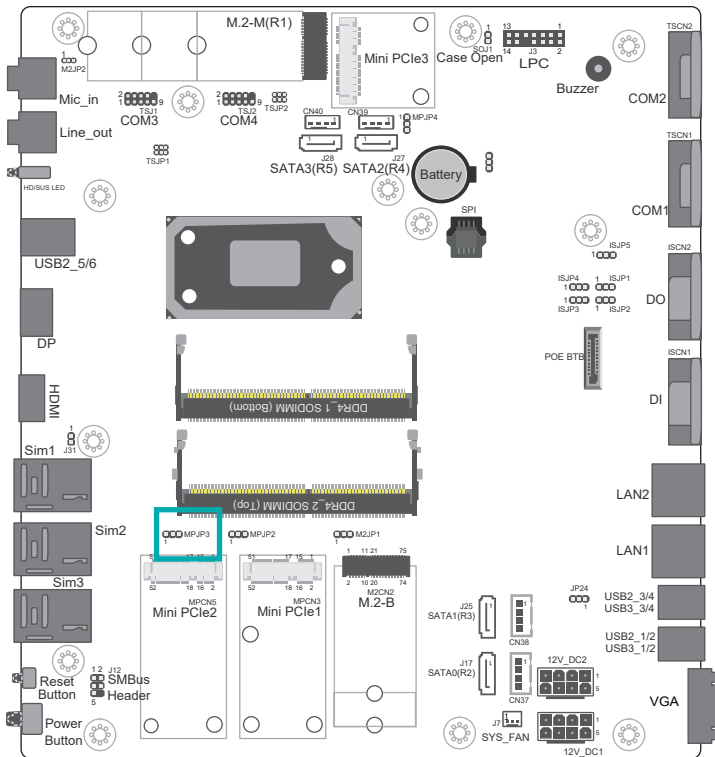

1



Mini PCIe2 Power	MPJP3
3V3SB (default)	1-2 On
3V3	2-3 On

## Internal Connectors

### TSJ1 COM3

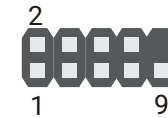
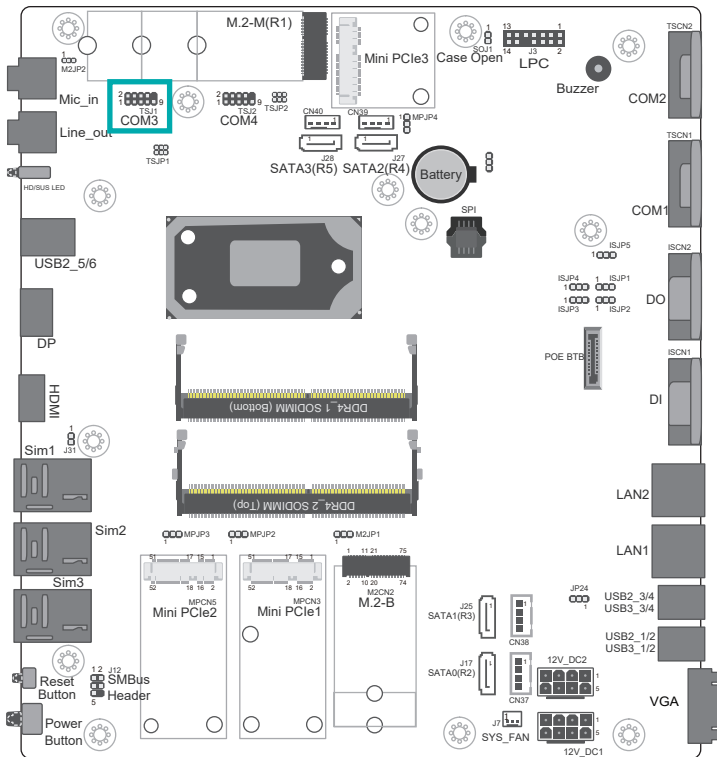

Pin	Function
1	X_MDCD3-
2	MSIN3
3	MSOUT3
4	MDTR3-
5	GND
6	MDSR3-
7	MRTS3-
8	MCTS3-
9	X_MRI3-

## TSJ2 COM4

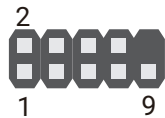
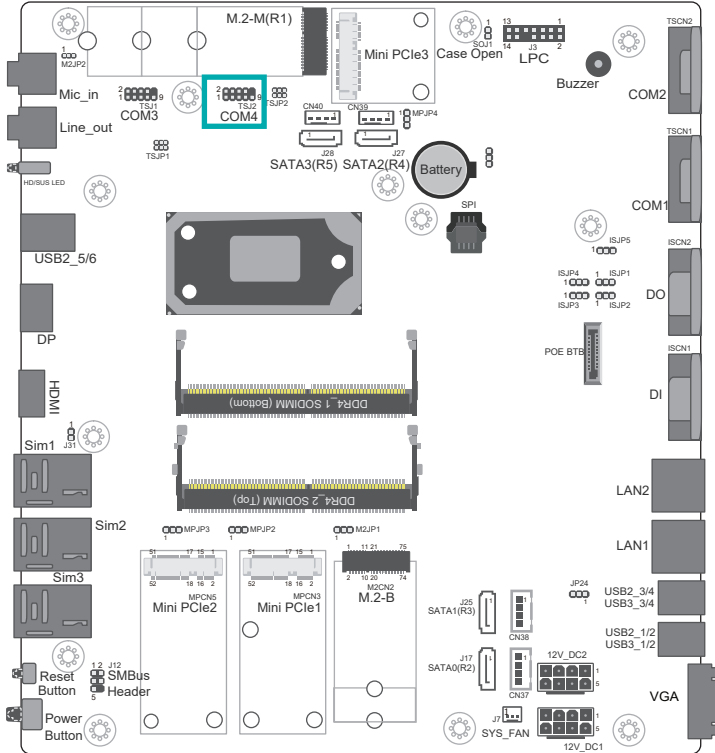

Pin	Function
1	X_MDCD4-
2	MSIN4
3	MSOUT4
4	MDTR4-
5	GND
6	MDSR4-
7	MRTS4-
8	MCTS4-
9	X_MR14-

## CN40 SATA3 Power

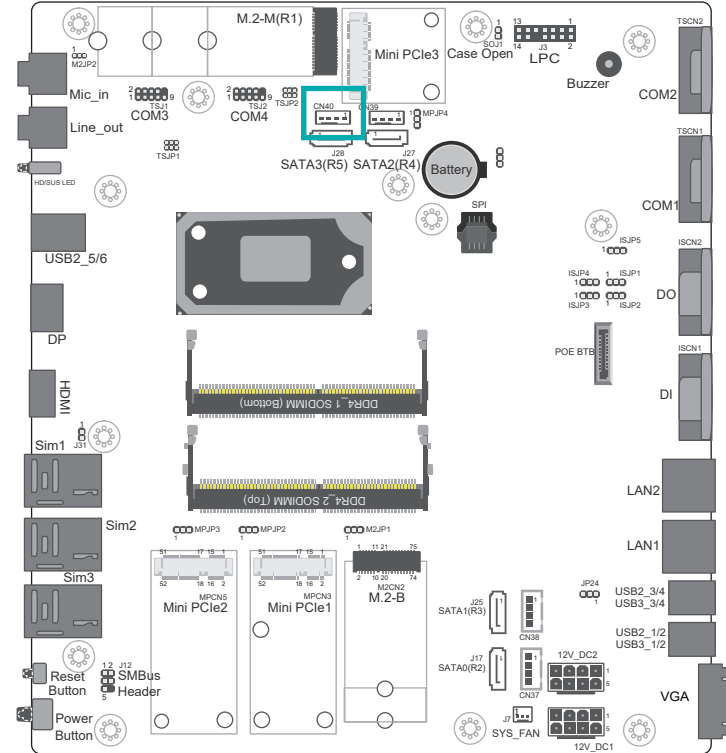

Pin	Function
1	+12V_SATA2
2	GND
3	GND
4	5V_SATA2

## CN39 SATA2 Power

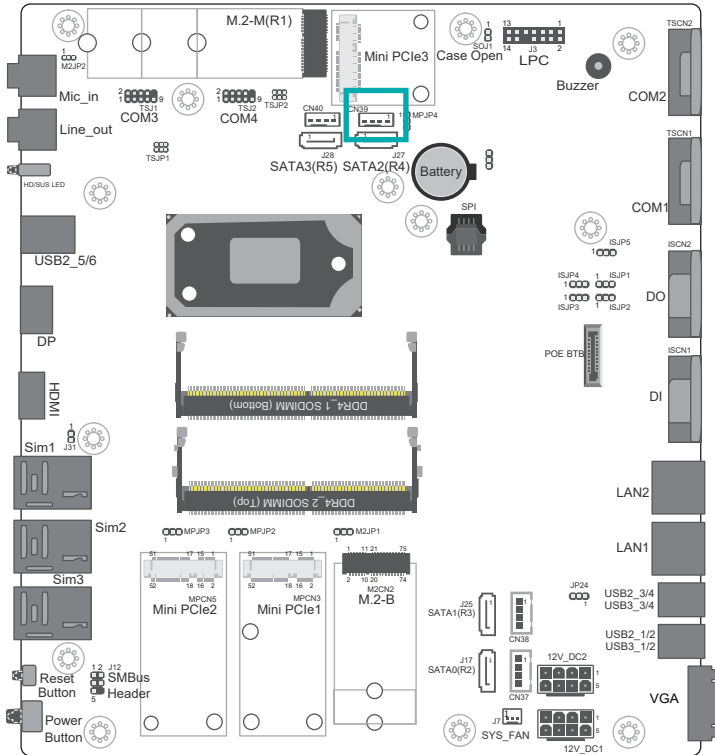

Pin	Function
1	+12V_SATA2
2	GND
3	GND
4	5V_SATA2



## CN37 SATA0 Power

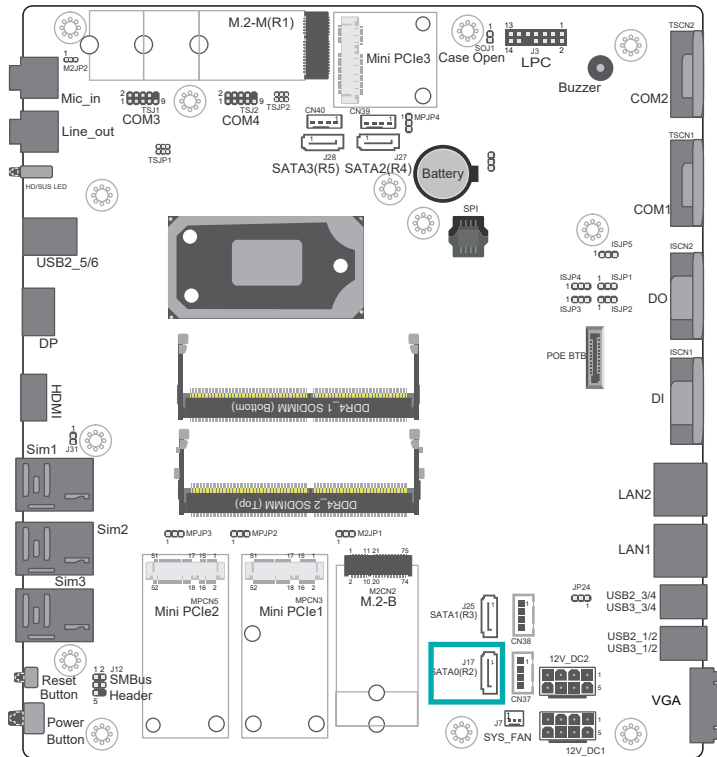

Pin	Function
1	+12V_SATA1
2	GND
3	GND
4	5V_SATA1

## J7 SYS FAN

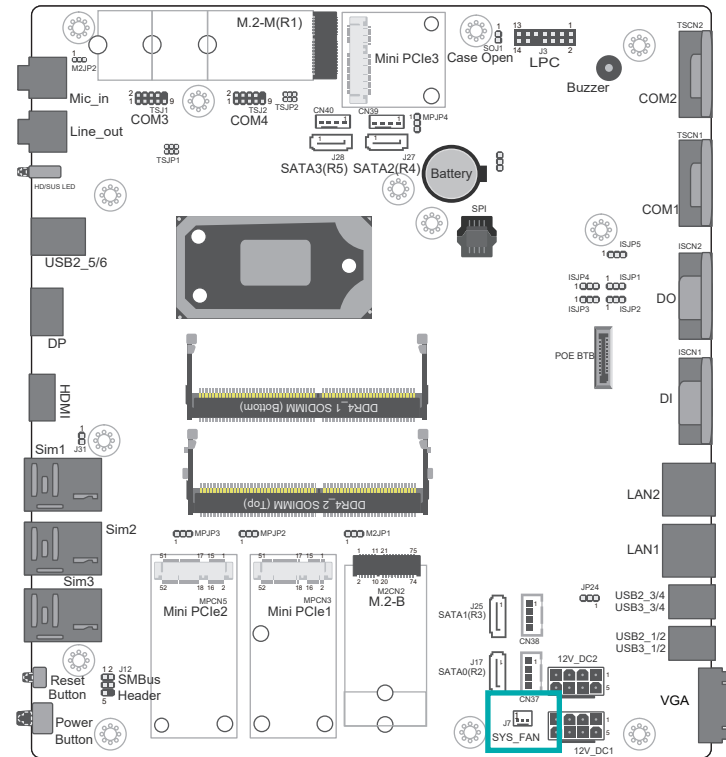

Pin	Function
1	GND
2	PWM
3	TACH

## M2CN2 M.2-B

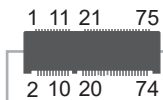
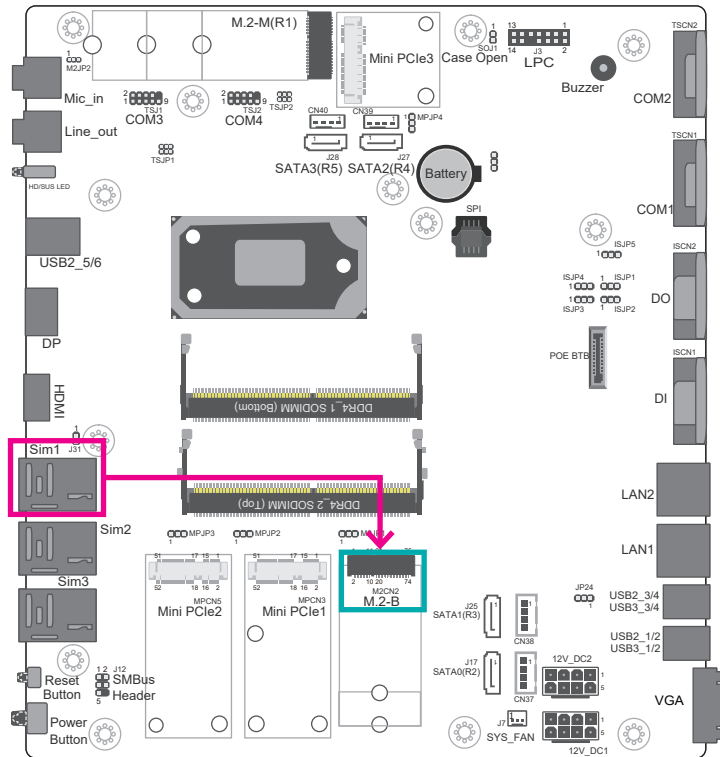

Pin	Function	Pin	Function
1		2	3V3_M2
3	GND	4	3V3_M2
5	GND	6	
7	M2B_CMC_USB2P	8	
9	M2B_CMC_USB2N	10	M2B_LED#
11	GND		

Pin	Function	Pin	Function
20	N.C.	21	
22	N.C.	23	
24	N.C.	25	
26	N.C.	27	GND
28	N.C.	29	M2B_USB3_RXN
30	M2B_UIMRST#	31	M2B_USB3_RXP
32	M2B_UIMCLK	33	GND
34	M2B_UIMDATA	35	USB3_TX_DN
36	SIM_PWR_1	37	USB3_TX_DP
38	M2B_DEVSLP	39	GND
40	M2BSMBCK_R	41	M2B_HSI_N
42	M2BSMBDAT_R	43	M2B_HSI_P
44	M2BSMBALERT#_R	45	GND
46	N.C.	47	M2B_HSO_N
48	N.C.	49	M2B_HSO_P
50	mPCIE_RST-	51	GND
52		53	CLKOUT_mPCIE_N
54	M2B_WAKE#	55	CLKOUT_mPCIE_P
56	N.C.	57	GND
58	N.C.	59	N.C.
60	N.C.	61	N.C.
62	N.C.	63	N.C.
64	N.C.	65	N.C.
66	M2B_SIM_DET	67	M2B_RESET#_R
68	N.C.	69	
70	3V3_M2	71	GND
72	3V3_M2	73	GND
74	3V3_M2	75	



## MPCN3 Mini PCIe1

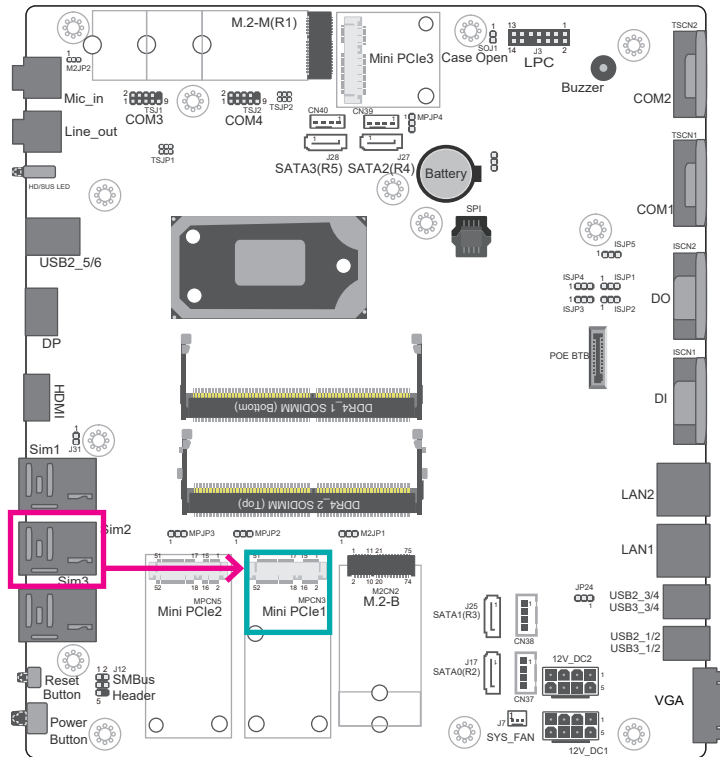

Pin	Function	Pin	Function
1	mPCIE_R_WAKE#	2	GND
3	N.C.	4	GND
5	N.C.	6	GND
7	N.C.	8	SIM_PWR_
9	GND	10	SIM_IO_
11	CLKOUT_mPCIE_N	12	SIM_CLK_
13	CLKOUT_mPCIE_P	14	SIM_RESET_
15	GND	16	SIM_VPP_

Pin	Function	Pin	Function
17	N.C.	18	GND
19	N.C.	20	N.C.
21	GND	22	mPCIE_RST-
23	HSI_N_	24	3V3_MINI2
25	HSI_P_	26	GND
27	GND	28	1V5_MINI
29	GND	30	SMB_CLK_RESUME
31	HSO_N_	32	SMB_DATA_RESUME
33	HSO_P_	34	GND
35	GND	36	USB2_N
37	GND	38	USB2_P
39	GND	40	GND
41	GND	42	
43	GND	44	
45	N.C.	46	
47	N.C.	48	1V5_
49	N.C.	50	GND
51	N.C.	52	3V3_
53	GND	54	GND
55	N.C.	56	GND

## MPCN5 Mini PCIe2

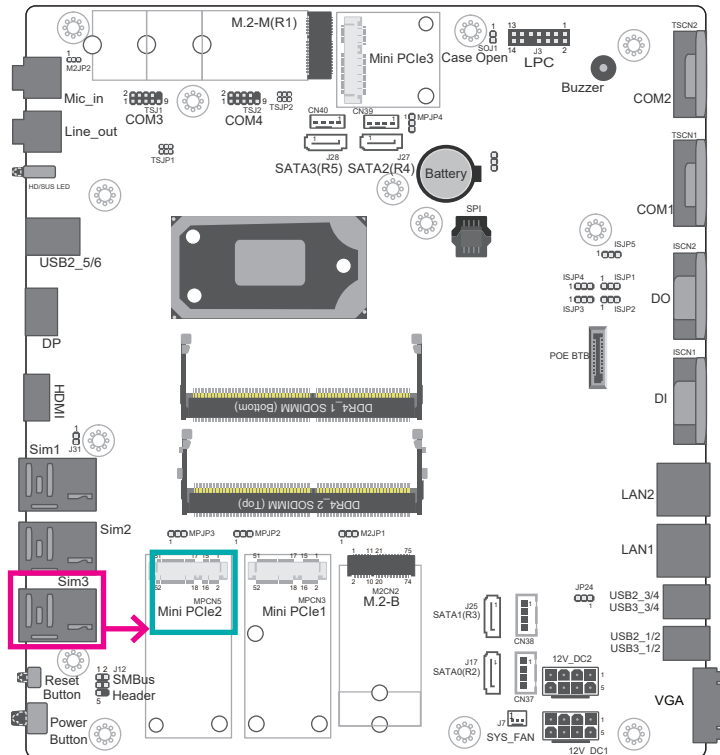

Pin	Function	Pin	Function
1	mPCIE_3_R_WAKE#	2	GND
3	N.C.	4	GND
5	N.C.	6	GND
7	N.C.	8	SIM_PWR_3
9	GND	10	SIM_IO_3
11	CLKOUT_mPCIE_N3	12	SIM_CLK_3
13	CLKOUT_mPCIE_P3	14	SIM_RESET_3
15	GND	16	SIM_VPP_3

Pin	Function	Pin	Function
17	N.C.	18	GND
19	N.C.	20	N.C.
21	GND	22	mPCIE_RST-
23	HSI_7N_C	24	3V3_MINI3
25	HSI_7P_C	26	GND
27	GND	28	1V5_MINI
29	GND	30	SMB_CLK_RESUME
31	HSO_7N_C	32	SMB_DATA_RESUME
33	HSO_7P_C	34	GND
35	GND	36	USB2_9_C_N
37	GND	38	USB2_9_C_P
39	GND	40	GND
41	GND	42	MPTP7
43	GND	44	MPTP8
45	N.C.	46	MPTP9
47	N.C.	48	1V5_MINI
49	N.C.	50	GND
51	N.C.	52	3V3_MINI3
53	GND	54	GND
55	N.C.	56	GND

## J12 SMBus Header

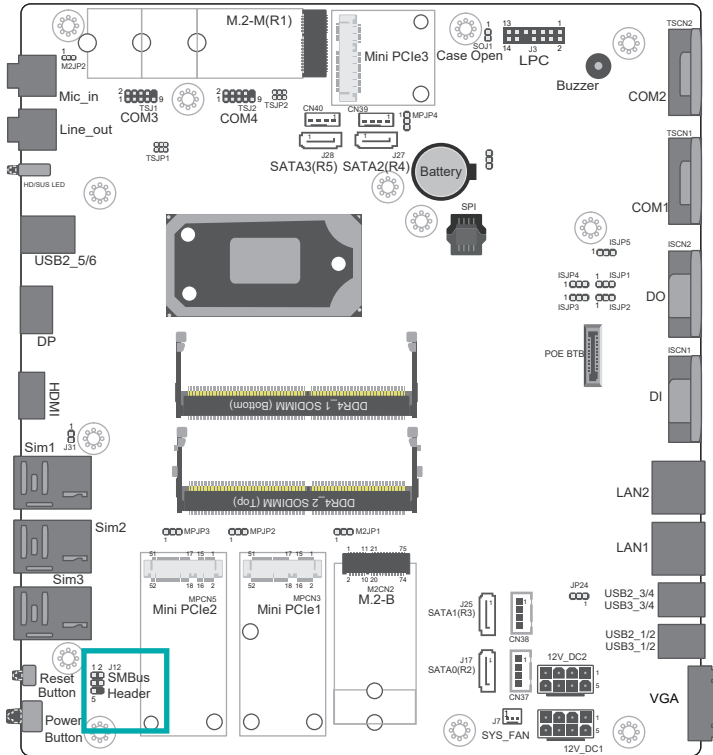

Pin	Function	Pin	Function
1	3V3SB	2	GND
3	SMB_CLK_RESUME	4	SMB_DATA_RESUME
5	SMBALERT_PCH-		

## Chapter 4 - BIOS Setup

### Overview

The BIOS is a program that takes care of the basic level of communication between the CPU and peripherals. It contains codes for various advanced features found in this system board. The BIOS allows you to configure the system and save the configuration in a battery-backed CMOS so that the data retains even when the power is off. In general, the information stored in the CMOS RAM of the EEPROM will stay unchanged unless a configuration change has been made such as a hard drive replaced or a device added.

It is possible that the CMOS battery will fail causing CMOS data loss. If this happens, you need to install a new CMOS battery and reconfigure the BIOS settings.



**Note:**

The BIOS is constantly updated to improve the performance of the system board; therefore the BIOS screens in this chapter may not appear the same as the actual one. These screens are for reference purpose only.

### Default Configuration

Most of the configuration settings are either predefined according to the Load Optimal Defaults settings which are stored in the BIOS or are automatically detected and configured without requiring any actions. There are a few settings that you may need to change depending on your system configuration.

### Entering the BIOS Setup Utility

The BIOS Setup Utility can only be operated from the keyboard and all commands are keyboard commands. The commands are available at the right side of each setup screen.

The BIOS Setup Utility does not require an operating system to run. After you power up the system, the BIOS message appears on the screen and the memory count begins. After the memory test, the message "Press DEL to run setup" will appear on the screen. If the message disappears before you respond, restart the system or press the "Reset" button. You may also restart the system by pressing the <Ctrl> <Alt> and <Del> keys simultaneously.

### Legends

Keys	Function
Right and Left arrows	Move the highlight left or right to select a menu.
Up and Down arrows	Move the highlight up or down between submenu or fields.
+ (plus key)	Scroll forward through the values or options of the highlighted field
- (minus key)	Scroll backward through the values or options of the highlighted field
<Esc>	Return to previous menu
<F1>	Display general help
<F2>	Display previous values
<F9>	Optimized defaults
<F10>	Save and Exit
<Enter>	Press <Enter> to enter the highlighted submenu.

### Scroll Bar

When a scroll bar appears to the right of the setup screen, it indicates that there are more available fields not shown on the screen. Use the up and down arrow keys to scroll through all the available fields.

### Submenu

When "►" appears on the left of a particular field, it indicates that a submenu which contains additional options are available for that field. To display the submenu, move the highlight to that field and press <Enter>.

## Aptio BIOS Setup Utility

### Main

The Main menu is the first screen that you will see when you enter the BIOS Setup Utility.

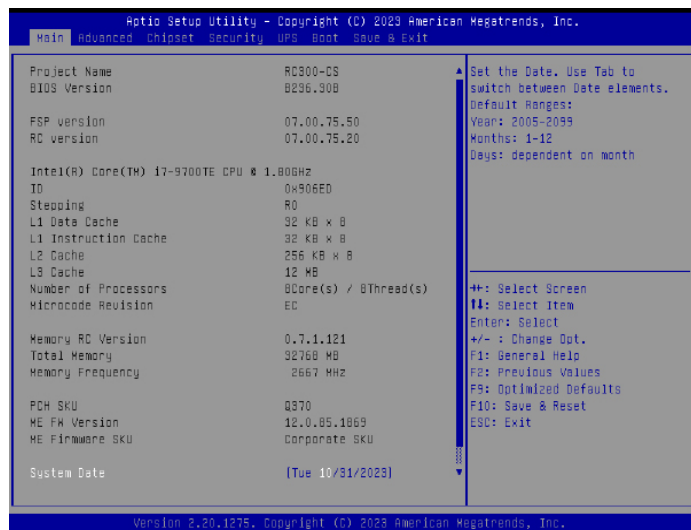

### System Date

The date format is <month>, <date>, <year>. Month displays the month, from January to December. Date displays the date, from 1 to 31. Year displays the year, from 2005 to 2099.

### System Time

The time format is <hour>, <minute>, <second>. The time is based on the 24-hour military-time clock. For example, 1 p.m. is 13:00:00. Hour displays hours from 00 to 23. Minute displays minutes from 00 to 59. Second displays seconds from 00 to 59.

## Advanced

The Advanced menu allows you to configure your system for basic operation. Some entries are defaults required by the system board, while others, if enabled, will improve the performance of your system or let you set some features according to your preference.



### Important:

Setting incorrect field values may cause the system to malfunction.



## RC ACPI Settings

Configure power management related settings in this page.

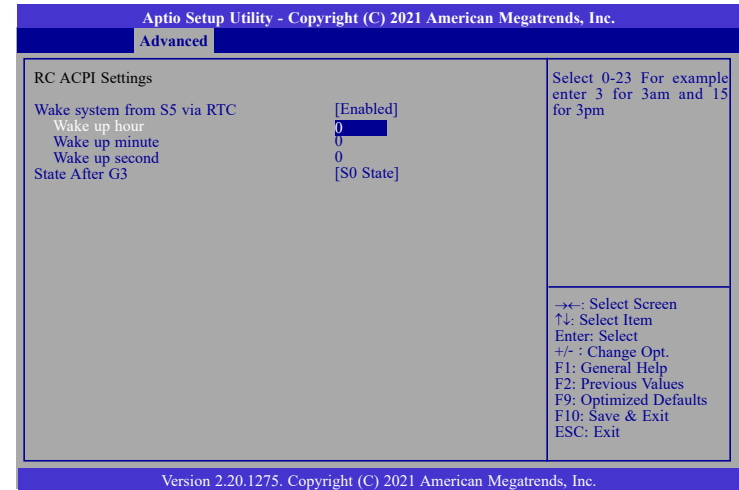
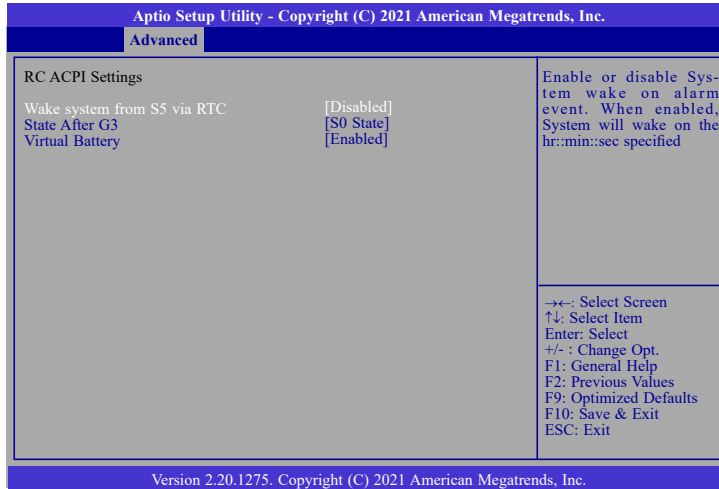

### Wake system from S5 via RTC

When Enabled, the system will automatically power up at a designated time every day from the Real-time clock (RTC) battery. More settings will be displayed once it's switched to [Enabled] as detailed in the next page.

### State After G3

Select between S0 State, Last State, and S5 State. This field is used to specify what state the system is set to return to when power is re-applied after a power failure (G3 state).

### Virtual Battery

Enable or disable virtual battery, it's for MXM RTX20xx and its above versions. If enabled, the system supports S4(Suspend to disk mode) if WIN10 PCH driver installed.

When "Wake system from S5" is enabled, the following fields will appear.

### Wake up hour

Press +/- to set the hour from 0 to 23.

### Wake up minute

Press +/- to set the minute from 0 to 59.

### Wake up second

Press +/- to set the second from 0 to 59.

## CPU Configuration

This section configures the CPU.

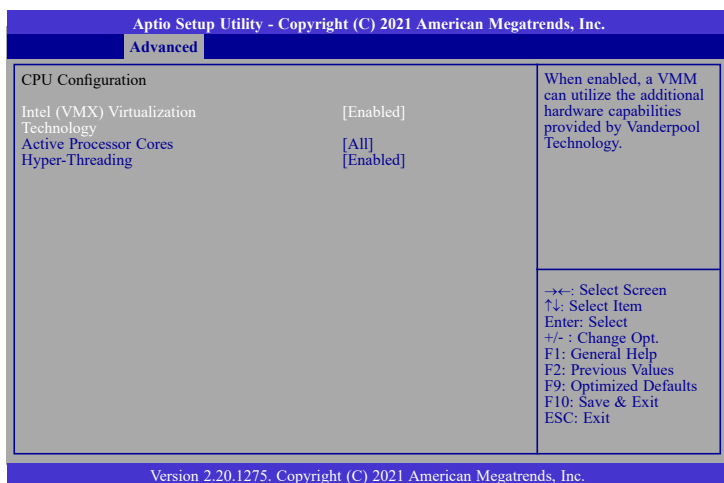

### Intel (VMX) Virtualization Technology

When this field is enabled, the VMM can utilize the additional hardware capabilities provided by Vanderpool Technology.

### Active Processor Cores

Select number of cores to be enabled in each processor package.

### Hyper-Threading

Enable or disable Hyper-threading. When it is enabled, a physical core will perform as two logical processors, and the user may experience better computational efficiency of the system. Please make sure that the OS operating on your system is optimized for Hyper-Threading, e.g. Windows and Linux. This field is not available when the equipped CPU does not support Hyper-threading.

## Power & Performance

Configure the power and performance settings in this page.

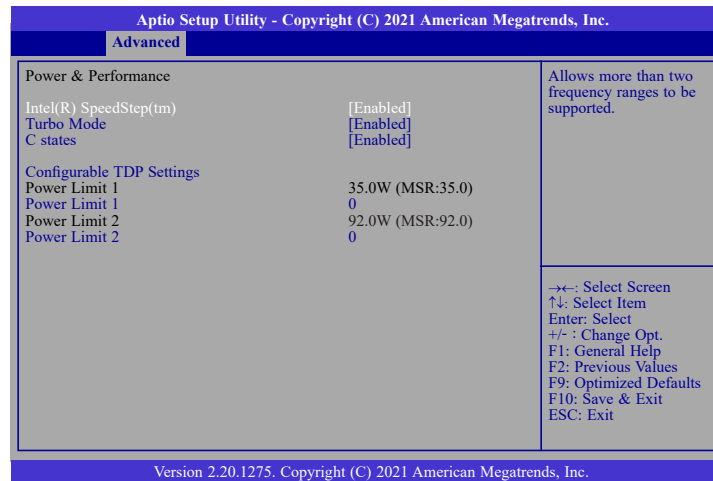

### Intel(R) SpeedStep(tm)

Enable or disable Intel Enhanced SpeedStep Technology. Voltage and frequency are switched between high and low levels in response to processor load when this field is enabled, and the Turbo Mode field will appear.

### Turbo Mode

Enable or disable processor turbo mode, which allows the processor core to automatically run faster than the base frequency when the processor's power, temperature, and specification are within the limits of TDP. This field is only available when "Intel(R) SpeedStep(tm)" is enabled.

### C states

Enable or disable CPU Power Management. When enabled, the CPU is allowed to go to C states when it's not 100% utilized.

### Configurable TDP Settings

Configure PL1 and PL2 range.

## PCH-FW Configuration

Configure the parameters of Management Engine Technology.

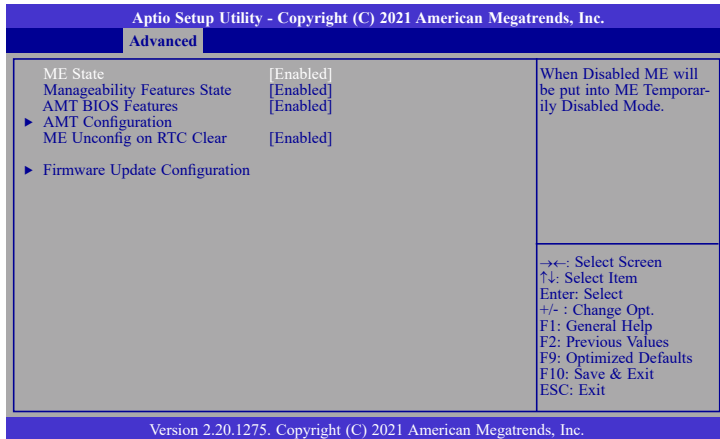

### ME State

Enable or disable Management Engine. When this field is set to Disabled, ME will be put into ME Temporarily Disabled Mode. The following fields will only appear when ME State is enabled.

### Manageability Features State

Enable or disable Intel(R) Manageability features. This option disables/enables Manageability Features support in FW. To disable, support platform must be in an unprovisioned state first.

### AMT BIOS Features

When disabled, AMT BIOS features are no longer supported and user is no longer able to access MEBx Setup. This option does not disable manageability features in FW.

### ▶ AMT Configuration

This section is used to configure Intel(R) Active Management Technology Parameters. Please refer to the following pages.

### ME Unconfig on RTC Clear

When disabled, ME will not be unconfigured on RTC Clear.

### ▶ Firmware Update Configuration

Please refer to the following pages.

## ▶ AMT Configuration

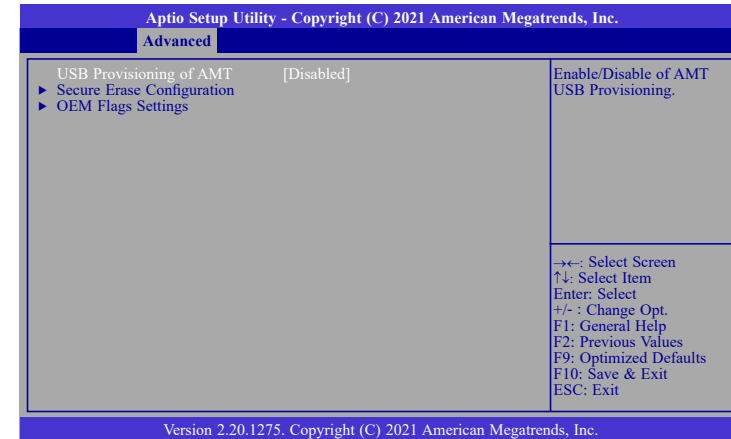

### USB Provisioning of AMT

Enable or disable AMT USB Provisioning.

### ▶ Secure Erase Configuration

Please refer to the following pages.

### ▶ OEM Flags Settings

Please refer to the following pages.



► **AMT Configuration ► Secure Erase Configuration**

This section is used to configure Secure Erase.

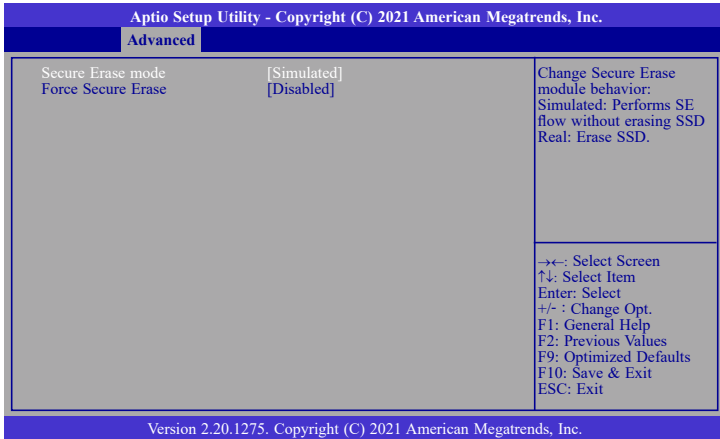

**Secure Erase Mode**

Select Secure Erase module behavior: Simulated or Real.

**Force Secure Erase**

Enable or disable Force Secure Erase on next boot.

► **AMT Configuration ► OEM Flags Settings**

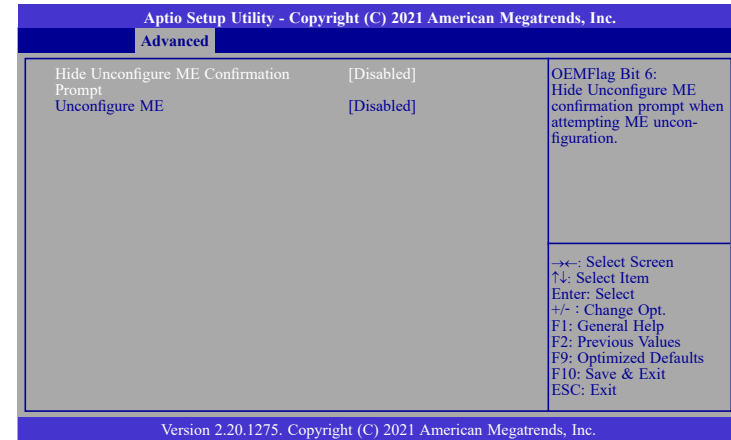

**Hide Unconfigure ME Confirmation Prompt**

Enable or disable to hide unconfigure ME confirmation prompt when attempting ME unconfiguration.

**Unconfigure ME**

Enable or disable to unconfigure ME with resetting MEBx password to default.

## ► Firmware Update Configuration

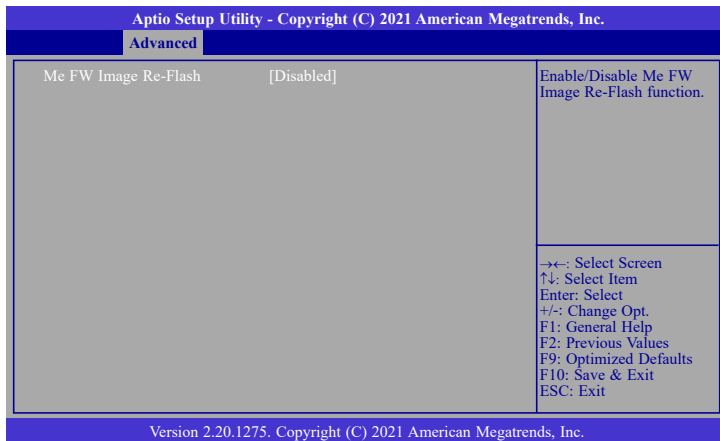

### **Me FW Image Re-Flash**

This field is used to enable or disable the Me FW Image Re-Flash function.

## Trusted Computing

Configure Trusted Computing settings.

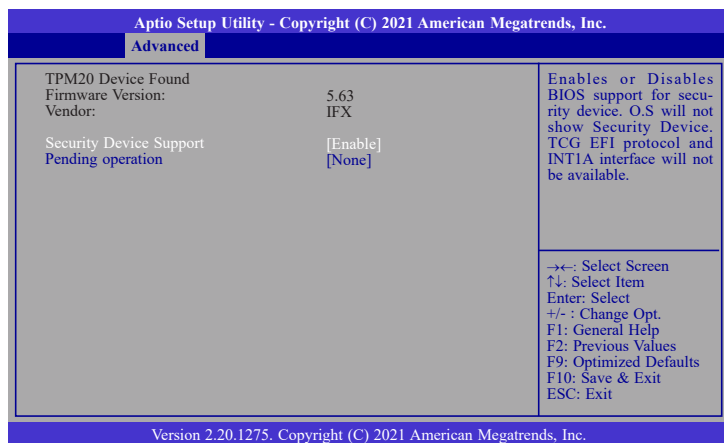

### Security Device Support

This field is used to enable or disable BIOS support for the security device. A security device will not be shown on the OS. TCG EFI protocol and INT1A interface will not be available.

### Pending operation

Schedule an operation for the security device. Your computer will reboot during restart in order to change state of the security device.

## NCT6116D Super IO Configuration

This section is used to configure the I/O functions supported by the onboard Super I/O chip.

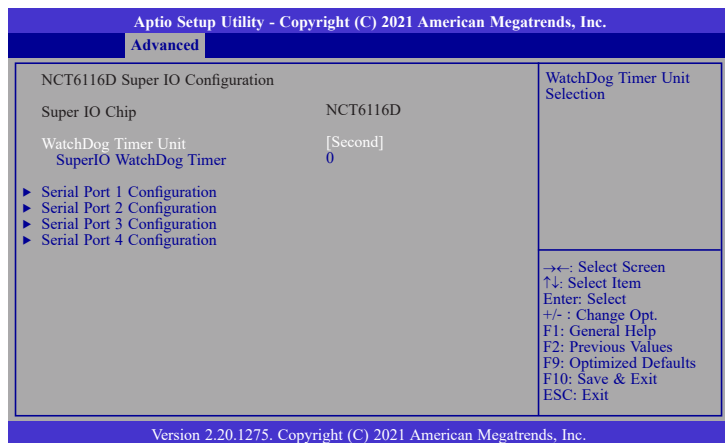

### WatchDog Timer Unit

Select WatchDog Timer Unit: Second or Minute.

### SuperIO WatchDog Timer

Set SuperIO WatchDog Timer Timeout value. The range is from 0 (disabled) to 255.

### ► Serial Port 1/2/3/4 Configuration

Configure the parameters of serial port 1 (COM 1) to serial port 4 (COM 4) as detailed later.

## ► Serial Port 1/2/3/4 Configuration

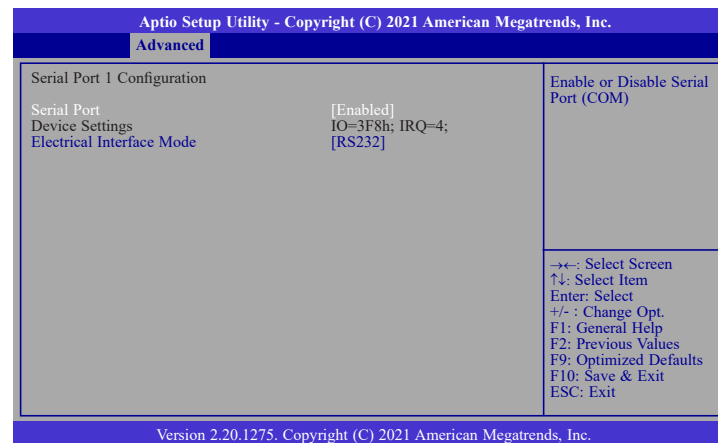

### Serial Port

Enable or disable the serial COM port.

### Electrical Interface Mode

Determine the electrical interface mode.

## NCT6116D HW Monitor

This section displays the hardware health monitor.

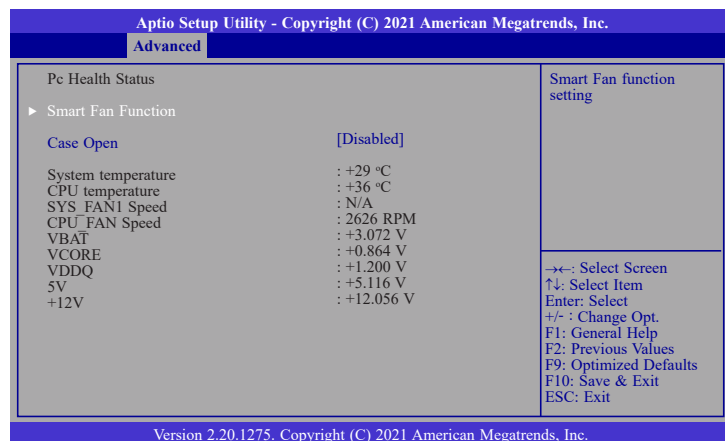

### ▶ Smart Fan Function

Please refer to the following pages.

#### Case Open

Enable or disable the case open detection function.

### ▶ Smart Fan Function

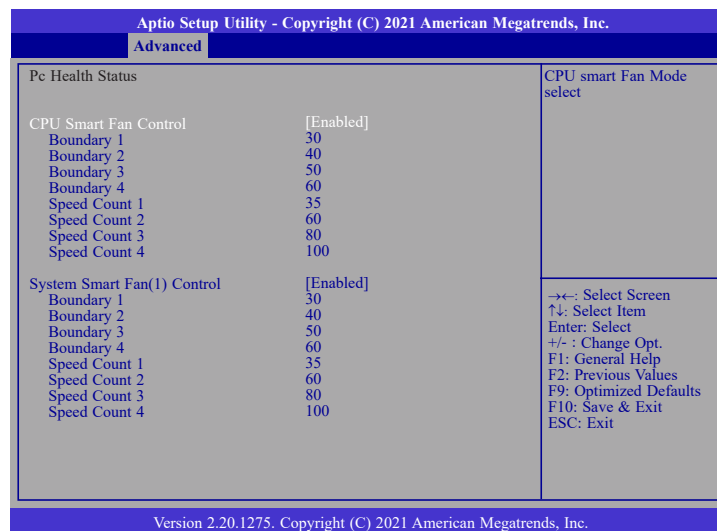

### Smart Fan Control

Enable or disable the smart fan.

#### Boundary 1 to Boundary 4

Set the boundary temperatures that determine the fan speeds accordingly, the value ranging from 0-127C. For example, when the system temperature reaches Boundary 1 setting, the fan speed will be turned up to the designated speed of the Fan Speed Count 1 field.

#### Speed Count 1 to Speed Count 4

Set the fan speed, the value ranging from 1-100%, 100% being full speed. The fans will operate according to the specified boundary temperatures above-mentioned.

## Serial Port Console Redirection

This section configures settings relevant to serial port console redirection.

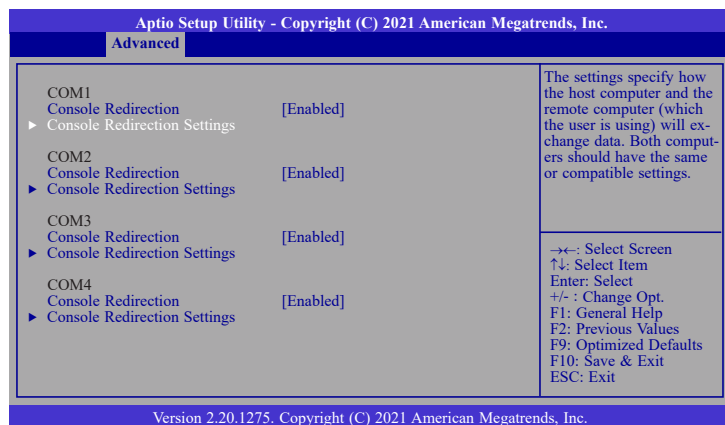

### Console Redirection

This field is used to enable or disable the console redirection function. When console redirection is set to enabled, console redirection settings are available as instructed below.

## ► Console Redirection Settings

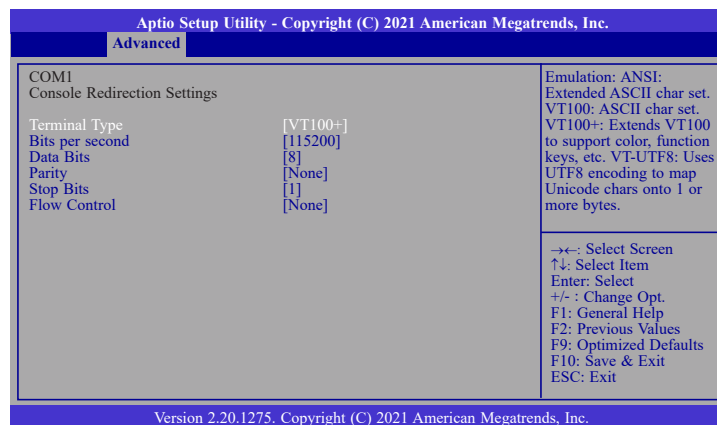

### Terminal Type

Select terminal type: VT100, VT100+, VT-UTF8 or ANSI.

### Bits per second

Select serial port transmission speed: 9600, 19200, 38400, 57600 or 115200.

### Data Bits

Select data bits: 7 bits or 8 bits.

### Parity

Select parity bits: None, Even, Odd, Mark or Space.

### Stop Bits

Select stop bits: 1 bit or 2 bits.

### Flow Control

Select flow control: None or Hardware RTS/CTS.

## USB Configuration

This section is used to configure the USB settings.

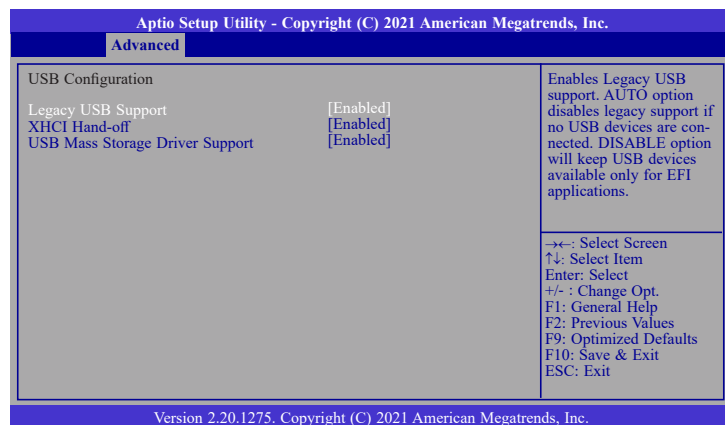

### Legacy USB Support

**Enabled** Enable Legacy USB support.

**Disabled** Keep USB devices available only for EFI applications.

**Auto** Disable Legacy support if no USB devices are connected.

### XHCI Hand-off

Enable or disable XHCI Hand-off.

### USB Mass Storage Driver Support

Enable or disable USB Mass Storage Driver Support.

## CSM Configuration

This section is used to configure the CSM settings.

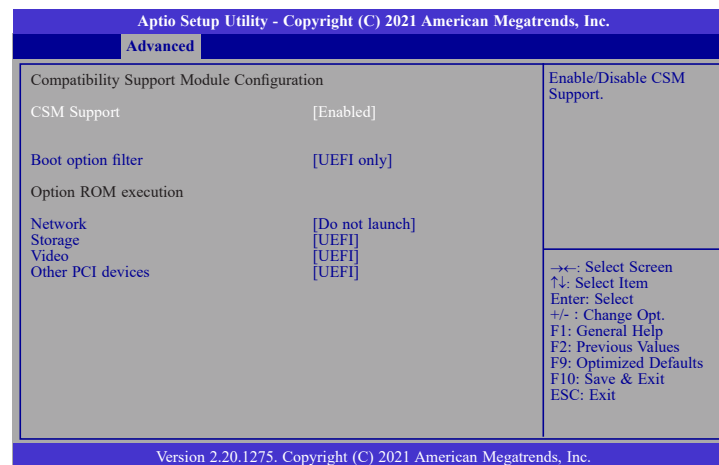

### CSM Support

This section is used to enable or disable CSM Support. When CSM Support is set to enabled, several options will appear for configuration.

### Boot option filter

This field controls Legacy/UEFI ROMs priority.

### Network

This field controls the execution of UEFI and Legacy Network OpROM.

### Storage

This field controls the execution of UEFI and Legacy Storage OpROM.

### Video

This field controls the execution of UEFI and Legacy Video OpROM.

### Other PCI devices

This field determines OpROM execution policy for devices other than Network, Storage or Video.

## USB Power Control

Configure USB port power voltage.

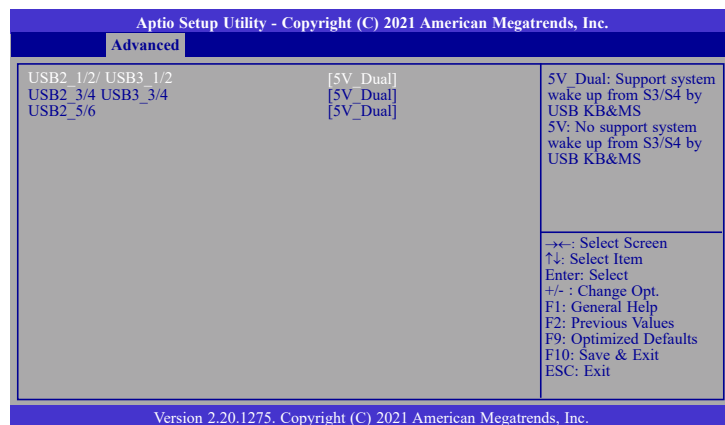

### USB3\_1/2/3/4&USB2\_1/2/3/4/5/6

Select the power voltage for USB 1-8 — 5V\_Dual or 5V.

## Network Stack Configuration

This section is used to configure the Network Stack settings.

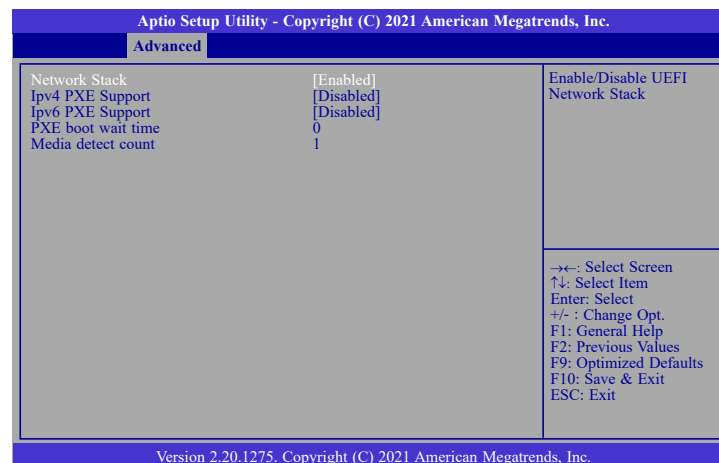

### Network Stack

This section is used to enable or disable UEFI network stack. When Network Stack is enabled, the following fields will appear.

#### Ipv4 PXE Support

Enable or disable IPv4 PXE boot support. If disabled, IPv4 PXE boot support will not be available.

#### Ipv6 PXE Support

Enable or disable IPv6 PXE boot support. If disabled, IPv6 PXE boot support will not be available.

#### PXE boot wait time

Set the wait time in seconds to press ESC key to abort the PXE boot. Use either +/- or numeric keys to set the value.

#### Media detect count

Set the number of times the presence of media will be checked. Use either +/- or numeric keys to set the value.



## Chipset

This section configures relevant chipset functions.

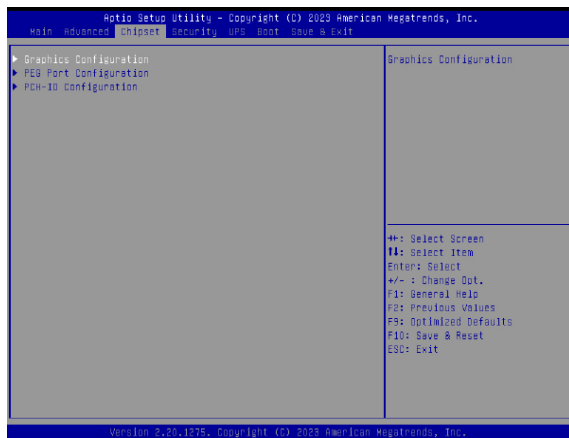

### Graphics Configuration

This section is used to configure the Network Stack settings.

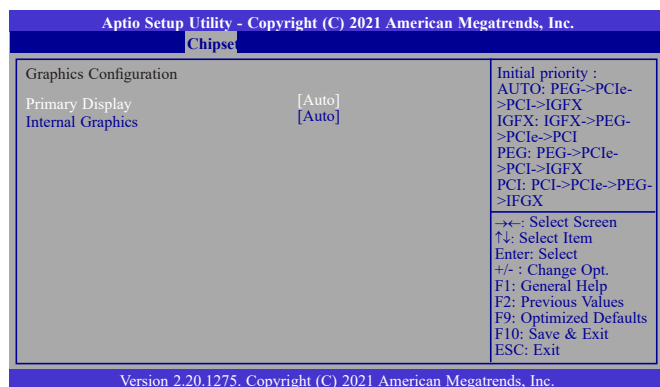

#### Primary Display

Select a Graphics device to be the primary display — Auto, IGFX, SG

Please choose SG for MXM vendor applications. (**Switchable Graphics = Optimus**)

#### Internal Graphics

Keep IGFX enabled based on the setup options.

## PEG Port Configuration

Configure the internal MXM3.1-B.

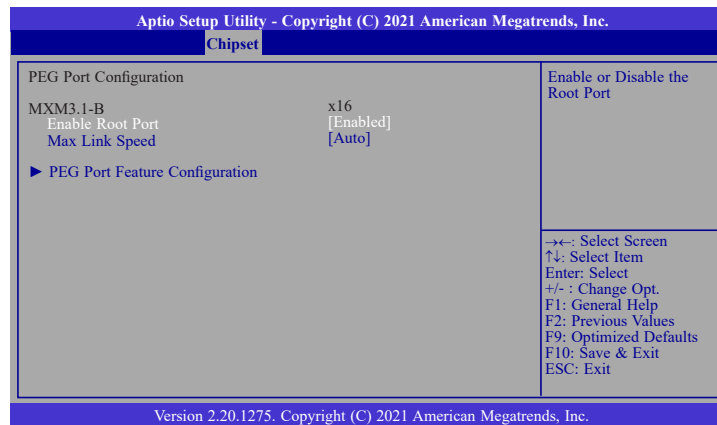

### Enable Root Port

Enable or disable the root port.

### Max Link Speed

Configure Max Link Speed: Auto, Gen1, Gen2 or Gen3.

## ► PEG Port Feature Configuration

This section configures the PEG port.

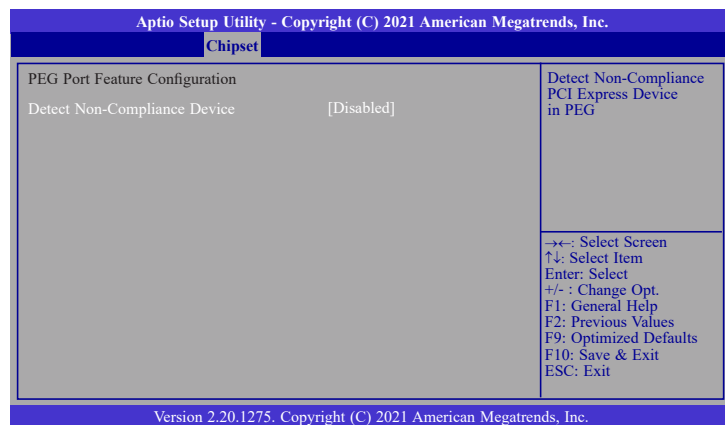

### Detect Non-Compliance Device

Enable or disable this field to detect non-compliance PCIe devices in the PEG.

## PCH-IO Configuration

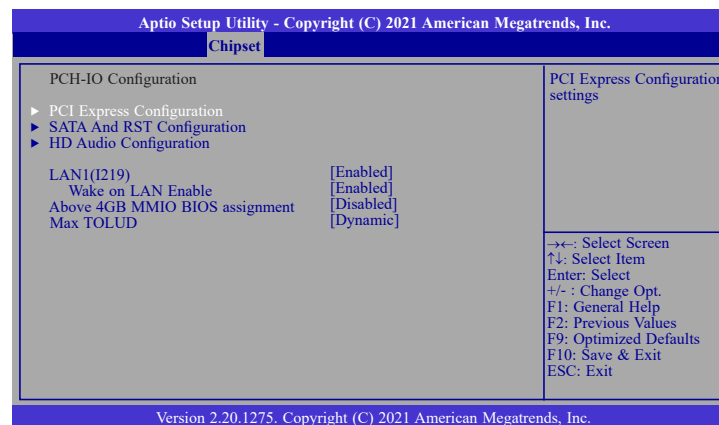

### ► PCI Express Configuration

Please refer to the following pages.

### ► SATA And RST Configuration

Please refer to the following pages.

### ► HD Audio Configuration

Please refer to the following pages.

### LAN1(I219)

Enable or disable onboard NIC.

### Wake on LAN Enable

Enable or disable integrated LAN to wake the system.

### Above 4GB MMIO BIOS assignment

Switch MemoryMappedIO BIOS assignment above 4GB.

### Max TOLUD

Assign a value or set "Dynamic" to automatically adjust TOLUD based on largest MMIO length.

## ► PCI Express Configuration

Select a PCIe root port.

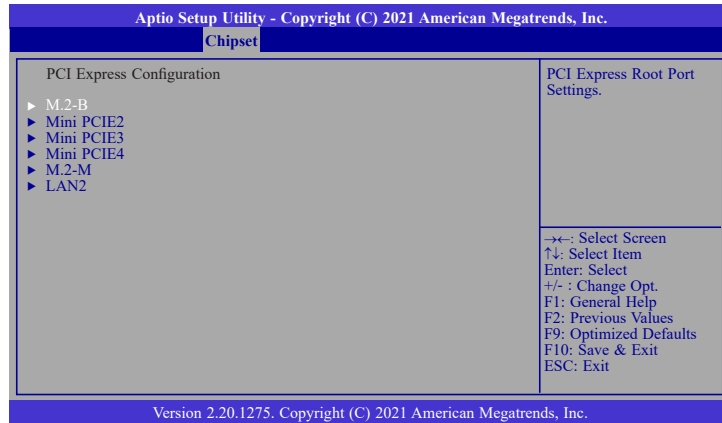

## ► PCI Express Configuration ► Devices

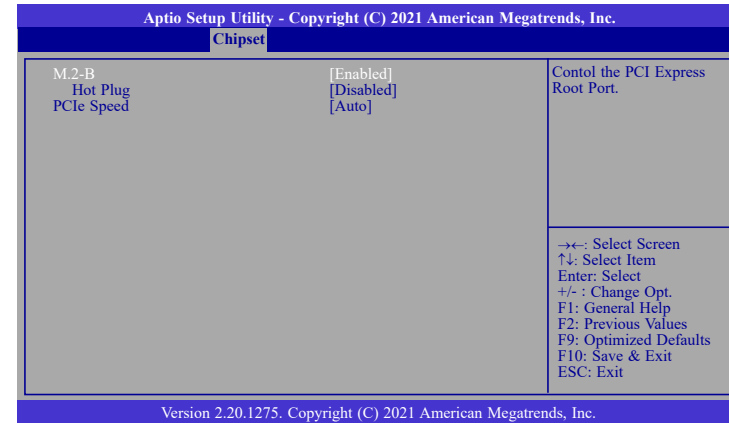

This field is used to enable or disable the PCI express root port.

### PCIe Speed

Select the speed of the PCI Express root port: Auto, Gen1, Gen 2 or Gen3. This field will not appear when the root port does not support speed configuration.

### Hot Plug

To enable or disable Hot Plug functions.

## ► SATA and RST Configuration

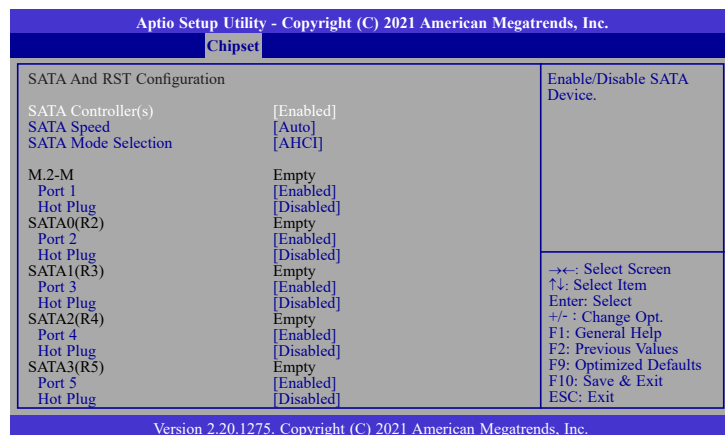

### SATA Controller(s)

Enable or disable the Serial ATA controller. When this field is enabled, the following fields will appear.

### SATA Speed

Select the speed of the Serial ATA controller: Auto, Gen1, Gen 2 or Gen3.

### SATA Mode Selection

The mode selection determines how the SATA controller(s) operates.

**AHCI** This option allows the Serial ATA controller(s) to use AHCI (Advanced Host Controller Interface).

### Intel RST Premium With Intel Optane System Acceleration

This option allows you to create RAID or Intel Rapid Storage configuration with Intel® Optane™ system acceleration on Serial ATA devices.

### Use RST Legacy OROM

This field is only available when SATA Mode Selection is set to "Intel RST Premium With Optane System Acceleration." It is used to enable or disable to use RST Legacy OROM.

### Serial ATA Ports

Enable or disable the Serial ATA port and its hot plug function.

## ► HD Audio Configuration

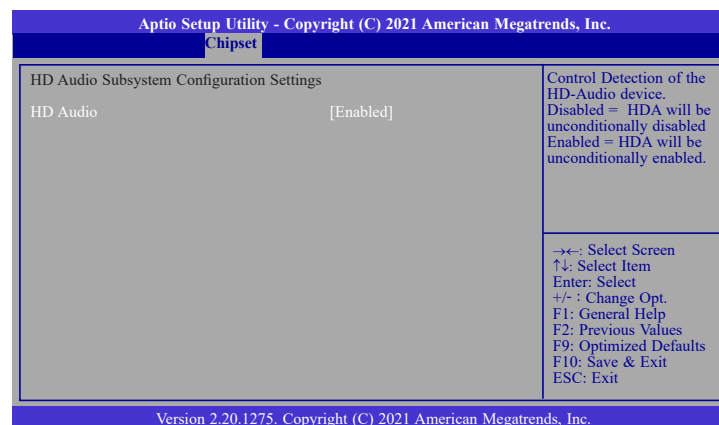

### HD Audio

Control the detection of the HD Audio device.

**Disabled** HDA will be unconditionally disabled.

**Enabled** HDA will be unconditionally enabled.

## Security

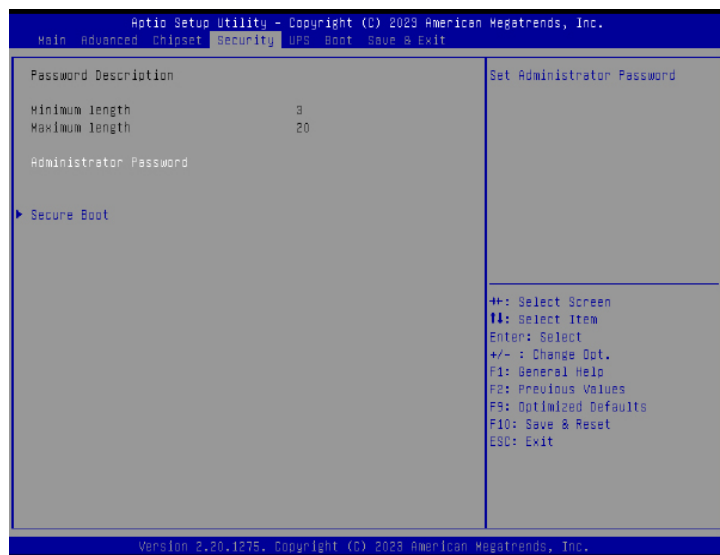

### Administrator Password

Set the administrator password. Input the password, press Enter, and then input the same character string again to confirm. To remove the password, input no character.

### Secure Boot

Secure Boot is used to verify that your boot loader is not tampered by malware.

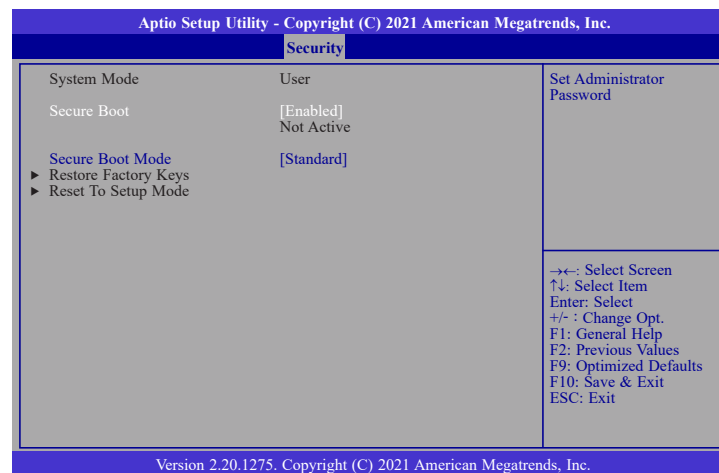

### System Mode

This field displays whether the system is in User or Setup mode.

### Secure Boot

Enable or disable Secure Boot. Please reset the platform after changing the setting.

### Restore Factory Keys

Force System to User Mode and install factory default Secure Boot key databases.

### Return to Setup Mode

This command is only available when the system mode is in User mode and Secure Boot Mode is set to Custom.

## UPS



## UPS

This page shows the information about UPS such as firmware version and battery remaining capacity.

## Boot

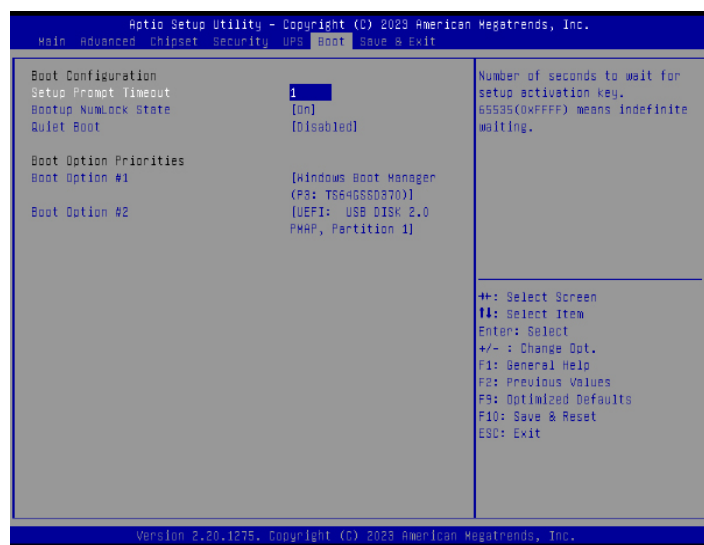

### Setup Prompt Timeout

Set the number of seconds to wait for the setup activation key. 65535 (0xFFFF) denotes indefinite waiting.

### Bootup NumLock State

Select the keyboard NumLock state: On or Off.

### Quiet Boot

This section is used to enable or disable quiet boot option.

### Boot Option Priorities

Select the system boot order.

### BGRT Logo

It is used to enable or disable to support display logo with ACPI BGRT table.

### Driver Option Priorities

Select the driver boot order.

## Save & Exit

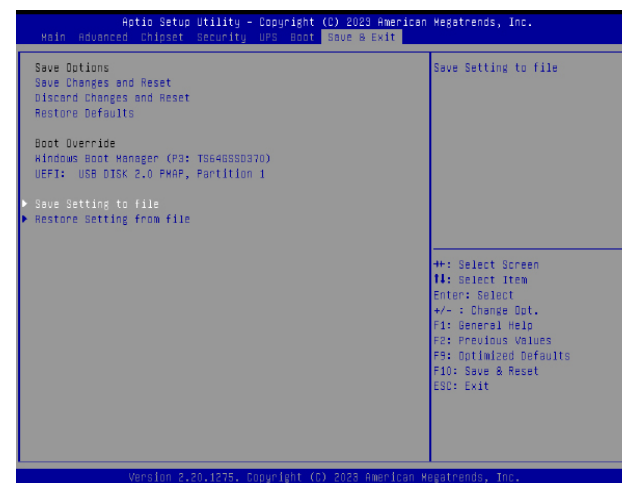

### Save Changes and Reset

To save the changes, select this field and then press <Enter>. A dialog box will appear. Select Yes to reset the system after saving all changes made.

### Discard Changes and Reset

To discard the changes, select this field and then press <Enter>. A dialog box will appear. Select Yes to reset the system setup without saving any changes.

### Restore Defaults

To restore and load the optimized default values, select this field and then press <Enter>. A dialog box will appear. Select Yes to restore the default values.

### Boot Override

Move the cursor to an available boot device and press Enter, the system will immediately boot from the boot device. This function will only be effective for the current boot. The "Boot Option Priorities" in the Boot menu will not be changed.

### Save Setting to file

Select this option to save BIOS configuration settings to a USB flash device.

### Restore Setting from file

This field will appear only when a USB flash device is detected. Select this field to restore setting from the USB flash device.

## Updating the BIOS

To update the BIOS, you will need the new BIOS file and a flash utility. Please contact technical support or your sales representative for the files. You may refer to the how-to video "How to update AMI BIOS in UEFI mode on DFI products?" at <https://www.dfi.com/Knowledge/Video/5> for updating the BIOS steps.

## Notice: BIOS SPI ROM

1. The Intel® Management Engine has already been integrated into this system board. Due to the safety concerns, the BIOS (SPI ROM) chip cannot be removed from this system board and used on another system board of the same model.
2. The BIOS (SPI ROM) on this system board must be the original equipment from the factory and cannot be used to replace one which has been utilized on other system boards.
3. If you do not follow the methods above, the Intel® Management Engine will not be updated and will cease to be effective.



### Note:

- a. You can take advantage of flash tools to update the default configuration of the BIOS (SPI ROM) to the latest version anytime.
- b. When the BIOS IC needs to be replaced, you have to populate it properly onto the system board after the EEPROM programmer has been burned and follow the technical person's instructions to confirm that the MAC address should be burned or not.