



# **WM343-MB**

## **Desktop Box IPC**

### **User's Manual**

## Copyright

This publication contains information that is protected by copyright. No part of it may be reproduced in any form or by any means or used to make any transformation/adaptation without the prior written permission from the copyright holders.

This publication is provided for informational purposes only. The manufacturer makes no representations or warranties with respect to the contents or use of this manual and specifically disclaims any express or implied warranties of merchantability or fitness for any particular purpose. The user will assume the entire risk of the use or the results of the use of this document. Further, the manufacturer reserves the right to revise this publication and make changes to its contents at any time, without obligation to notify any person or entity of such revisions or changes.

Changes after the publication's first release will be based on the product's revision. The website will always provide the most updated information.

© 2016. All Rights Reserved.

## Trademarks

Product names or trademarks appearing in this manual are for identification purpose only and are the properties of the respective owners.

## FCC and DOC Statement on Class A

This equipment has been tested and found to comply with the limits for a Class A digital device, pursuant to Part 15 of the FCC rules. These limits are designed to provide reasonable protection against harmful interference when the equipment is operated in a residential installation. This equipment generates, uses and can radiate radio frequency energy and, if not installed and used in accordance with the instruction manual, may cause harmful interference to radio communications. However, there is no guarantee that interference will not occur in a particular installation. If this equipment does cause harmful interference to radio or television reception, which can be determined by turning the equipment off and on, the user is encouraged to try to correct the interference by one or more of the following measures:

- Reorient or relocate the receiving antenna.
- Increase the separation between the equipment and the receiver.
- Connect the equipment into an outlet on a circuit different from that to which the receiver is connected.
- Consult the dealer or an experienced radio TV technician for help.

### Notice:

1. The changes or modifications not expressly approved by the party responsible for compliance could void the user's authority to operate the equipment.
2. Shielded interface cables must be used in order to comply with the emission limits.

# Table of Contents

Copyright.....	2
Trademarks.....	2
FCC and DOC Statement on Class A.....	2
About this Manual .....	4
Warranty .....	4
Static Electricity Precautions.....	4
Safety Measures.....	4
Safety Precautions.....	5
About the Package .....	5
Before Using the System .....	5
Chapter 1 - Introduction.....	6
Overview.....	6
Specifications.....	7
Getting to Know the WM343-MB.....	8
Chapter 2 - Getting Started.....	12
Chapter 3 - Installing Devices.....	13
Chapter 4 - Jumper Settings .....	17
Jumper Settings (MB330-CRM).....	17
Clear CMOS Data (MB330-CRM).....	17
PS/2 Keyboard/Mouse Power Select (MB330-CRM).....	17
USB Power Select (MB330-CRM).....	18
Power-on Select (MB330-CRM).....	18
COM1/COM2 RS232/RS422/RS485 Select (MB330-CRM).....	19
COM1/COM2 RS232/Power Select (MB330-CRM).....	19
Jumper Settings (MB331-CRM).....	20
Clear CMOS Data (MB331-CRM).....	20
PS/2 Keyboard/Mouse Power Select (MB331-CRM).....	20
USB Power Select (MB331-CRM).....	21

Power-on Select (MB331-CRM).....	21
COM1/COM2 RS232/RS422/RS485 Select (MB331-CRM).....	22
COM1/COM2 RS232/Power Select (MB331-CRM).....	22

## Chapter 5 - Ports and Connectors .....23

Rear Panel I/O Ports (MB330-CRM).....	23
I/O Connectors (MB330-CRM).....	27
Rear Panel I/O Ports (MB331-CRM).....	34
I/O Connectors (MB331-CRM).....	38

## Chapter 6 - Mounting Options.....44

## Chapter 7 - BIOS Setup 46

Overview .....	46
AMI BIOS Setup Utility (MB330-CRM).....	47
Main.....	47
Advanced .....	47
Chipset .....	57
Boot .....	62
Security .....	64
Save & Exit .....	65
AMI BIOS Setup Utility (MB331-CRM).....	66
Main.....	66
Advanced .....	66
Boot.....	80
Security .....	81
Save & Exit .....	82
Updating the BIOS.....	83
Notice: BIOS SPI ROM.....	83

## Chapter 8 - Supported Software.....84

## Chapter 9 - Intel AMT Settings.....95

## Appendix A - Troubleshooting Checklist..... 109

## About this Manual

An electronic file of this manual can be obtained from the DFI website at [www.dfi.com](http://www.dfi.com). To download the user's manual from our website, please go to "Support" > "Download Center." On the Download Center page, select your product or type the model name and click "Search" to find all technical documents including the user's manual for a specific product.

## Warranty

1. Warranty does not cover damages or failures that arised from misuse of the product, inability to use the product, unauthorized replacement or alteration of components and product specifications.
2. The warranty is void if the product has been subjected to physical abuse, improper installation, modification, accidents or unauthorized repair of the product.
3. Unless otherwise instructed in this user's manual, the user may not, under any circumstances, attempt to perform service, adjustments or repairs on the product, whether in or out of warranty. It must be returned to the purchase point, factory or authorized service agency for all such work.
4. We will not be liable for any indirect, special, incidental or consequential damages to the product that has been modified or altered.

## Static Electricity Precautions

It is quite easy to inadvertently damage your PC, system board, components or devices even before installing them in your system unit. Static electrical discharge can damage computer components without causing any signs of physical damage. You must take extra care in handling them to ensure against electrostatic build-up.

1. To prevent electrostatic build-up, leave the system board in its anti-static bag until you are ready to install it.
2. Wear an antistatic wrist strap.
3. Do all preparation work on a static-free surface.
4. Hold the device only by its edges. Be careful not to touch any of the components, contacts or connections.
5. Avoid touching the pins or contacts on all modules and connectors. Hold modules or connectors by their ends.



### Important:

Electrostatic discharge (ESD) can damage your processor, disk drive and other components. Perform the upgrade instruction procedures described at an ESD workstation only. If such a station is not available, you can provide some ESD protection by wearing an antistatic wrist strap and attaching it to a metal part of the system chassis. If a wrist strap is unavailable, establish and maintain contact with the system chassis throughout any procedures requiring ESD protection.

## Safety Measures

To avoid damage to the system:

- Use the correct AC input voltage range.

To reduce the risk of electric shock:

- Unplug the power cord before removing the system chassis cover for installation or servicing. After installation or servicing, cover the system chassis before plugging the power cord.

Battery:

- Danger of explosion if battery incorrectly replaced.
- Replace only with the same or equivalent type recommend by the manufacturer.
- Dispose of used batteries according to local ordinance.



## Safety Precautions

- Use the correct DC input voltage range.
- Unplug the power cord before removing the system chassis cover for installation or servicing. After installation or servicing, cover the system chassis before plugging the power cord.
- Danger of explosion if battery incorrectly replaced.
- Replace only with the same or equivalent type recommend by the manufacturer.
- Dispose of used batteries according to local ordinance.
- Keep this system away from humidity.
- Place the system on a stable surface. Dropping it or letting it fall may cause damage.
- The openings on the system are for air ventilation to protect the system from overheating. **DO NOT COVER THE OPENINGS.**
- Place the power cord in such a way that it will not be stepped on. Do not place anything on top of the power cord. Use a power cord that has been approved for use with the system and that it matches the voltage and current marked on the system's electrical range label.
- If the system will not be used for a long time, disconnect it from the power source to avoid damage by transient overvoltage.
- If one of the following occurs, consult a service personnel:
  - The power cord or plug is damaged.
  - Liquid has penetrated the system.
  - The system has been exposed to moisture.
  - The system is not working properly.
  - The system dropped or is damaged.
  - The system has obvious signs of breakage.
- The unit uses a three-wire ground cable which is equipped with a third pin to ground the unit and prevent electric shock. Do not defeat the purpose of this pin. If your outlet does not support this kind of plug, contact your electrician to replace the outlet.
- Disconnect the system from the DC outlet before cleaning. Use a damp cloth. Do not use liquid or spray detergents for cleaning.

## About the Package

The package contains the following items. If any of these items are missing or damaged, please contact your dealer or sales representative for assistance.

- 1 WM343-MB System Unit
- 1 CPU cooler
- 1 SATA Data Cable (Length: 650mm)
- 4 HDD Screws
- 1 Quick Installation Guide
- 1 250W PSU
- 1 System Fan

## Optional Items

- Power Cord

The board and accessories in the package may not come similar to the information listed above. This may differ in accordance to the sales region or models in which it was sold. For more information about the standard package in your region, please contact your dealer or sales representative.

## Before Using the System

Before powering-on the system, prepare the basic system components.

If you are installing the system board in a new system, you will need at least the following internal components.

- Memory module
- Storage devices such as hard disk drive, CD-ROM, etc.

You will also need external system peripherals you intend to use which will normally include at least a keyboard, a mouse and a video display monitor.

## Chapter 1 - Introduction

### Overview



Front View



Rear View (MB330-CRM)



Rear View (MB331-CRM)

### Key Features

<b>Model Name</b>	<b>WM343-MB</b>
<b>Processor</b>	3rd/2nd Generation Intel® Core™ processors
<b>Chipset</b>	Intel® Q77 Express chipset
<b>LAN</b>	2 LAN ports
<b>COM</b>	1 COM port (MB330-CRM, plus 2 optional) 2 COM ports (MB331-CRM, plus 2 optional)
<b>Displays</b>	MB330-CRM: 2 DVI-I (top: DVI-D signal), 1 HDMI MB331-CRM: 1 VGA, 1 DVI-I (DVI-D signal)
<b>USB</b>	MB330-CRM: 4 USB 3.0 ports + 2 USB 2.0 ports MB331-CRM: 4 USB 3.0 ports
<b>Audio</b>	Mic-in, Line-in, Line-out

## Specifications

<b>System</b>	Processor	LGA 1155 Socket 3rd Generation Intel® Core™ Processors Intel® Core™ i7-3770, 8M Cache, 3.4GHz (3.9GHz), 77W Intel® Core™ i5-3550S, 6M Cache, 3GHz (3.7GHz), 65W Intel® Core™ i3-3220, 3M Cache, 3.3GHz, 55W Intel® Pentium® G2120, 3M Cache, 3.1GHz, 55W Intel® Celeron® G1620, 2M Cache, 2.7GHz, 55W 2nd Generation Intel® Core™ Processors Intel® Core™ i7-2600, 8M Cache, 3.4GHz (3.8GHz), 95W Intel® Core™ i5-2400, 6M Cache, 3.1GHz (3.4GHz), 95W Intel® Core™ i3-2120, 3M Cache, 3.3GHz, 65W Intel® Pentium® G850, 3M Cache, 2.9GHz, 65W
	Chipset	Intel® Q77 Express Chipset
	Memory	Four 240-pin DIMM up to 32GB Dual Channel DDR3 1333/1600MHz (3rd gen processors) Dual Channel DDR3 1066/1333MHz (2nd gen processors)
	BIOS	AMI SPI 64Mbit
<b>Graphics</b>	Controller	Intel® HD Graphics 4000 (Core i7) Intel® HD Graphics 2500 (Core i5/i3/Pentium)
	Feature	Direct X 11, OGL 3.0
	Display	MB330-CRM: 1 x DVI-I (DVI-D signal) 1 x DVI-I 1 x HDMI MB331-CRM: 1 x VGA 1 x DVI-I (DVI-D signal) DVI, HDMI: resolution up to 1920x1200 @ 60Hz VGA: resolution up to 2048x1536 @ 75Hz, 32-bit
	Triple/Quad Displays	MB330-CRM: DVI-I + DVI-I + HDMI MB331-CRM: VGA + DVI-I
<b>Storage</b>	External	1 or 2 x 3.5"/2.5" SATA 3.0 Drive Bays (1 x 3.5" SATA drive bay, by default) 1 x 5.25" Optical Drive Bay
<b>Expansion</b>	Interface	1 x PCIe x16 (3rd gen processors support Gen 3) (2nd gen processors support Gen 2) 1 x PCIe x4 (Gen 2) 2 x PCI (PCI 2.3) 1 x Full-size Mini PCIe (PCIe/USB) (MB330-CRM only)
	Audio	Codec Realtek ALC886 5.1-channel

<b>ETHERNET</b>	Controller	1 x Intel® WG82574L PCIe (10/100/1000Mbps) 1 x Intel® WG82579LM PCIe with iAMT8.0 (10/100/1000Mbps)
<b>LED</b>	Indicators	1 x Power LED 1 x HDD LED
<b>REAR I/O</b>	Ethernet	2 x GbE (RJ-45)
	Serial	MB330-CRM: 1 x RS-232/422/485 (DB-9) 2 x RS-232 (DB-9) (available upon request) MB331-CRM: 2 x RS-232/422/485 (DB-9) 2 x RS-232 (DB-9) (available upon request)
	USB	MB330-CRM: 4 x USB 3.0 + 2 x USB 2.0 4 x USB 2.0 (available upon request) 4 x USB 2.0 (available upon request) 4 x USB 3.0 (available upon request) MB331-CRM: 4 x USB 3.0 + 6 x USB 2.0 4 x USB 2.0 (available upon request)
	PS/2	MB330-CRM: 1 x PS/2 (mini-DIN-6) MB331-CRM: 2 x PS/2 (mini-DIN-6)
	Display	MB330-CRM: 1 x DVI-I 1 x DVI-I (DVI-D signal) 1 x HDMI MB331-CRM: 1 x VGA 1 x DVI-I (DVI-D signal)
	Audio	1 x Line-out 1 x Line-in 1 x Mic-in
	Buttons	1 x Power Button
<b>Cooling</b>	Fan	1 x System Fan
<b>WatchDog Timer</b>	Output & Interval	System Reset, Programmable via Software from 1 to 255 Seconds
<b>Power</b>	Supply	Flex ATX 250W
<b>OS Support</b>		WES7, Windows 8
<b>Mechanical</b>	Construction	Sheet Metal
	Compliance	Wall Mount
	Dimensions	349mm x 140mm x 300mm (13.74" x 5.51" x 11.81") (W x H x D)
	Weight	TBD

<b>Environment</b>	Operating Temperature	0 to 45°C
	Storage Temperature	0 to 60°C
	Relative Humidity	5 to 95% RH (non-condensing)
<b>Mechanical</b>	Shock	Operating: 3G Non-operating: 5G
	Vibration	Operating: Random 5~500Hz 0.5G Non-operating: Sine 10~500Hz 1.5G
	Package Drop	ISTA Project 1A
	Certification	CE, FCC Class A, RoHS

## Getting to Know the WM343-MB

### Front View

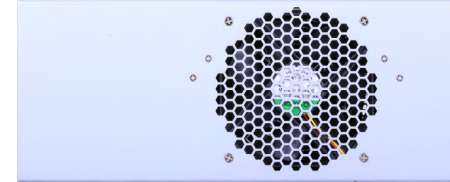

### Rear View (MB330-CRM)

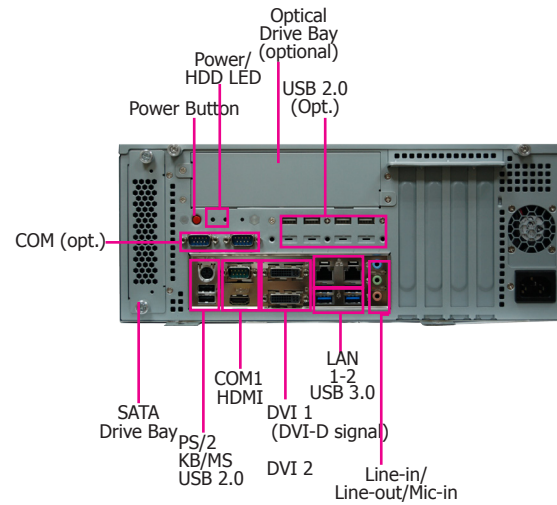

#### DVI-I Port

Used to connect a DVI device.

#### HDMI

Used to connect an HDMI device.

#### COM Ports

Used to connect serial devices.

#### USB Ports

Used to connect USB 3.0/2.0/1.1 devices.

#### LAN Ports

Used to connect the system to a local area network.

#### Line-out

Used to connect to a speaker.

#### Line-in

Used to connect any audio devices such as Hi-fi set, CD player, tape player, AM/FM radio tuner, synthesizer, etc.

#### Mic-in

Used to connect an external microphone.

#### PS/2 KB/Mouse

Used to connect a PS/2 keyboard and PS/2 mouse.

#### Expansion slots

Supports to add riser cards.

#### Power Button

Press to power-on or power-off the system.

#### HDD LED

Indicates the status of the hard drive.

#### Power LED

Indicates the power status of the system.

#### SATA Drive Bay

Used to insert a SATA drive.

#### Optical Drive Bay

Used to insert a DVD or CD-ROM.

### Rear View (MB331-CRM)

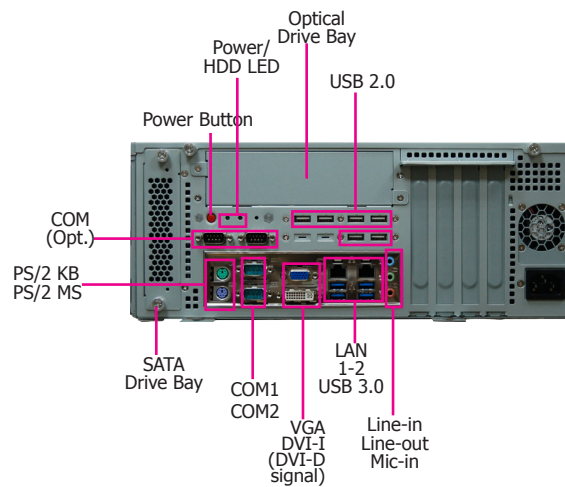

### Mechanical Dimensions (MB330-CRM)

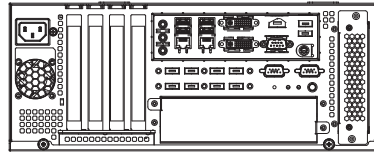

Rear View

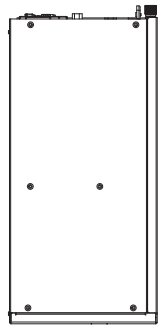

Left View

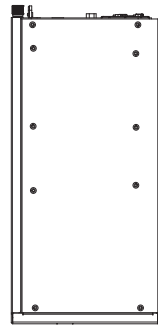
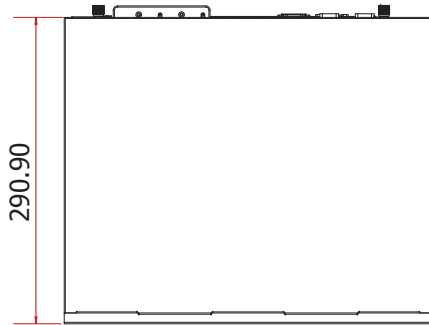

Right View

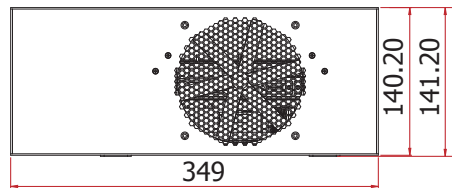

Front View

### Mechanical Dimensions (MB331-CRM)

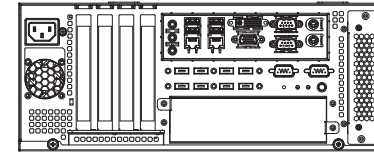

Rear View

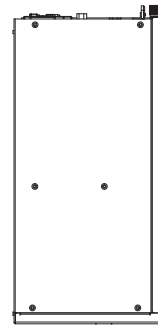
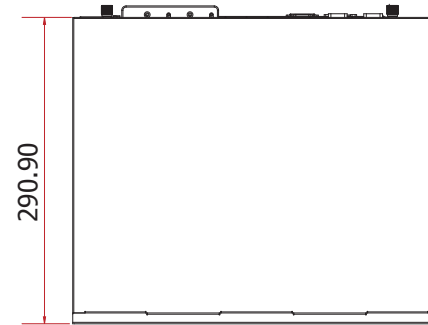

Left View

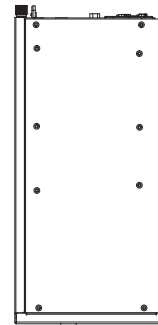

Right View

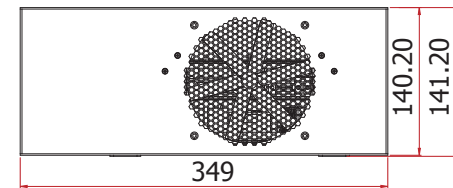

Front View

Motherboard Dimensions (MB330-CRM)

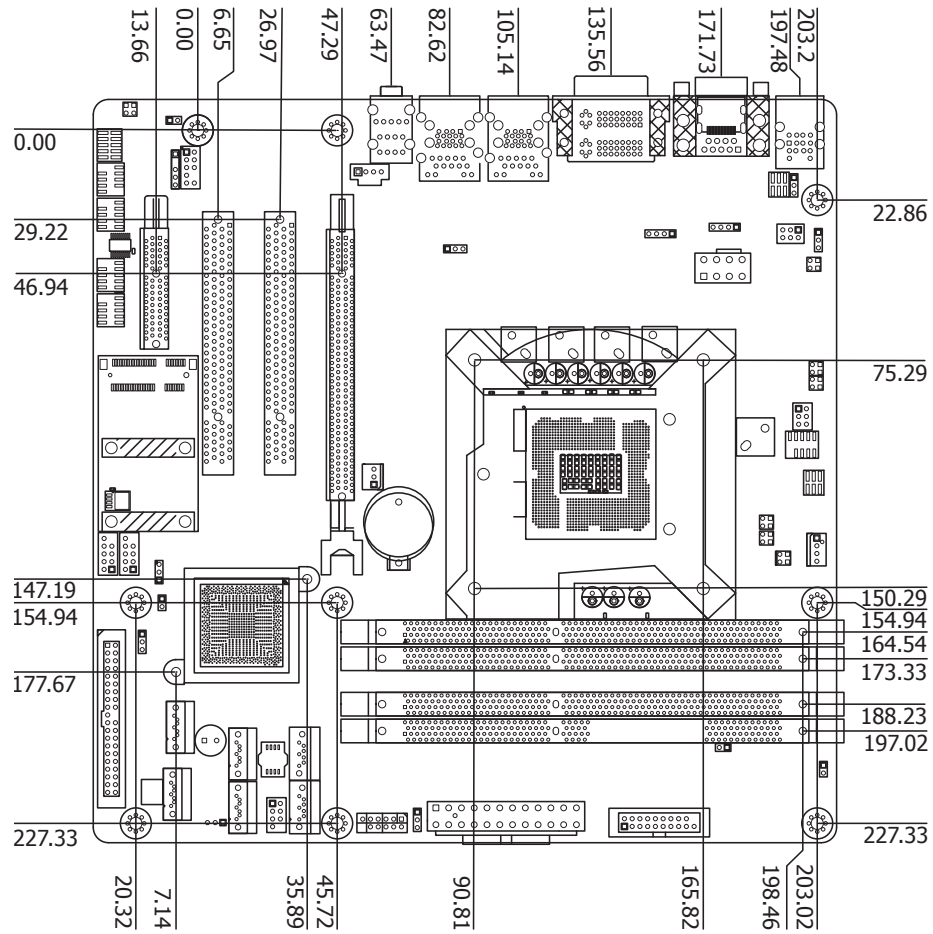

Motherboard Dimensions (MB331-CRM)

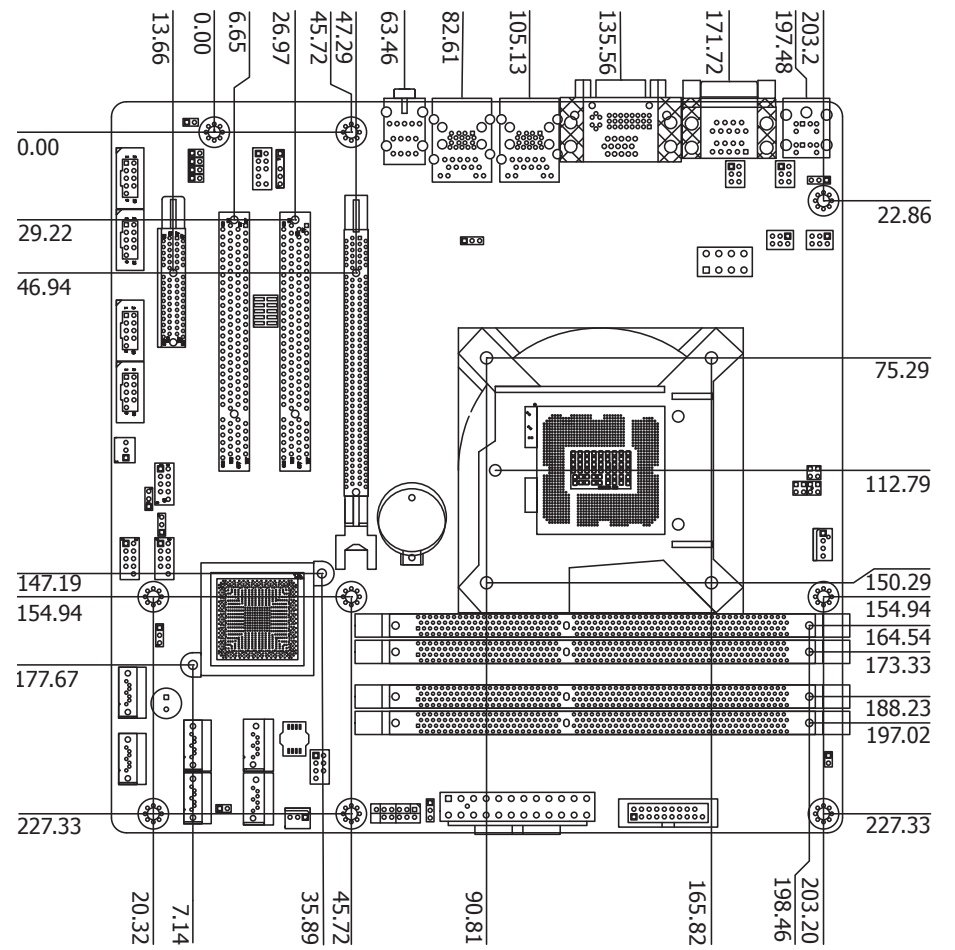

## Chapter 2 - Getting Started

---

### Preparing the System

Before you start using the system, you need the following items:

- SATA hard drive
- AC power adapter
- PS/2 or USB keyboard
- PS/2 or USB mouse
- CD-ROM drive (for installing software/drivers)
- Screwdriver
- Memory module (optional)

### Installing Devices

The following are devices that can be installed in the system.

- Memory module
- SATA hard drive

### Configuring the BIOS

To get you started, you may need to change configurations such as the date, time and the type of hard disk drive.

1. Power-on the system.
2. After the memory test, the message "Press DEL to run setup" will appear on the screen. Press the Delete key to enter the AMI BIOS setup utility.

### Installing the Operating System

Most operating system software can be installed using a DVD (and DVD burner) or bootable USB drive.

Please refer to your operating system manual for instructions on installing an operating system.

### Installing the Drivers

The system requires you to install drivers for some devices to operate properly. Refer to the Supported Software chapter for instructions on installing the drivers.



## Chapter 3 - Installing Devices

### Opening the Chassis

1. Make sure the system and all other peripheral devices connected to it has been powered-off.
2. Disconnect all power cords and cables.
3. Remove the top cover by uninstalling the thumb screws.
4. slide the cover backwards.

Thumb screws



Thumb screws

Slide the Cover backward



5. Remove the CD tray.

CD tray screws

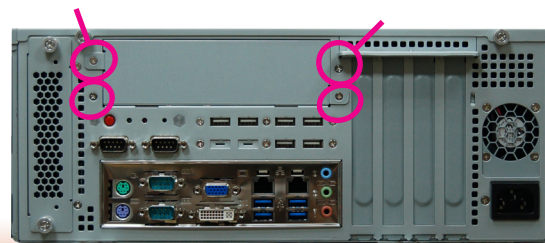

CD tray screws

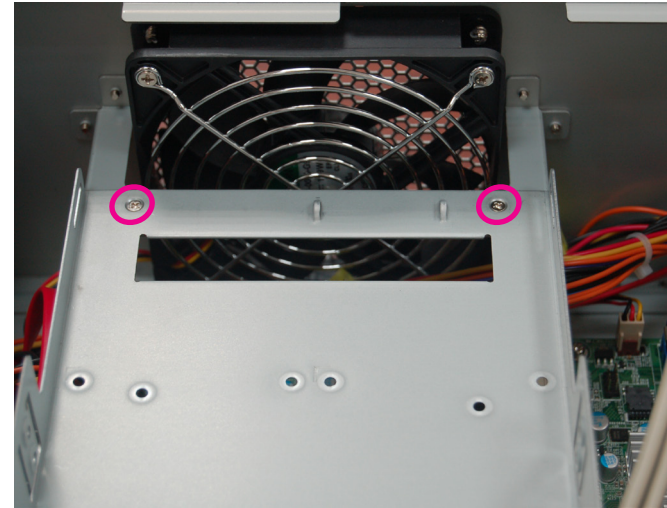

5. The DIMM sockets are readily accessible after removing the chassis cover.

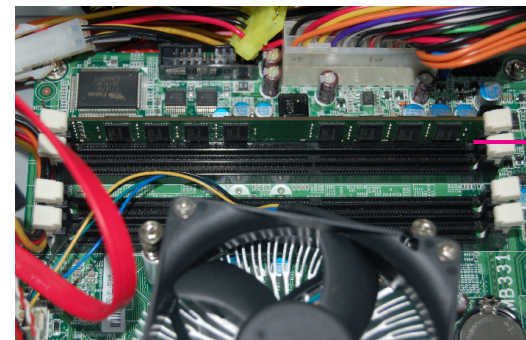

DIMM socket

## Installing a 2.5" or 3.5" SATA Drive

1. Remove the thumb screws that secure the drive bay to the chassis and then remove the drive bay.



## Installing a 2.5" SATA Drive



## Installing a 3.5" SATA Drive

2. Secure the hard drive to the drive bay. Use 4 mounting screws to install the hard drive onto the drive bay.

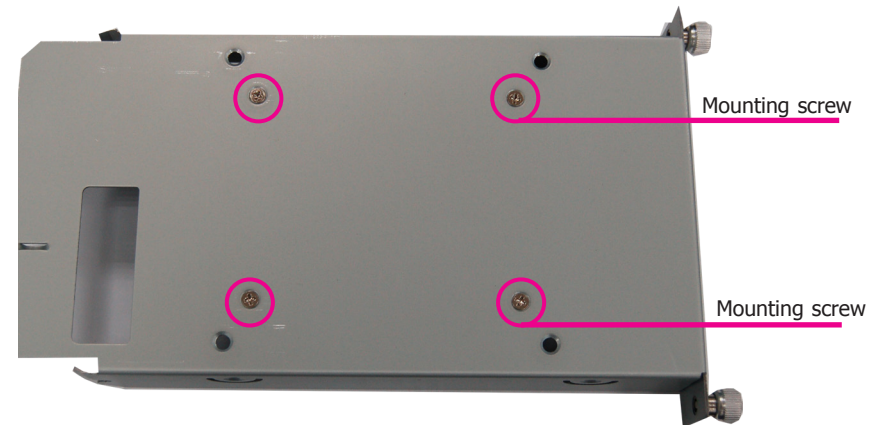

3. Slide the HDD drive back to the system.
4. Connect the SATA data cable and SATA power cable to the connectors on the SATA drive.





## Installing a PCI or PCIe Expansion Card

1. To install the expansion card, you need to remove the mounting bracket and the mounting screw that secure the bracket to the chassis. Put the screw and the brackets in a safe place for later use.

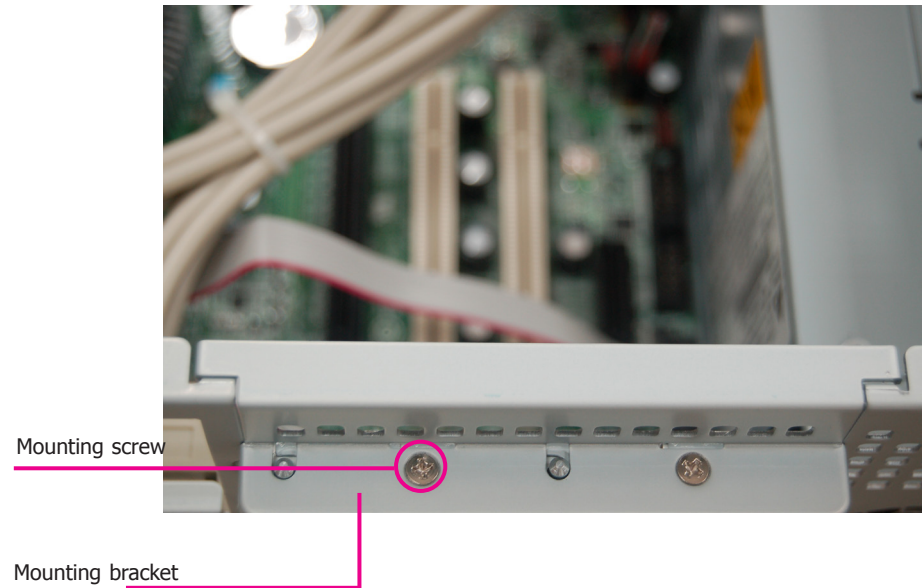

2. Insert the Expansion card into the PCI or PCIe slot. Replace the screw you removed in step 1 to secure the bracket in place.

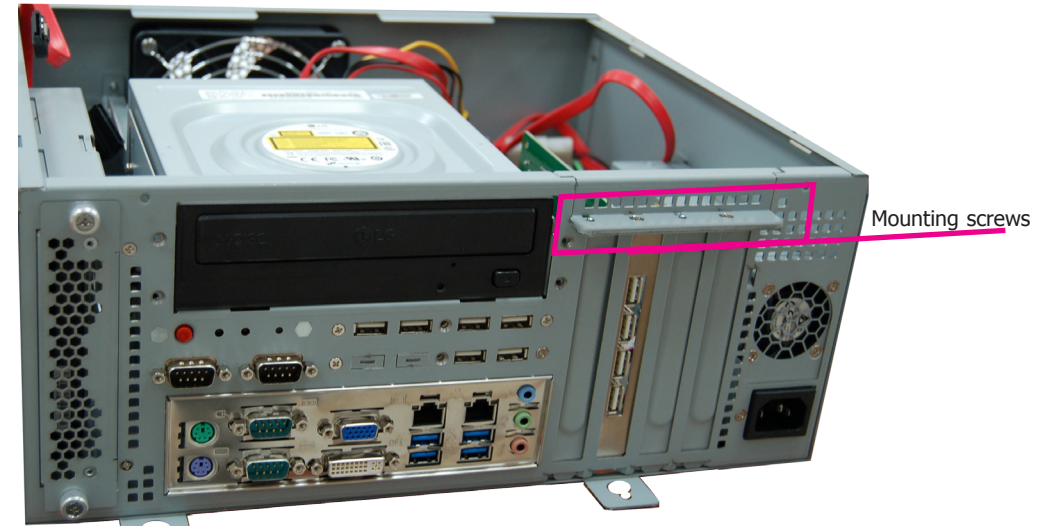
**Note:**

The Expansion card used in the above illustrations may not resemble the actual cards. These illustrations are for reference only.

## Chapter 4 - Jumper Settings

### Jumper Settings (MB330-CRM)

#### Clear CMOS Data (MB330-CRM)

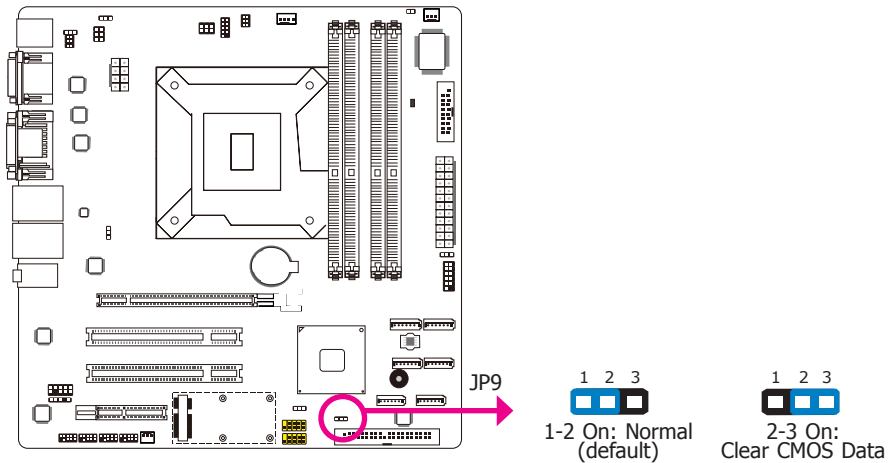

If you encounter the following,

- CMOS data becomes corrupted.
- You forgot the supervisor or user password.

you can reconfigure the system with the default values stored in the ROM BIOS.

To load the default values stored in the ROM BIOS, please follow the steps below.

- Power-off the system and unplug the power cord.
- Set JP9 pins 2 and 3 to On. Wait for a few seconds and set JP9 back to its default setting, pins 1 and 2 On.
- Now plug the power cord and power-on the system.

#### PS/2 Keyboard/Mouse Power Select (MB330-CRM)

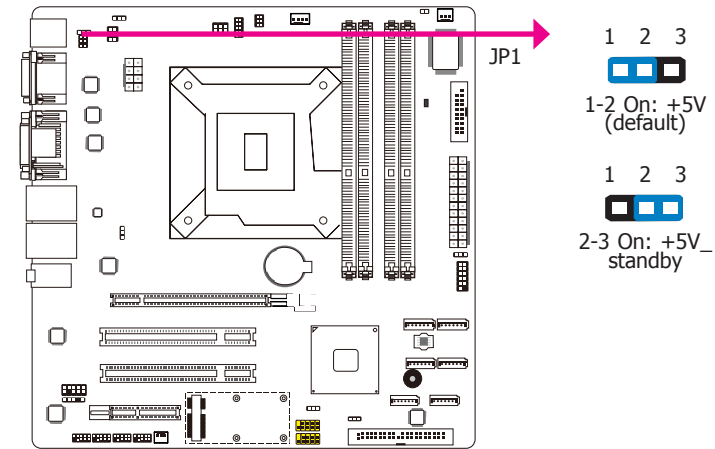

JP1 is used to select the power of the PS/2 keyboard and PS/2 mouse ports. Selecting +5V\_ standby will allow you to use the PS/2 keyboard or PS/2 mouse to wake up the system.



#### Important:

The +5VSB power source of your power supply must support  $\geq 720\text{mA}$ .

## USB Power Select (MB330-CRM)

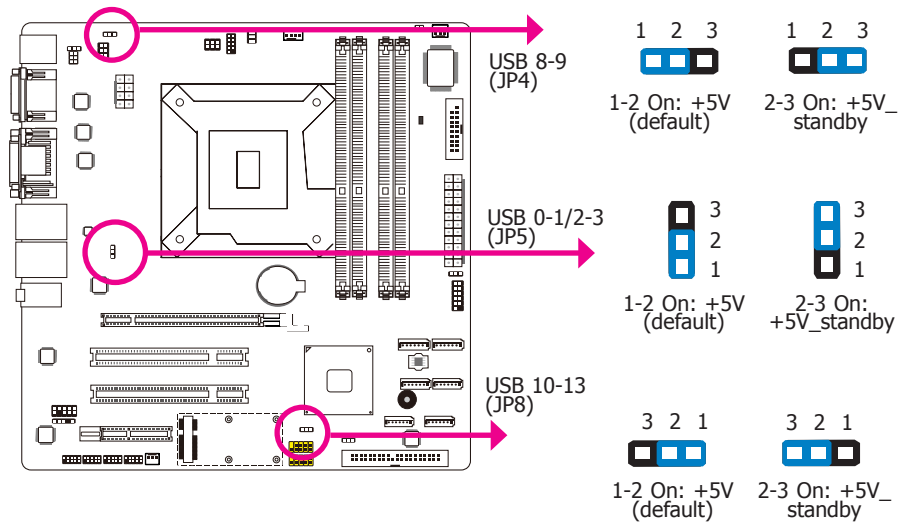

These jumpers are used to select the power of the USB ports. Selecting +5V\_standby will allow you to use a USB device to wake up the system.



### Important:

If you are using the Wake-On-USB Keyboard/Mouse function for 2 USB ports, the +5V\_standby power source of your power supply must support  $\geq 1.5A$ . For 3 or more USB ports, the +5V\_standby power source of your power supply must support  $\geq 2A$ .

## Power-on Select (MB330-CRM)

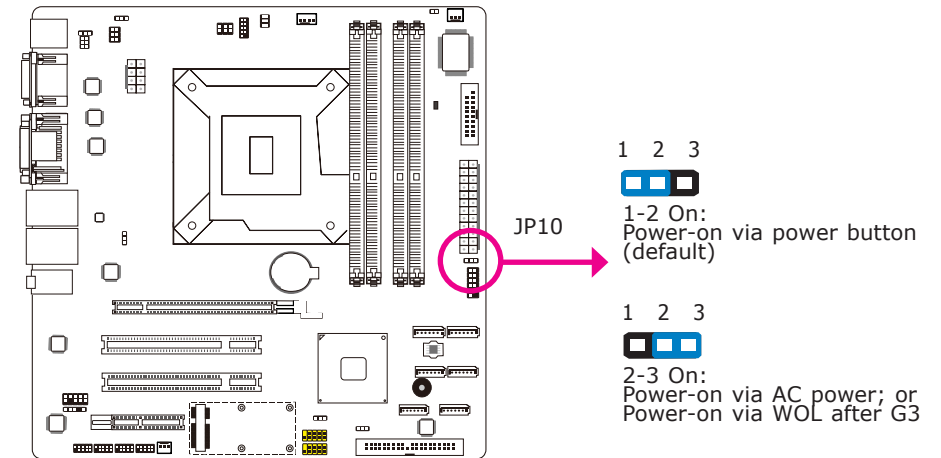

To power-on via WOL after G3:

1. Set JP10 pins 2 and 3 to On.
2. Set the "After G3" field to Power Off/WOL.
3. Set the "GbE Wake Up From S5" to Enabled.

The BIOS fields are in the "South Bridge Configuration" submenu (Chipset menu) of the AMI BIOS utility.

To power-on via AC Power:

1. Set JP10 pins 2 and 3 to On.
2. Set the "After G3" field to Power On.

### COM1/COM2 RS232/RS422/RS485 Select (MB330-CRM)

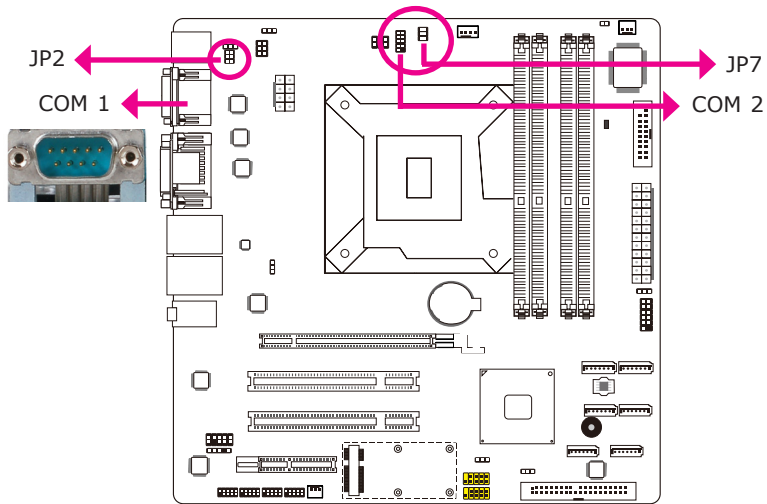

JP2 (for COM1) and JP7 (for COM2) are used to configure the COM ports to RS232, RS422 (Full Duplex) or RS485.

The pin function of the COM ports will vary according to the jumper settings.

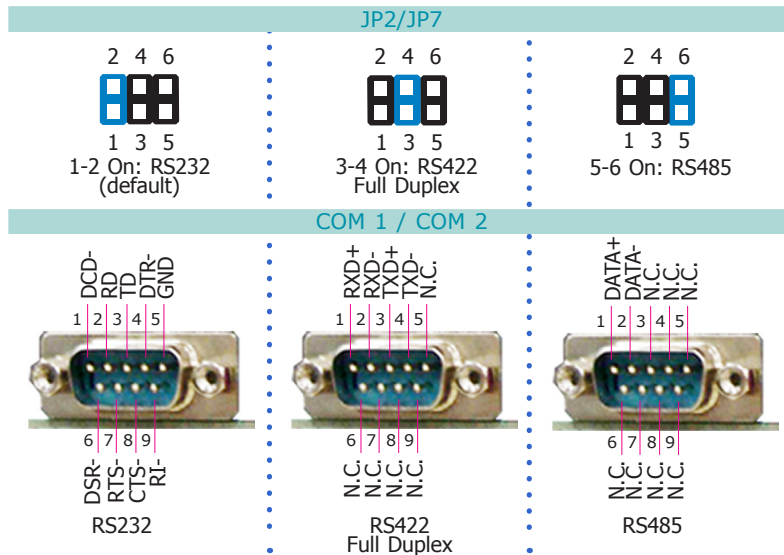

### COM1/COM2 RS232/Power Select (MB330-CRM)

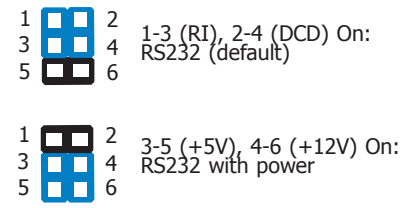
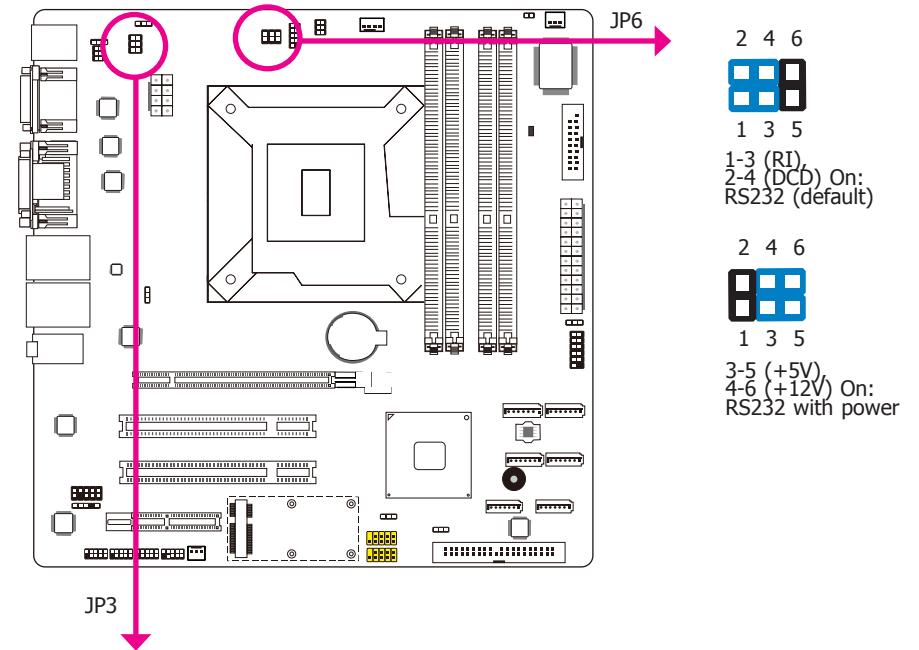

## Jumper Settings (MB331-CRM)

### Clear CMOS Data (MB331-CRM)

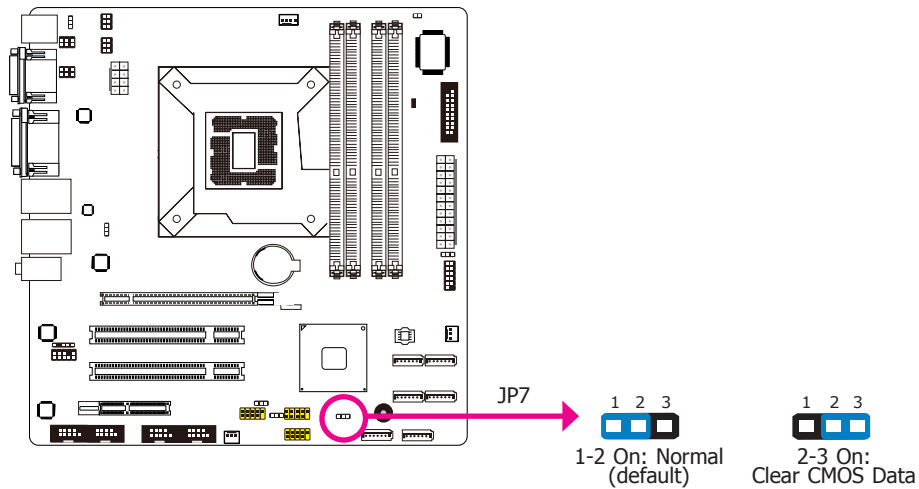

If you encounter the following,

- CMOS data becomes corrupted.
- You forgot the supervisor or user password.

you can reconfigure the system with the default values stored in the ROM BIOS.

To load the default values stored in the ROM BIOS, please follow the steps below.

- Power-off the system and unplug the power cord.
- Set JP7 pins 2 and 3 to On. Wait for a few seconds and set JP7 back to its default setting, pins 1 and 2 On.
- Now plug the power cord and power-on the system.

### PS/2 Keyboard/Mouse Power Select (MB331-CRM)

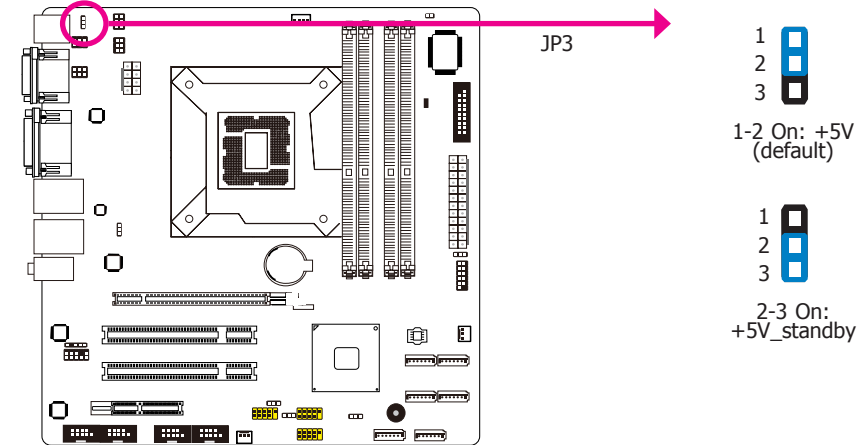

JP3 is used to select the power of the PS/2 keyboard and PS/2 mouse ports. Selecting +5V\_standby will allow you to use the PS/2 keyboard or PS/2 mouse to wake up the system.



#### Important:

The +5VSB power source of your power supply must support  $\geq 720\text{mA}$ .



## USB Power Select (MB331-CRM)

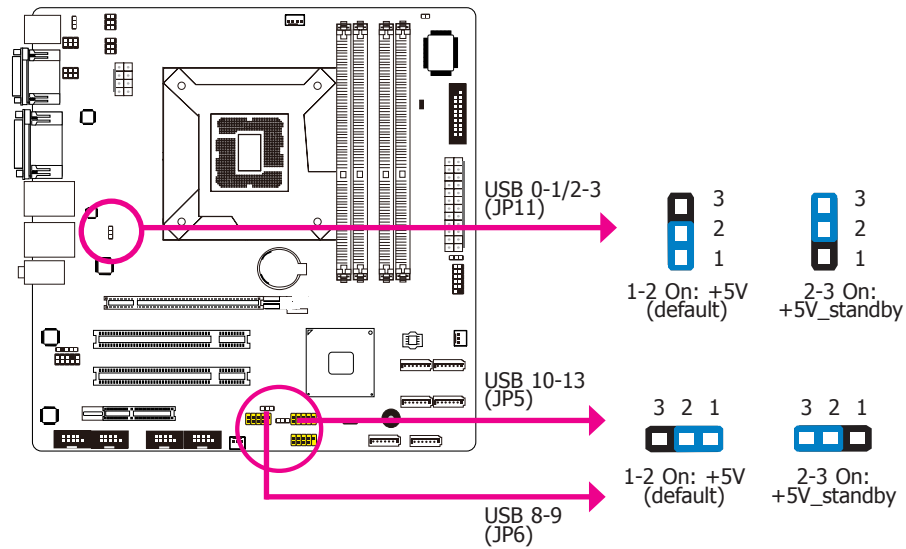

These jumpers are used to select the power of the USB ports. Selecting +5V\_standby will allow you to use a USB device to wake up the system.



### Important:

If you are using the Wake-On-USB Keyboard/Mouse function for 2 USB ports, the +5V\_standby power source of your power supply must support  $\geq 1.5A$ . For 3 or more USB ports, the +5V\_standby power source of your power supply must support  $\geq 2A$ .

## Power-on Select (MB331-CRM)

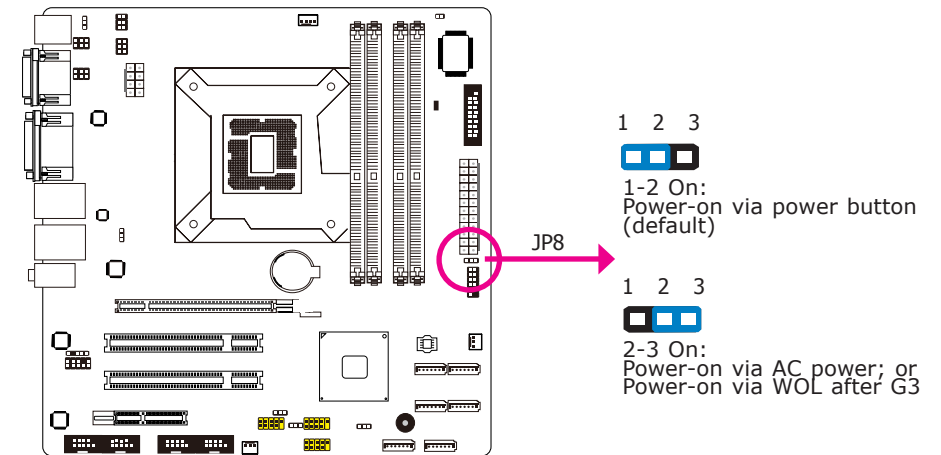

To power-on via WOL after G3:

1. Set JP8 pins 2 and 3 to On.
2. Set the "After G3" field to **Power Off/WOL**.
3. Set the "GbE Wake Up From S5" to **Enabled**.

The BIOS fields are in the "South Bridge Configuration" submenu (Chipset menu) of the AMI BIOS utility.

To power-on via AC Power:

1. Set JP8 pins 2 and 3 to On.
2. Set the "After G3" field to **Power On**.

**COM1/COM2 RS232/RS422/RS485 Select (MB331-CRM)**

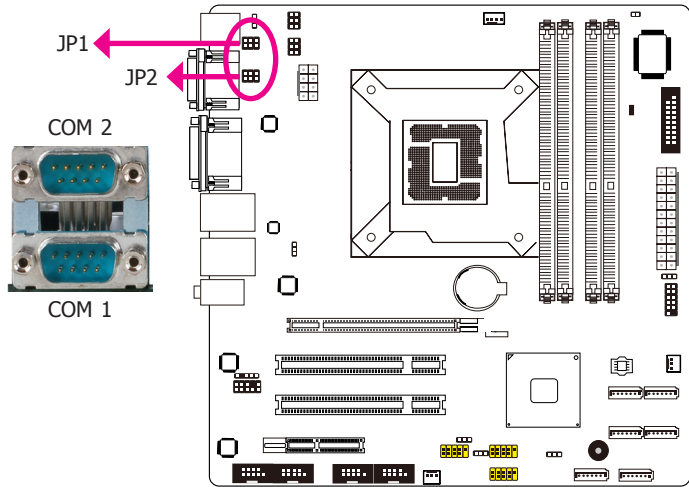

JP1 (for COM1) and JP2 (for COM2) are used to configure the COM ports to RS232, RS422 (Full Duplex) or RS485.

The pin function of the COM ports will vary according to the jumper's setting.

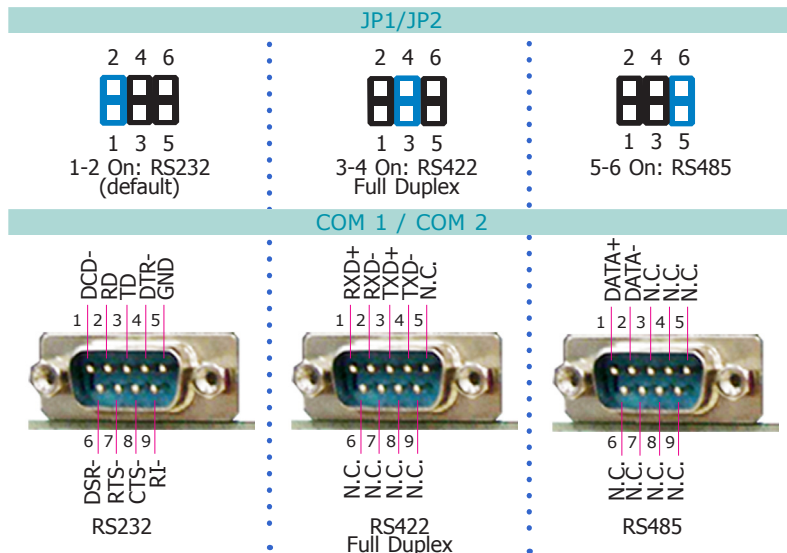

**COM1/COM2 RS232/Power Select (MB331-CRM)**

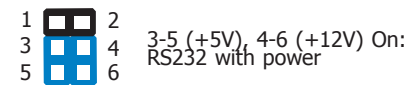
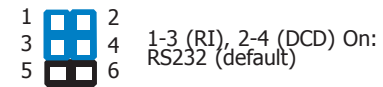
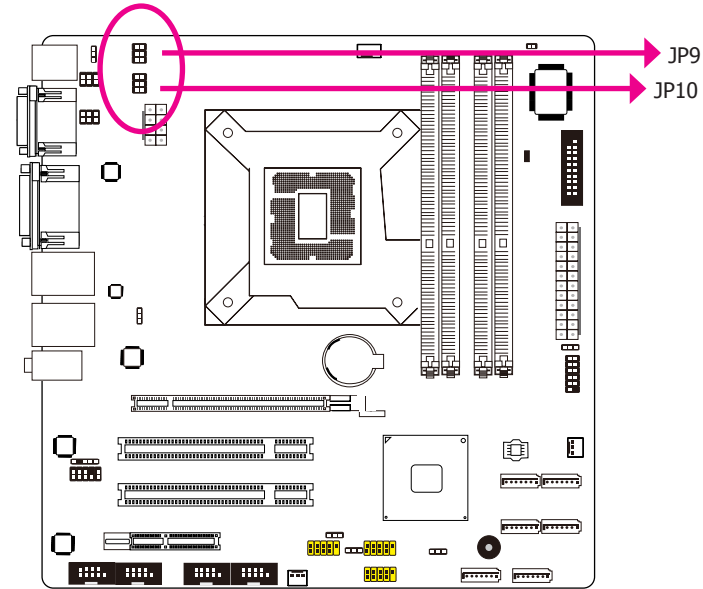

## Chapter 5 - Ports and Connectors

### Rear Panel I/O Ports (MB330-CRM)

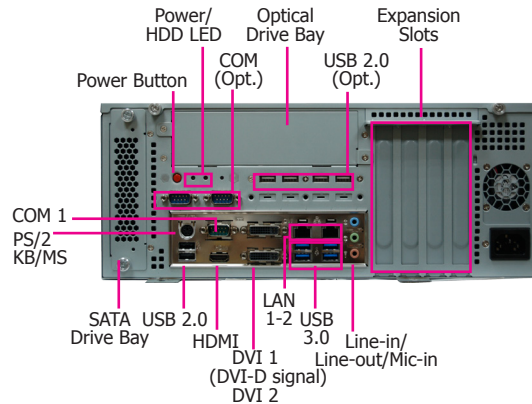

The rear panel I/O consists of the following ports:

- 1 PS/2 keyboard/mouse port
- 1 COM port (plus 2 optional)
- 2 DVI-I port (top: DVI-D signal)
- 1 HDMI port
- 2 RJ45 LAN ports
- 2 USB 2.0 ports (plus 4 optional)
- 4 USB 3.0 ports
- Line-out jack
- Line-in jack
- Mic-in jack

### PS/2 Keyboard/Mouse Port

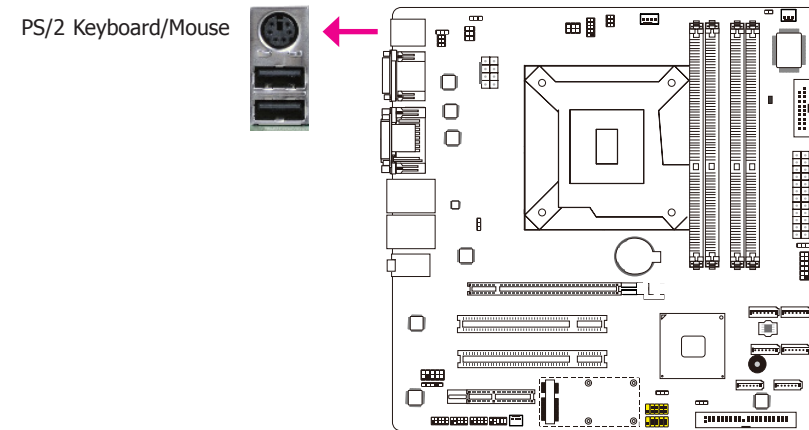

These ports are used to connect a PS/2 mouse and a PS/2 keyboard. The PS/2 mouse port uses IRQ12.

#### Wake-On-PS/2 Keyboard/Mouse

The Wake-On-PS/2 Keyboard/Mouse function allows you to use the PS/2 keyboard or PS/2 mouse to power-on the system. To use this function:

- **Jumper Setting**

JP1 must be set to "2-3 On: +5V\_standby". Refer to "PS/2 Power Select" in chapter 4 for more information.

- **BIOS Setting**

Configure the PS/2 keyboard/mouse wake up function in the Advanced menu ("ACPI Power Management Configuration" submenu) of the BIOS. Refer to chapter 7 -BIOS setup for more information.



**Important:**

The +5V\_standby power source of your power supply must support  $\geq 720\text{mA}$ .

## COM (Serial) Ports

COM 1, COM2 : RS232/422/485

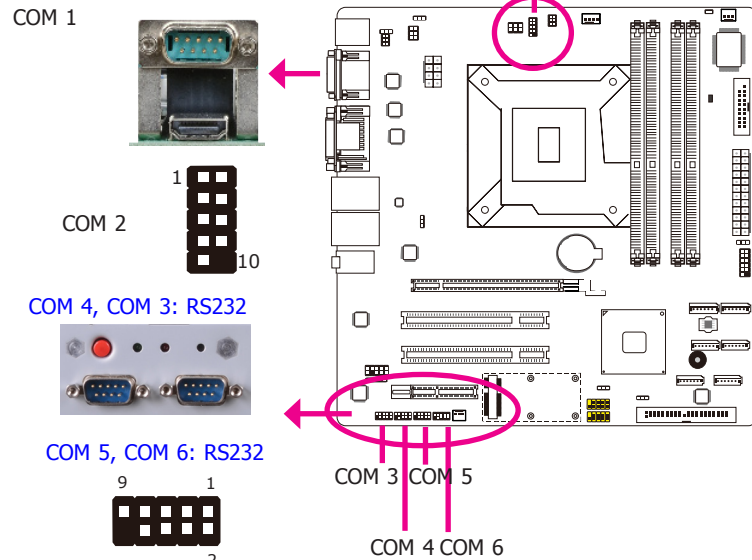

COM 3 to COM 6 are fixed at RS232.

The pin function of COM 1 and COM 2 ports will vary according to JP2 and JP7 setting respectively. Refer to "COM1/COM2 RS232/RS422/RS485 Select" in chapter 4 for more information.

The serial ports are asynchronous communication ports with 16C550A-compatible UARTs that can be used with modems, serial printers, remote display terminals, and other serial devices.

### Connecting External Serial Ports

Your COM port may come mounted on a card-edge bracket. Install the card-edge bracket to an available slot at the rear of the system chassis then insert the serial port cable to the COM connector. Make sure the colored stripe on the ribbon cable is aligned with pin 1 of the COM connector.

### BIOS Setting

Configure the serial ports in the Advanced menu ("Super IO Configuration" submenu) of the BIOS. Refer to chapter 7 for more information.

## Graphics Interfaces

The display ports consist of the following:

- 2 DVI-I port (top: DVI-D signal)
- 1 HDMI port

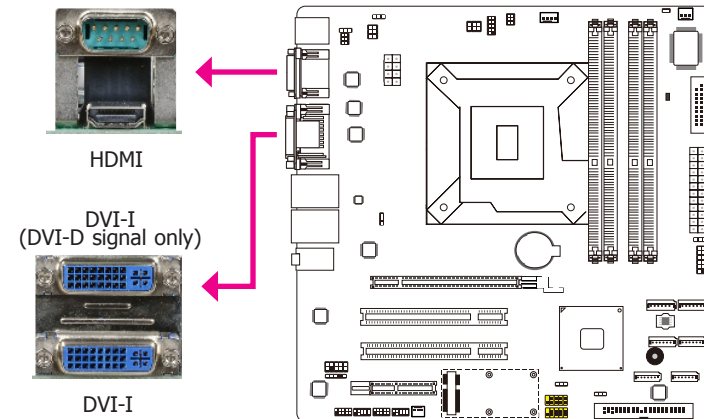

### HDMI Port

The HDMI port which carries both digital audio and video signals is used to connect a LCD monitor or digital TV that has the HDMI port.

### DVI-I Ports

The DVI ports are used to connect an LCD monitor. The board is equipped with 2 ports. The top one supports DVI-D signal only.

Connect the display device's cable connector to the DVI-I port. After you plug the cable connector into the port, gently tighten the cable screws to hold the connector in place.

### BIOS Setting

Configure the display device in the Chipset menu ("North Bridge Configuration" submenu) of the BIOS. Refer to chapter 7 for more information.

## RJ45 LAN Ports

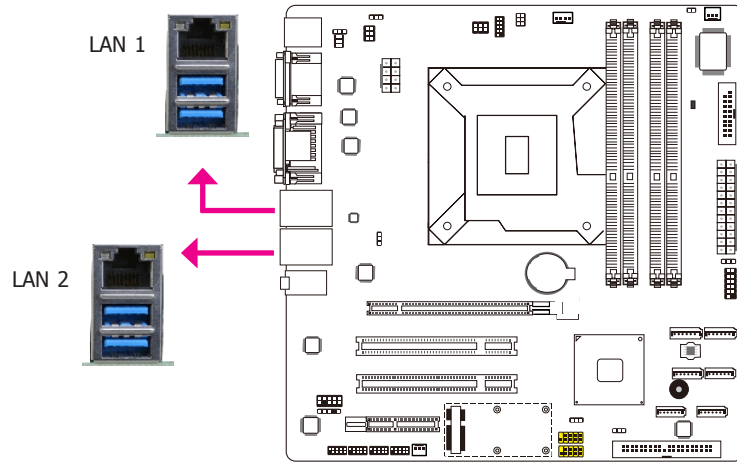

### Features

- Intel 82579LM with iAMT8.0 Gigabit Ethernet Phy
- Intel 82574L PCI Express Gigabit Ethernet controller

The LAN ports allow the system board to connect to a local area network by means of a network hub.

### BIOS Setting

Configure the onboard LAN in the Chipset menu ("South Bridge Configuration" submenu) of the BIOS. Refer to chapter 7- BIOS Setup for more information.

### Driver Installation

Install the LAN drivers. Refer to chapter 8 for more information.

## USB Ports

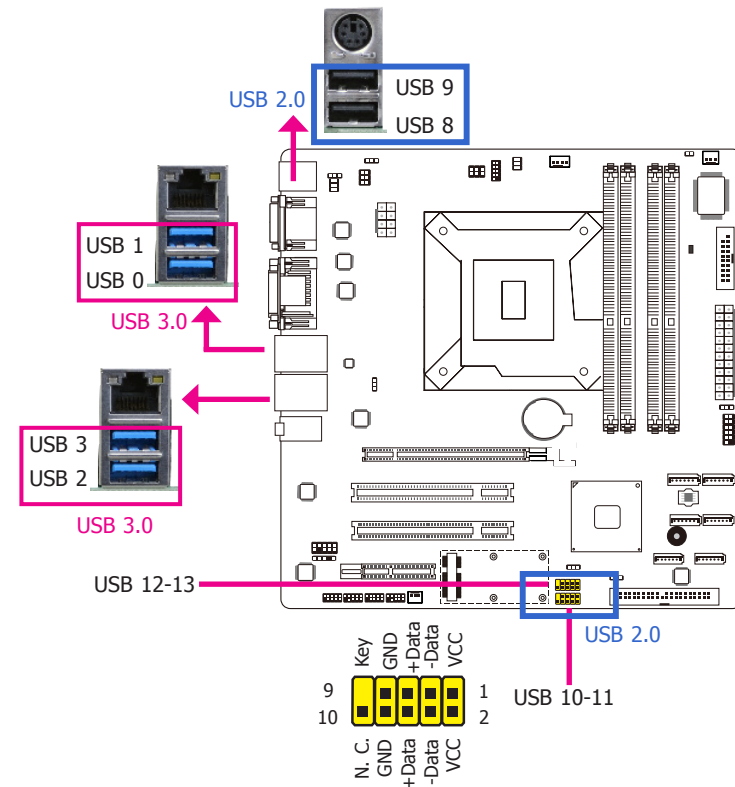

USB allows data exchange between your computer and a wide range of simultaneously accessible external Plug and Play peripherals.

The system board is equipped with four onboard USB 3.0/2.0/1.1 ports (0-3) and two onboard 2.0/1.1 ports (8-9). The two 10-pin connectors allow you to connect 4 additional USB 2.0/1.1 ports (USB 10-13). The additional USB ports may be mounted on a card-edge bracket. Install the card-edge bracket to an available slot at the rear of the system chassis and then insert the USB port cables to a connector.

### BIOS Setting

Configure the onboard USB in the Advanced menu ("USB Configuration" submenu) of the BIOS. Refer to chapter 7 for more information.

### Driver Installation

You may need to install the proper drivers in your operating system to use the USB device. Refer to your operating system's manual or documentation for more information.

### Wake-On-USB Keyboard/Mouse

The Wake-On-USB Keyboard/Mouse function allows you to use a USB keyboard or USB mouse to wake up a system from the S3 (STR - Suspend To RAM) state. To use this function:

- **Jumper Setting**

JP4, JP5 and/or JP8 must be set to "2-3 On: 5V\_standby". Refer to "USB Power Select" in chapter 4 for more information.



#### Important:

If you are using the Wake-On-USB Keyboard/Mouse function for 2 USB ports, the +5V\_standby power source of your power supply must support  $\geq 1.5A$ . For 3 or more USB ports, the +5V\_standby power source of your power supply must support  $\geq 2A$ .

## Audio

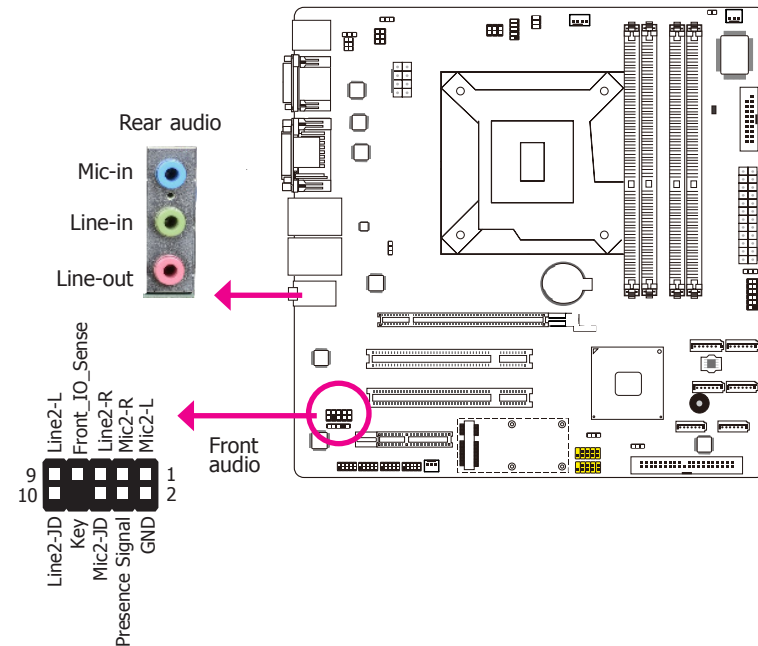

### Rear Audio

The system board is equipped with 3 audio jacks. A jack is a one-hole connecting interface for inserting a plug.

- **Mic-in Jack (Pink)**  
This jack is used to connect an external microphone.
- **Line-in Jack (Light blue)**  
This jack is used to connect any audio devices such as Hi-fi set, CD player, tape player, AM/FM radio tuner, synthesizer, etc.
- **Line-out Jack (Lime)**  
This jack is used to connect a headphone or external speakers.

### Front Audio

The front audio connector allows you to connect to the second line-out and mic-in jacks that are at the front panel of your system.

**BIOS Setting**

Configure the onboard audio in the Chipset menu ("South Bridge" submenu) of the BIOS. Refer to chapter 7 for more information.

**Driver Installation**

Install the audio driver. Refer to chapter 8 for more information.

## I/O Connectors (MB330-CRM)

### S/PDIF Connector

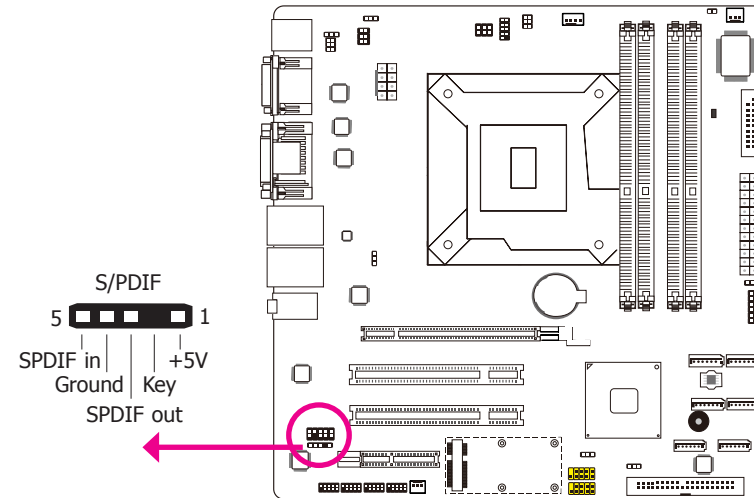

The S/PDIF connector is used to connect an external S/PDIF port. Your S/PDIF port may be mounted on a card-edge bracket. Install the card-edge bracket to an available slot at the rear of the system chassis then connect the audio cable to the S/PDIF connector. Make sure pin 1 of the audio cable is aligned with pin 1 of the S/PDIF connector.

## Digital I/O Connector

### Digital I/O Power Connector

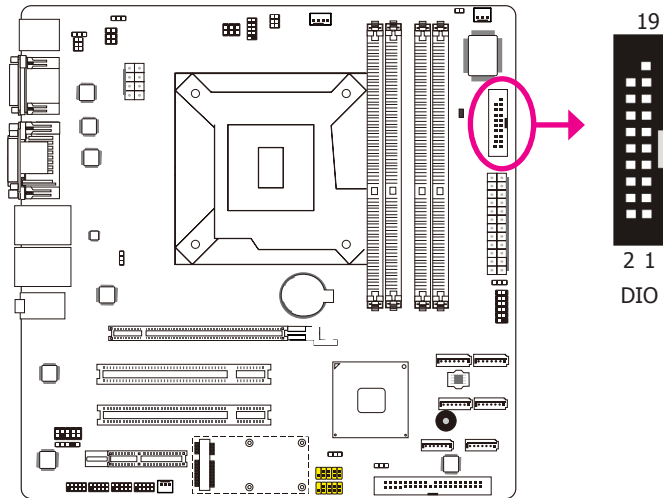

The 8-bit Digital I/O connector provides powering-on function to external devices that are connected to these connectors.

Pin	Pin Assignment	Pin	Pin Assignment
1	GND	2	+12V
3	DIO7	4	+12V
5	DIO6	6	GND
7	DIO5	8	VCC
9	DIO4	10	VCC
11	DIO3	12	GND
13	DIO2	14	V_5P0_STBY
15	DIO1	16	V_5P0_STBY
17	DIO0	18	GND
19	GND		

## SATA (Serial ATA) Connectors

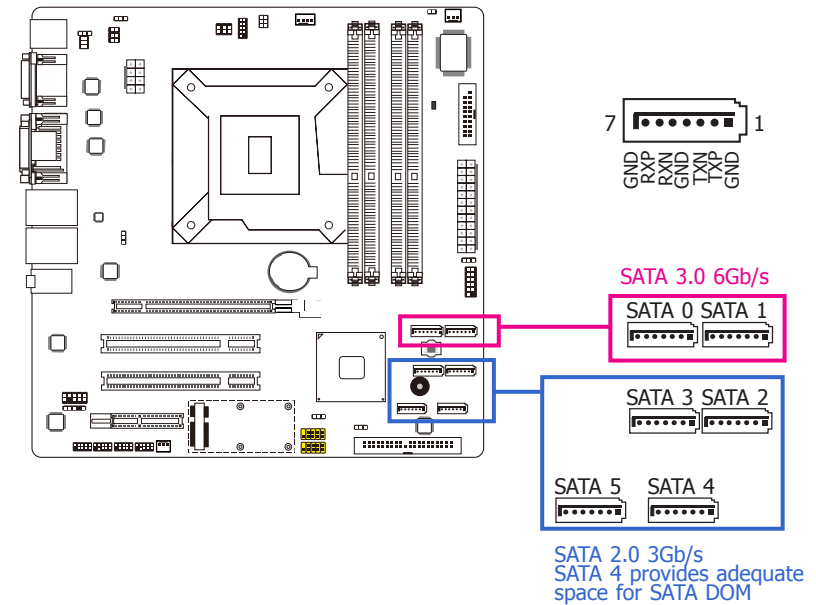

### Features

- SATA 0 and SATA 1 support data transfer rate up to 6Gb/s
- SATA 2 to SATA 5 support data transfer rate up to 3Gb/s  
SATA 4 provides adequate space for SATA DOM
- Integrated Advanced Host Controller Interface (AHCI) controller
- Supports RAID 0, RAID 1, RAID 5 and RAID 10

The Serial ATA connectors are used to connect Serial ATA devices. Connect one end of the Serial ATA cable to a SATA connector and the other end to your Serial ATA device.

### BIOS Setting

Configure the Serial ATA drives in the Advanced menu of the BIOS. Refer to chapter 7 for more information.



## Cooling Fan Connectors

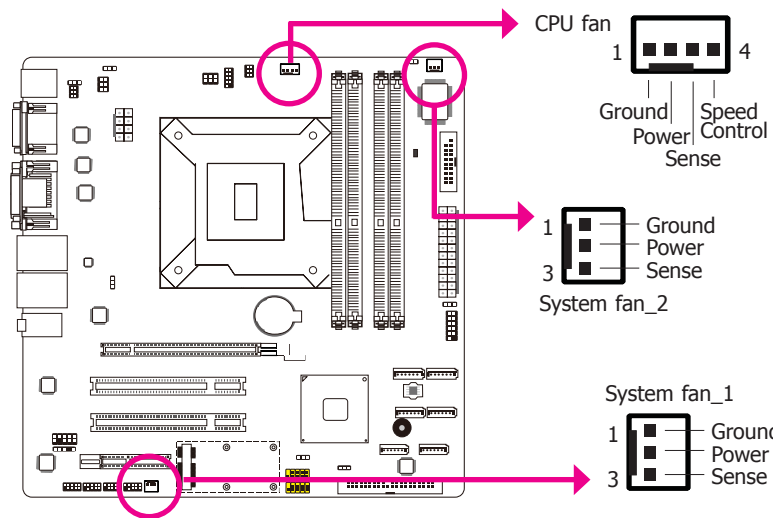

The fan connectors are used to connect cooling fans. The cooling fans will provide adequate airflow throughout the chassis to prevent overheating the CPU and system board components.

### BIOS Setting

The Advanced menu ("Hardware Health Configuration" submenu) of the BIOS will display the current speed of the cooling fans. Refer to chapter 7 for more information.

## Chassis Intrusion Connector

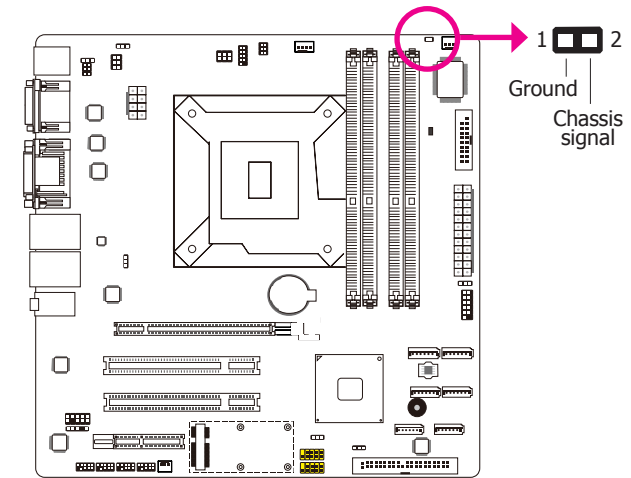

The board supports the chassis intrusion detection function. Connect the chassis intrusion sensor cable from the chassis to this connector. When the system's power is on and a chassis intrusion occurred, an alarm will sound. When the system's power is off and a chassis intrusion occurred, the alarm will sound only when the system restarts.

### MyGuard Hardware Monitor

Install the "MyGuard Hardware Monitor" utility. By default, the chassis intrusion detection function is disabled. When enabled, a warning message will appear when the chassis is open. The utility can also be configured so that a beeping alarm will sound when the chassis is open. Refer to the "MyGuard Hardware Monitor" section in chapter 7 for more information.

## Power Connectors

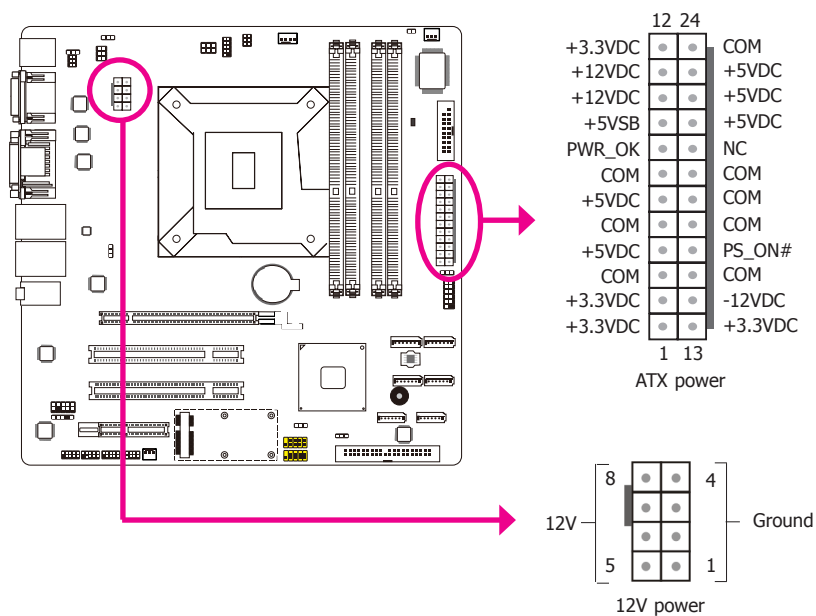

Use a power supply that complies with the ATX12V Power Supply Design Guide Version 1.1. An ATX12V power supply unit has a standard 24-pin ATX main power connector that must be inserted into the 24-pin connector. The 8-pin +12V power connector enables the delivery of more +12VDC current to the processor's Voltage Regulator Module (VRM).

The power connectors from the power supply unit are designed to fit the 24-pin and 8-pin connectors in only one orientation. Make sure to find the proper orientation before plugging the connectors.

The system board requires a minimum of 300 Watt power supply to operate. Your system configuration (CPU power, amount of memory, add-in cards, peripherals, etc.) may exceed the minimum power requirement. To ensure that adequate power is provided, we strongly recommend that you use a minimum of 400 Watt (or greater) power supply.



### Important:

Insufficient power supplied to the system may result in instability or the add-in boards and peripherals not functioning properly. Calculating the system's approximate power usage is important to ensure that the power supply meets the system's consumption requirements.

## Standby Power LED

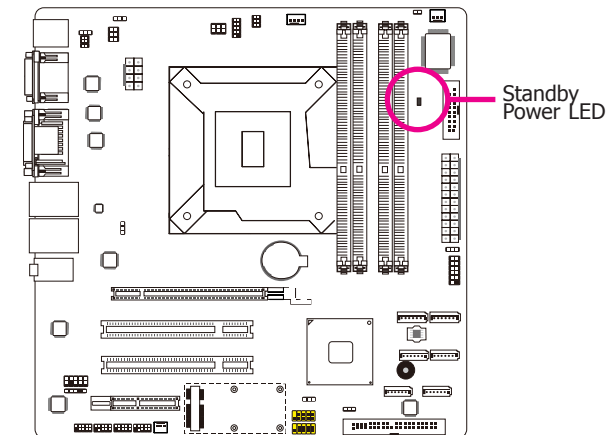

This LED will light red when the system is in the standby mode. It indicates that there is power on the system board. Power-off the PC and then unplug the power cord prior to installing any devices. Failure to do so will cause severe damage to the motherboard and components.

### Front Panel Connector

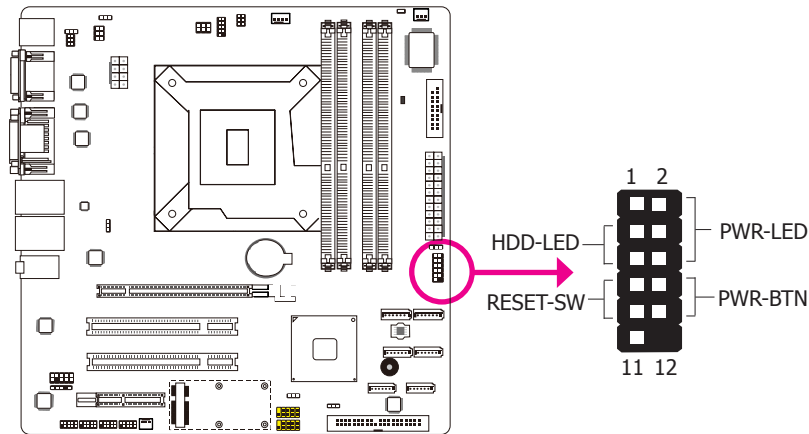

#### HDD-LED - HDD LED

This LED will light when the hard drive is being accessed.

#### RESET SW - Reset Switch

This switch allows you to reboot without having to power off the system.

#### PWR-BTN - Power Switch

This switch is used to power on or off the system.

#### PWR-LED - Power/Standby LED

When the system's power is on, this LED will light. When the system is in the S1 (POS - Power On Suspend) state, it will blink every second. When the system is in the S3 (STR - Suspend To RAM) state, it will blink every 4 seconds.

	Pin	Pin Assignment		Pin	Pin Assignment
HDD-LED	3	HDD Power	PWR-LED	2	LED Power
	5	Signal		4	LED Power
RESET SW	7	Ground	PWR-BTN	6	Signal
	9	RST Signal		8	Ground
	11	N.C.		10	Signal

### Expansion Slots

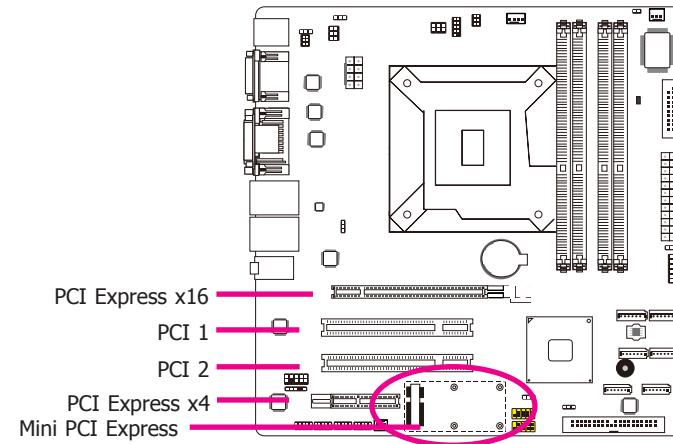

#### PCI Express x16 Slot

Install PCI Express x16 graphics card, that comply to the PCI Express specifications, into the PCI Express x16 slot. To install a graphics card into the x16 slot, align the graphics card above the slot then press it down firmly until it is completely seated in the slot. The retaining clip of the slot will automatically hold the graphics card in place.

#### PCI Express x4 Slot

Install PCI Express cards such as network cards or other cards that comply to the PCI Express specifications into the PCI Express x4 slot.

#### PCI Slots

The PCI slot supports expansion cards that comply with PCI specifications.

#### Mini PCIe Slot (not supports m-SATA)

The Mini PCIe socket is used to install a Mini PCIe card. Mini PCIe card is a small form factor PCI card with the same signal protocol, electrical definitions, and configuration definitions as the conventional PCI.

## IDE Connector

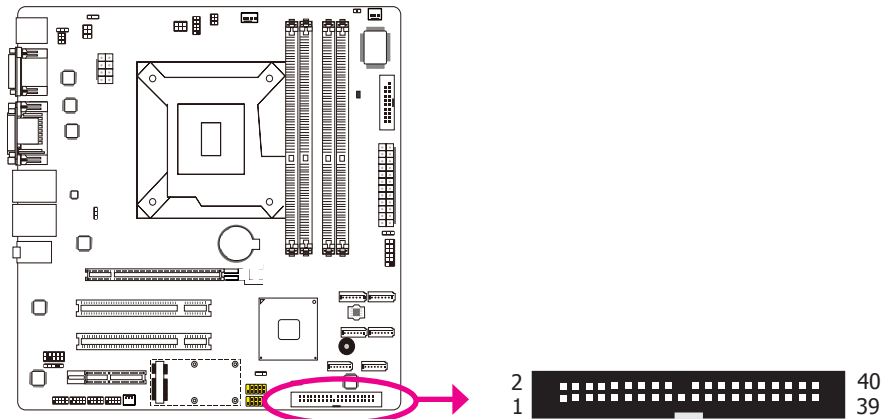

The IDE connector is used to connect hard drives. The connector on the IDE cable can be inserted into this connector only if pin 1 of the cable is aligned with pin 1 of this connector.

The IDE connector supports 2 devices, a Master and a Slave. Use an IDE ribbon cable to connect the drives to the system board. An IDE ribbon cable has 3 connectors on them, one that plugs into the IDE connector on the system board and the other 2 connects to IDE devices. The connector at the end of the cable is for the Master drive and the connector in the middle of the cable is for the Slave drive.



### Note:

Refer to your disk drive user's manual for information about selecting proper drive switch settings.

## Adding a Second IDE Disk Drive

When using two IDE drives, one must be set as the master and the other as the slave. Follow the instructions provided by the drive manufacturer for setting the jumpers and/or switches on the drives.

The system board supports Enhanced IDE or ATA-2, ATA/33, ATA/66, ATA/100 and ATA/133 hard drives. We recommend that you use hard drives from the same manufacturer. In a few cases, drives from two different manufacturers will not function properly when used together. The problem lies in the hard drives, not the system board.



### Important:

If you encountered problems while using an ATAPI CD-ROM drive that is set in Master mode, please set the CD-ROM drive to Slave mode. Some ATAPI CD-ROMs may not be recognized and cannot be used if incorrectly set in Master mode.

## BIOS Setting

Configure the onboard IDE in the Integrated Peripherals submenu (JMB36X ATA Configuration section) of the BIOS. Refer to chapter 7 - BIOS Setup for more information.

## Battery

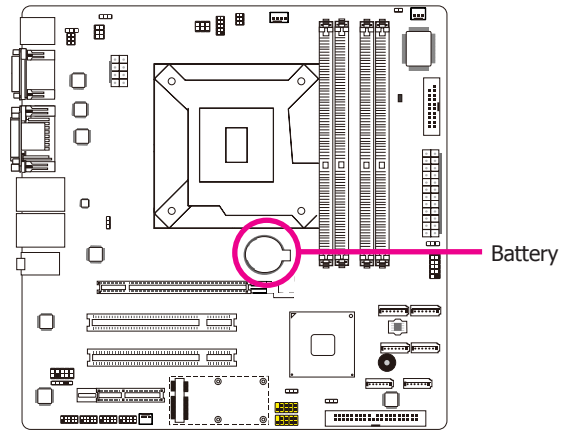

The lithium ion battery powers the real-time clock and CMOS memory. It is an auxiliary source of power when the main power is shut off.

### Safety Measures

- Danger of explosion if battery incorrectly replaced.
- Replace only with the same or equivalent type recommend by the manufacturer.
- Dispose of used batteries according to local ordinance.

## Rear Panel I/O Ports (MB331-CRM)

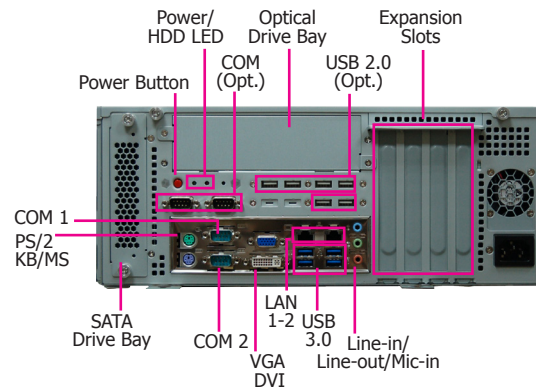

The rear panel I/O consists of the following ports:

- 1 PS/2 keyboard and mouse port
- 2 COM port (plus 2 optional)
- 1 VGA port
- 1 DVI-I port (DVI-D signal)
- 2 RJ45 LAN ports
- 4 USB 3.0 ports (plus 6 optional USB 2.0 ports)
- Line-out jack
- Line-in jack
- Mic-in jack

## PS/2 Keyboard/Mouse Ports

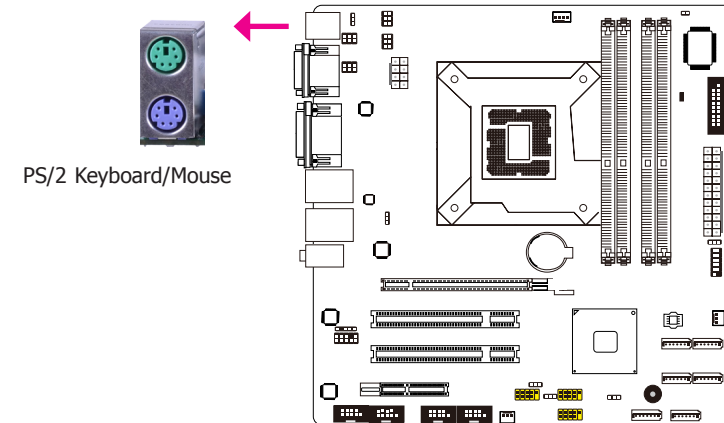

These ports are used to connect a PS/2 mouse and a PS/2 keyboard. The PS/2 mouse port uses IRQ12.

### Wake-On-PS/2 Keyboard/Mouse

The Wake-On-PS/2 Keyboard/Mouse function allows you to use the PS/2 keyboard or PS/2 mouse to power-on the system. To use this function:

- **Jumper Setting**

JP3 must be set to "2-3 On: +5V\_standby". Refer to "PS/2 Power Select" in chapter 4 for more information.

- **BIOS Setting**

Configure the PS/2 keyboard/mouse wake up function in the Advanced menu ("ACPI Power Management Configuration" submenu) of the BIOS. Refer to chapter 7 for more information.



### Important:

The +5V\_standby power source of your power supply must support  $\geq 720\text{mA}$ .

## COM (Serial) Ports

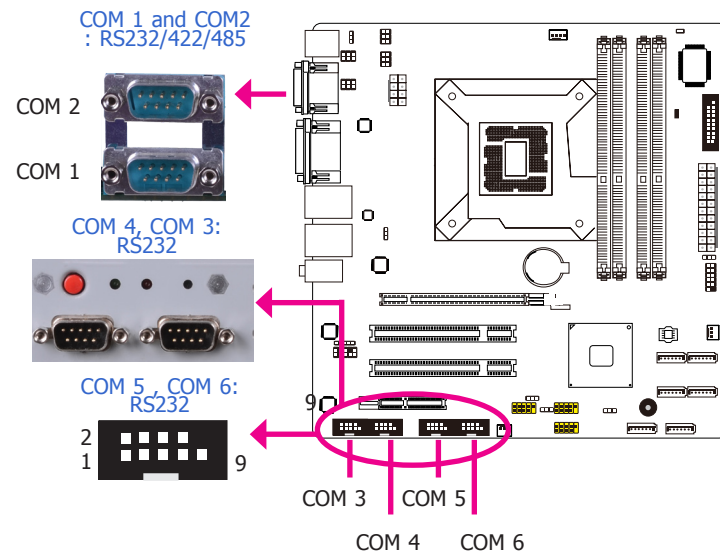

COM 3 to COM 6 are fixed at RS232.

The pin function of COM 1 and COM 2 ports will vary according to JP1 and JP2's setting respectively. Refer to "COM1/COM2 RS232/RS422/RS485 Select" in chapter 4 for more information.

The serial ports are asynchronous communication ports with 16C550A-compatible UARTs that can be used with modems, serial printers, remote display terminals, and other serial devices.

### Connecting External Serial Ports

Your COM port may come mounted on a card-edge bracket. Install the card-edge bracket to an available slot at the rear of the system chassis then insert the serial port cable to the COM connector. Make sure the colored stripe on the ribbon cable is aligned with pin 1 of the COM connector.

### BIOS Setting

Configure the serial ports in the Advanced menu ("Super IO Configuration" submenu) of the BIOS. Refer to chapter 7 for more information.

## Graphics Interfaces

The display ports consist of the following:

- 1 VGA port
- 1 DVI-I port (DVI-D signal only)

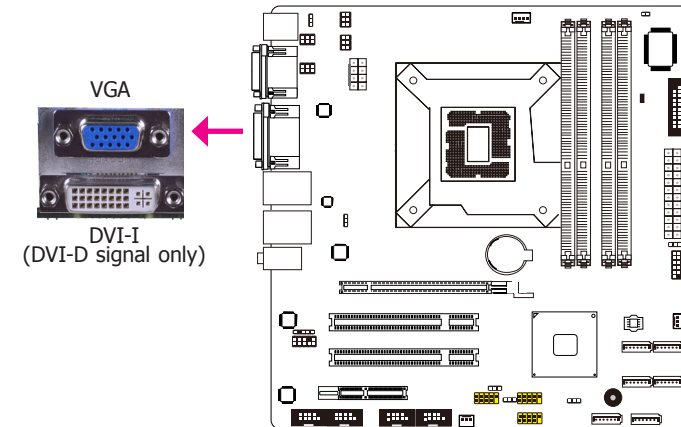

### VGA Port

The VGA port is used for connecting a VGA monitor. Connect the monitor's 15-pin D-shell cable connector to the VGA port. After you plug the monitor's cable connector into the VGA port, gently tighten the cable screws to hold the connector in place.

### DVI-I Ports

The DVI-I port is used to connect an LCD monitor. This port supports DVI-D signal only.

Connect the display device's cable connector to the DVI-I port. After you plug the cable connector into the port, gently tighten the cable screws to hold the connector in place.

### BIOS Setting

Configure the display device in the Chipset menu ("North Bridge Configuration" submenu) of the BIOS. Refer to chapter 7 for more information.

### Driver Installation

Install the VGA graphics driver. Refer to chapter 8 for more information.





## Wake-On-USB Keyboard/Mouse

The Wake-On-USB Keyboard/Mouse function allows you to use a USB keyboard or USB mouse to wake up a system from the S3 (STR - Suspend To RAM) state. To use this function:

- **Jumper Setting**

JP11, JP5 and/or JP6 must be set to "2-3 On: 5V\_standby". Refer to "USB Power Select" in chapter 4 for more information.



### Important:

If you are using the Wake-On-USB Keyboard/Mouse function for 2 USB ports, the +5V\_standby power source of your power supply must support  $\geq 1.5A$ . For 3 or more USB ports, the +5V\_standby power source of your power supply must support  $\geq 2A$ .

## Audio

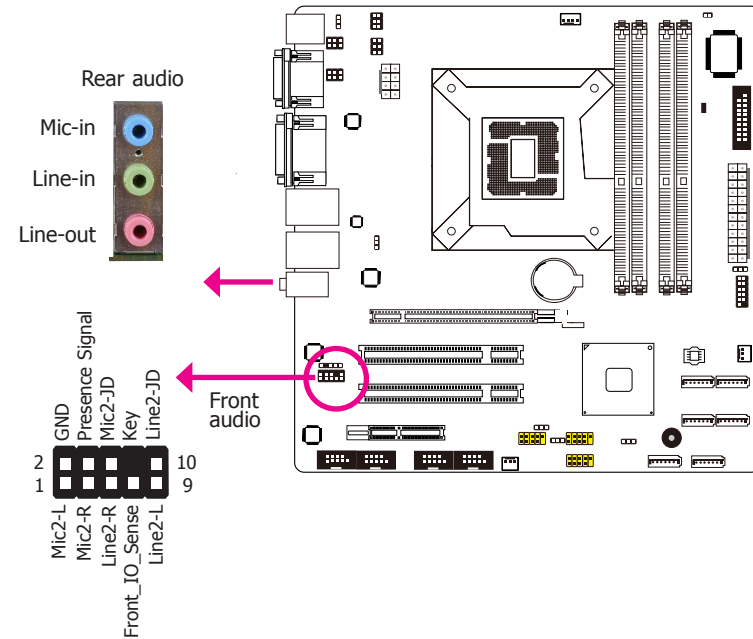

### Rear Audio

The system board is equipped with 3 audio jacks. A jack is a one-hole connecting interface for inserting a plug.

- **Line-in Jack (Light Blue)**  
This jack is used to connect any audio devices such as Hi-fi set, CD player, tape player, AM/FM radio tuner, synthesizer, etc.
- **Line-out Jack (Lime)**  
This jack is used to connect a headphone or external speakers.
- **Mic-in Jack (Pink)**  
This jack is used to connect an external microphone.

### Front Audio

The front audio connector allows you to connect to the second line-out and mic-in jacks that are at the front panel of your system.

**BIOS Setting**

Configure the onboard audio in the Chipset menu ("South Bridge" submenu) of the BIOS. Refer to chapter 7 for more information.

**Driver Installation**

Install the audio driver. Refer to chapter 8 for more information.

## I/O Connectors (MB331-CRM)

### S/PDIF Connector

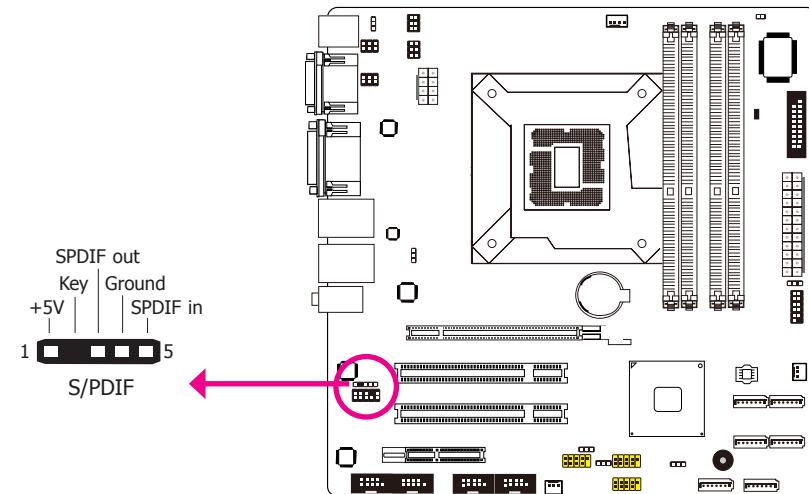

The S/PDIF connector is used to connect an external S/PDIF port. Your S/PDIF port may be mounted on a card-edge bracket. Install the card-edge bracket to an available slot at the rear of the system chassis then connect the audio cable to the S/PDIF connector. Make sure pin 1 of the audio cable is aligned with pin 1 of the S/PDIF connector.

### Digital I/O Connector

### Digital I/O Power Connector

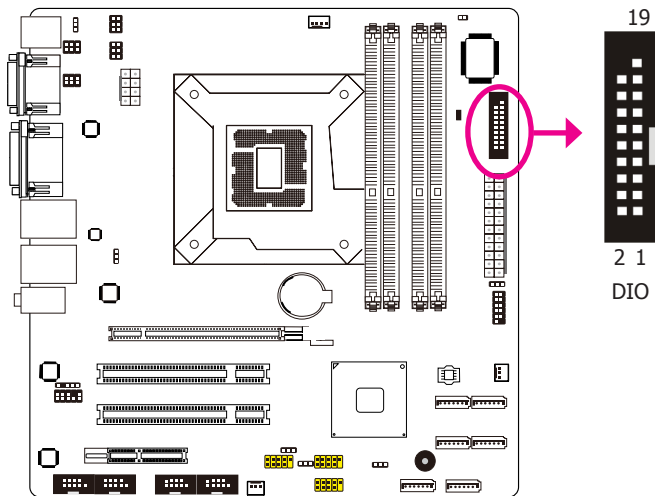

The 8-bit Digital I/O connector provides powering-on function to external devices that are connected to these connectors.

Pin	Pin Assignment	Pin	Pin Assignment
1	GND	2	+12V
3	DIO7	4	+12V
5	DIO6	6	GND
7	DIO5	8	VCC
9	DIO4	10	VCC
11	DIO3	12	GND
13	DIO2	14	V_5P0_STBY
15	DIO1	16	V_5P0_STBY
17	DIO0	18	GND
19	GND		

### SATA (Serial ATA) Connectors

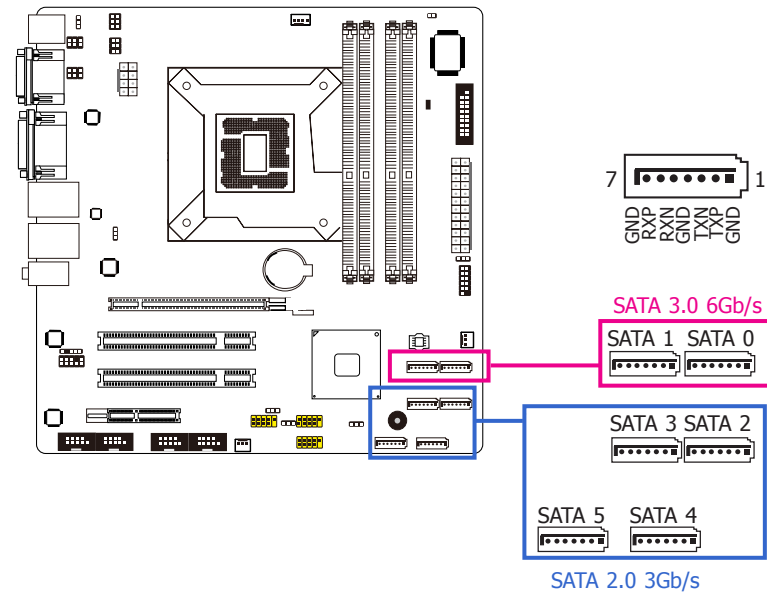

#### Features

- SATA 0 and SATA 1 support data transfer rate up to 6Gb/s
- SATA 2 to SATA 5 support data transfer rate up to 3Gb/s
- Integrated Advanced Host Controller Interface (AHCI) controller
- Supports RAID 0, RAID 1, RAID 5 and RAID 10

The Serial ATA connectors are used to connect Serial ATA devices. Connect one end of the Serial ATA cable to a SATA connector and the other end to your Serial ATA device.

#### BIOS Setting

Configure the Serial ATA drives in the Advanced menu ("IDE Configuration" submenu) of the BIOS. Refer to chapter 7 for more information.

## Cooling Fan Connectors

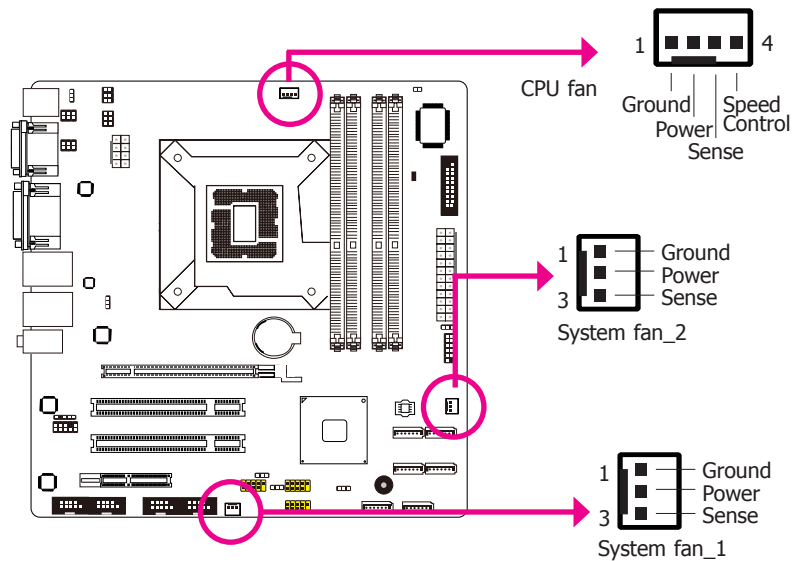

The fan connectors are used to connect cooling fans. The cooling fans will provide adequate airflow throughout the chassis to prevent overheating the CPU and system board components.

### BIOS Setting

The Advanced menu ("Hardware Health Configuration" submenu) of the BIOS will display the current speed of the cooling fans. Refer to chapter 7 for more information.

## Chassis Intrusion Connector

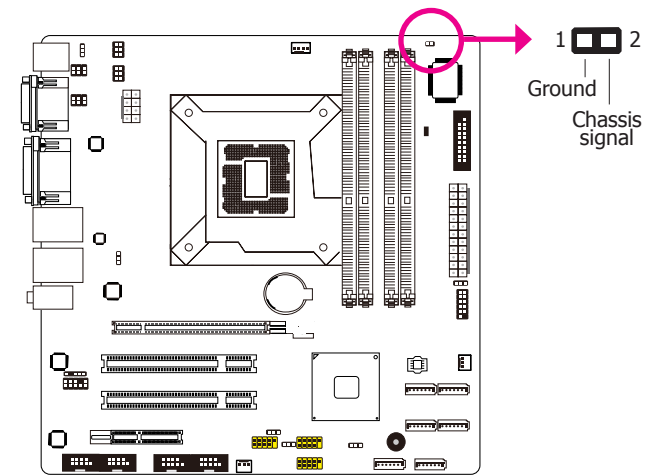

The board supports the chassis intrusion detection function. Connect the chassis intrusion sensor cable from the chassis to this connector. When the system's power is on and a chassis intrusion occurred, an alarm will sound. When the system's power is off and a chassis intrusion occurred, the alarm will sound only when the system restarts.

### MyGuard Hardware Monitor

Install the "MyGuard Hardware Monitor" utility. By default, the chassis intrusion detection function is disabled. When enabled, a warning message will appear when the chassis is open. The utility can also be configured so that a beeping alarm will sound when the chassis is open. Refer to the "MyGuard Hardware Monitor" section in chapter 7 for more information.

## Power Connectors

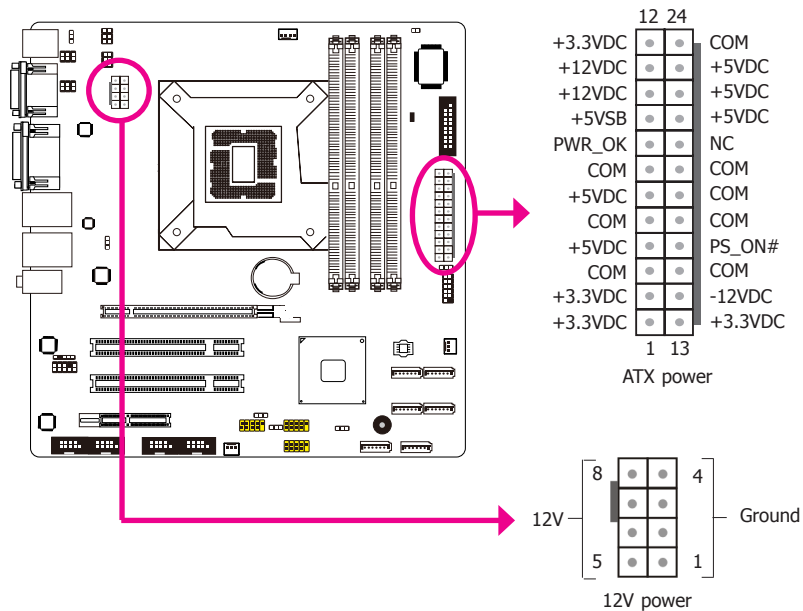

Use a power supply that complies with the ATX12V Power Supply Design Guide Version 1.1. An ATX12V power supply unit has a standard 24-pin ATX main power connector that must be inserted into the 24-pin connector. The 8-pin +12V power connector enables the delivery of more +12VDC current to the processor's Voltage Regulator Module (VRM).

The power connectors from the power supply unit are designed to fit the 24-pin and 8-pin connectors in only one orientation. Make sure to find the proper orientation before plugging the connectors.

The system board requires a minimum of 300 Watt power supply to operate. Your system configuration (CPU power, amount of memory, add-in cards, peripherals, etc.) may exceed the minimum power requirement. To ensure that adequate power is provided, we strongly recommend that you use a minimum of 400 Watt (or greater) power supply.



### Important:

Insufficient power supplied to the system may result in instability or the add-in boards and peripherals not functioning properly. Calculating the system's approximate power usage is important to ensure that the power supply meets the system's consumption requirements.

## Standby Power LED

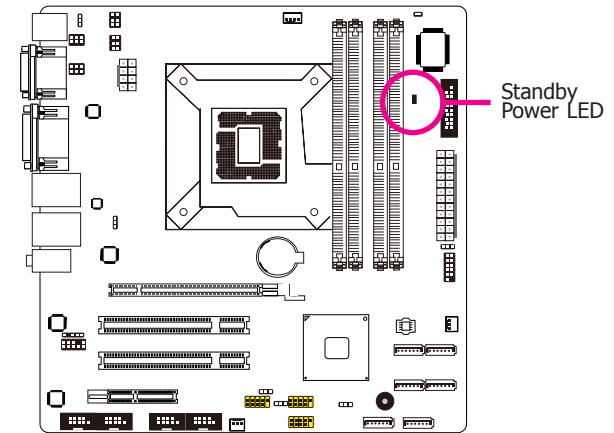

This LED will light red when the system is in the standby mode. It indicates that there is power on the system board. Power-off the PC and then unplug the power cord prior to installing any devices. Failure to do so will cause severe damage to the motherboard and components.

## Front Panel Connector

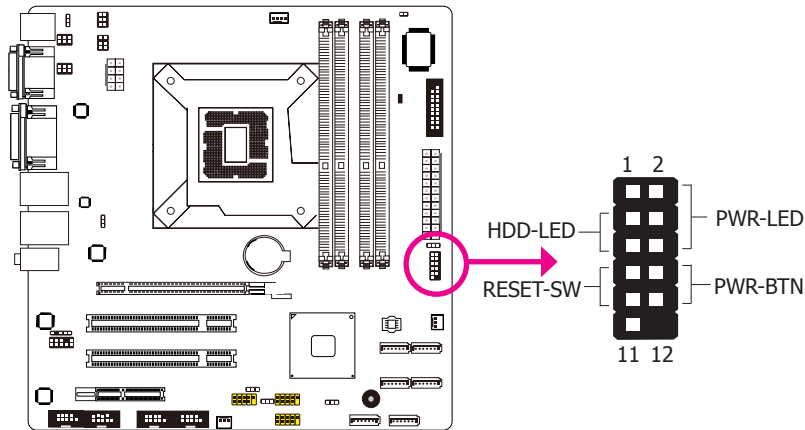

### HDD-LED - HDD LED

This LED will light when the hard drive is being accessed.

### RESET SW - Reset Switch

This switch allows you to reboot without having to power off the system.

### PWR-BTN - Power Switch

This switch is used to power on or off the system.

### PWR-LED - Power/Standby LED

When the system's power is on, this LED will light. When the system is in the S1 (POS - Power On Suspend) state, it will blink every second. When the system is in the S3 (STR - Suspend To RAM) state, it will blink every 4 seconds.

	Pin	Pin Assignment		Pin	Pin Assignment
HDD-LED	3	HDD Power	PWR-LED	2	LED Power
	5	Signal		4	LED Power
RESET SW	7	Ground	PWR-BTN	6	Signal
	9	RST Signal		8	Ground
	11	N.C.		10	Signal

## Expansion Slots

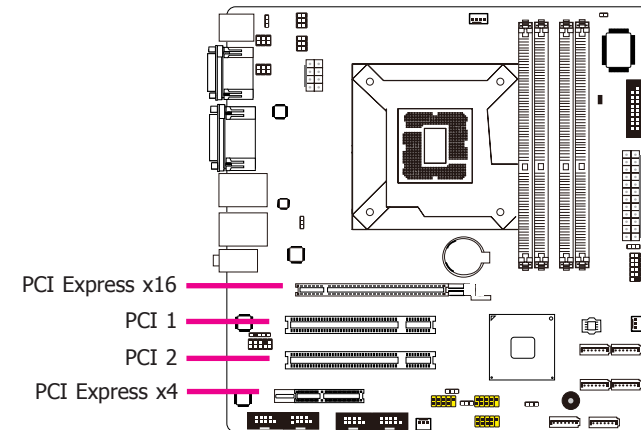

### PCI Express x16 Slot

Install PCI Express x16 graphics card, that comply to the PCI Express specifications, into the PCI Express x16 slot. To install a graphics card into the x16 slot, align the graphics card above the slot then press it down firmly until it is completely seated in the slot. The retaining clip of the slot will automatically hold the graphics card in place.

### PCI Express x4 Slot

Install PCI Express cards such as network cards or other cards that comply to the PCI Express specifications into the PCI Express x4 slot.

### PCI Slots

The PCI slot supports expansion cards that comply with PCI specifications.

## Battery

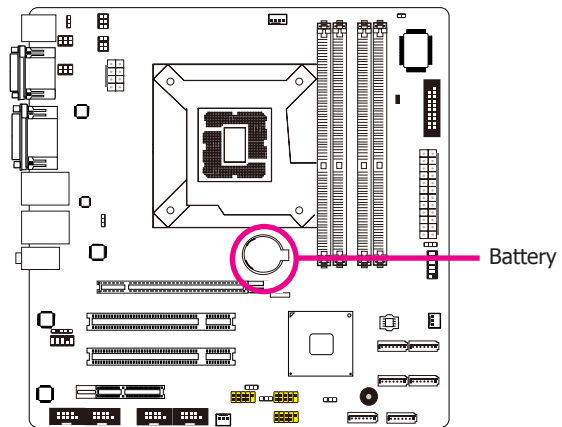

The lithium ion battery powers the real-time clock and CMOS memory. It is an auxiliary source of power when the main power is shut off.

### Safety Measures

- Danger of explosion if battery incorrectly replaced.
- Replace only with the same or equivalent type recommend by the manufacturer.
- Dispose of used batteries according to local ordinance.

## Chapter 6 - Mounting Options



**Note:**

The system unit used in the following illustrations may not resemble the actual one. These illustrations are for reference only.

There are 2 mount brackets available:

- Wall mount



- Rack-mount tray bracket

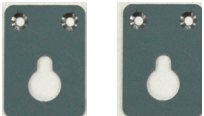

### Wall Mount



Wall mount kit include:

- 2 wall mount brackets



1. On the bottom of the system, use 4 mounting screws to secure the wall mount brackets on each side of the system.

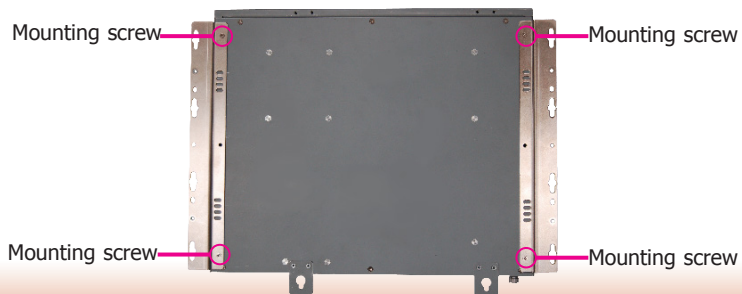

The mechanical drawing of the wall mount illustration with dimensions.

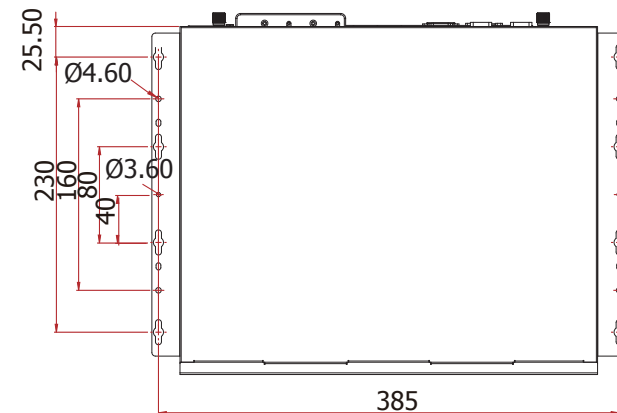
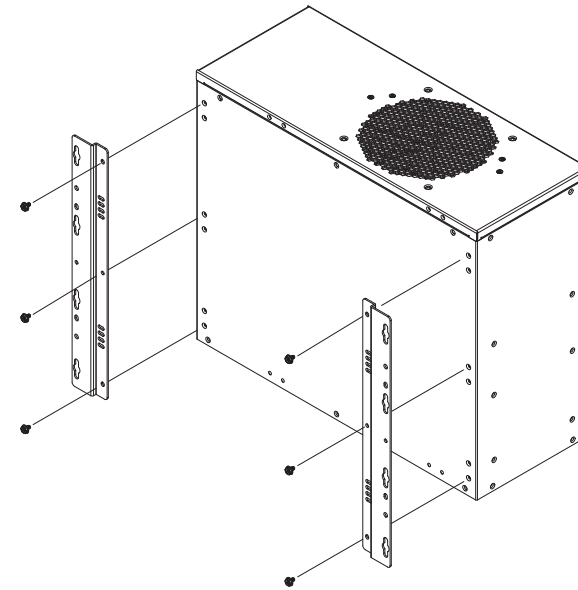



## Rack Tray Mount

-  Rack-mount tray kit include:
- 2 Rack-mount tray brackets

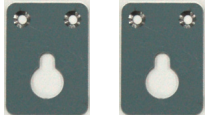

1. Place the system on the rack-mount tray and align the mounting holes of the tray with the mount bracket.
2. Follow the rack manufacture's instruction to properly secure the system to the rack.

## Chapter 7 - BIOS Setup

### Overview

The BIOS is a program that takes care of the basic level of communication between the CPU and peripherals. It contains codes for various advanced features found in this system board. The BIOS allows you to configure the system and save the configuration in a battery-backed CMOS so that the data retains even when the power is off. In general, the information stored in the CMOS RAM of the EEPROM will stay unchanged unless a configuration change has been made such as a hard drive replaced or a device added.

It is possible that the CMOS battery will fail causing CMOS data loss. If this happens, you need to install a new CMOS battery and reconfigure the BIOS settings.

**Note:**

The BIOS is constantly updated to improve the performance of the system board; therefore the BIOS screens in this chapter may not appear the same as the actual one. These screens are for reference purpose only.

### Default Configuration

Most of the configuration settings are either predefined according to the Load Optimal Defaults settings which are stored in the BIOS or are automatically detected and configured without requiring any actions. There are a few settings that you may need to change depending on your system configuration.

### Entering the BIOS Setup Utility

The BIOS Setup Utility can only be operated from the keyboard and all commands are keyboard commands. The commands are available at the right side of each setup screen.

The BIOS Setup Utility does not require an operating system to run. After you power up the system, the BIOS message appears on the screen and the memory count begins. After the memory test, the message "Press DEL to run setup" will appear on the screen. If the message disappears before you respond, restart the system or press the "Reset" button. You may also restart the system by pressing the <Ctrl> <Alt> and <Del> keys simultaneously.

### Legends

Keys	Function
Right and Left arrows	Moves the highlight left or right to select a menu.
Up and Down arrows	Moves the highlight up or down between submenu or fields.
<Esc>	Exit to the BIOS Setup Utility.
+ (plus key)	Scrolls forward through the values or options of the highlighted field.
- (minus key)	Scrolls backward through the values or options of the highlighted field.
Tab	Select a field.
<F1>	Displays general help
<F2>	Pervious values
<F3>	Optimized defaults
<F4>	Saves and exits the setup program.
<Enter>	Press <Enter> to enter the highlighted submenu.

### Scroll Bar

When a scroll bar appears to the right of the setup screen, it indicates that there are more available fields not shown on the screen. Use the up and down arrow keys to scroll through all the available fields.

### Submenu

When "▶" appears on the left of a particular field, it indicates that a submenu which contains additional options are available for that field. To display the submenu, move the highlight to that field and press <Enter>.

## AMI BIOS Setup Utility (MB330-CRM)

### Main

The Main menu is the first screen that you will see when you enter the BIOS Setup Utility.



### System Date

The date format is <day>, <month>, <date>, <year>. Day displays a day, from Sunday to Saturday. Month displays the month, from January to December. Date displays the date, from 1 to 31. Year displays the year, from 1980 to 2099.

### System Time

The time format is <hour>, <minute>, <second>. The time is based on the 24-hour military-time clock. For example, 1 p.m. is 13:00:00. Hour displays hours from 00 to 23. Minute displays minutes from 00 to 59. Second displays seconds from 00 to 59.

### Advanced

The Advanced menu allows you to configure your system for basic operation. Some entries are defaults required by the system board, while others, if enabled, will improve the performance of your system or let you set some features according to your preference.



#### Important:

Setting incorrect field values may cause the system to malfunction.

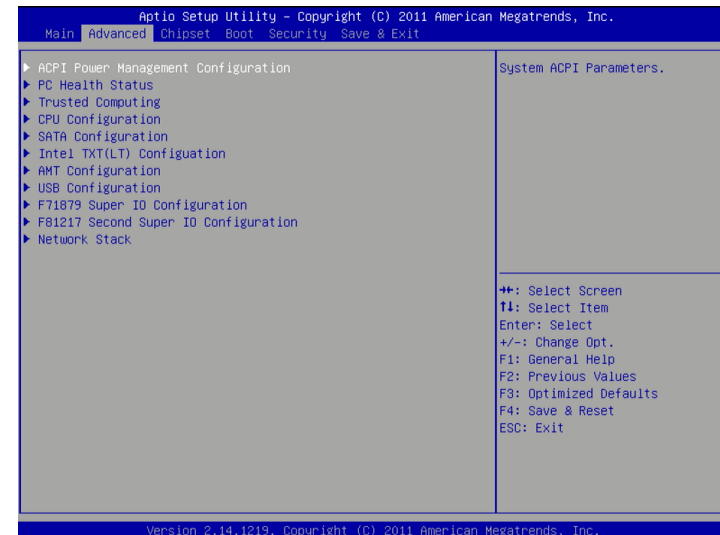

## ACPI Power Management Configuration

This section is used to configure the ACPI Power Management.

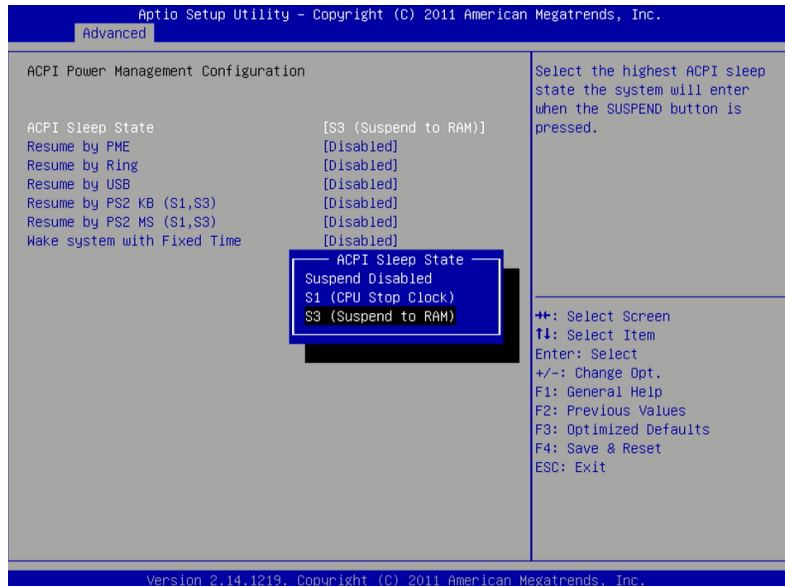

Selects the highest ACPI sleep state the system will enter when the Suspend button is pressed.

S1(POS) Enables the Power On Suspend function.

S3(STR) Enables the Suspend to RAM function.

### Resume by PME

Enable this field to use the PME signal to wake up the system.

### Resume by Ring

Enable this field to use the Ring signal to wake up the system.

### Resume by USB

Enable this field to use a USB device to wake up the system.

### Resume by PS2 KB/MS (S1, S3)

Enable this field to use the PS/2 KB/MS to wake up the system.

### Wake system with Fixed Time

Enable or disable the system wake on alarm event. When enabled, system will wake on the hr::min::sec specified.

## PC Health Status

This section displays the SIO hardware health monitor.

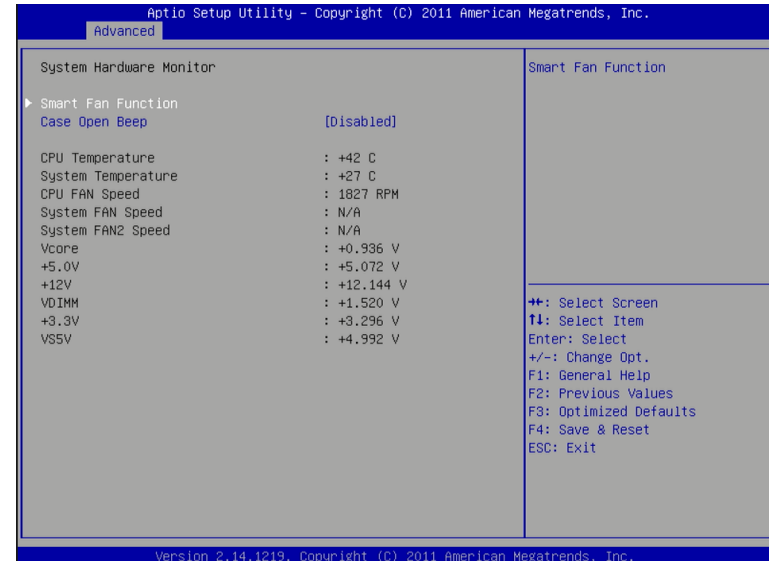

## Smart Fan Function

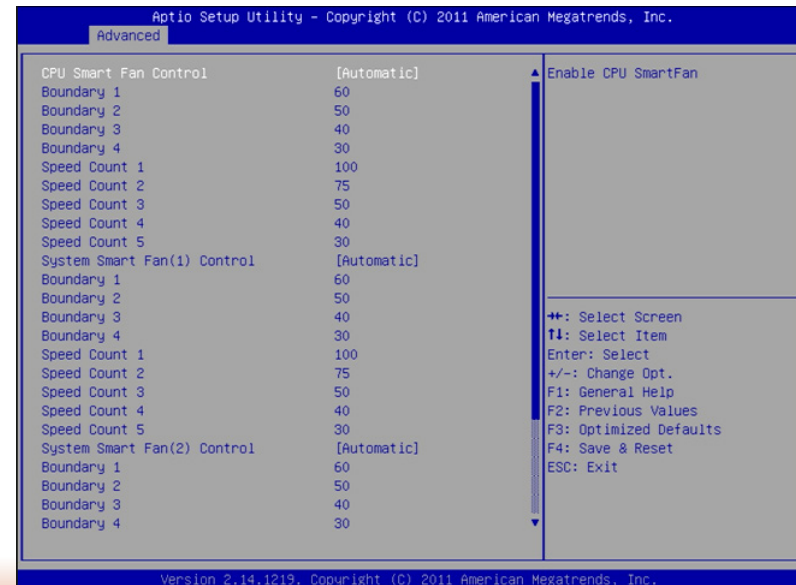

### Security Device Support

This field is used to enable or disable BIOS supporting for the security device. O.S will not show the security device. TCG EFI protocol and INT1A interface will not be available.

### CPU Smart Fan Control

When this feature is set to Automatic, the CPU's fan speed will rotate according to the CPU's temperature. The higher the temperature, the faster the speed of rotation.

Boundary 1 to Boundary 4

The range is from 0-127.

Speed Count 1 to Speed Count 5

The range is from 1-100.

Case Open Beep

Set this field to Enabled to allow the system to alert you of a chassis intrusion event.

### Trusted Computing

This section configures settings relevant to Trusted Computing innovations.



### TPM Support

This field is used to enable or disable BIOS supporting for the security device. O.S will not show the security device. TCG EFI protocol and INT1A interface will not be available.

## CPU Configuration

This section is used to configure the CPU. It will also display the detected CPU information.

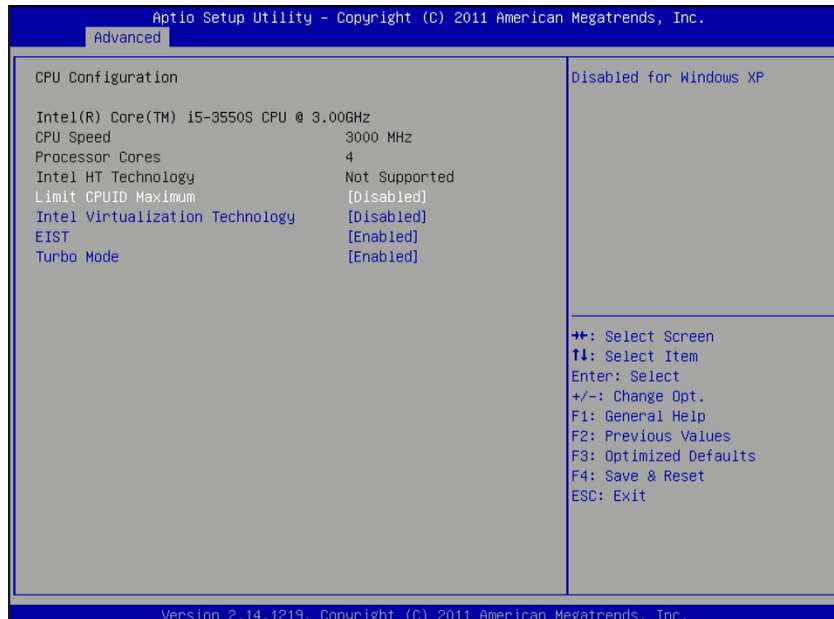

The CPUID instruction of some newer CPUs will return a value greater than 3. The default is Disabled because this problem does not exist in the Windows series operating systems. If you are using an operating system other than Windows, this problem may occur. To avoid this problem, enable this field to limit the return value to 3 or less than 3.

### Intel Virtualization Technology

When this field is set to Enabled, the VMM can utilize the additional hardware capabilities provided by Vanderpool Technology.

### EIST

This field is used to enable or disable the Intel Enhanced SpeedStep Technology.

### Turbo Mode

If you want the system to run at a faster speed, set this field to Enabled. However, compatibility problems may occur with some DRAMs if the system is running in Turbo mode. If you encounter this problem, set this field to Disabled.

## SATA Configuration

This section is used to configure the settings of SATA device.

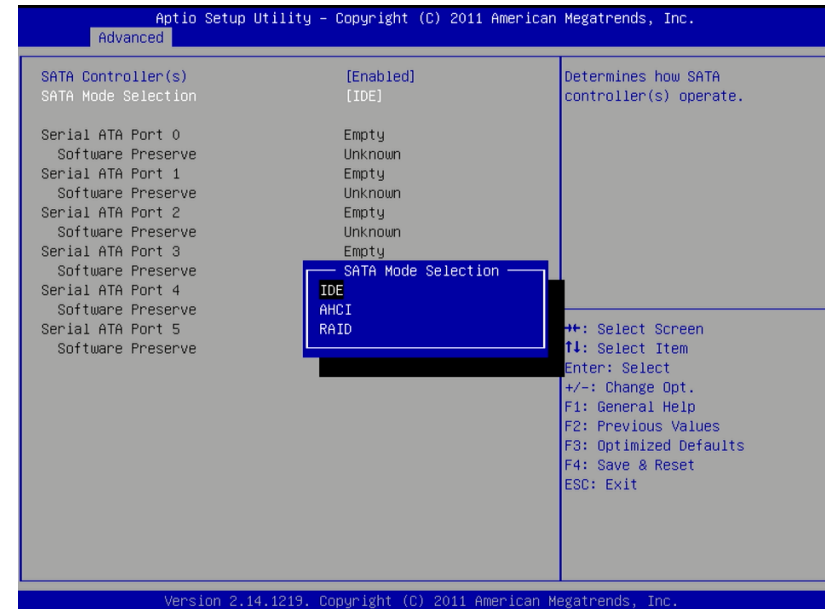

### SATA Controller(s)

This field is used to enable or disable the Serial ATA devices.

### SATA Mode Selection

The mode selection determines how the SATA controller(s) operates.

#### IDE Mode

This option configures the Serial ATA drives as Parallel ATA storage devices.

#### AHCI Mode

This option allows the Serial ATA devices to use AHCI (Advanced Host Controller Interface).

#### RAID Mode

This option allows you to create RAID or Intel Matrix Storage configuration on Serial ATA devices.

When IDE mode is selected in the SATA Mode Selection, it will display the following information:

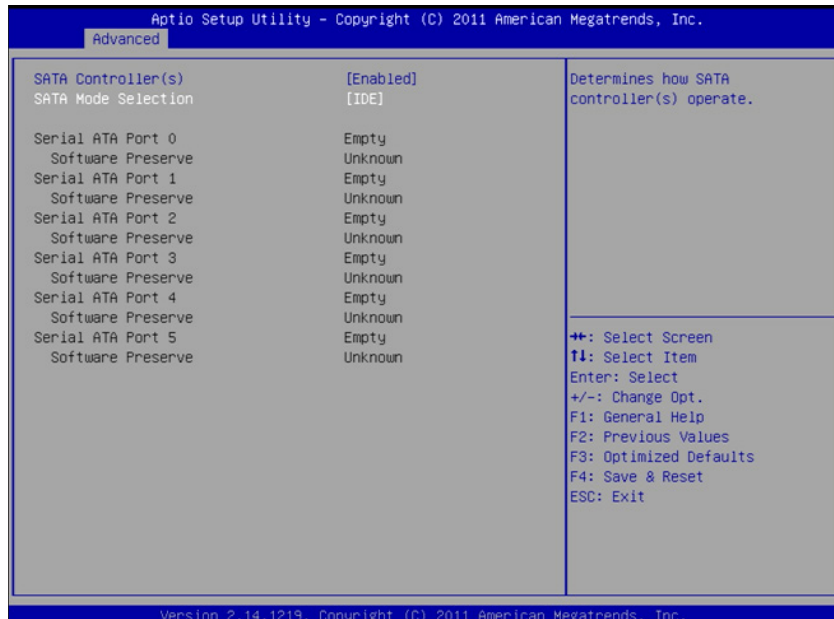

When AHCI or RAID mode is selected in the SATA Mode Selection, it will display the following information:

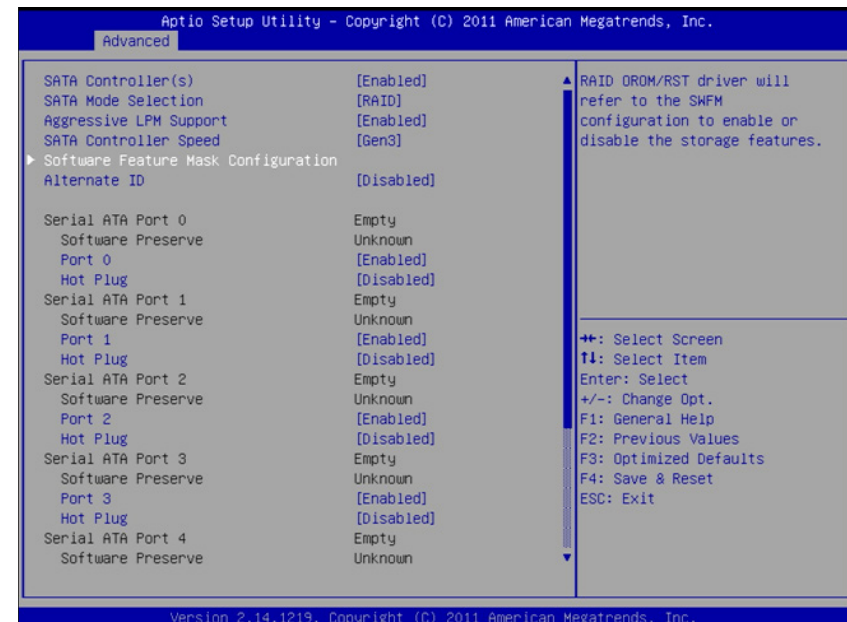

### SATA Controller(s)

Enable or Disable SATA controllers.

### SATA Controller Speed

Indicates the maximum speed that the SATA controller can support.

### Aggressive LPM Support

Enable PCH to aggressively enter link power state.

### Software Feature Mask Configuration

RAID OROM/RST driver will refer to the SWFM configuration to enable or disable the storage features.

### Alternate ID

Report alternate Device ID.

### Port 0, Port 1 and Port 4

Enables or disables the SATA port.

### Hot Plug

Designates the SATA port as hot pluggable.

### Intel TXT (LT) Configuration

This section displays the Intel Trusted Execution technology information.

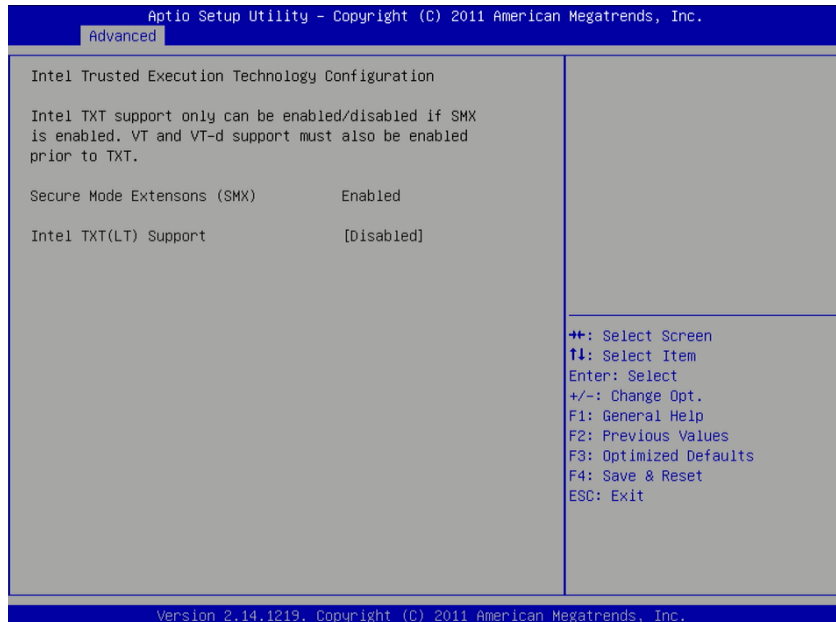

The following options are disabled:  
**Secure Mode Extensions (SMX)**  
**Intel TXT(LT) Support**

### Intel AMT Configuration

This section displays the Intel AMT technology information.

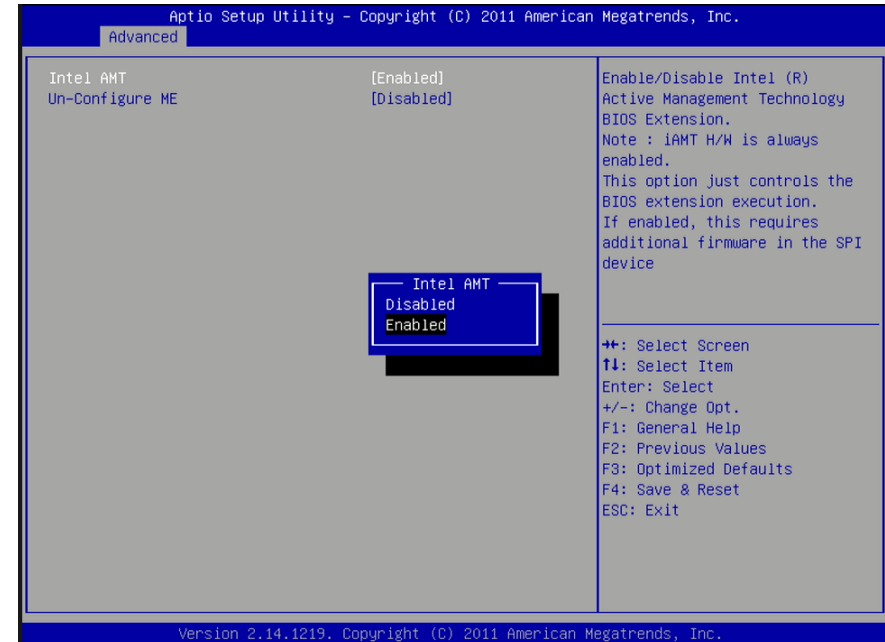

#### Intel AMT

Enables or disables the AMT function.

#### Un-Configure ME

Select Enabled to unconfigure the ME function without the need for a password.



## USB Configuration

This section is used to configure the parameters of the USB device.

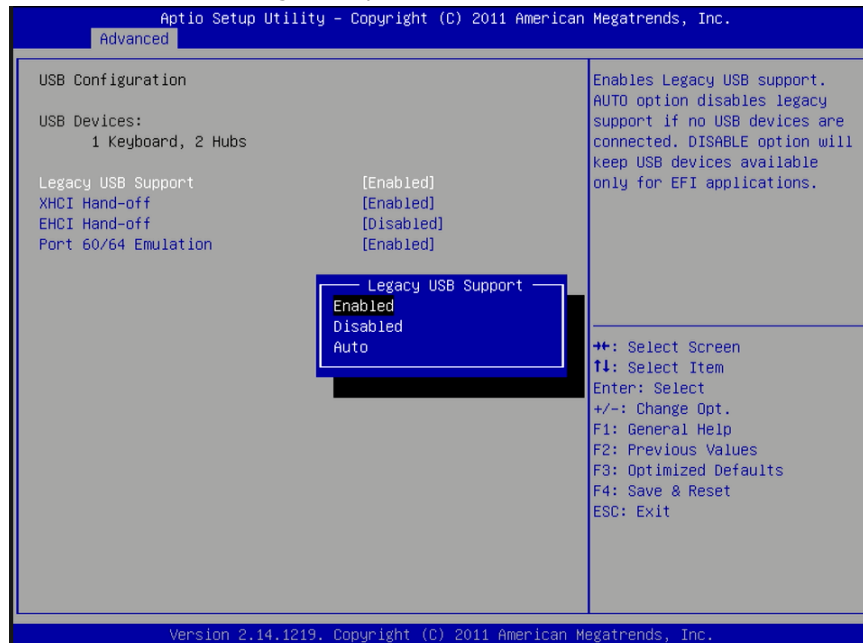

### Legacy USB Support

Enabled

Enables legacy USB.

Auto

Disables support for legacy when no USB devices are connected.

Disabled

Keeps USB devices available only for EFI applications.

### XHCI Hand-off

This is a workaround for OSEs without XHCI hand-off support. The XHCI ownership change should be claimed by XHCI driver.

### EHCI Hand-off

This is a workaround for OSEs that does not support EHCI hand-off. The EHCI ownership change should be claimed by the EHCI driver.

## Port 60/64 Emulation

Enables I/O port 60h/64h emulation support. This should be enabled for the complete USB keyboard legacy support for non-USB aware OSEs.

## Super IO Configuration

This section is used to configure the I/O functions supported by the onboard F71879 Super I/O chip.

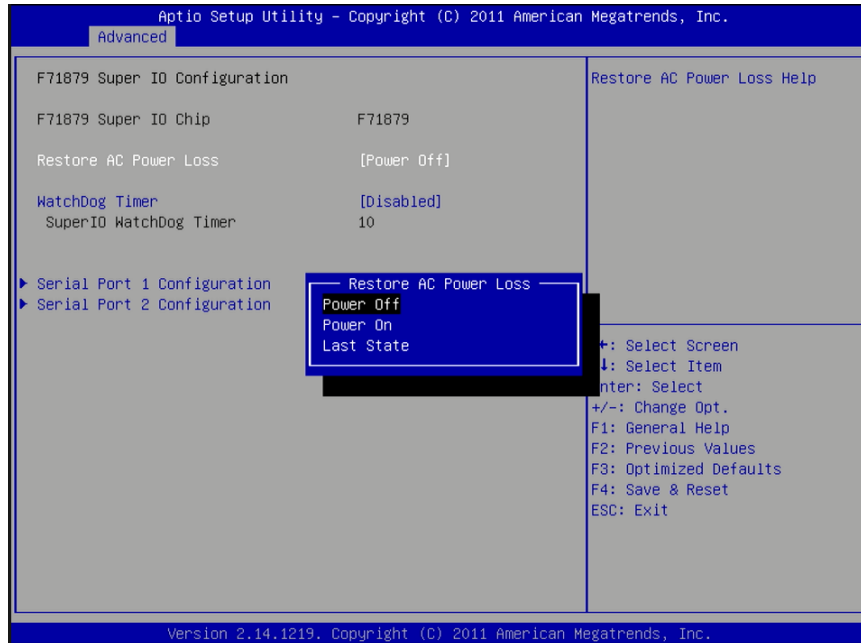

### Restore AC Power Loss

#### Power Off

When power returns after an AC power failure, the system's power is off. You must press the Power button to power-on the system.

#### Power On

When power returns after an AC power failure, the system will automatically power-on.

#### Last State

When power returns after an AC power failure, the system will return to the state where you left off before power failure occurs. If the system's power is off when AC power failure occurs, it will remain off when power returns. If the system's power is on when AC power failure occurs, the system will power-on when power returns.

### Watchdog Timer

Selects the watchdog timer unit: second or minute.

## Super IO Watchdog Timer

Sets the timeout value of the super IO watchdog timer. 0 means disabled.

## Serial Port 1 & Serial Port 2 Configuration

Sets the parameters of serial port 0 (COM A) and serial port 1 (COM B).

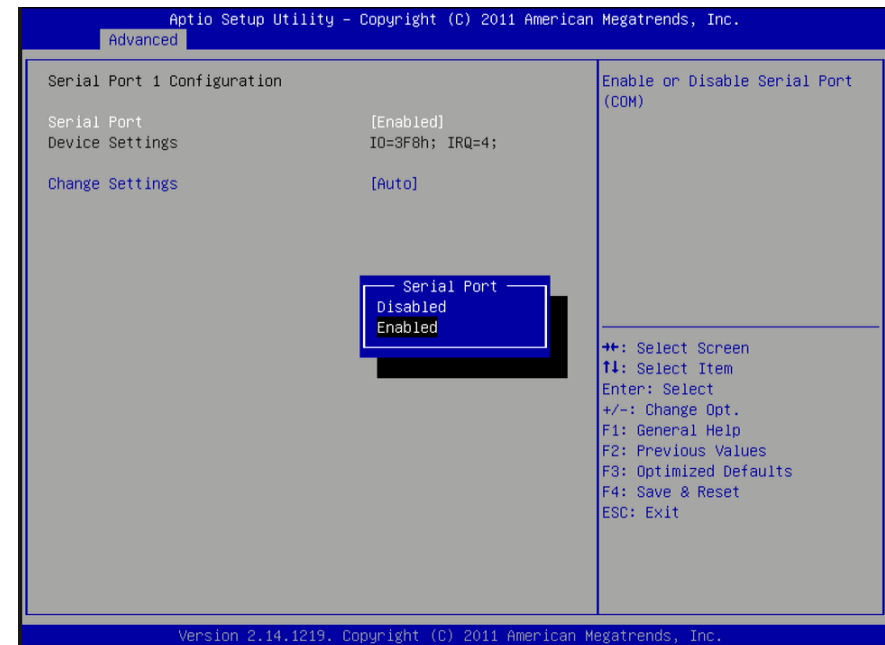

### Serial Port

Enables or disables the serial port (COM).

### Change Settings

Selects the IO/IRQ setting of the I/O device.

## Second Super IO Configuration

This section is used to configure the I/O functions supported by the onboard F81217 Super I/O chip.

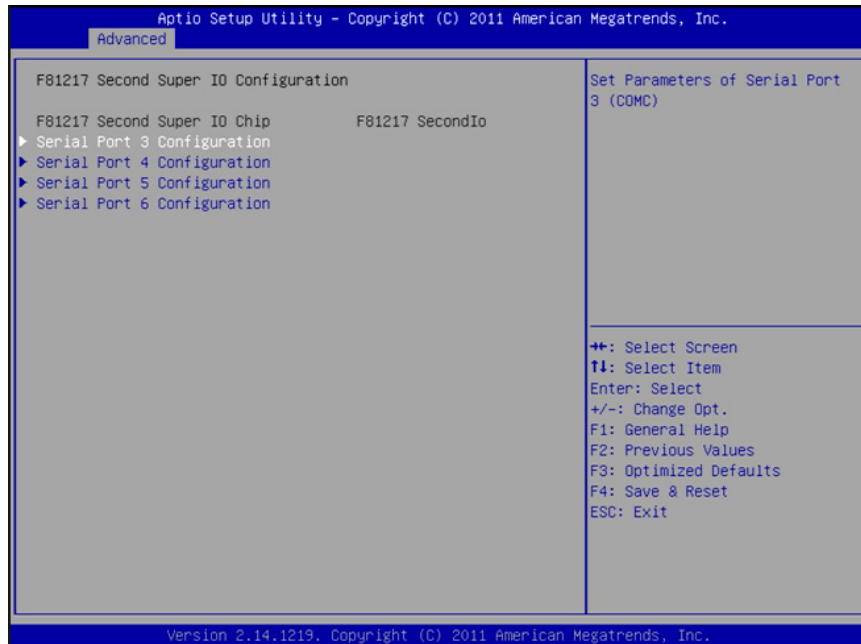

## Serial Port 3 to Serial Port 6 Configuration

### Serial Port

Enables or disables the serial port (COM).

### Change Settings

Selects the IO/IRQ setting of the I/O device.

## System Smart Fan Control

When this feature is set to Automatic, the System's fan speed will rotate according to the System's temperature. The higher the temperature, the faster the speed of rotation.

### Boundary 1 to Boundary 4

The range is 0-127.

### Speed Count 1 to Speed Count 5

The range is 1-100%.

### Case Open

Sets this field to Enabled to allow the system to alert you of a chassis intrusion event.

## Network Stack

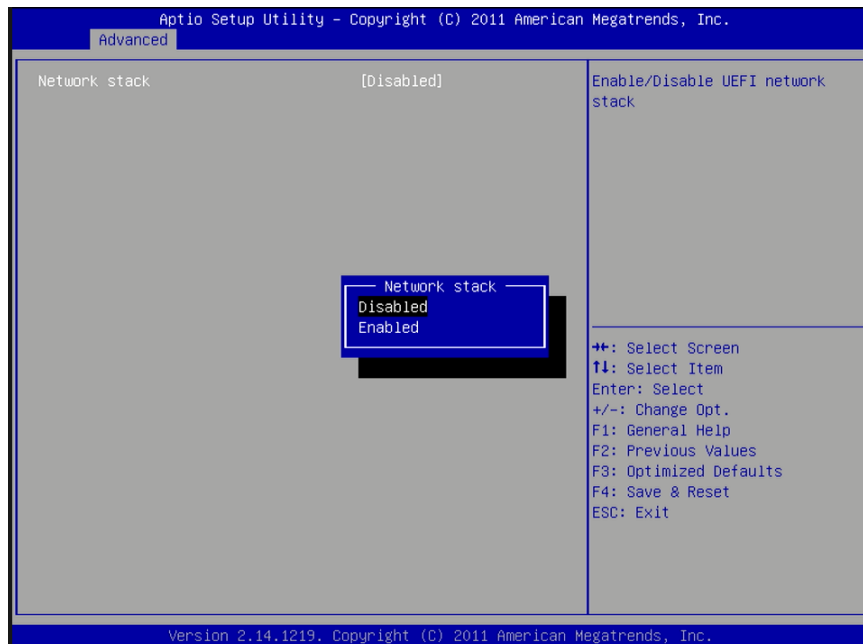

### Network Stack

Enable or disable UEFI network stack.

### Ipv4 PXE Support

When enabled, Ipv4 PXE boot is supported. When disabled, Ipv4 PXE boot option will not be created.

### Ipv6 PXE Support

When enabled, Ipv6 PXE boot is supported. When disabled, Ipv6 PXE boot option will not be created.

## Chipset

This section configures relevant chipset functions.



## South Bridge Configuration

This section is used to configure the parameters of PCH.

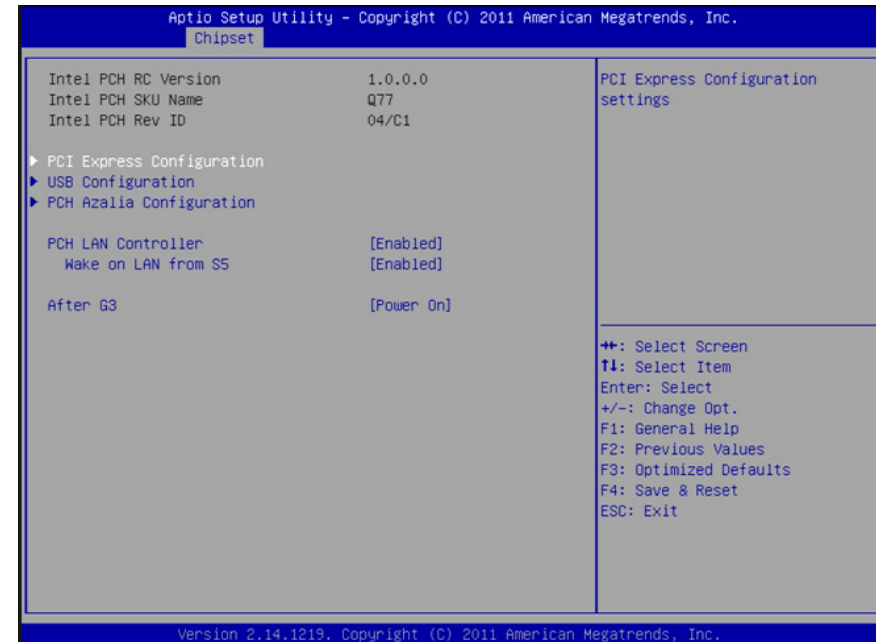

### PCH LAN Controller

Enables or disables the PCH LAN Controller.

### Wake on LAN from S5

When enabled, it allows the system to wake up from S5 via the network LAN.

### After G3

Power Off / WOL

Power-on the system via WOL after G3.

Power On

Power-on the system after G3.

### PCI Express Configuration

This field is used to configure the PCI Express settings.

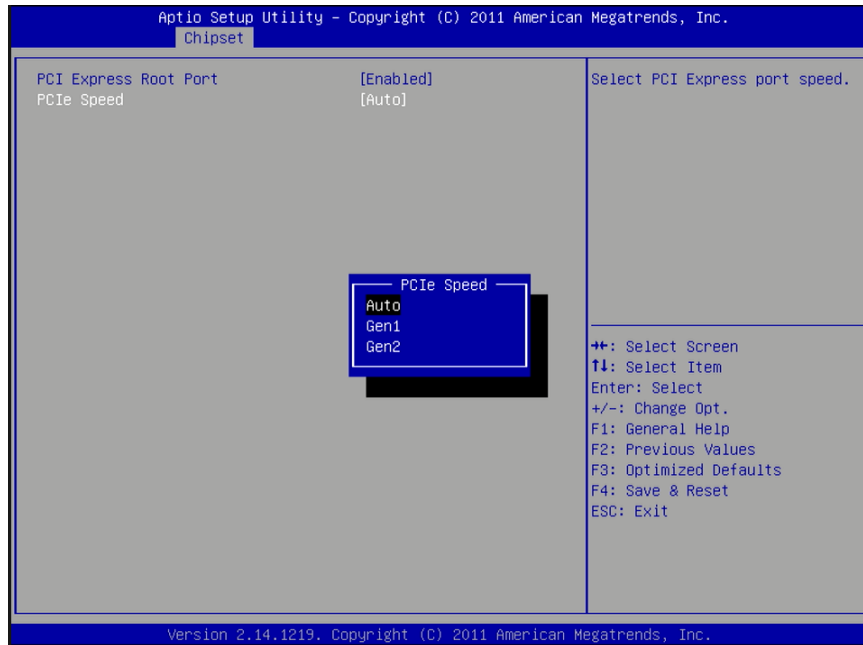

#### PCI Express Root Port 1

Controls the PCI Express Root Port.

#### PCIe Speed

Selects the speed of PCI Express port.

### PCI Express Configuration

This field is used to configure the PCI Express settings.

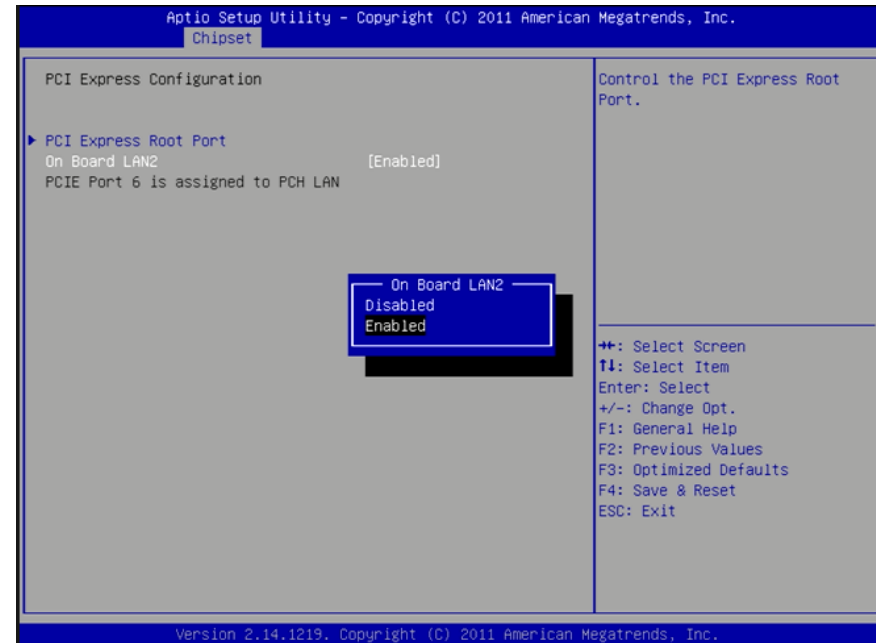

#### On Board LAN2

Enable or disable the onboard LAN.

## USB Configuration

This field is used to configure the USB settings.

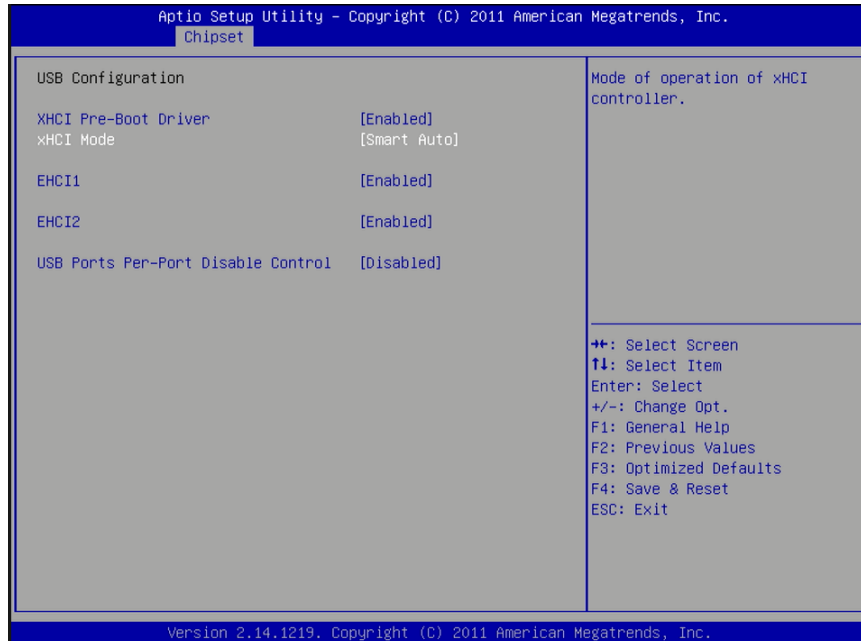

### USB Precondition

Precondition works on USB host controller and root ports for faster enumeration.

### xHCI Mode

Mode of operation of xHCI controller. Options are Smart Auto, Auto, Disabled.

### EHCI1 and EHCI2

These fields are used to enable or disable USB 2.0.

### USB Ports Per-Port Disable Control

Control each of the USB ports (0~13) disabling.

## PCH Azalia Configuration

This field is used to configure the PCH Azalia settings.

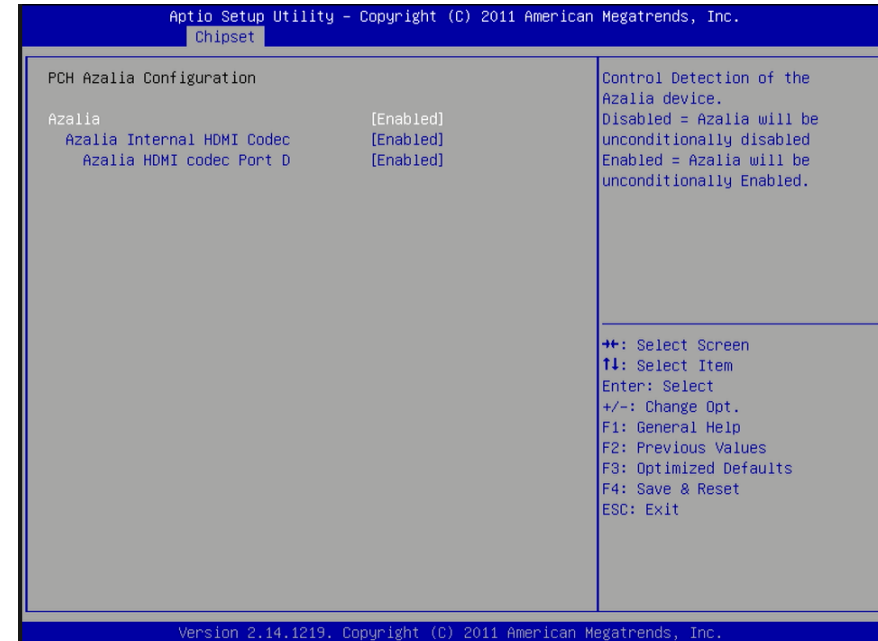

### Azalia internal HDMI codec

Enables or disables the Azalia internal HDMI codec.

## North Bridge Configuration

This section is used to configure the parameters of North Bridge.

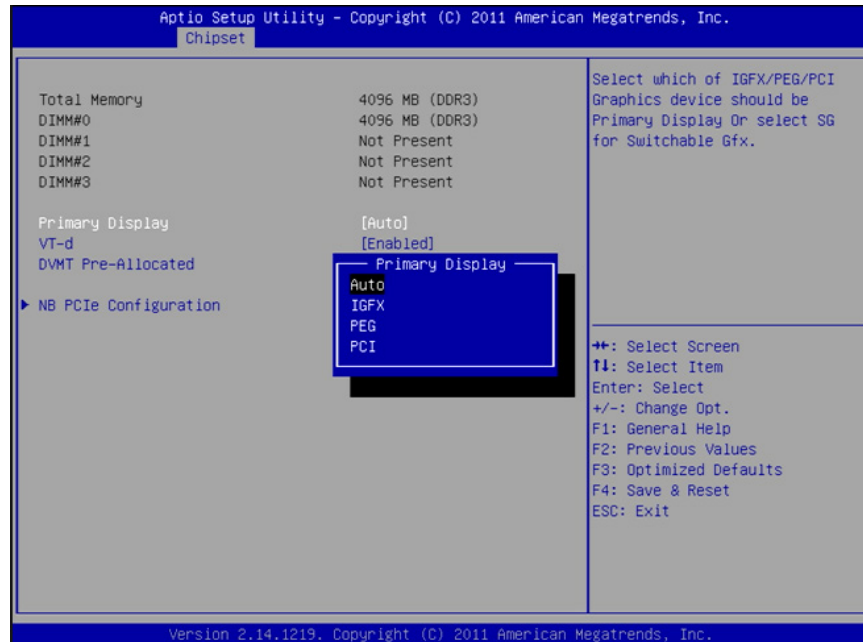

### Primary Display

**Auto** When the system boots, it will auto detects the display device.

**IGFX** When the system boots, it will first initialize the onboard VGA.

**PEG** When the system boots, it will first initialize the PCI Express x16 graphics card.

**PCI** When the system boots, it will first initialize the PCI graphic

### VT-d

Check to enable VT-d function on MCH.

### DVMT Pre-Allocated

Select DVMT 5.0 Pre-Allocated (Fixed) Graphics Memory size used by the Internal Graphics Device.

## PCI Express Configuration

This field is used to configure the PCI Express settings of the North Bridge.

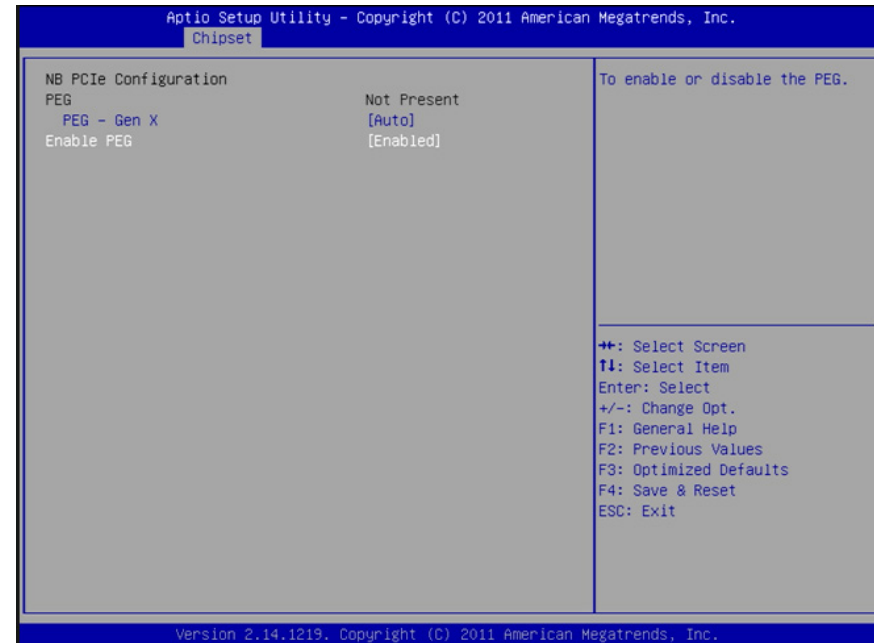

### PEG Speed

Selects the speed of the PEG.

### Enable PEG

Enable or disable the PEG.



## ME Subsystem

This field is used to configure the Intel ME firmware.

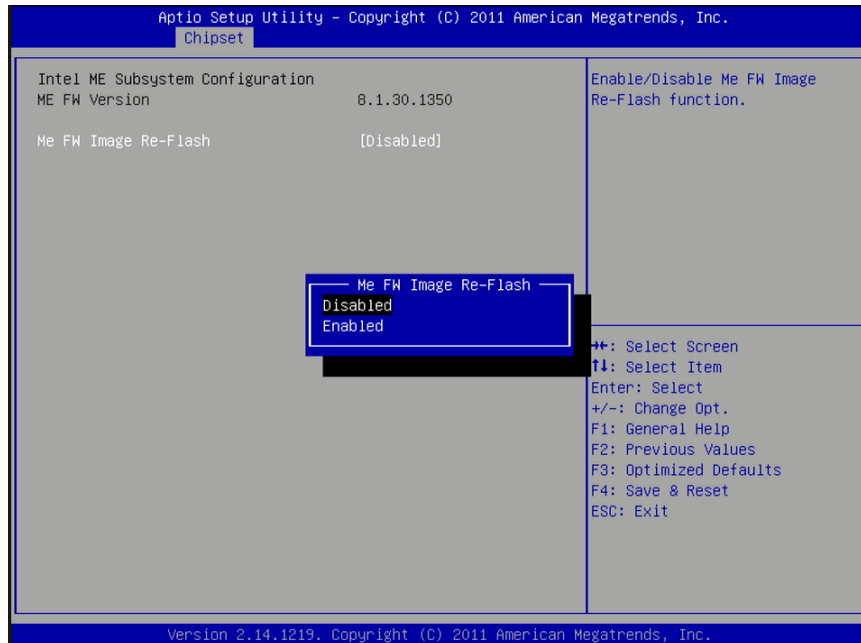

### Me firmware Image Re-Flash

Enable/Disable the firmware image re-flashing.

## Boot

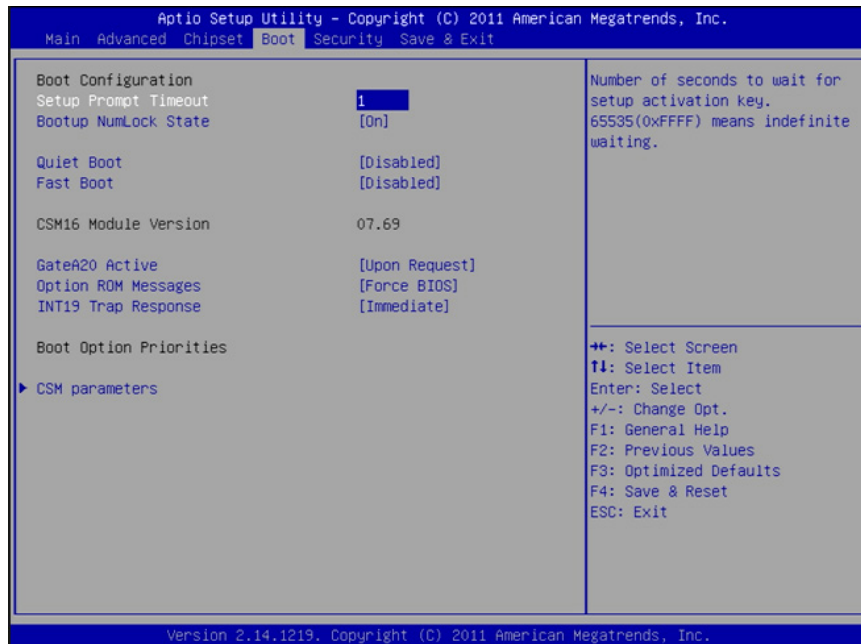

### Setup Prompt Timeout

Selects the number of seconds to wait for the setup activation key. 65535(0xFFFF) denotes indefinite waiting.

### Bootup NumLock State

This allows you to determine the default state of the numeric keypad. By default, the system boots up with NumLock on wherein the function of the numeric keypad is the number keys. When set to Off, the function of the numeric keypad is the arrow keys.

### Quiet Boot

Enables or disables the quiet boot function.

### Fast Boot

Enables or disables boot with initialization of a minimal set of devices required to launch active boot option. Has no effect for BBS boot options.

### GateA20 Active

Upon Request- GA20 can be disabled using BIOS services.

Always- Do not allow disabling GA20; this option is useful when any RT code is executed above 1MB.

### Option ROM Messages

Set display mode for option ROM.

### Int19 Trap Response

BIOS reaction on Int19 trapping by option ROM.

## CSM Parameters

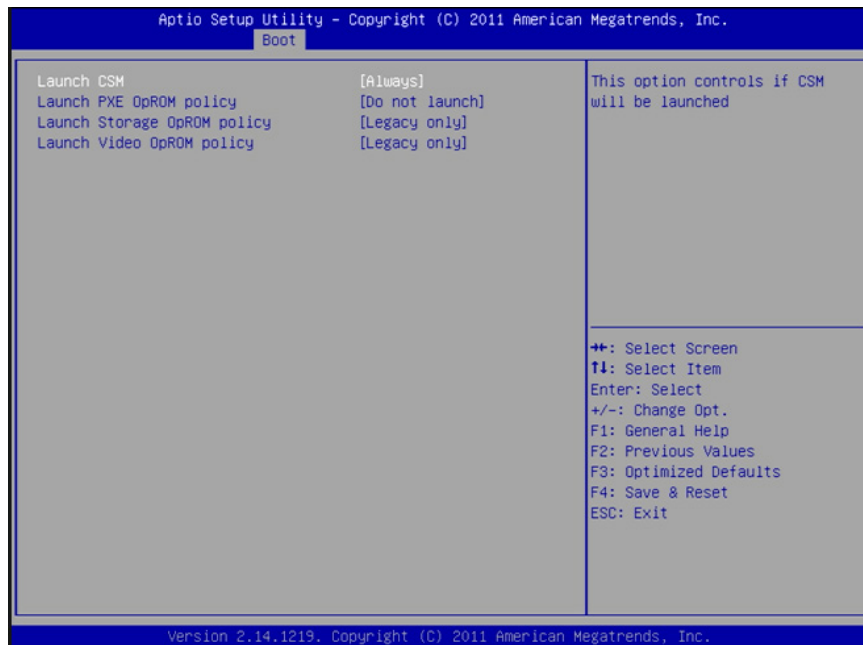

### Launch CSM

This option controls if CSM will be launched.

### Launch PXE OpROM policy

Controls the execution of UEFI and legacy PXE OpROM.

### Launch Storage OpROM policy

Controls the execution of UEFI and legacy storage OpROM.

### Launch Video OpROM policy

Controls the execution of UEFI and legacy video OpROM.

## Security

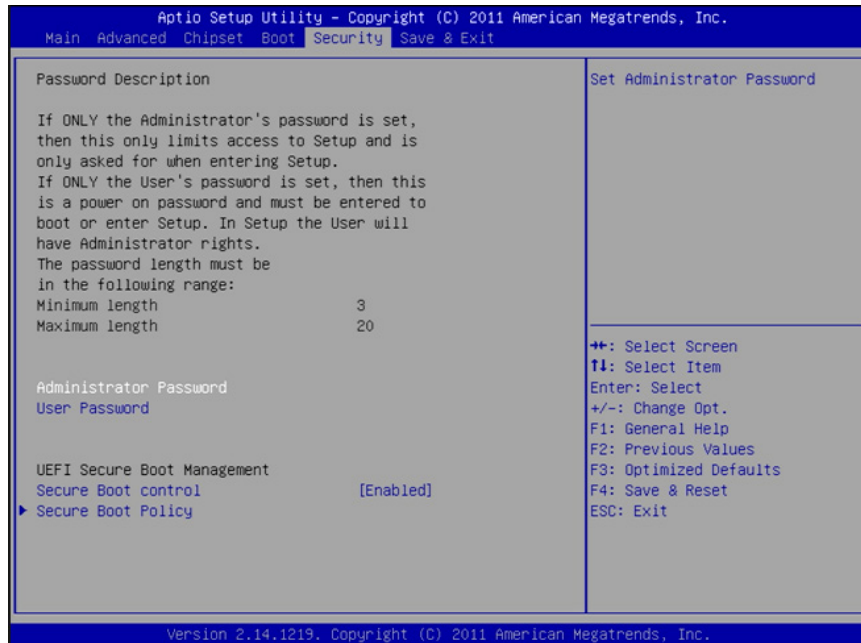

### Administrator Password

Sets the administrator's password.

### User Password

Sets the user's password.

### Secure Boot Control

Secure boot flow control. Secure boot is possible only if system runs in User Mode.

## Secure Boot Policy

This screen sets the Image Execution Policy on Security Violation. It configures permission/denial of different kind of Images when secure boot is enabled.



### Internal FV

The option is Always Execute.

### Option ROM

The options are Always Execute, Always Deny, Allow Execute, Defer Execute, Deny Execute, and Query User.

### Removable Media

The options are Always Execute, Always Deny, Allow Execute, Defer Execute, Deny Execute, and Query User.

### Fixed Media

The options are Always Execute, Always Deny, Allow Execute, Defer Execute, Deny Execute, and Query User.

## Save & Exit

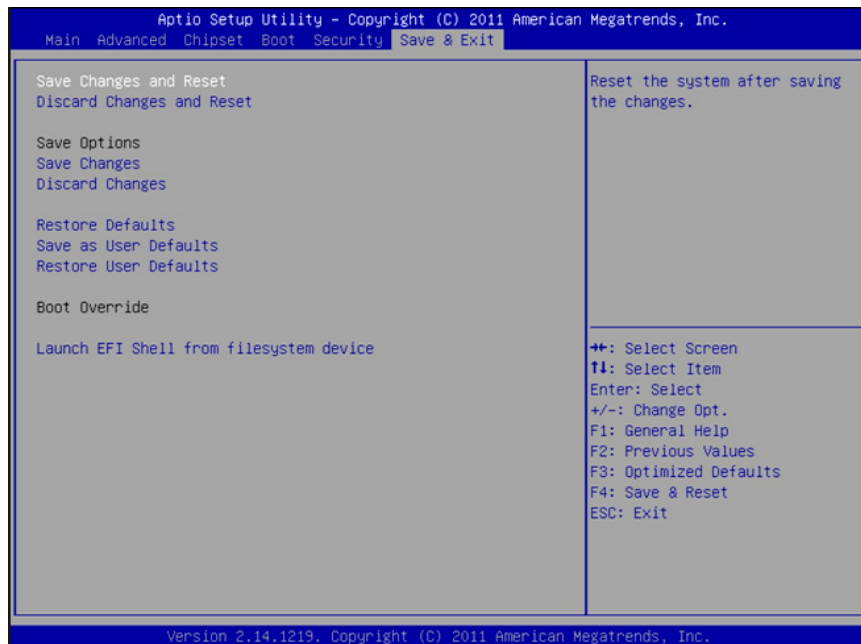

### Save Changes and Reset

To save the changes, select this field and then press <Enter>. A dialog box will appear. Select Yes to reset the system after saving all changes made.

### Discard Changes and Reset

To discard the changes, select this field and then press <Enter>. A dialog box will appear. Select Yes to reset the system setup without saving any changes.

### Save Changes

Save changes done so far to any of the setup options.

### Discard Changes

Discard changes done so far to any of the setup options.

### Restore Defaults

To restore and load the optimized default values, select this field and then press <Enter>. A dialog box will appear. Select Yes to restore the default values of all the setup options.

### Save as User Defaults

To save changes done so far as user default, select this field and then press <Enter>. A dialog box will appear. Select Yes to save values as user default.

### Restore User Defaults

To restore user default to all the setup options, select this field and then press <Enter>. A dialog box will appear. Select Yes to restore user default.

### Launch EFI Shell from filesystem device

It attempts to launch an EFI shell application (shellx64.efi) from one of the available file system devices.

## AMI BIOS Setup Utility (MB331-CRM)

### Main

The Main menu is the first screen that you will see when you enter the BIOS Setup Utility.

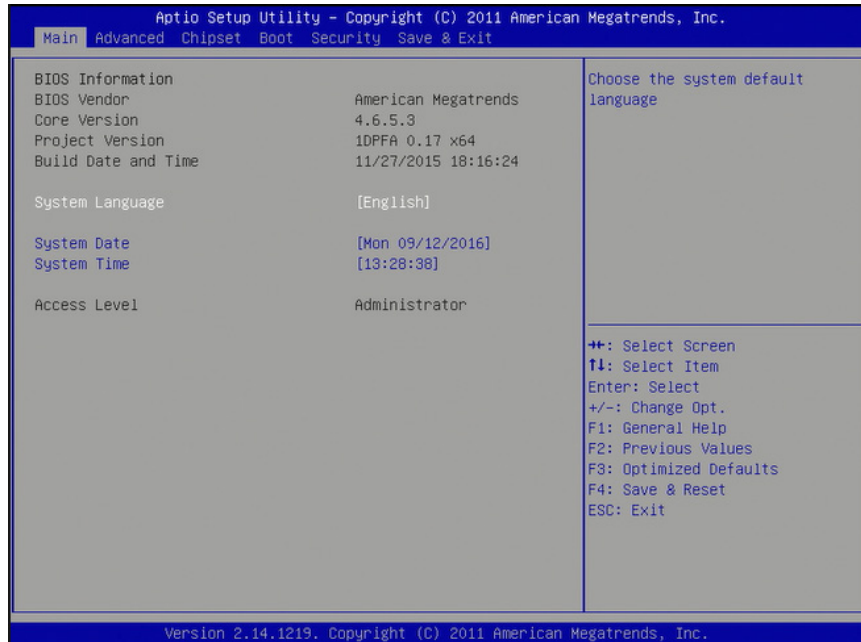

#### System Date

The date format is <day>, <month>, <date>, <year>. Day displays a day, from Sunday to Saturday. Month displays the month, from January to December. Date displays the date, from 1 to 31. Year displays the year, from 1980 to 2099.

#### System Time

The time format is <hour>, <minute>, <second>. The time is based on the 24-hour military-time clock. For example, 1 p.m. is 13:00:00. Hour displays hours from 00 to 23. Minute displays minutes from 00 to 59. Second displays seconds from 00 to 59.

### Advanced

The Advanced menu allows you to configure your system for basic operation. Some entries are defaults required by the system board, while others, if enabled, will improve the performance of your system or let you set some features according to your preference.



#### Important:

Setting incorrect field values may cause the system to malfunction.

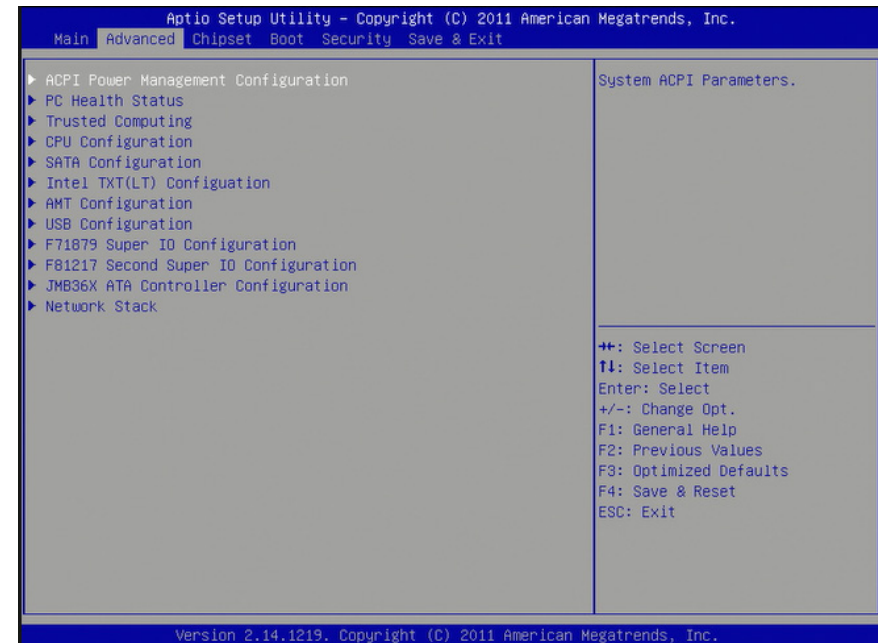

## ACPI Power Management Configuration

This section is used to configure the ACPI Power Management.

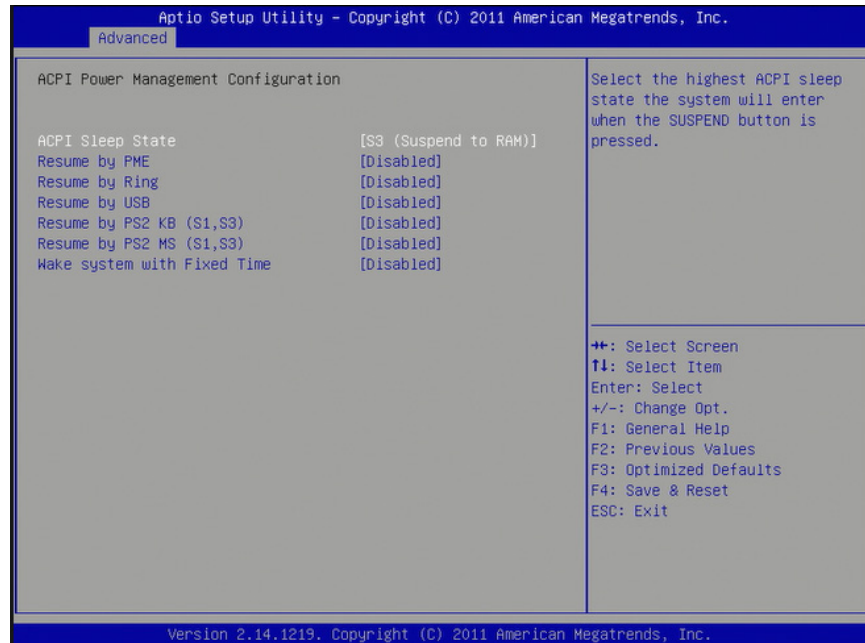

### ACPI Sleep State

Selects the highest ACPI sleep state the system will enter when the Suspend button is pressed.

**S1(POS) Enables the Power On Suspend function.**

**S3(STR) Enables the Suspend to RAM function.**

### Resume by PME

Enable this field to use the PME signal to wake up the system.

### Resume by Ring

Set this field to Enabled to use the modem ring-on function. This will allow your system to power-on to respond to calls coming through an external or internal modem.

### Resume by USB

About resume by USB; Options are enabled or disabled.

### Resume by PS2 KB (S1, S3)

About resume by PS2 keyboard (S1, S3); Options are enabled or disabled.

### Resume by PS2 MS (S1, S3)

About resume by PS2 mouse (S1, S3); Options are enabled or disabled.

### Wake system with Fixed Time

Enable or disable the system wake on alarm event. When enabled, system will wake on the hr::min::sec specified.

## PC Health Status

This section displays the SIO hardware health monitor information.

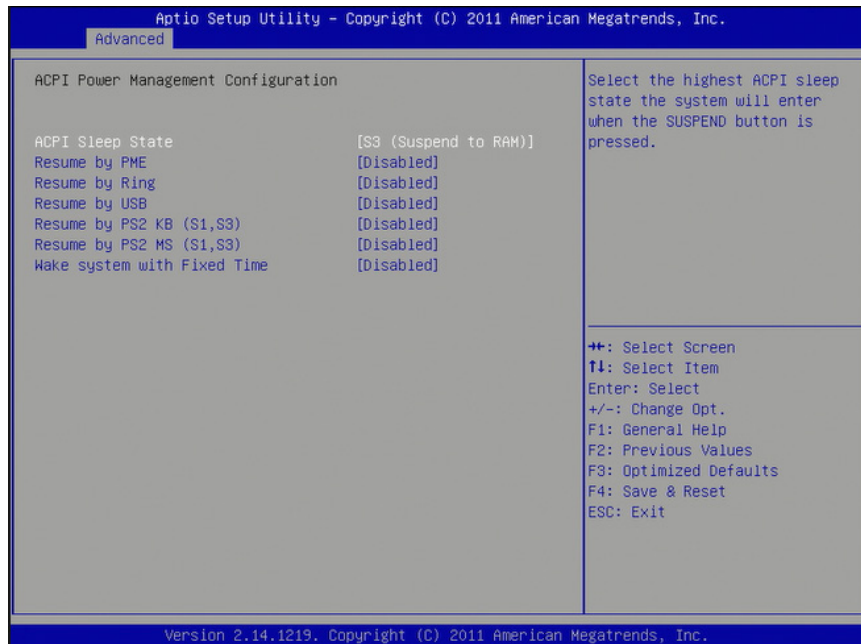

## Smart Fan Function

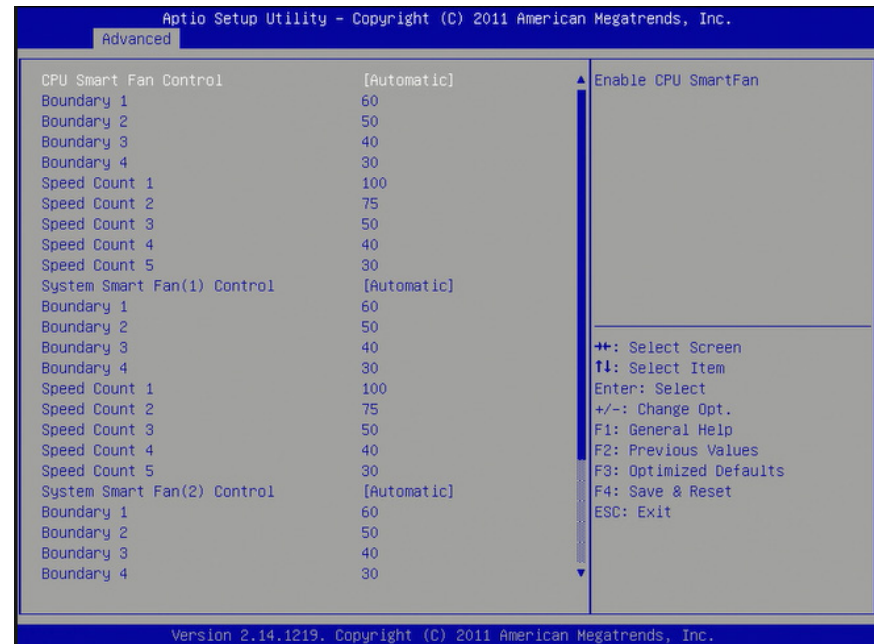

### CPU Smart Fan/System Smart Fan (1)/System Smart Fan (2) Control

When this feature is set to Automatic, the CPU fan speed will rotate according to the CPU's (or system) temperature. The higher the temperature, the faster the speed of rotation.

#### Boundary 1 to Boundary 4

The range is from 0-127.

#### Speed Count 1 to Speed Count 5

The range is from 1-100.

### Case Open Beep

Set this field to Enabled to allow the system to alert you of a chassis intrusion event.



## Trusted Computing

This section configures settings relevant to Trusted Computing innovations.

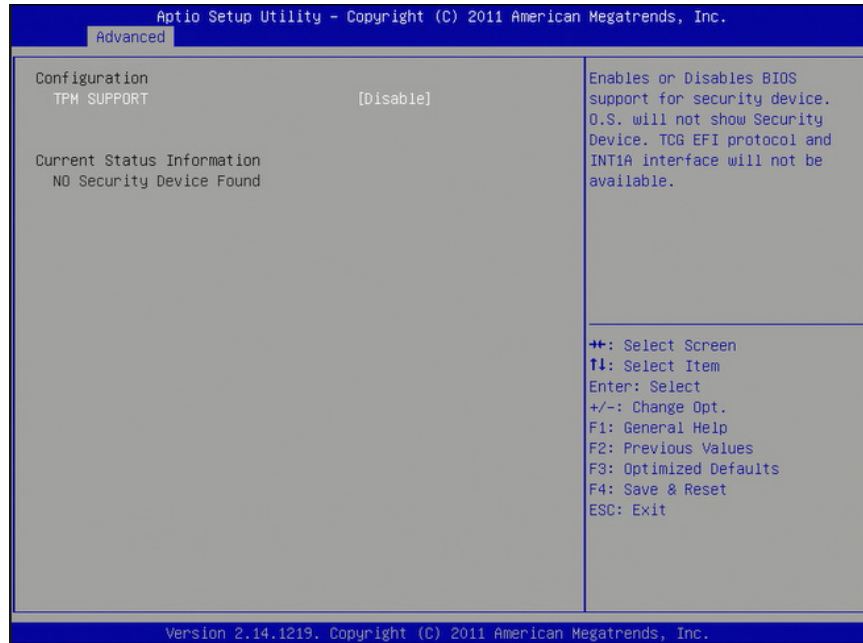

### TPM Support

Enables or Disables TPM. Resetting the platform is required for the O.S. to show TPM.

## CPU Configuration

This section is used to configure the CPU. It will also display the detected CPU information.

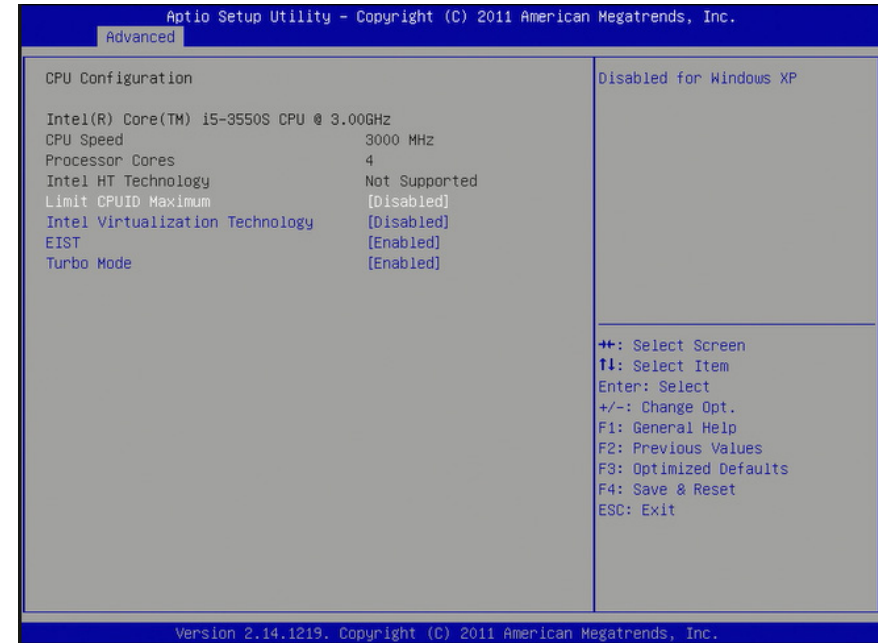

### Limit CPUID Maximum

The CPUID instruction of some newer CPUs will return a value greater than 3. The default is Disabled because this problem does not exist in the Windows series operating systems. If you are using an operating system other than Windows, this problem may occur. To avoid this problem, enable this field to limit the return value to 3 or less than 3.

### Intel Virtualization Technology

When this field is set to Enabled, the VMM can utilize the additional hardware capabilities provided by Vanderpool Technology.

### EIST

Enable or disable Intel Speedstep.

### Turbo Mode

If you want the system to run at a faster speed, set this field to Enabled. However, compatibility problems may occur with some DRAMs if the system is running in Turbo mode. If you encounter this problem, set this field to Disabled.

## SATA Configuration

This section is used to configure SATA functions.

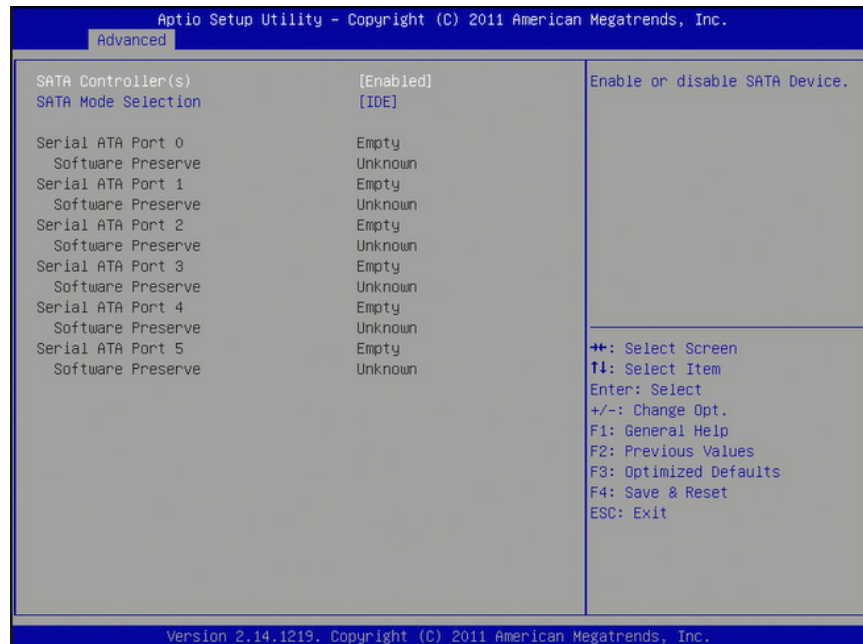

### SATA Controller(s)

This field is used to enable or disable the Serial ATA channels.

### SATA Mode Selection

#### IDE Mode

This option configures the Serial ATA drives as Parallel ATA storage devices.

#### AHCI Mode

This option allows the Serial ATA devices to use AHCI (Advanced Host Controller Interface).

#### RAID Mode

This option allows you to create RAID or Intel Matrix Storage configuration on Serial ATA devices.

If AHCI or RAID is selected in the SATA Mode Selection, it will display the following information:

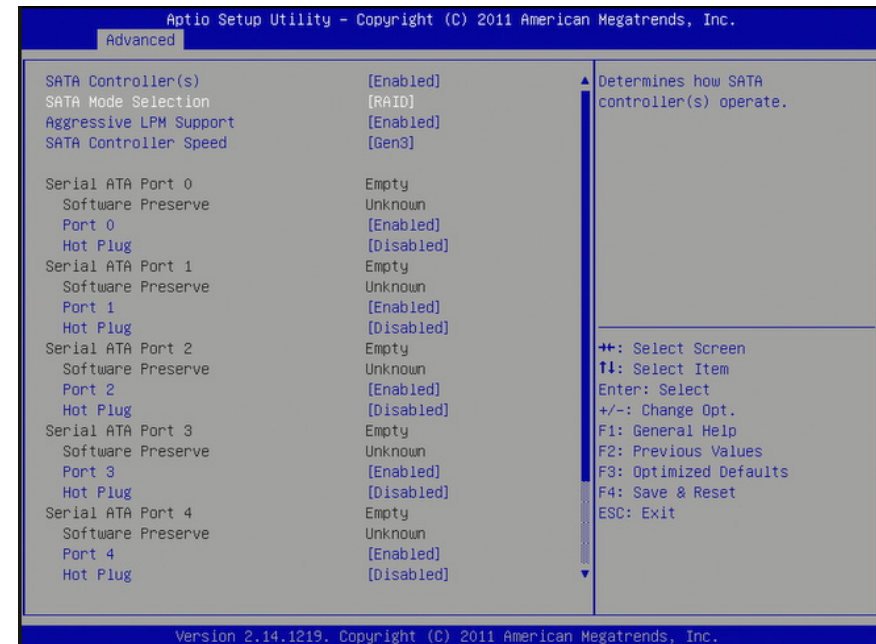

### SATA Controller(s)

This field is used to enable or disable the Serial ATA channels.

### SATA Controller Speed

Indicates the maximum speed that the SATA controller can support.

### Aggressive LPM Support

Enable PCH to aggressively enter link power state.

### Serial ATA Port 0 to Serial ATA Port 5

These fields are used to configure the connected SATA devices.

### Hot Plug

Designates the SATA port as hot pluggable.

## Intel TXT (LT) Configuration

This section is used to configure the Intel Trusted Execution technology.

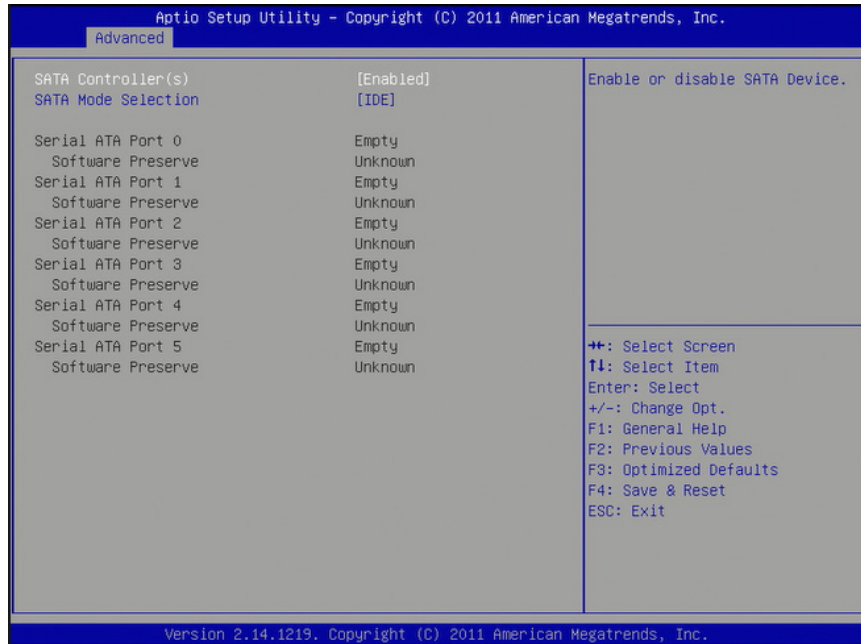

The following options are disabled:

### Secure Mode Extensions (SMX)

### Intel TXT(LT) Support

## Intel AMT Configuration

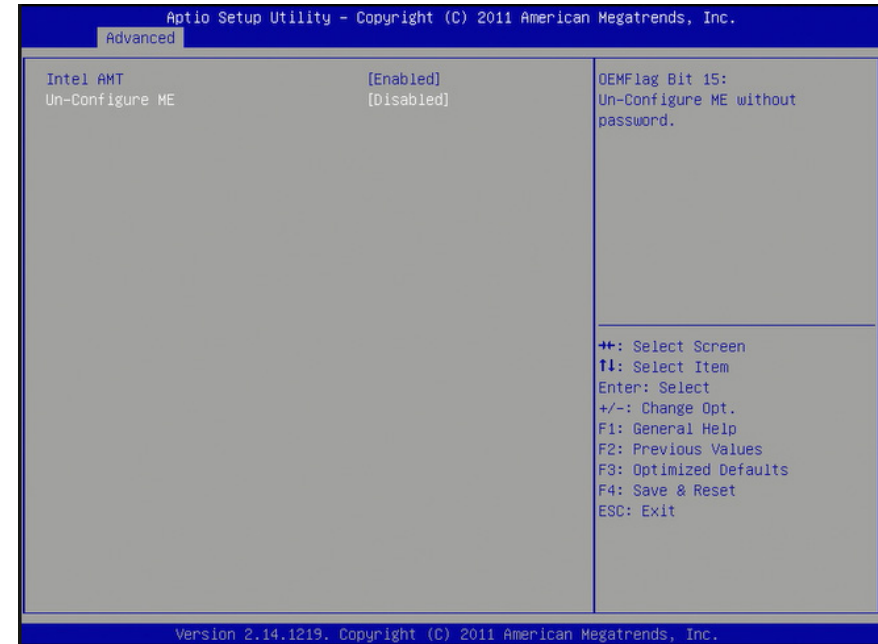

### Intel AMT

Enables or disables the AMT function.

### Un-Configure ME

Select Enabled to unconfigure the ME function without the need for a password.

## USB Configuration

This section is used to configure USB.

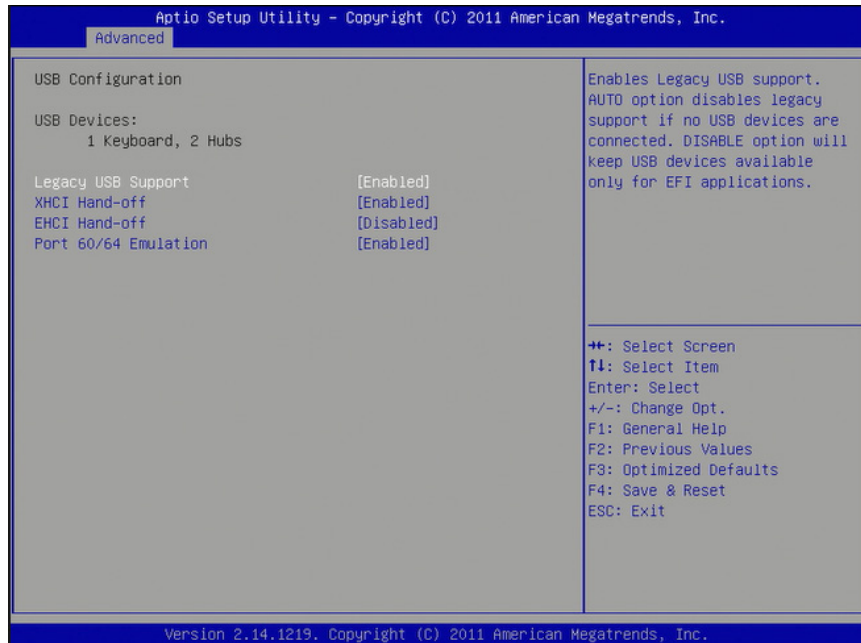

### Legacy USB Support

#### Enabled

Enable legacy USB.

#### Auto

Disable support for legacy when no USB devices are connected.

#### Disabled

Keep USB devices available only for EFI applications.

### XHCI Hand-off

This is a workaround for OSes that does not support XHCI hand-off. The XHCI ownership change should be claimed by the XHCI driver.

### EHCI Hand-off

This is a workaround for OSes that does not support EHCI hand-off. The EHCI ownership change should be claimed by the EHCI driver.

## Port 60/64 Emulation

Enables I/O port 60h/64h emulation support. This should be enabled for the complete USB keyboard legacy support for non-USB aware OSes.

## Super IO Configuration

This section is used to configure the I/O functions supported by the onboard F71879 Super I/O chip.

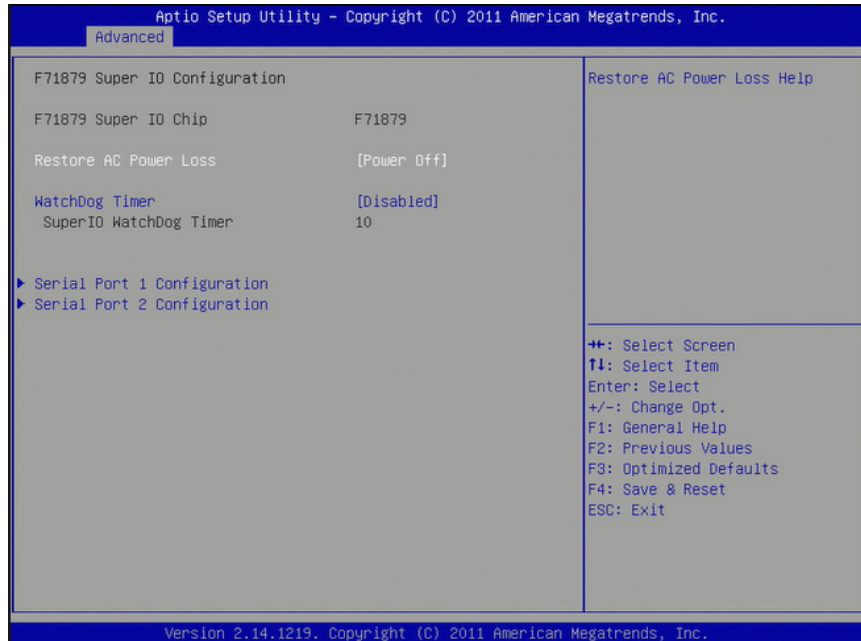

### Restore AC Power Loss

#### Off

When power returns after an AC power failure, the system's power is off. You must press the Power button to power-on the system.

#### On

When power returns after an AC power failure, the system will automatically power-on.

#### Last State

When power returns after an AC power failure, the system will return to the state where you left off before power failure occurs. If the system's power is off when AC power failure occurs, it will remain off when power returns. If the system's power is on when AC power failure occurs, the system will power-on when power returns.

### Watchdog Timer

Enable or disable Super I/O watchdog timer.

## Serial Port 1 & Serial Port 2 Configuration

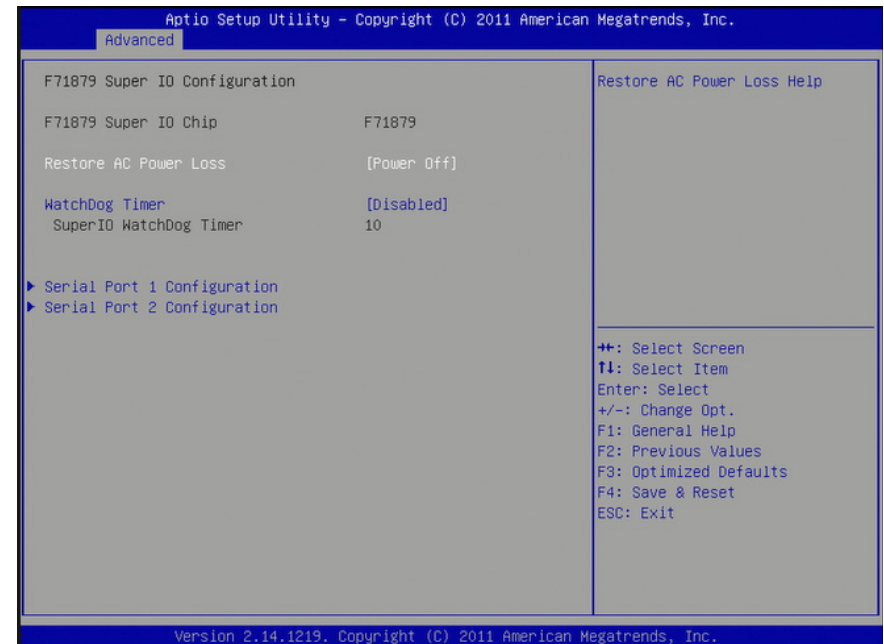

### Serial Port

Enable or disable the serial port.

### Change Settings

Select the IO/IRQ setting of the I/O device.

### F81217 Second Super IO Configuration

This section is used to configure the serial port functions.

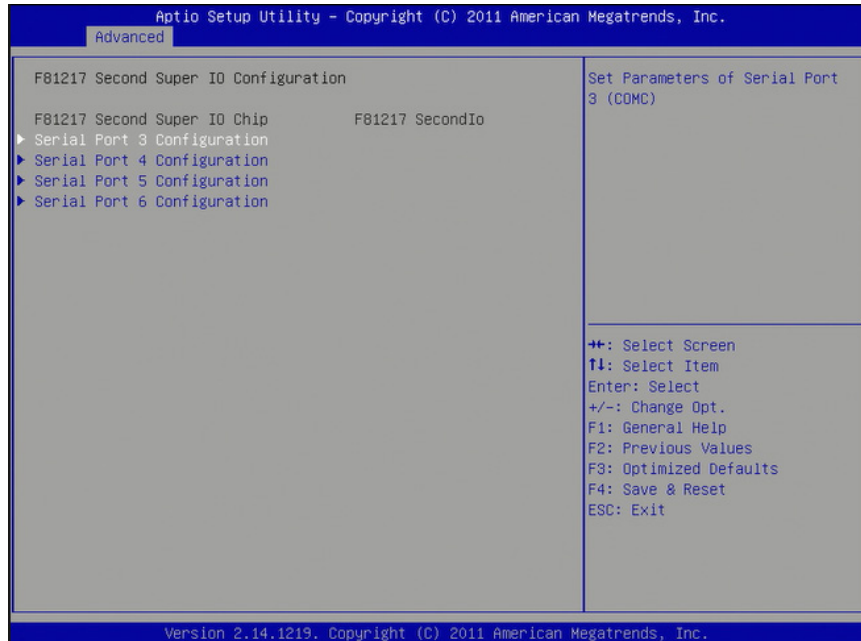

#### Serial Port 3 Configuration to Serial Port 6 Configuration

##### Serial Port

Enables or disables the serial port.

##### Change Settings

Selects the IO/IRQ setting of the I/O device.

### JMB36X ATA Controller Configuration

This section is used to configure the JMB36X ATA storage controller.

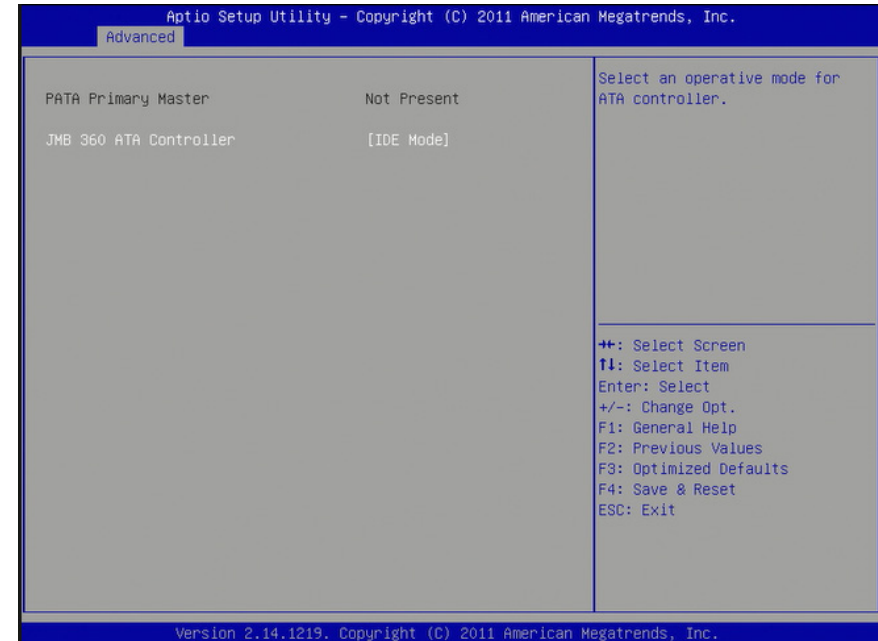

#### JMB 360 ATA Controller

Enable the IDE mode or disable the ATA controller.

## Network Stack

This section is used to configure the network stack settings.

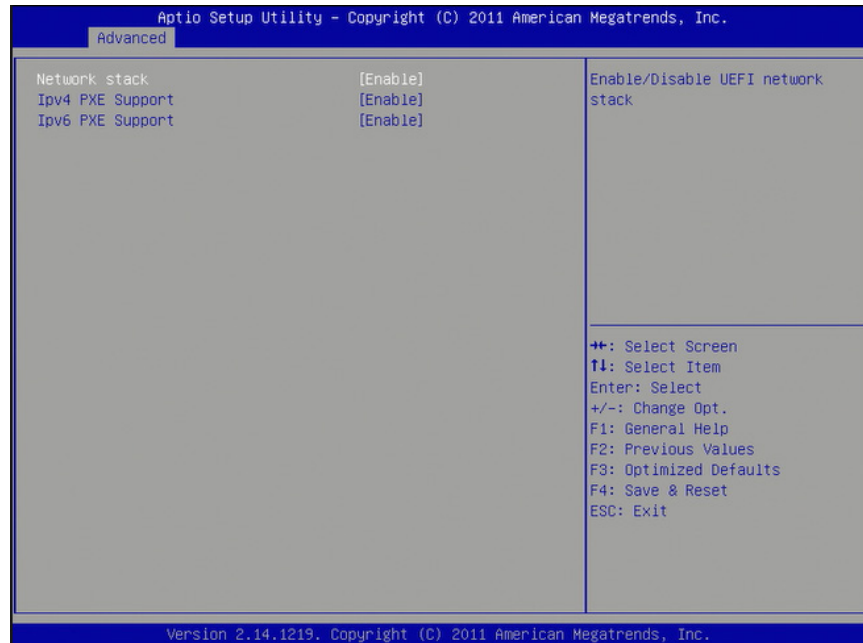

### Network Stack

Enable or disable UEFI network stack.

### Ipv4 PXE Support

When enabled, Ipv4 PXE boot is supported. When disabled, Ipv4 PXE boot option will not be created.

### Ipv6 PXE Support

When enabled, Ipv6 PXE boot is supported. When disabled, Ipv6 PXE boot option will not be created.

## South Bridge

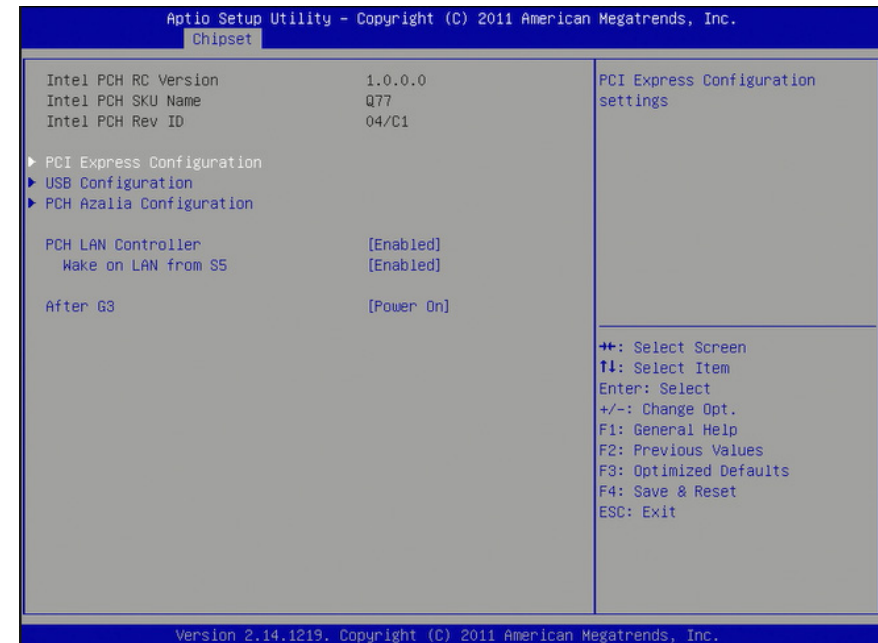

### PCH LAN Controller

Enable or disable the PCH LAN Controller.

### Wake on LAN from S5

Set this field to Enabled to wake up the system via the onboard LAN or via a LAN card that supports the remote wake up function.

### After G3

#### Power Off / WOL

Power-on the system via WOL after G3.

#### Power On

Power-on the system after G3.

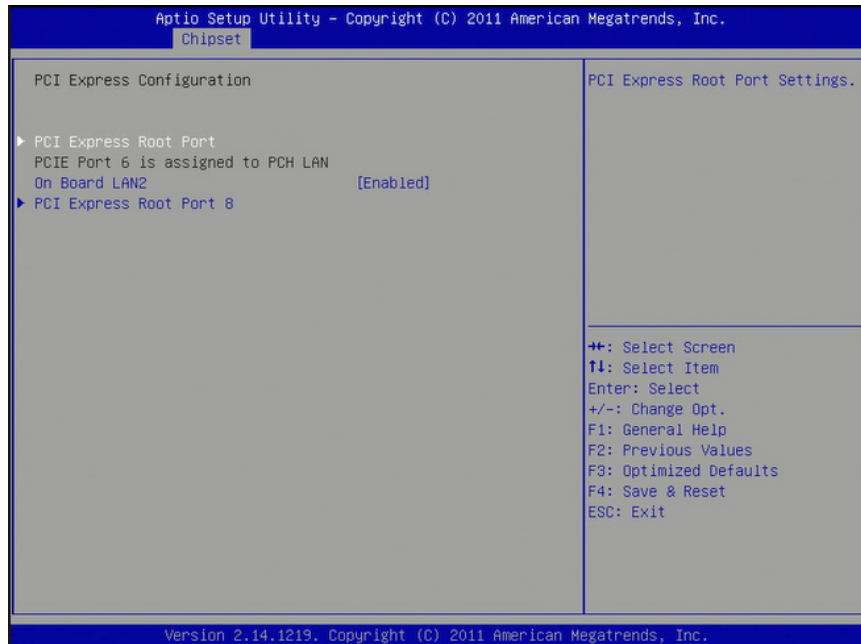

**PCI Express Configuration****PCI Express Root Port**

Enable or disable the PCIe root port.

**PCIe Speed**

Select the speed of the PCIe root port.

**On Board LAN2**

Enable or disable the onboard LAN.

**PCI Express Root Port 8**

It configures the PCIe Root Port 8 settings.

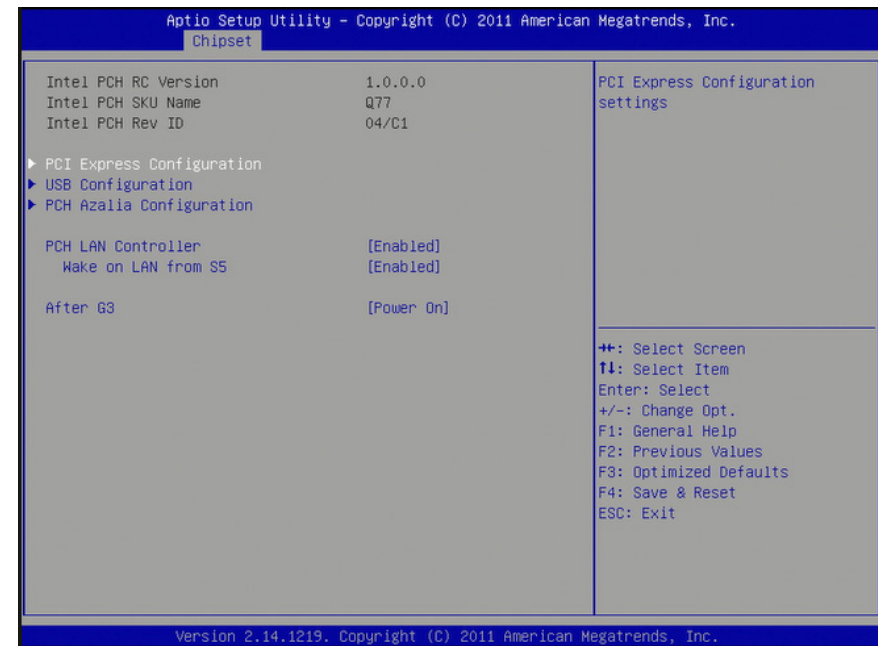
**PCI Express Root Port 8**

Enable or disable the PCIe root port 8.

**ASPM Support**

Set the ASPM level.

**UBP**

Enable or disable PCIe unsupported Requested Reporting.

**FER**

Enable or disable PCIe device fatal error reporting.

**NFER**

Enable or disable PCIe device non-fatal error reporting.

**CER**

Enable or disable PCIe device correctable error reporting.

**CTO**



Enable or disable PCIe device completion timer to.

#### SEFE

Enable or disable root PCIe system error on fatal error.

#### SENF

Enable or disable root PCIe system error on non-fatal error.

#### SECE

Enable or disable PCIe system error on correctable error.

#### PME SCI

Enable or disable PCIe PME SCI.

#### Hot plug

Enable or disable PCIe hot plug.

#### PCIe speed

Select the PCIe speed.

### USB Configuration

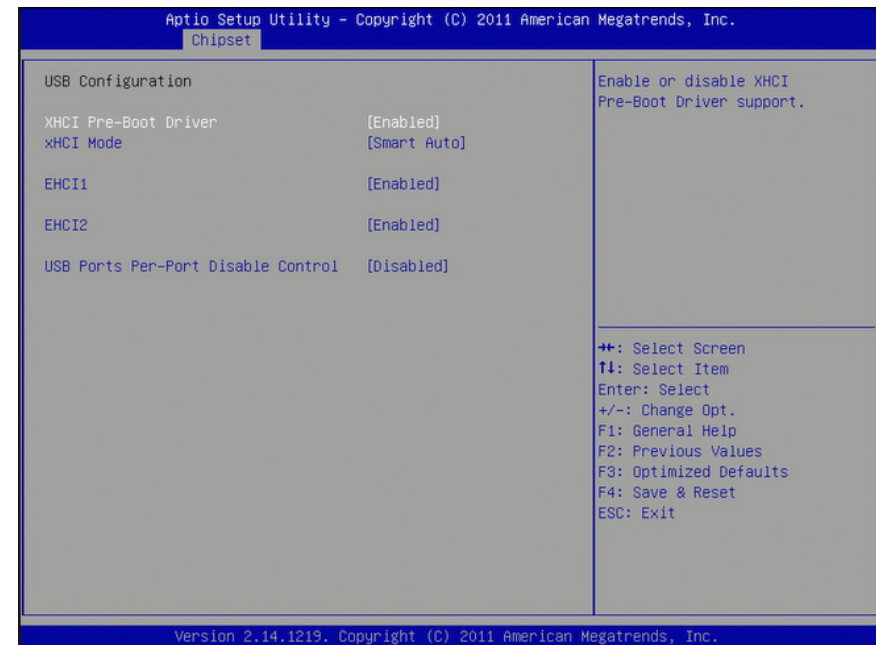

#### xHCI Mode

Mode of operation of xHCI controller. Options are Smart Auto, Auto, Enabled, Disabled.

#### EHCI1 and EHCI2

These fields are used to enable or disable USB 2.0.

#### USB Ports Per-Port Disable Control

Control each of the USB ports (0~13) disabling.

## PCH Azalia Configuration



### Azalia internal HDMI codec

Enable or disable the Azalia internal HDMI codec.

## North Bridge

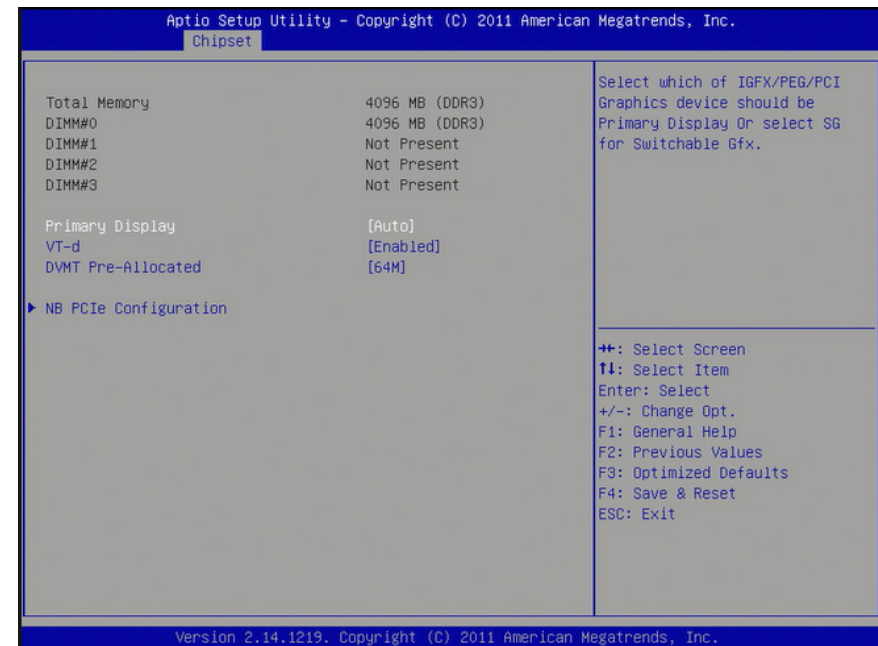

### Primary Display

**Auto** When the system boots, it will auto detects the display device.

**IGFX** When the system boots, it will first initialize the onboard VGA.

**PEG** When the system boots, it will first initialize the PCI Express x16 graphics card.

**PCI** When the system boots, it will first initialize the PCI graphic card.

### VT-d

Check to enable VT-d function on MCH.

### DVMT Pre-Allocated

Select DVMT 5.0 Pre-Allocated (Fixed) Graphics Memory size used by the Internal Graphics Device.

**NB PCIe Configuration**

This field is used to configure the PCI Express settings of the North Bridge.

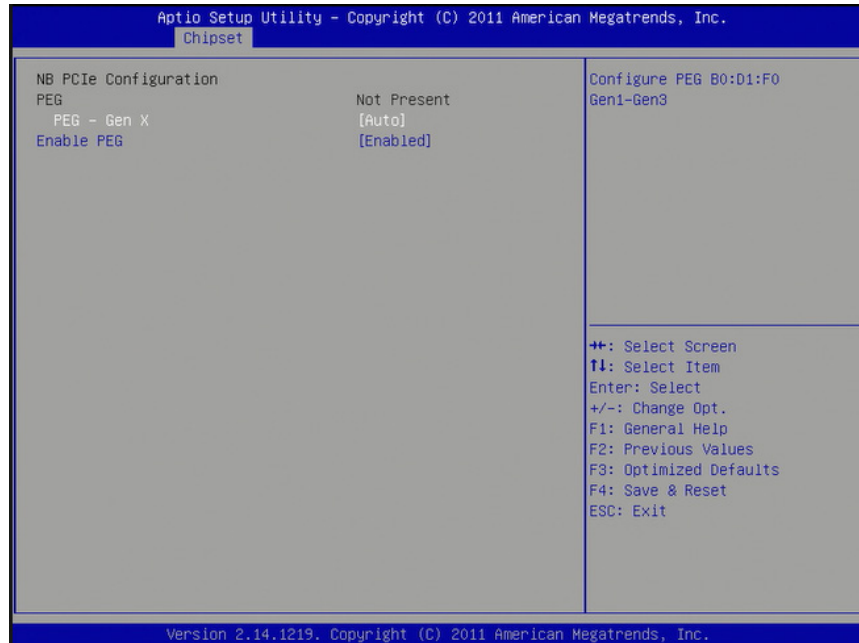
**PEG - Gen X**

Selects the speed of the PEG.

**Enable PEG**

Enable or disable the PEG.

**ME Subsystem**

This field is used to configure the Intel ME firmware.

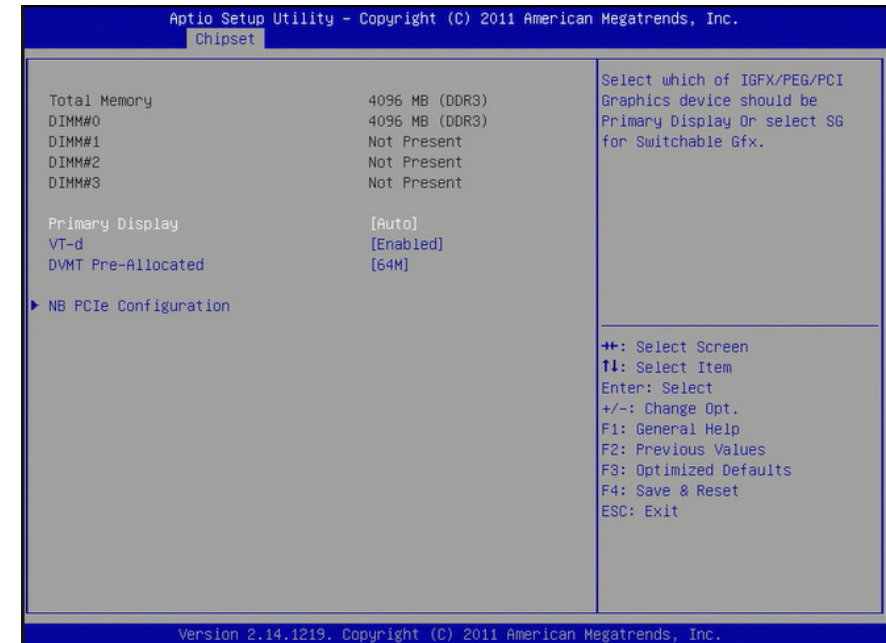
**Me firmware Image Re-Flash**

Enable/Disable the firmware image re-flashing.

## Boot

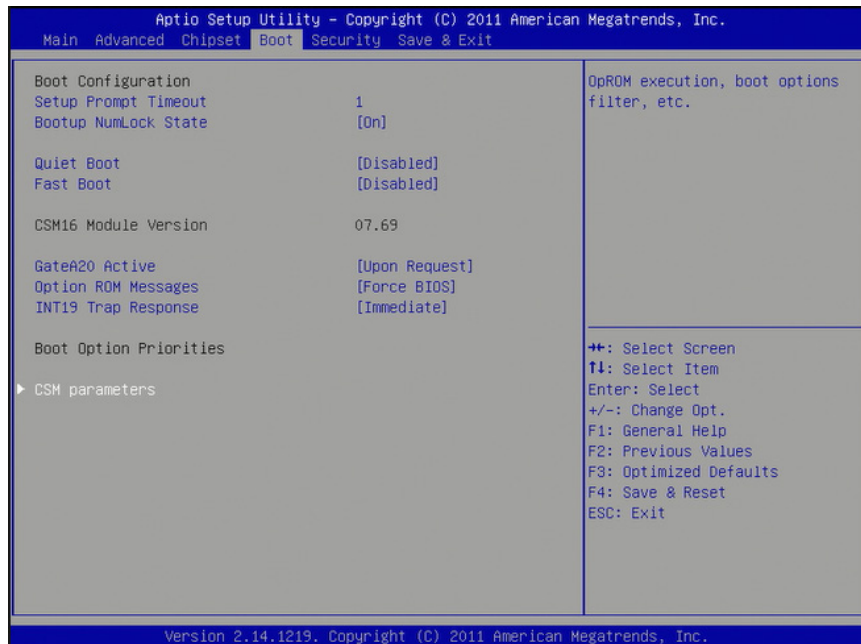

### Setup Prompt Timeout

Selects the number of seconds to wait for the setup activation key. 65535(0xFFFF) denotes indefinite waiting.

### Bootup NumLock State

This allows you to determine the default state of the numeric keypad. By default, the system boots up with NumLock on wherein the function of the numeric keypad is the number keys. When set to Off, the function of the numeric keypad is the arrow keys.

### Quiet Boot

Enables or disables the quiet boot function.

### Fast Boot

Enables or disables boot with initialization of a minimal set of devices required to launch active boot option. Has no effect for BBS boot options.

### GateA20 Active

Upon Request- GA20 can be disabled using BIOS services.

Always- Do not allow disabling GA20; this option is useful when any RT code is executed above 1MB.

### Option ROM Messages

Set display mode for option ROM.

### Int19 Trap Response

BIOS reaction on Int19 trapping by option ROM.

Immediate- execute the trap right away.

Postpone- execute the trap during legacy boot.

## CSM Parameters

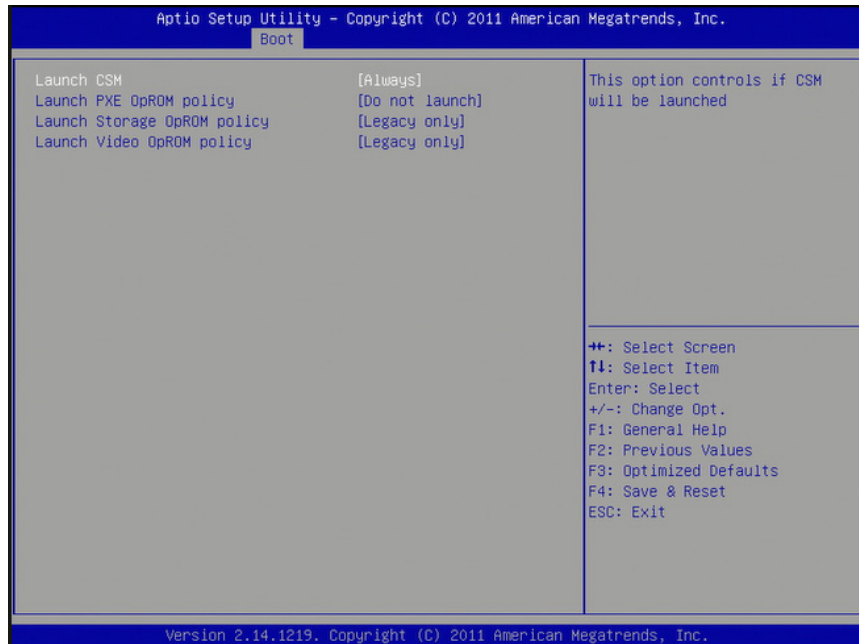

### Launch PXE OpROM policy

Controls the execution of UEFI and legacy PXE OpROM.

### Launch Storage OpROM policy

Controls the execution of UEFI and legacy storage OpROM.

### Launch Video OpROM policy

Controls the execution of UEFI and legacy video OpROM.

## Security

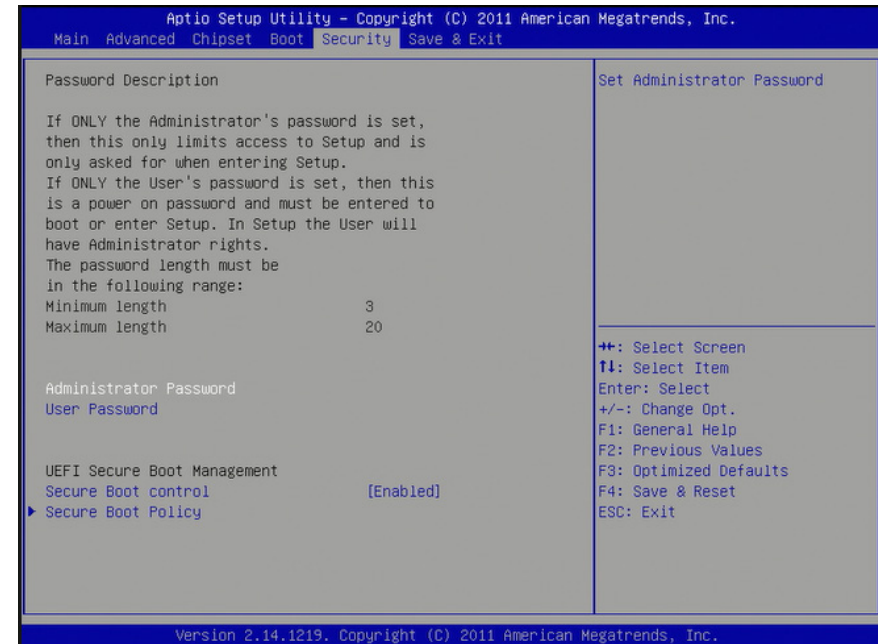

### Administrator Password

Sets the administrator password.

### User Password

Sets the user password.

### Secure Boot Control

Secure boot flow control. Secure boot is possible only if system runs in User Mode.

## Security Boot Policy

This screen sets the Image Execution Policy on Security Violation. It configures permission/denial of different kind of Images when secure boot is enabled.

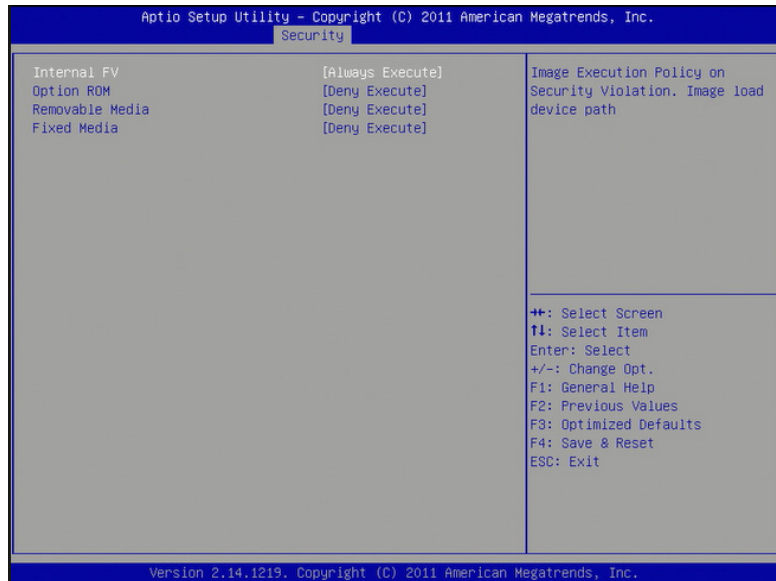

### Internal FV

The option is Always Execute.

### Option ROM

The options are Always Execute, Always Deny, Allow Execute, Defer Execute, Deny Execute, and Query User.

### Removable Media

The options are Always Execute, Always Deny, Allow Execute, Defer Execute, Deny Execute, and Query User.

### Fixed Media

The options are Always Execute, Always Deny, Allow Execute, Defer Execute, Deny Execute, and Query User.

## Save & Exit

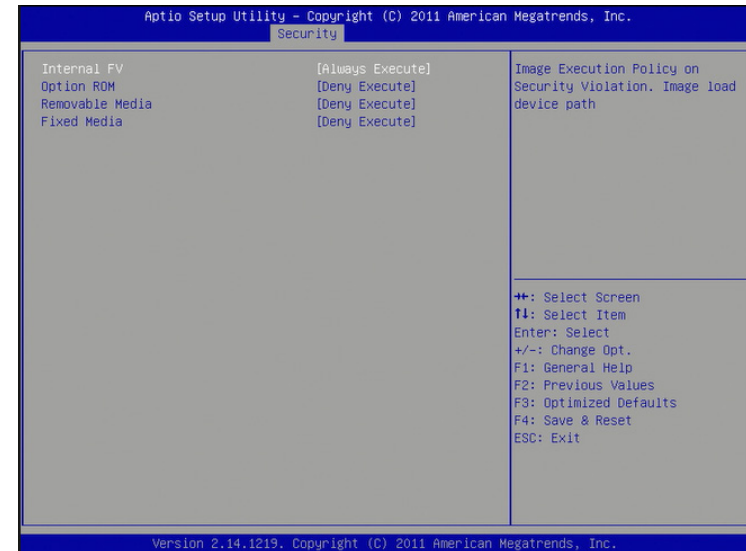

### Save Changes and Reset

To save the changes, select this field and then press <Enter>. A dialog box will appear. Select Yes to reset the system after saving all changes made.

### Discard Changes and Reset

To discard the changes, select this field and then press <Enter>. A dialog box will appear. Select Yes to reset the system setup without saving any changes.

### Save Changes

Save changes done so far to any of the setup options.

### Discard Changes

Discard changes done so far to any of the setup options.

### Restore Defaults

To restore and load the optimized default values, select this field and then press <Enter>. A dialog box will appear. Select Yes to restore the default values of all the setup options.

### Save as User Defaults

To save changes done so far as user default, select this field and then press <Enter>. A dialog box will appear. Select Yes to save values as user default.

### Restore User Defaults

To restore user default to all the setup options, select this field and then press <Enter>. A dialog box will appear. Select Yes to restore user default.

## Updating the BIOS

To update the BIOS, you will need the new BIOS file and a flash utility, AFUDOS.EXE. Please contact technical support or your sales representative for the files.

To execute the utility, type:

A:> AFUDOS BIOS\_File\_Name /b /p /n  
then press <Enter>.

```
C:\AFU\AFUDOS>afudos filename /B /P /N
+-----+
|              AMI Firmware Update Utility(APTIO) v2.25              |
|              Copyright (C)2008 American Megatrends Inc. All Rights Reserved.              |
+-----+
Reading file ..... done
Erasing flash ..... done
Writing flash ..... done
Verifying flash ..... done
Erasing BootBlock ..... done
Writing BootBlock ..... done
Verifying BootBlock ..... done
C:\AFU\AFUDOS>
```

## Notice: BIOS SPI ROM

1. The Intel® Management Engine has already been integrated into this system board. Due to the safety concerns, the BIOS (SPI ROM) chip cannot be removed from this system board and used on another system board of the same model.
2. The BIOS (SPI ROM) on this system board must be the original equipment from the factory and cannot be used to replace one which has been utilized on other system boards.
3. If you do not follow the methods above, the Intel® Management Engine will not be updated and will cease to be effective.

### Note:

- a. You can take advantage of flash tools to update the default configuration of the BIOS (SPI ROM) to the latest version anytime.
- b. When the BIOS IC needs to be replaced, you have to populate it properly onto the system board after the EEPROM programmer has been burned and follow the technical person's instructions to confirm that the MAC address should be burned or not.





## Chapter 8 - Supported Software

Some devices of the system require drivers from hardware manufactures to operate properly. The system may come with a CD/DVD that contains drivers, utilities and software applications. Insert the CD into a CD-ROM drive. The auto-run screen (Mainboard Utility CD) will appear. If the "Autorun" does not automatically start, please go to the root directory of the CD and double-click "Setup".

If your product package does not include a CD/DVD, you can download the latest drivers from the DFI Download Center:

<http://www.dfi.com/DownloadCenter>

Once you are in the Download Center page, select your product or type the model name and click "Search" to find product-related resources such as documentation and drivers.

### Auto Run Pages

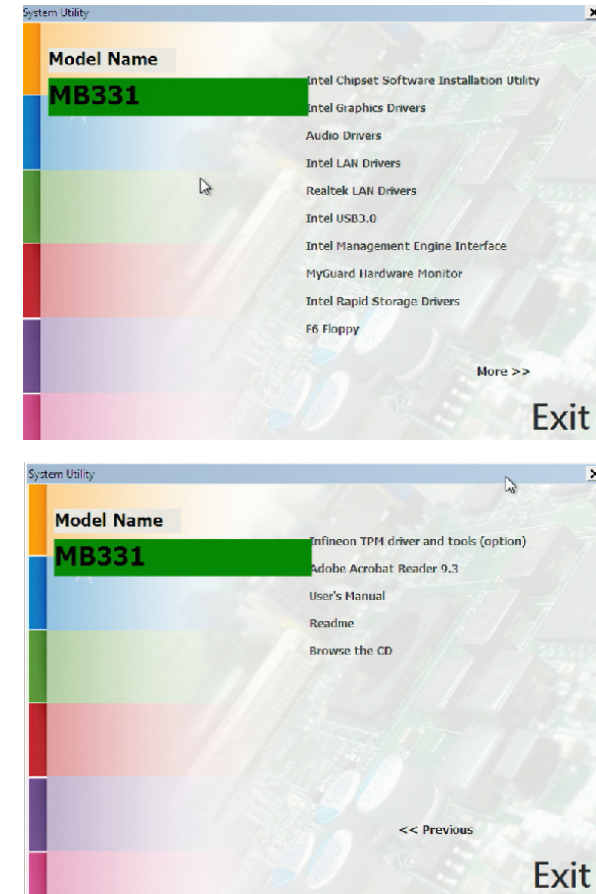

**Note:**

Depending on your model, the model name displayed on the DVD can be either MB330 or MB331.



## Intel Chipset Software Installation Utility

The Intel Chipset Software Installation Utility is used for updating Windows® INF files so that the Intel chipset can be recognized and configured properly in the system.

To install the utility, click "Intel Chipset Software Installation Utility" on the main menu.

1. Setup is ready to install the utility. Click Next.



2. Read the license agreement then click Yes.



3. Go through the readme document for more installation tips then click Next.



4. Click Finish to exit setup.



## Intel Graphics Drivers

To install the driver, click "Intel Graphics Drivers" on the main menu.

1. Setup is now ready to install the graphics driver. Click Next.



By default, the "Automatically run WinSAT and enable the Windows Aero desktop theme" is enabled. With this enabled, after installing the graphics driver and the system rebooted, the screen will turn blank for 1 to 2 minutes (while WinSAT is running) before the Windows 7/Windows 8.1/Windows 10 desktop appears. The "blank screen" period is the time Windows is testing the graphics performance.

2. Read the license agreement then click Yes.

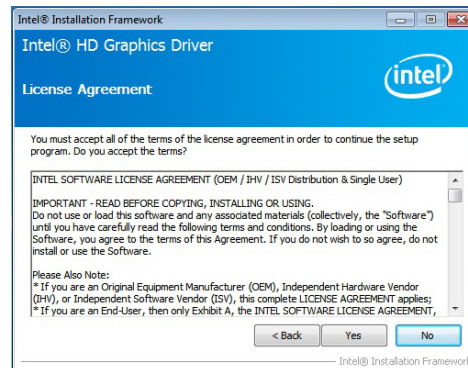

3. Go through the readme document for system requirements and installation tips then click Next.

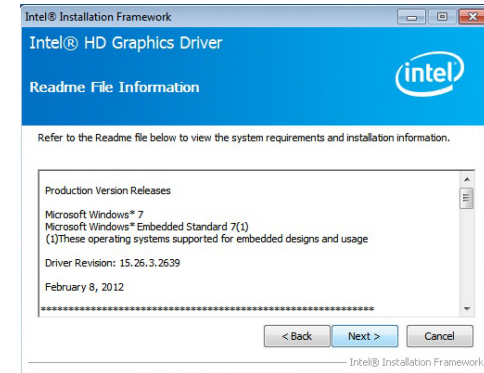

4. Setup is now installing the driver. Click Next to continue.

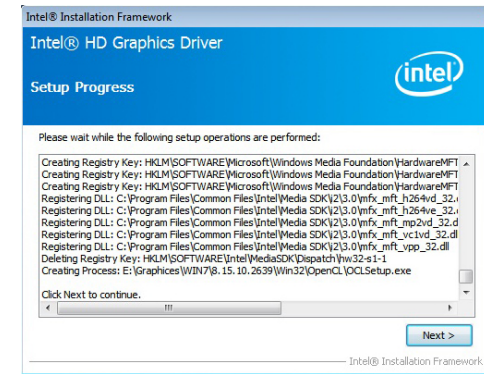

5. Click "Yes, I want to restart this computer now" then click Finish.

Restarting the system will allow the new software installation to take effect.

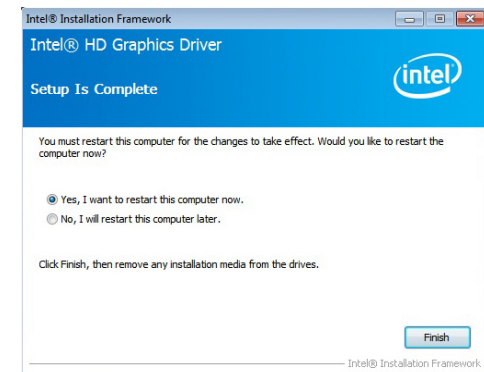

## Audio Drivers

To install the driver, click "Audio Drivers" on the main menu.

1. Setup is ready to install the driver. Click Next.

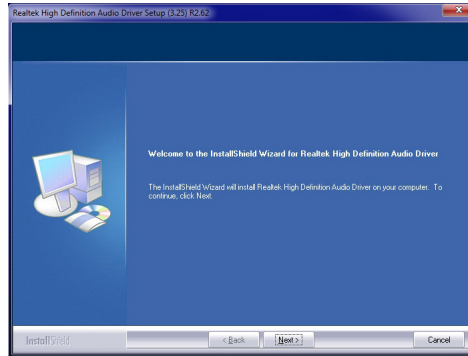

2. Click "Yes, I want to restart my computer now" then click Finish.

Restarting the system will allow the new software installation to take effect.

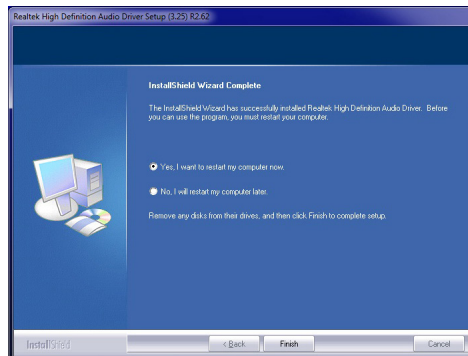

## Intel LAN Drivers

To install the driver, click "Intel LAN Drivers" on the main menu.

1. Setup is ready to install the driver. Click Next.



2. Click "I accept the terms in the license agreement" then click "Next".



3. Select the program features you want installed then click Next.

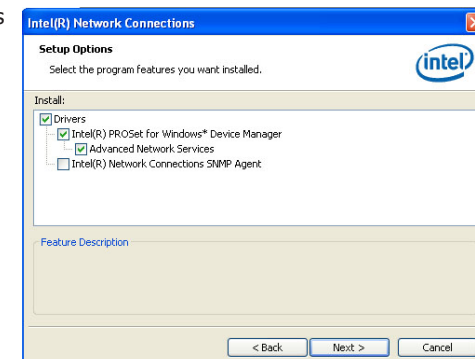

4. Click Install to begin the installation.

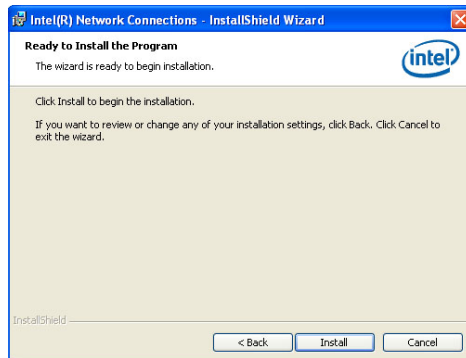

5. After completing installation, click Finish.

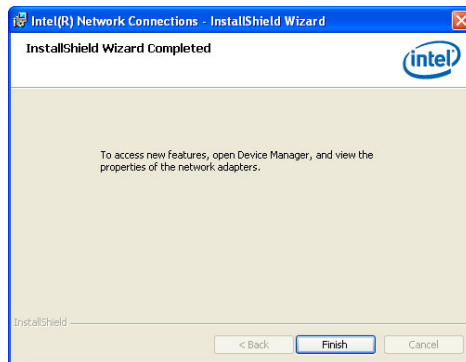

## Intel Management Engine Drivers

To install the driver, click "Intel Management Engine Drivers" on the main menu.

1. Setup is ready to install the driver. Click "Next".

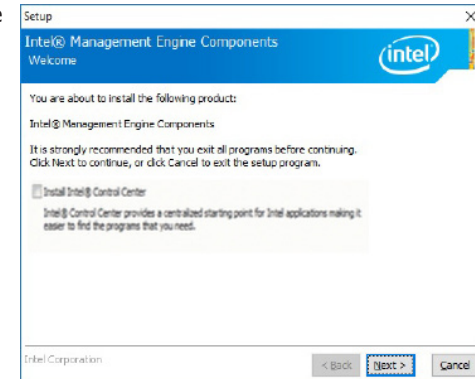

2. Read the license agreement then click "Next".

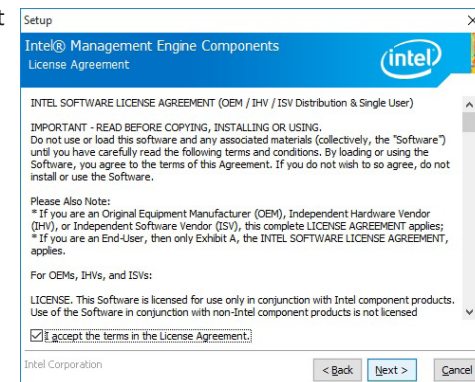

3. Setup is currently installing the driver. After installation has completed, click "Next".

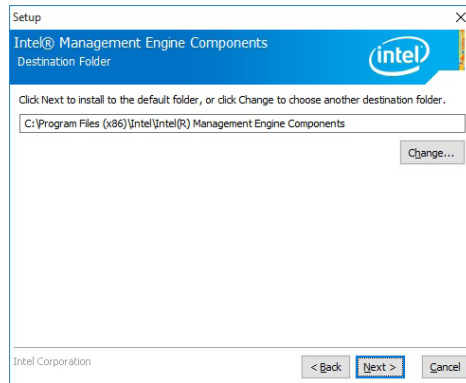

4. Please wait while the product is being installed.

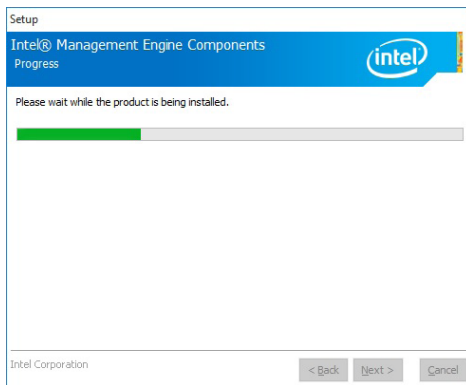

5. After completing installation, click "Finish".

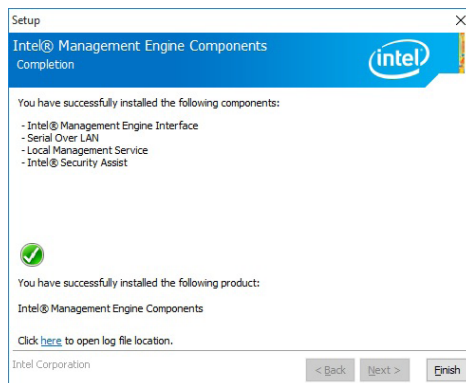

## Infinion TPM 1.2 Driver and Tool (Optional)

To install the driver, click "Infinion TPM driver and tool (option)" on the main menu.

1. The setup program is preparing to install the driver.

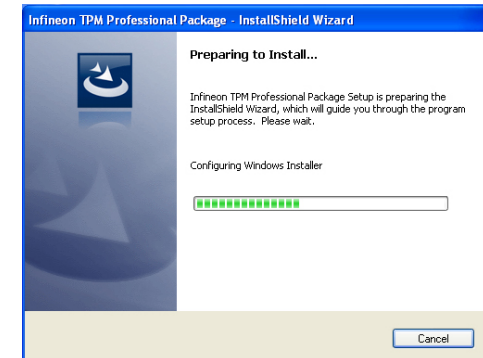

2. The setup program is now ready to install the utility. Click "Next".

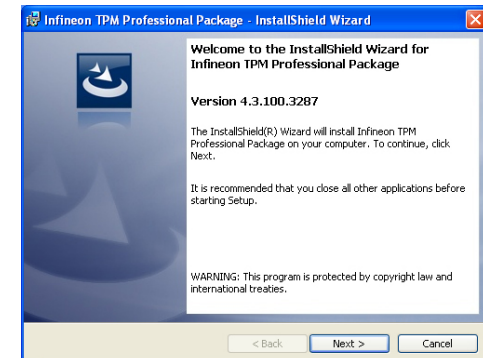

3. Click "I accept the terms in the license agreement" and then click "Next".

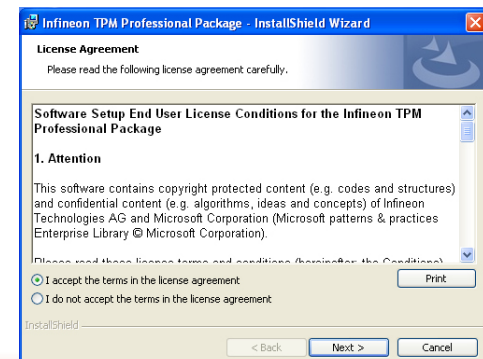

4. Enter the necessary information and then click "Next".

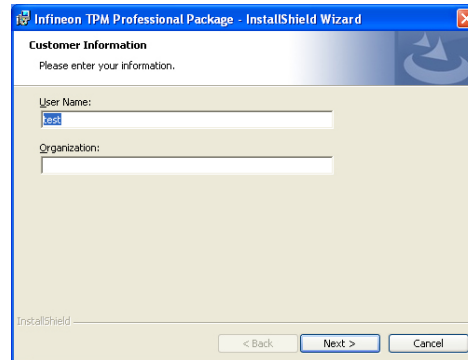

5. Select a setup type and then click "Next".

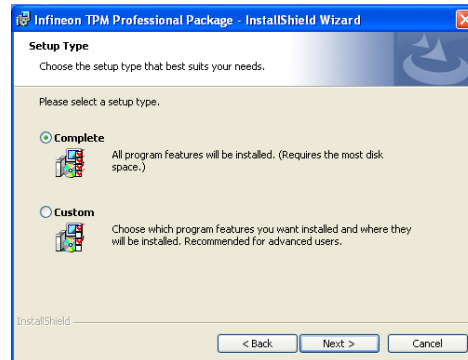

6. Click "Install".

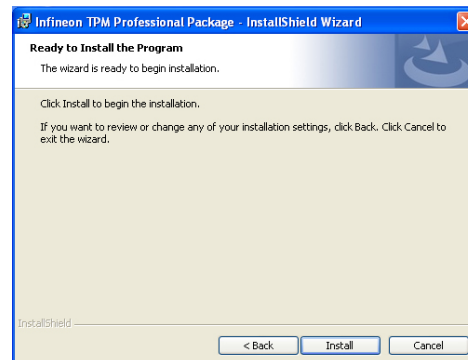

## Intel USB 3.0 Drivers

To install the driver, click "Intel USB 3.0 Driver" on the main menu.

1. Setup is ready to install the driver. Click Next.

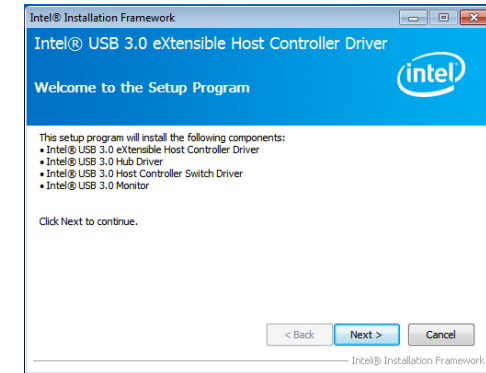

2. Read the license agreement then click Yes.

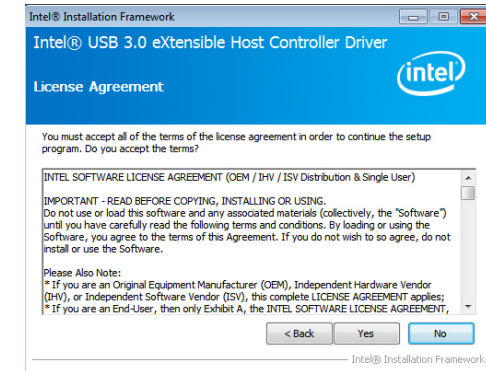



3. Go through the readme document for more installation tips then click Next.

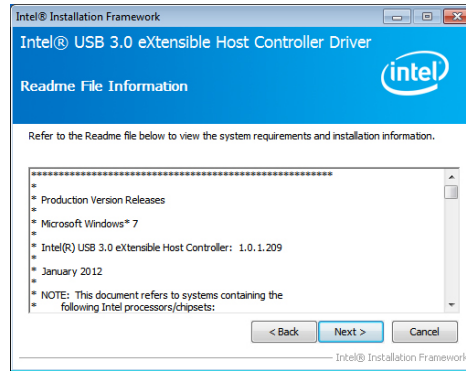

4. Setup is currently installing the driver. After installation has completed, click Next.

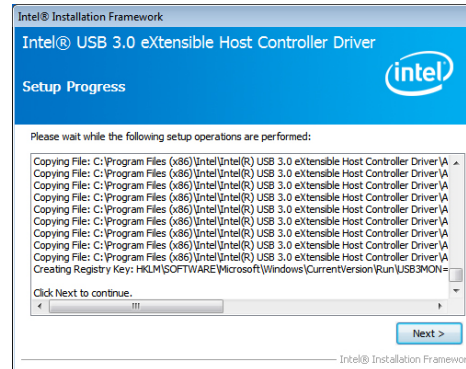

5. After completing installation, click Finish.

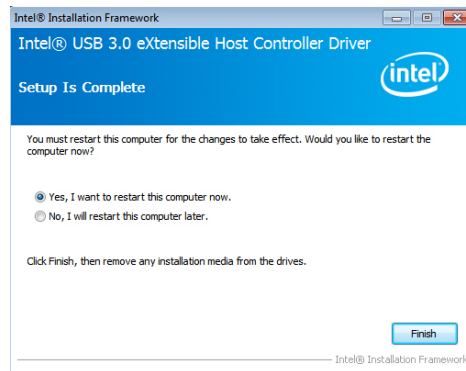

## Intel Rapid Storage Drivers

The Intel Rapid Storage Technology is a utility that allows you to monitor the current status of the SATA drives. It enables enhanced performance and power management for the storage subsystem.

To install the driver, click "Intel Rapid Storage Technology" on the main menu.

1. Setup is now ready to install the utility. Click Next.

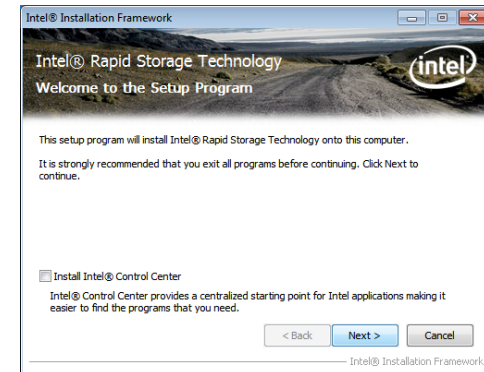

2. Read the warning then click Yes.

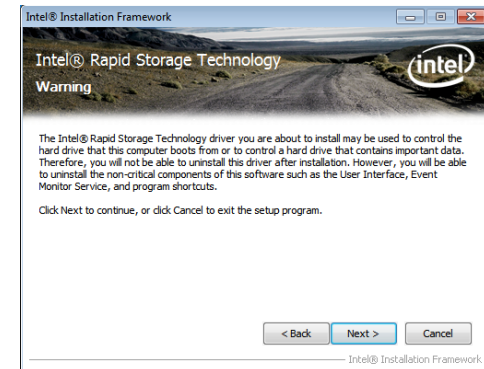

3. Read the license agreement then click Yes.

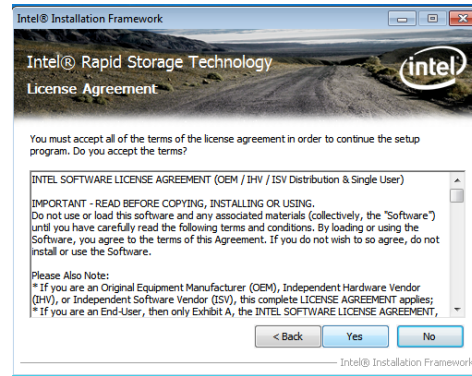

6. Click "Yes, I want to restart my computer now" then click Finish.

Restarting the system will allow the new software installation to take effect.

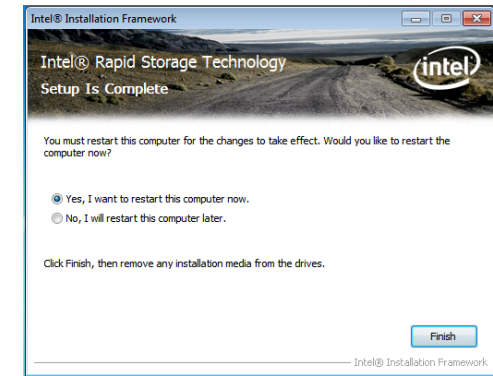

4. Go through the readme document for system requirements and installation tips then click Next.

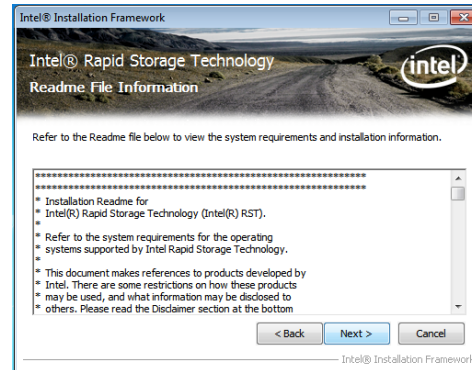

5. Setup is now installing the utility. Click Next to continue.

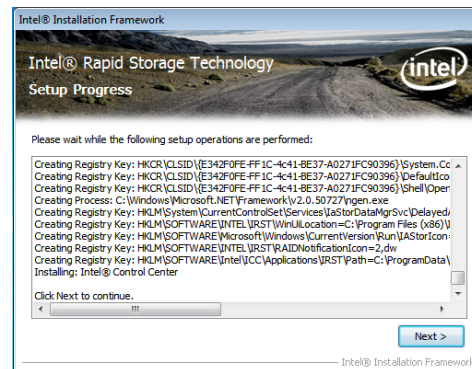



## MyGuard Hardware Monitor

1. Locate for the MyGuard folder in the provided disc.
2. In the MyGuard folder, right-click on the "setup" file.
3. Select Run As Administrator.
4. Double-click Setup.

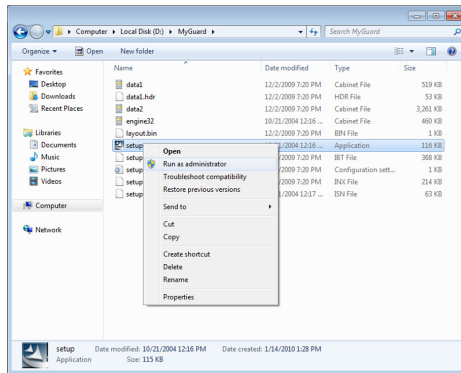

**Important:**  
Perform steps 1-3 only when using Windows 7 or later versions.

5. Setup is ready to install the utility. Click Next.

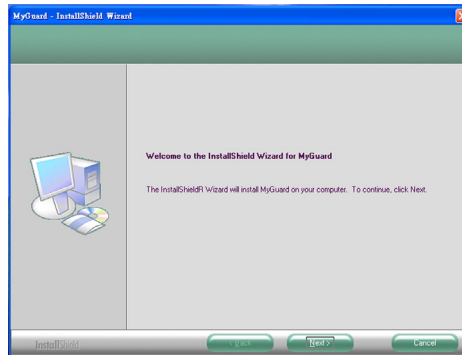

6. Click Install to begin installation.

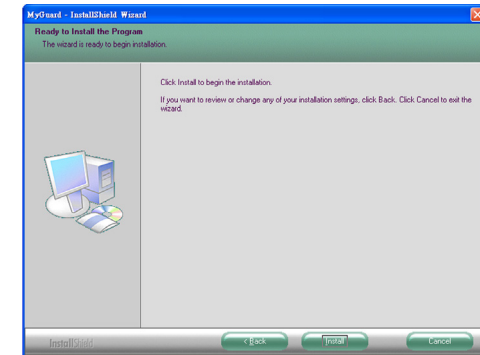

7. Setup is currently installing the utility.

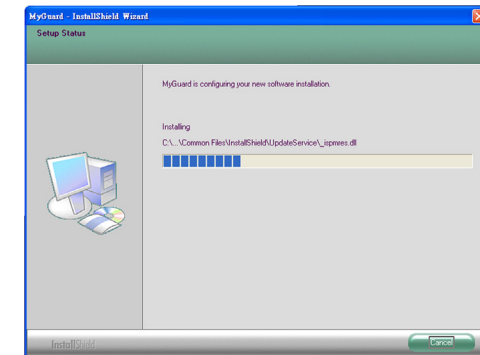

8. After completing installation, click Finish to exit setup.

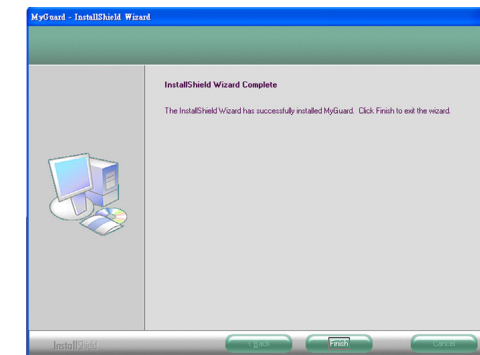

## Adobe Acrobat Reader 9.3

To install the reader, click "Adobe Acrobat Reader 9.3" on the main menu.

1. Click Next to install or click Change Destination Folder to select another folder.

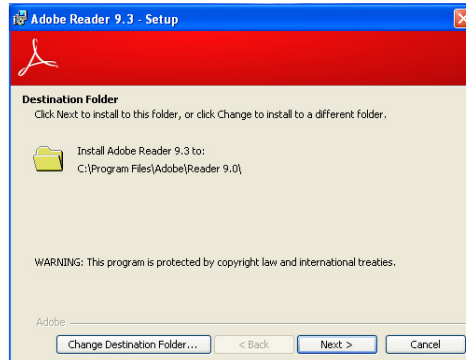

2. Click Install to begin installation.

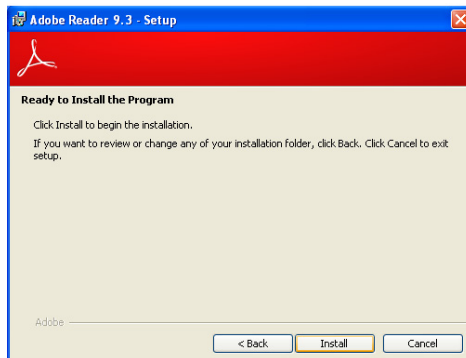

3. Click Finish to exit installation.

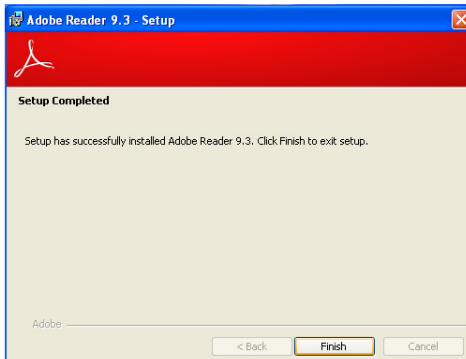

## Chapter 9 - Intel AMT Settings

### Overview

Intel Active Management Technology (Intel® AMT) combines hardware and software solution to provide maximum system defense and protection to networked systems.

The hardware and software information are stored in non-volatile memory. With its built-in manageability and latest security applications, Intel® AMT provides the following functions.

- Discover

Allows remote access and management of networked systems even while PCs are powered off; significantly reducing desk-side visits.

- Repair

Remotely repair systems after OS failures. Alerting and event logging help detect problems quickly to reduce downtime.

- Protect

Intel AMT's System Defense capability remotely updates all systems with the latest security software. It protects the network from threats at the source by proactively blocking incoming threats, reactively containing infected clients before they impact the network, and proactively alerting when critical software agents are removed.

### Enable Intel® AMT in the AMI BIOS

- Power-on the system then press <Del> to enter the main menu of the AMI BIOS.
- In the **Advanced** menu, select **AMT Configuration**.

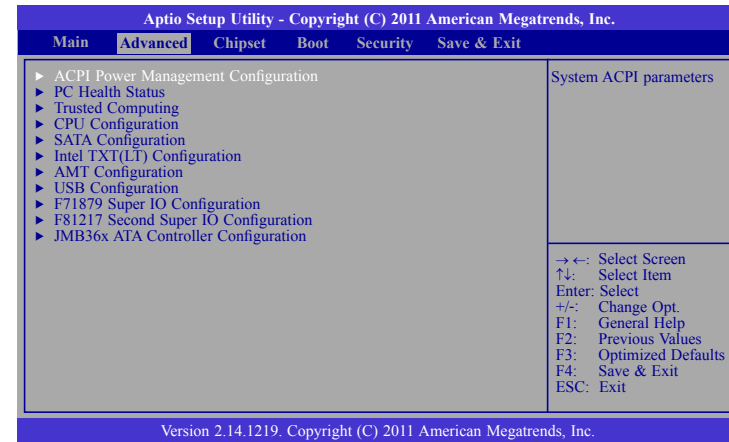

- In the **Advanced** menu, select **Enable** in the **AMT** field.

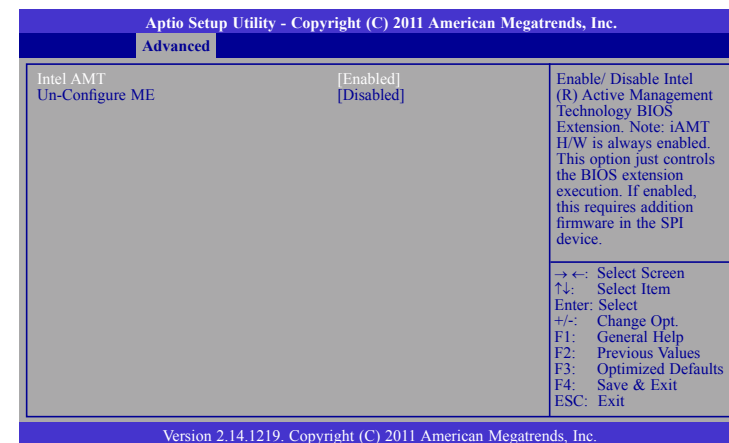

4. In the **Save & Exit** menu, select **Save Changes and Reset** then select **OK**.

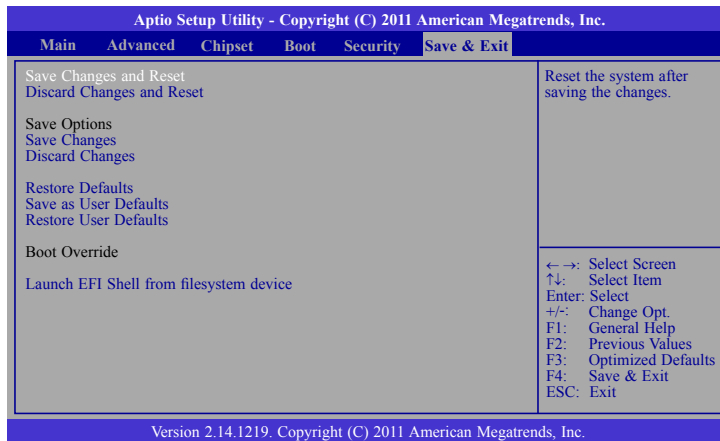

## Enable Intel® AMT in the Intel® Management Engine BIOS Extension (MEBX) Screen

1. When the system reboots, the following message will be displayed. Press **<Ctrl-P>** as soon as the message is displayed; as this message will be displayed for only a few seconds.

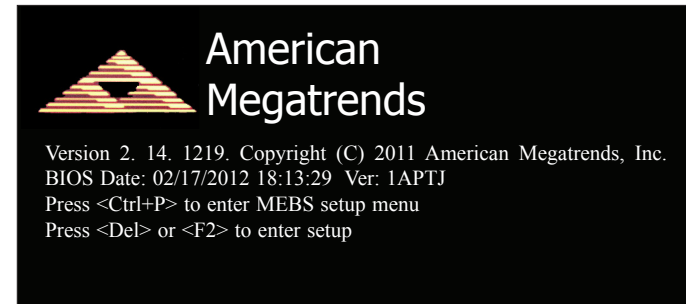

2. You will be prompted for a password. The default password is **"admin"**. Enter the default password in the space provided under Intel(R) ME Password then press Enter.

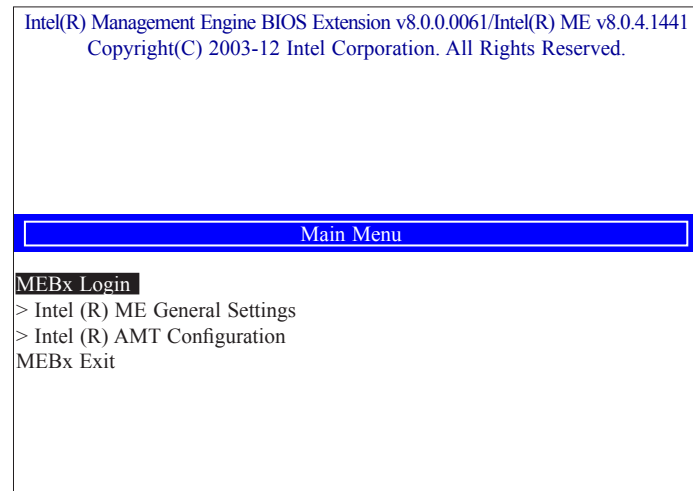

Intel (R) ME Password

[↑↓] = Move highlight [ENTER] = Select Entry [ESC]= Exit

3. Enter a new password in the space provided under Intel(R) ME New Password then press Enter. The password must include:

8-32 characters

Strong 7-bit ASCII characters excluding : , and " characters

At least one digit character (0, 1, ...9)

At least one 7-bit ASCII non alpha-numeric character, above 0x20, (e.g. !, \$, ;)

Both lower case and upper case characters

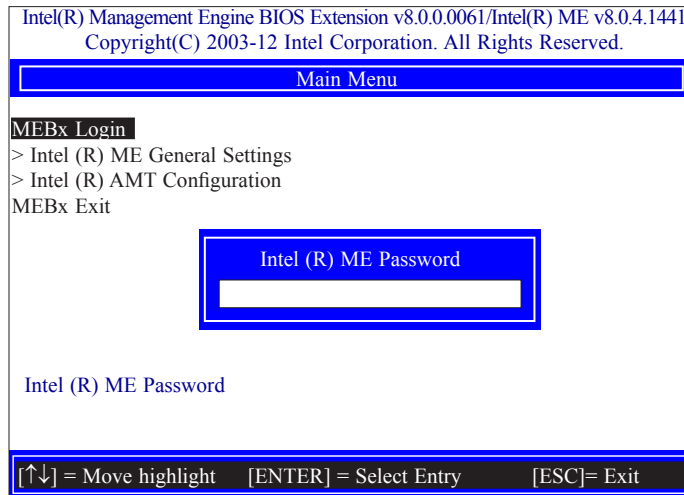

4. You will be asked to verify the password. Enter the same new password in the space provided under Verify Password then press Enter.

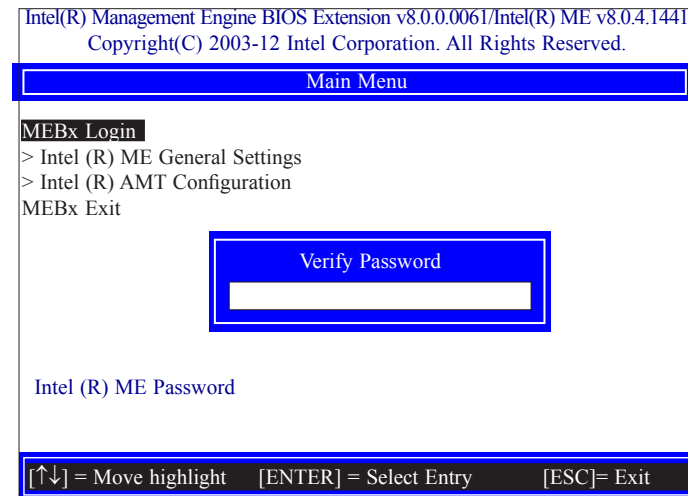

5. Select **Intel(R) ME General Settings** then press Enter.

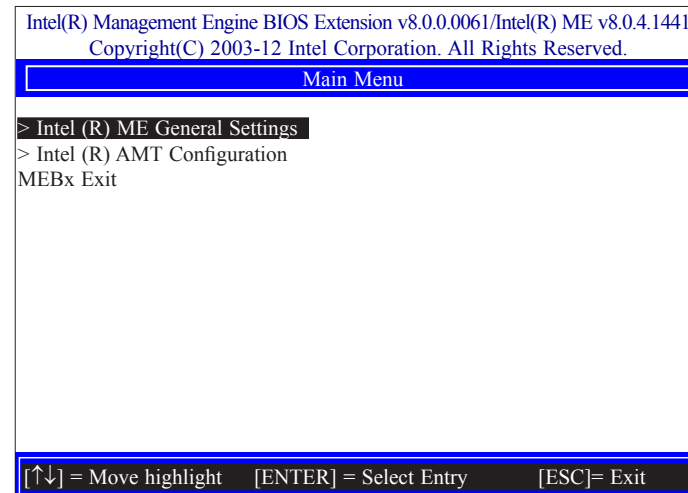

6. Select **Change Intel(R) ME Password** then press Enter. You will be prompted for a password. The default password is "admin". Enter the default password in the space provided under Intel(R) ME New Password then press Enter.

8-32 characters

Strong 7-bit ASCII characters excluding : , and " characters

At least one digit character (0, 1, ...9)

At least one 7-bit ASCII non alpha-numeric character, above 0x20, (e.g. !, \$, ;)

Both lower case and upper case characters

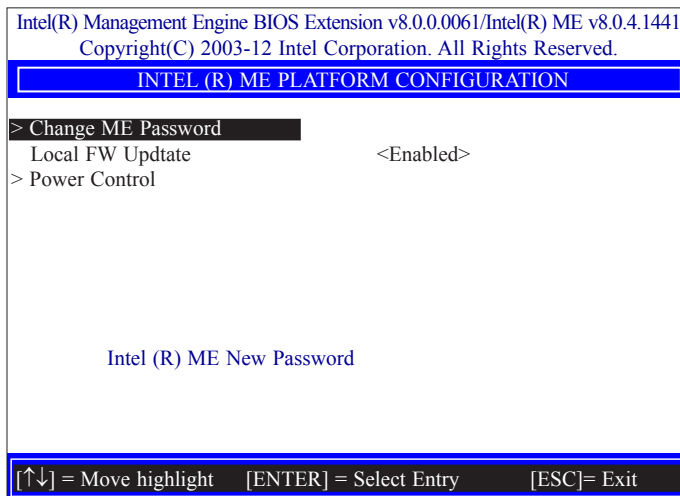

7. Select **Local FW Update** then press Enter. Select **Enabled** then press Enter.

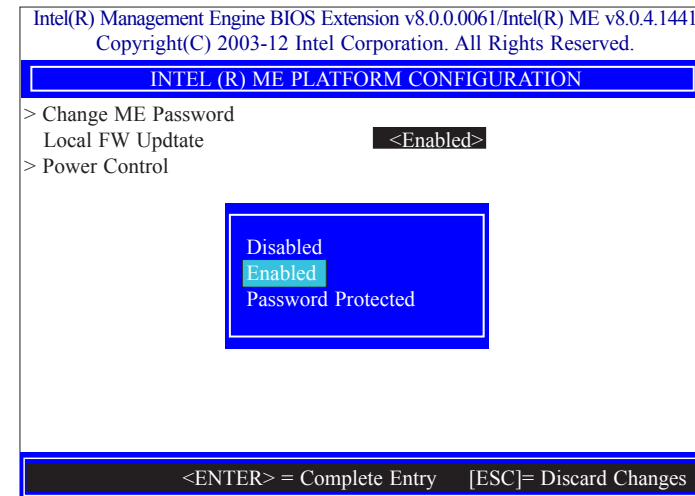

8. In the **Intel(R) ME Platform Configuration** menu, select **Power Control** then press Enter.



9. In the **Intel(R) ME Power Control** menu, select **Intel(R) ME ON in Host Sleep States** then press Enter. Select an option then press Enter.

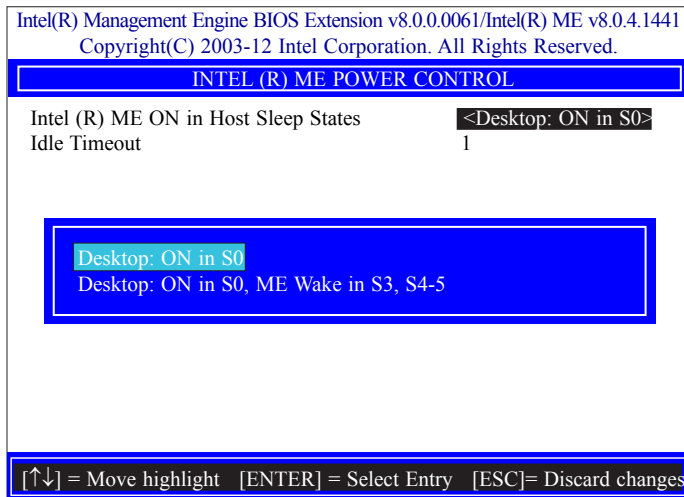

10. In the **Intel(R) ME Power Control** menu, select **Idle Timeout** then press Enter. Enter the timeout value.

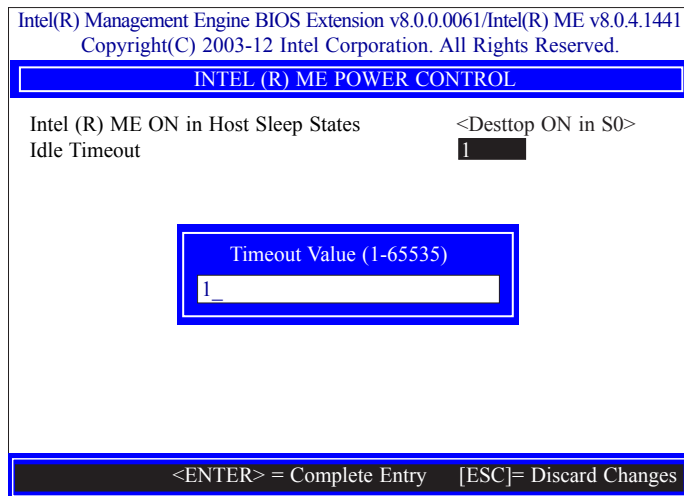

11. Select Previous Menu until you return to the **Main Menu**. Select **Intel(R) AMT Configuration** then press Enter.

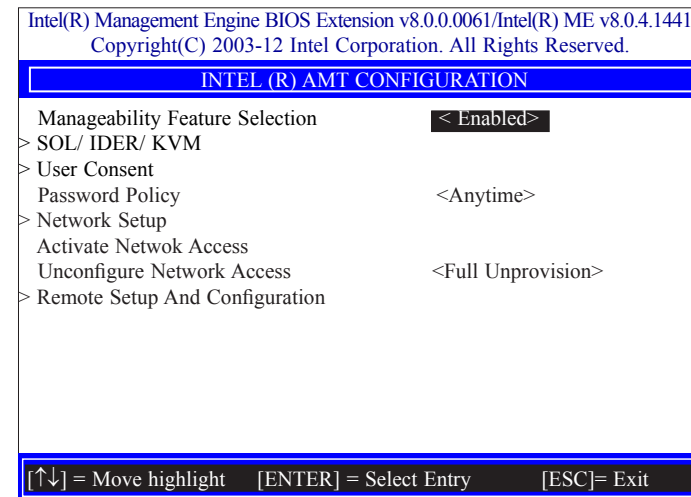

12. In the **Intel(R) AMT Configuration** menu, select **Manageability Feature Selection** then press Enter. Select disabled then press Enter.

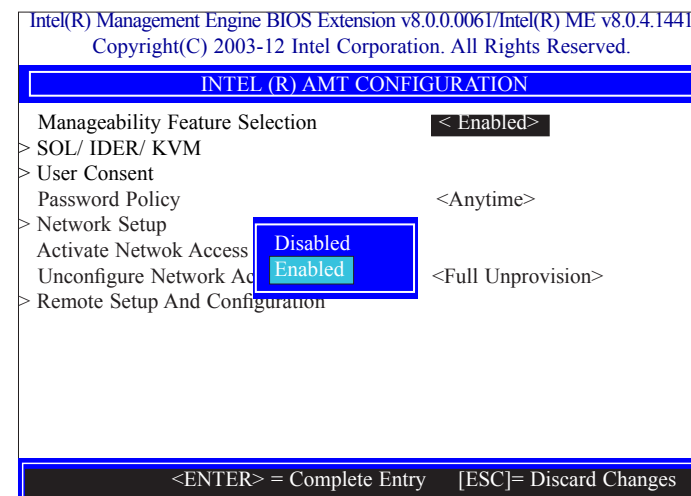

13. In the **Intel(R) AMT Configuration** menu, select **SOL/IDER/KVM** then press Enter.

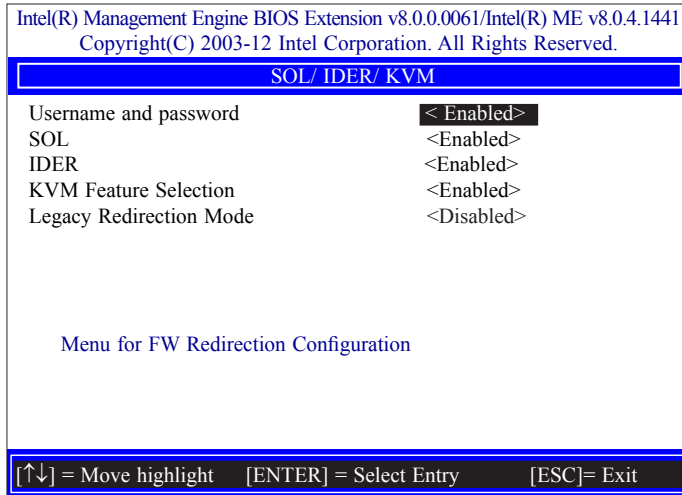

14. In the **SOL/IDER/KVM** menu, select **Username and Password** then press Enter. Select disabled then press Enter.

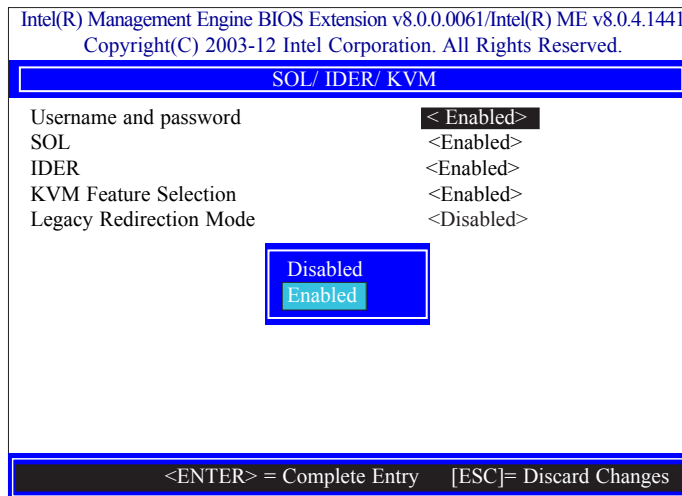

15. In the **SOL/IDER/KVM** menu, select **SOL** then press Enter. Select disabled then press Enter.

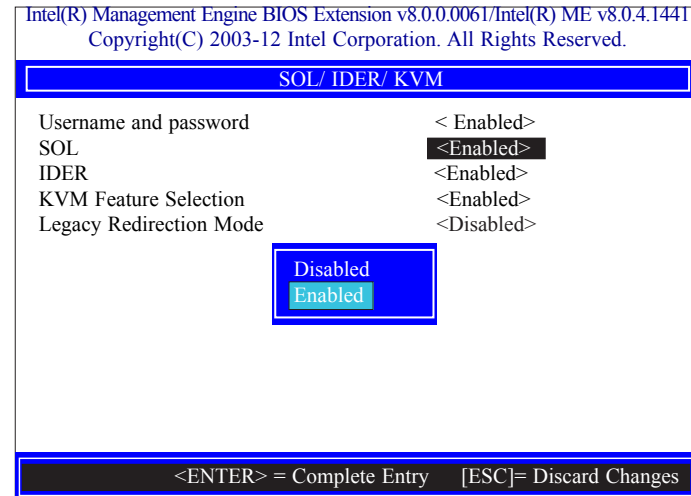

16. In the **SOL/IDER/KVM** menu, select **IDER** then press Enter. Select disabled then press Enter.

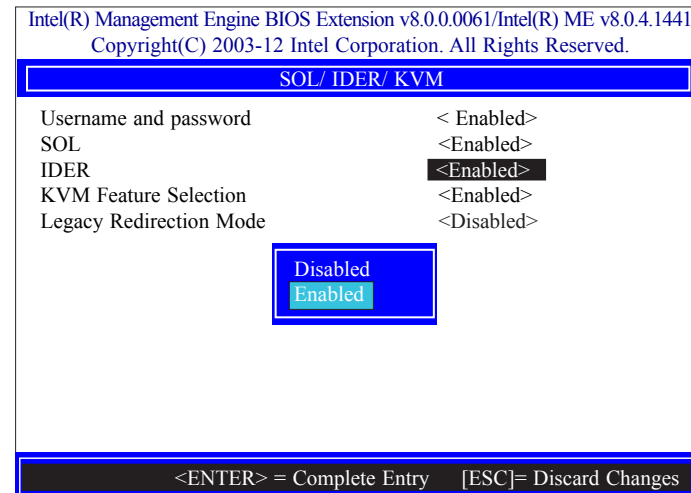



17. In the **SOL/IDER/KVM menu**, select **KVM** then press Enter. Select disabled then press Enter.

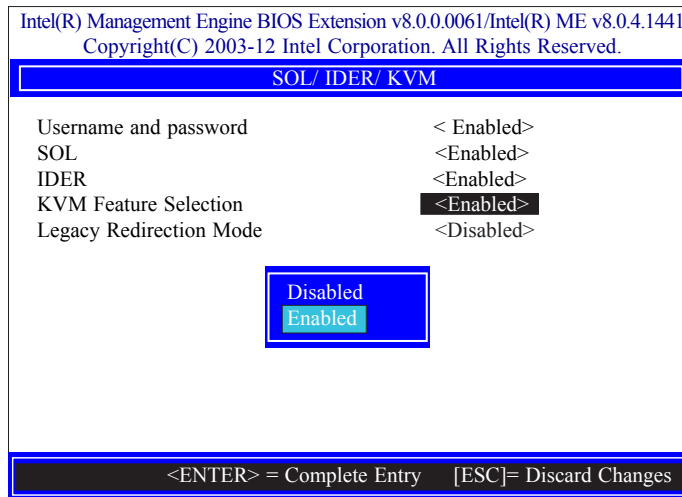

19. Select Enabled then press Enter.

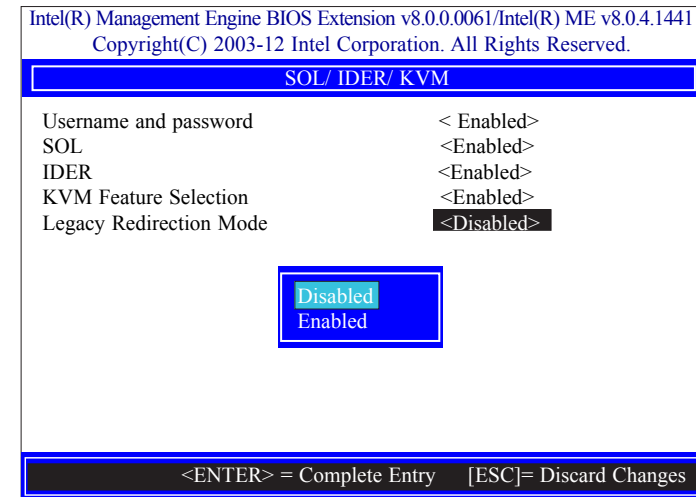

18. In the **SOL/IDER/KVM menu**, select **Legacy Redirection Mode** then press Enter.

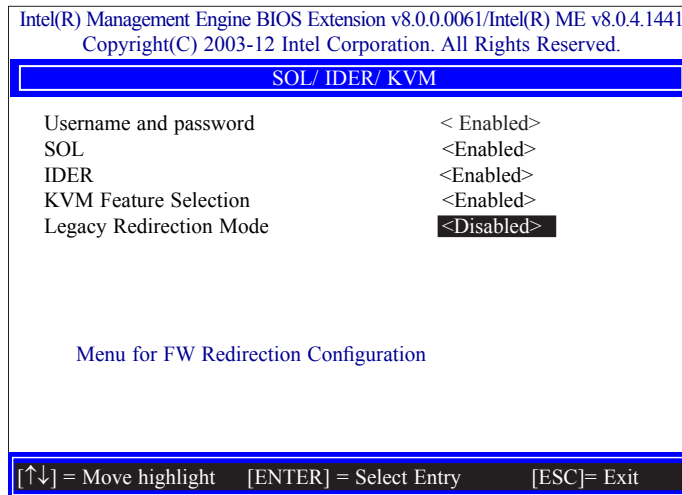

20. Select Previous Menu until you return to the **Intel(R) AMT Configuration menu**. Select **User Consent** then press Enter.

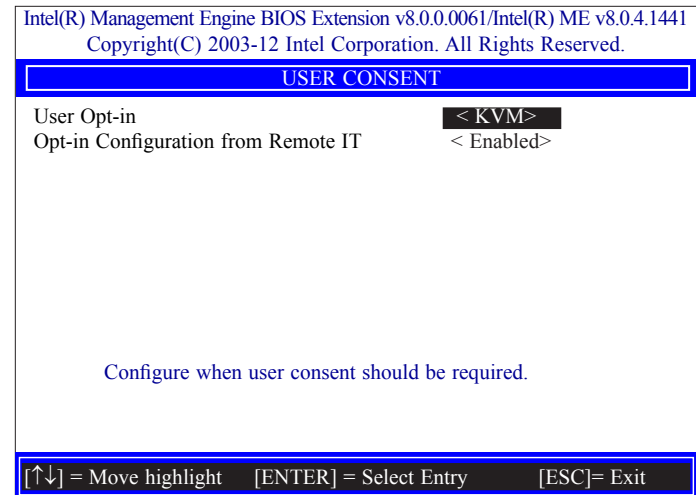

21. In the **User Consent Configuration** menu, select **User Opt-in** then press Enter. Select **None** then press Enter.

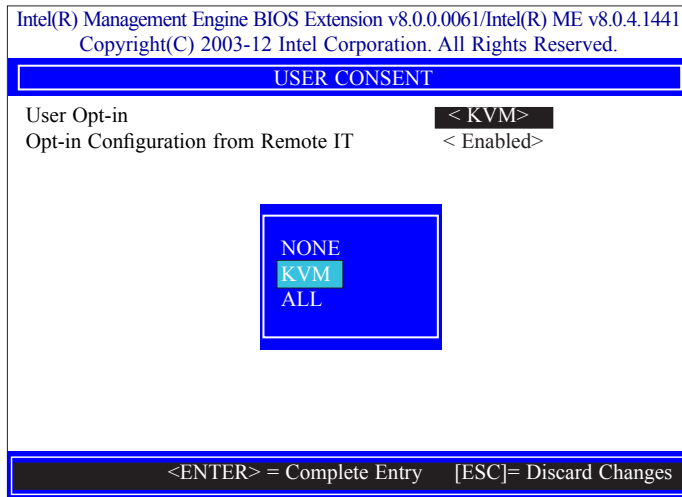

22. In the **User Consent Configuration** menu, select **Opt-in Configurable from Remote IT** then press Enter. Select **Disable Remote Control of KVM Opt-in Policy** then press Enter.

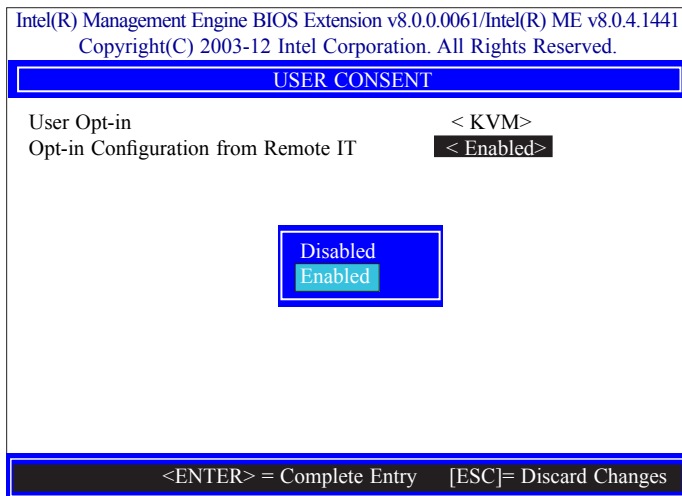

23. Select Previous Menu until you return to the **Intel(R) AMT Configuration** menu. Select **Password Policy** then press Enter.

You may choose to use a password only during setup and configuration or to use a password anytime the system is being accessed.

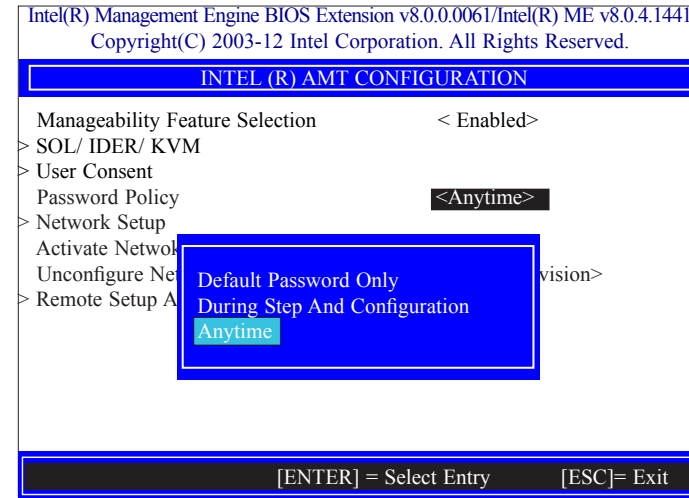

24. In the **Intel(R) AMT Configuration** menu, select **Network Setup** then press Enter.

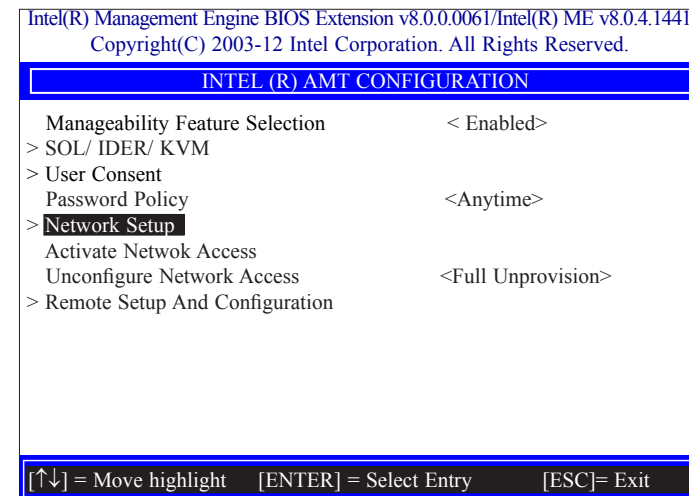

25. In the **Intel(R) Network Setup** menu, select **Intel(R) ME Network Name Settings** then press Enter.

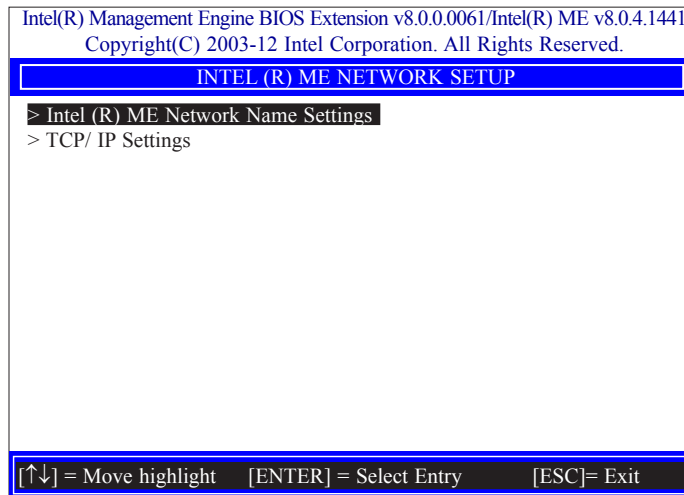

26. In the **Intel(R) ME Network Name Settings** menu, select **Host Name** then press Enter. Enter the computer's host name then press Enter.

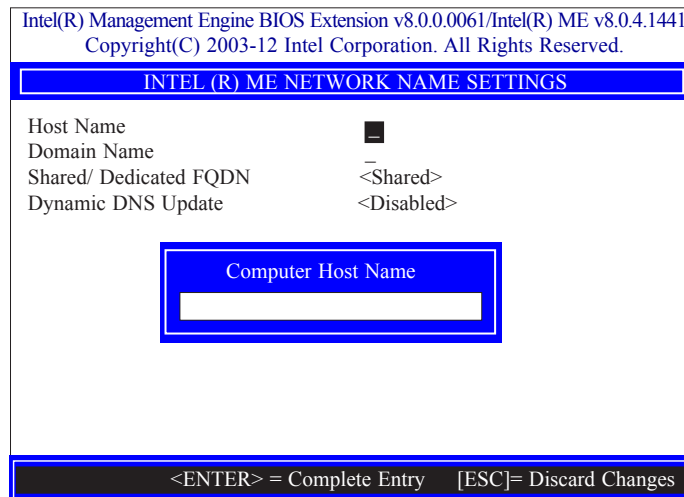

27. Select **Domain Name** then press Enter. Enter the computer's domain name then press Enter.

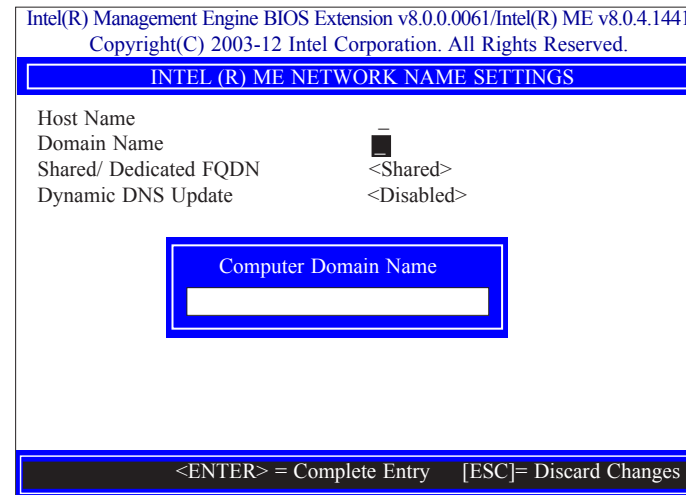

28. Select **Shared/Dedicated FQDN** then press Enter. Select Shared or Dedicated then press Enter.

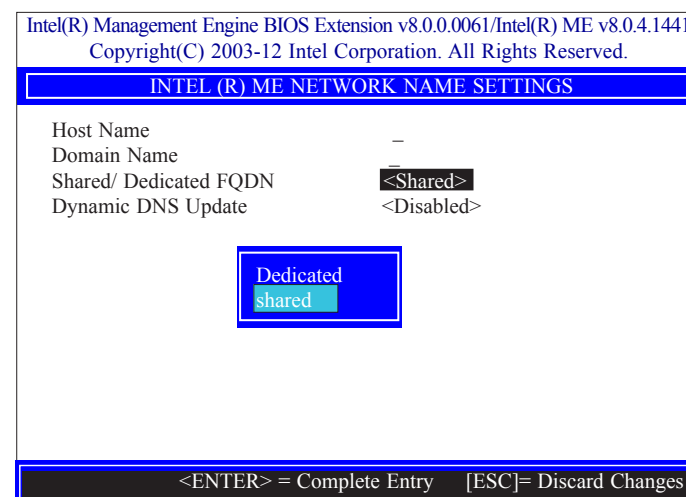

29. Select **Dynamic DNS Update** then press Enter. Select Enabled or Disabled then press Enter.

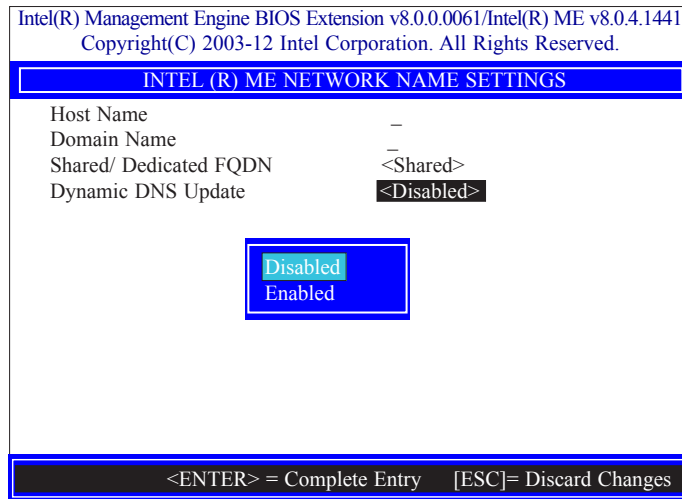

31. In the **TCP/IP Settings** menu, select **Wired LAN IPV4 Configuration** then press Enter.

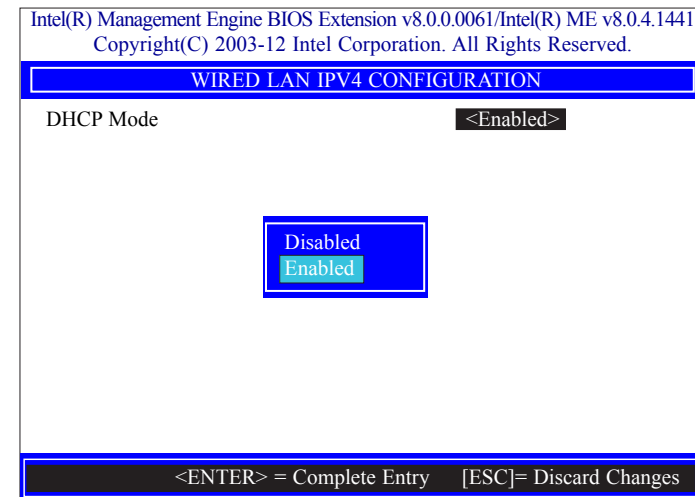

30. Select Previous Menu until you return to the **Intel(R) ME Network Setup menu**. Select **TCP/IP Settings** then press Enter.

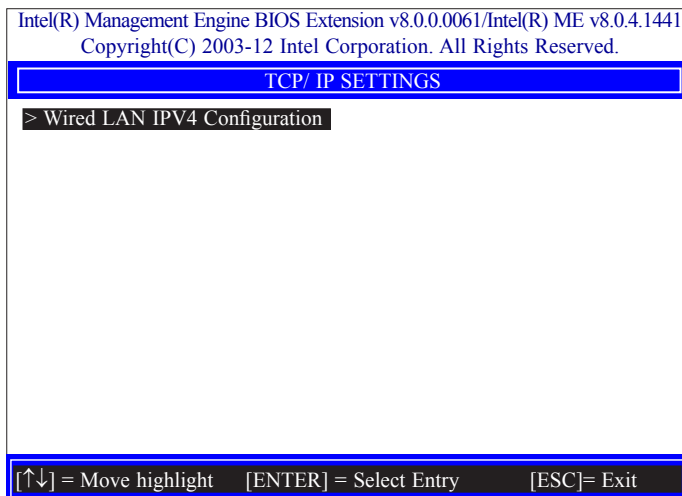

32. Select Previous Menu until you return to the **Intel(R) AMT Configuration** menu. Select **Activate Network Access** then press Enter. Type Y then press Enter.

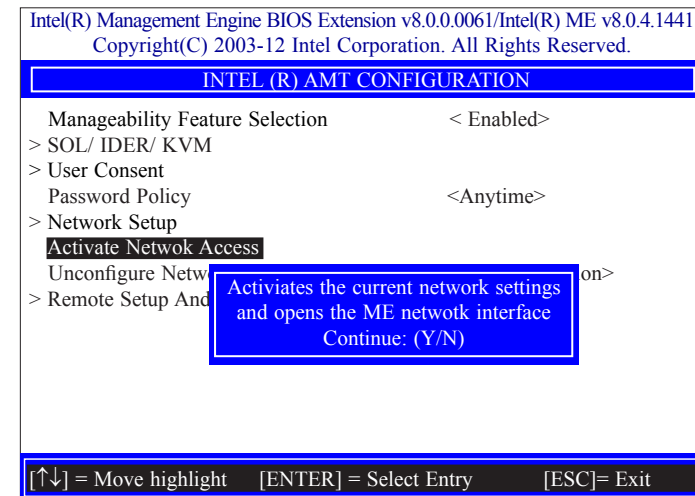

33. In the **Intel(R) AMT Configuration** menu, select **Unconfigure Network Access** then press Enter. Type Y then press Enter.

Intel(R) Management Engine BIOS Extension v8.0.0.0061/Intel(R) ME v8.0.4.1441  
Copyright(C) 2003-12 Intel Corporation. All Rights Reserved.

**INTEL (R) AMT CONFIGURATION**

Manageability Feature Selection < Enabled>  
> SOL/ IDER/ KVM  
> User Consent  
Password Policy <Anytime>  
> Network Setup  
Activate Network Access  
Unconfigure Network Access <Full Unprovision>  
> Remote Setup And Configuration

Full Unprovision  
Partial Unprovision

<ENTER> = Complete Entry [ESC]= Discard Changes

34. In the **Intel(R) AMT Configuration** menu, select **Remote Setup And Configuration** then press Enter.

Intel(R) Management Engine BIOS Extension v8.0.0.0061/Intel(R) ME v8.0.4.1441  
Copyright(C) 2003-12 Intel Corporation. All Rights Reserved.

**INTEL (R) AMT CONFIGURATION**

Manageability Feature Selection < Enabled>  
> SOL/ IDER/ KVM  
> User Consent  
Password Policy <Anytime>  
> Network Setup  
Activate Network Access  
Unconfigure Network Access <Full Unprovision>  
> Remote Setup And Configuration

[↑↓] = Move highlight [ENTER] = Select Entry [ESC]= Exit

35. In the **Intel(R) Automated Setup And Configuration** menu, select **Current Provisioning Mode** then press Enter.

Intel(R) Management Engine BIOS Extension v8.0.0.0061/Intel(R) ME v8.0.4.1441  
Copyright(C) 2003-12 Intel Corporation. All Rights Reserved.

**INTEL (R) AUTOMATED SETUP AND CONFIGURATION**

Current Provisioning Mode  
Provisioning Record  
Provisioning Server IPV4/IPV6 -  
Provisioning Server FQDN -  
> RCFG  
> TLS PSK Provisioning Mode:PKI  
> TLS PKI

[↑↓] = Move highlight [ENTER] = Select Entry [ESC]= Exit

36. In the **Intel(R) Automated Setup And Configuration** menu, select **Provisioning Record** then press Enter.

Intel(R) Management Engine BIOS Extension v8.0.0.0061/Intel(R) ME v8.0.4.1441  
Copyright(C) 2003-12 Intel Corporation. All Rights Reserved.

**INTEL (R) AUTOMATED SETUP AND CONFIGURATION**

Current Provisioning Mode  
Provisioning Record  
Provisioning Server IPV4/IPV6 -  
Provisioning Server FQDN -  
> RCFG  
> TLS PSK Provision Record is not present  
> TLS PKI

[↑↓] = Move highlight [ENTER] = Select Entry [ESC]= Exit

37. Select Previous Menu until you return to the **Intel(R) Automated Setup And Configuration menu**. Select **Provisioning Server IPV4/IPV6** then press Enter. Type server address then press Enter.

Intel(R) Management Engine BIOS Extension v8.0.0.0061/Intel(R) ME v8.0.4.1441  
Copyright(C) 2003-12 Intel Corporation. All Rights Reserved.

**INTEL (R) AUTOMATED SETUP AND CONFIGURATION**

Current Provisioning Mode  
Provisioning Record  
Provisioning Server IPV4/IPV6   
Provisioning Server FQDN   
> RCFG  
> TLS PSK  
> TLS PKI

Provisioning server address

<ENTER> = Complete Entry [ESC]= Discard Changes

38. In the **Intel(R) Automated Setup And Configuration** menu, select **Provisioning Server FQDN** then press Enter. Type FQDN of provisioning server then press Enter.

Intel(R) Management Engine BIOS Extension v8.0.0.0061/Intel(R) ME v8.0.4.1441  
Copyright(C) 2003-12 Intel Corporation. All Rights Reserved.

**INTEL (R) AUTOMATED SETUP AND CONFIGURATION**

Current Provisioning Mode  
Provisioning Record  
Provisioning Server IPV4/IPV6   
Provisioning Server FQDN   
> RCFG  
> TLS PSK  
> TLS PKI

Enter FQDN of provisioning server

<ENTER> = Complete Entry [ESC]= Discard Changes

39. In the **Intel(R) Remote Configuration** menu, select **Start Configuration** then press Enter. Type **Y** then press Enter.

Intel(R) Management Engine BIOS Extension v8.0.0.0061/Intel(R) ME v8.0.4.1441  
Copyright(C) 2003-12 Intel Corporation. All Rights Reserved.

**INTEL (R) REMOTE CONFIGURATION**

Start Configuration

This will activate Remote Configuration.  
Continue: (Y/N)

[↑↓] = Move highlight [ENTER] = Select Entry [ESC]= Exit

40. In the **Intel(R) Automated Setup And Configuration** menu, select **TLS PSK** then press Enter.

Intel(R) Management Engine BIOS Extension v8.0.0.0061/Intel(R) ME v8.0.4.1441  
Copyright(C) 2003-12 Intel Corporation. All Rights Reserved.

**INTEL (R) TLS PSK CONFIGURATION**

Set PID and PPS \*\*   
Delete PID and PPS \*\*

Enter PID (e.g. ABCD-1234)

<ENTER> = Complete Entry [ESC]= Exit

41. In the **Intel(R) Remote Configuration** menu, select **Set PID and PPS \*\*** then press Enter. Type PID code then press Enter.

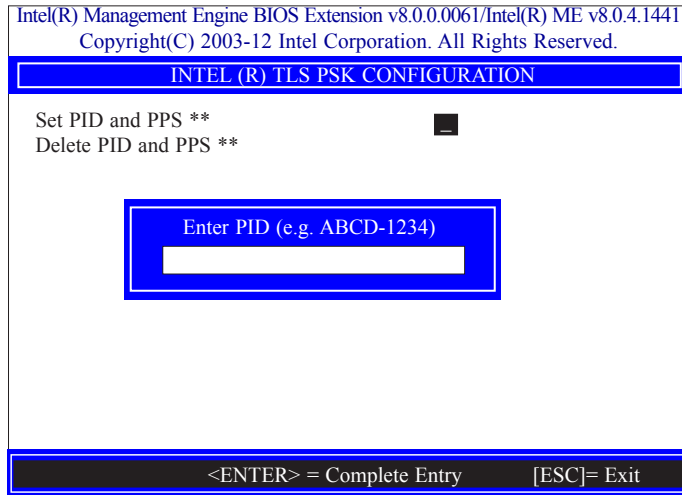

42. In the **Intel(R) Remote Configuration** menu, select **Delete PID and PPS \*\*** then press Enter. Type **Y** then press Enter.

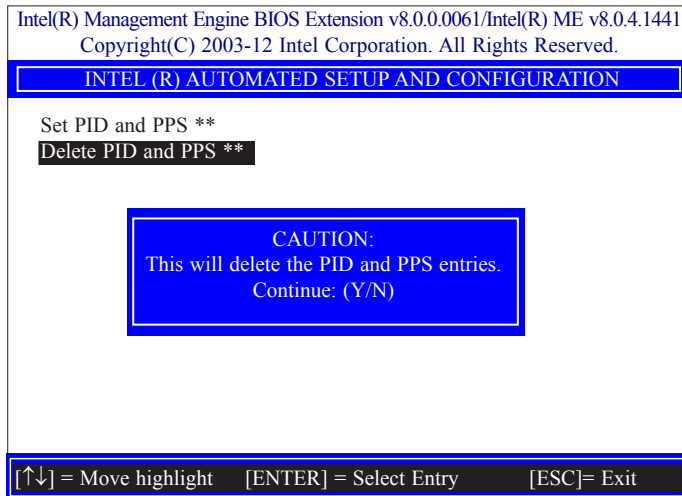

43. Select Previous Menu until you return to the **Intel(R) Automated Setup And Configuration** menu. Select **TLS PKI** then press Enter.

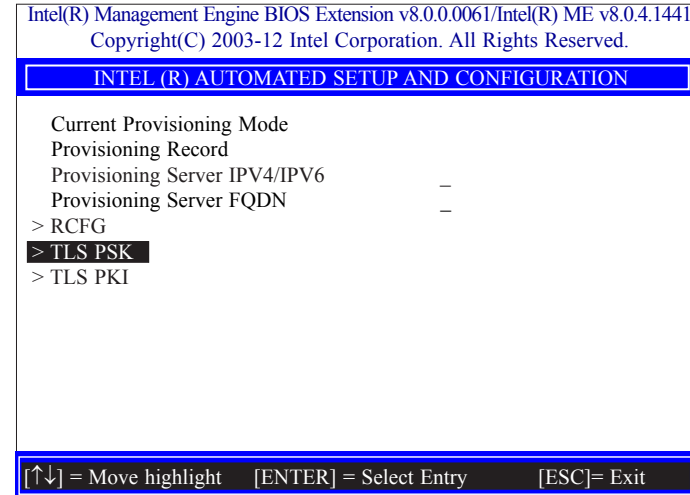

44. In the **Intel(R) Remote Configuration** menu, select **Remote Configuration \*\*** then press Enter. Select Disabled then press Enter.

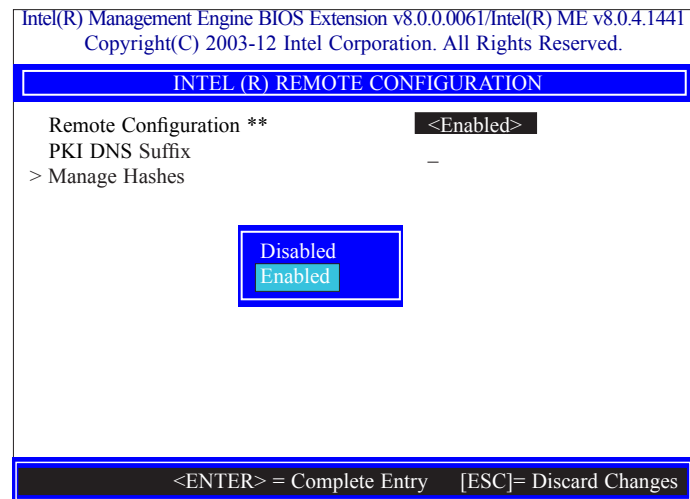

45. In the **Intel(R) Remote Configuration** menu, select **PKI DNS Suffix** then press Enter. Type PKI DNS Suffix then press Enter.

Intel(R) Management Engine BIOS Extension v8.0.0.0061/Intel(R) ME v8.0.4.1441  
Copyright(C) 2003-12 Intel Corporation. All Rights Reserved.

**INTEL (R) REMOTE CONFIGURATION**

Remote Configuration \*\* <Enabled>  
PKI DNS Suffix   
> Manage Hashes

Enter PKI DNS Suffix

<ENTER> = Complete Entry [ESC]= Discard Changes

47. Select Previous Menu until you return to the **Main Menu**. Select **Exit** then press Enter. Type **Y** then press Enter.

Intel(R) Management Engine BIOS Extension v8.0.0.0061/Intel(R) ME v8.0.4.1441  
Copyright(C) 2003-12 Intel Corporation. All Rights Reserved.

**Main Menu**

> Intel (R) ME General Settings  
> Intel (R) AMT Configuration  
MEBx Exit

Are you sure you want to exit? (Y/N)

Exit

[↑↓] = Move highlight [ENTER] = Select Entry [ESC]= Exit

46. In the **Intel(R) Remote Configuration** menu, select **Manage Hashes** then press Enter.

Intel(R) Management Engine BIOS Extension v8.0.0.0061/Intel(R) ME v8.0.4.1441  
Copyright(C) 2003-12 Intel Corporation. All Rights Reserved.

**INTEL (R) REMOTE CONFIGURATION**

Hash Name	Active	Default	Algorithm
VeriSign Class 3	Active: [*]	Default: [*]	SHA1
VeriSign Class 3	Active: [*]	Default: [*]	SHA1
Go Daddy Class 2	Active: [*]	Default: [*]	SHA1
Comodo AAA CA	Active: [*]	Default: [*]	SHA1
Starfield Class 2	Active: [*]	Default: [*]	SHA1
VeriSign Class 3	Active: [*]	Default: [*]	SHA1
VeriSign Class 3	Active: [*]	Default: [*]	SHA1
VeriSign Class 3	Active: [*]	Default: [*]	SHA1
GTE CyberTrust G1	Active: [*]	Default: [*]	SHA1
Baltimore Cyber Tr	Active: [*]	Default: [*]	SHA1
Cyber Trust Global	Active: [*]	Default: [*]	SHA1
Verizon Global Ro	Active: [*]	Default: [*]	SHA1
Entrust.net CA (2	Active: [*]	Default: [*]	SHA1

[Ins]= Add New ash [Delete] = Delete Hash [+] = Activate Hash  
[↑↓] = Move highlight [ENTER] = View Hash [Esc]= Exit



## Appendix A - Troubleshooting Checklist

### Troubleshooting Checklist

This chapter of the manual is designed to help you with problems that you may encounter with your personal computer. To efficiently troubleshoot your system, treat each problem individually. This is to ensure an accurate diagnosis of the problem in case a problem has multiple causes.

Some of the most common things to check when you encounter problems while using your system are listed below.

1. The power switch of each peripheral device is turned on.
2. All cables and power cords are tightly connected.
3. The electrical outlet to which your peripheral devices are connected is working. Test the outlet by plugging in a lamp or other electrical device.
4. The monitor is turned on.
5. The display's brightness and contrast controls are adjusted properly.
6. All add-in boards in the expansion slots are seated securely.
7. Any add-in board you have installed is designed for your system and is set up correctly.

### Monitor/Display

#### If the display screen remains dark after the system is turned on:

1. Make sure that the monitor's power switch is on.
2. Check that one end of the monitor's power cord is properly attached to the monitor and the other end is plugged into a working AC outlet. If necessary, try another outlet.
3. Check that the video input cable is properly attached to the monitor and the system's display adapter.
4. Adjust the brightness of the display by turning the monitor's brightness control knob.

#### The picture seems to be constantly moving.

1. The monitor has lost its vertical sync. Adjust the monitor's vertical sync.
2. Move away any objects, such as another monitor or fan, that may be creating a magnetic field around the display.
3. Make sure your video card's output frequencies are supported by this monitor.

#### The screen seems to be constantly wavering.

1. If the monitor is close to another monitor, the adjacent monitor may need to be turned off. Fluorescent lights adjacent to the monitor may also cause screen wavering.

### Power Supply

#### When the computer is turned on, nothing happens.

1. Check that one end of the AC power cord is plugged into a live outlet and the other end properly plugged into the back of the system.
2. Make sure that the voltage selection switch on the back panel is set for the correct type of voltage you are using.
3. The power cord may have a "short" or "open". Inspect the cord and install a new one if necessary.

### Floppy Drive

#### The computer cannot access the floppy drive.

1. The floppy diskette may not be formatted. Format the diskette and try again.
2. The diskette may be write-protected. Use a diskette that is not write-protected.
3. You may be writing to the wrong drive. Check the path statement to make sure you are writing to the targeted drive.
4. There is not enough space left on the diskette. Use another diskette with adequate storage space.

## Hard Drive

### Hard disk failure.

1. Make sure the correct drive type for the hard disk drive has been entered in the BIOS.
2. If the system is configured with two hard drives, make sure the bootable (first) hard drive is configured as Master and the second hard drive is configured as Slave. The master hard drive must have an active/bootable partition.

### Excessively long formatting period.

If your hard drive takes an excessively long period of time to format, it is likely a cable connection problem. However, if your hard drive has a large capacity, it will take a longer time to format.

## Serial Port

### The serial device (modem, printer) doesn't output anything or is outputting garbled characters.

1. Make sure that the serial device's power is turned on and that the device is on-line.
2. Verify that the device is plugged into the correct serial port on the rear of the computer.
3. Verify that the attached serial device works by attaching it to a serial port that is working and configured correctly. If the serial device does not work, either the cable or the serial device has a problem. If the serial device works, the problem may be due to the onboard I/O or the address setting.
4. Make sure the COM settings and I/O address are configured correctly.

## Keyboard

### Nothing happens when a key on the keyboard was pressed.

1. Make sure the keyboard is properly connected.
2. Make sure there are no objects resting on the keyboard and that no keys are pressed during the booting process.

## System Board

1. Make sure the add-in card is seated securely in the expansion slot. If the add-in card is loose, power off the system, re-install the card and power up the system.
2. Check the jumper settings to ensure that the jumpers are properly set.
3. Verify that all memory modules are seated securely into the memory sockets.
4. Make sure the memory modules are in the correct locations.
5. If the board fails to function, place the board on a flat surface and seat all socketed components. Gently press each component into the socket.
6. If you made changes to the BIOS settings, re-enter setup and load the BIOS defaults.