

# **HD632-H81**

## **ATX Industrial Motherboard**

### **User's Manual**

## Copyright

This publication contains information that is protected by copyright. No part of it may be reproduced in any form or by any means or used to make any transformation/adaptation without the prior written permission from the copyright holders.

This publication is provided for informational purposes only. The manufacturer makes no representations or warranties with respect to the contents or use of this manual and specifically disclaims any express or implied warranties of merchantability or fitness for any particular purpose. The user will assume the entire risk of the use or the results of the use of this document. Further, the manufacturer reserves the right to revise this publication and make changes to its contents at any time, without obligation to notify any person or entity of such revisions or changes.

Changes after the publication's first release will be based on the product's revision. The website will always provide the most updated information.

© 2018. All Rights Reserved.

## Trademarks

Product names or trademarks appearing in this manual are for identification purpose only and are the properties of the respective owners.

## FCC and DOC Statement on Class B

This equipment has been tested and found to comply with the limits for a Class B digital device, pursuant to Part 15 of the FCC rules. These limits are designed to provide reasonable protection against harmful interference when the equipment is operated in a residential installation. This equipment generates, uses and can radiate radio frequency energy and, if not installed and used in accordance with the instruction manual, may cause harmful interference to radio communications. However, there is no guarantee that interference will not occur in a particular installation. If this equipment does cause harmful interference to radio or television reception, which can be determined by turning the equipment off and on, the user is encouraged to try to correct the interference by one or more of the following measures:

- Reorient or relocate the receiving antenna.
- Increase the separation between the equipment and the receiver.
- Connect the equipment into an outlet on a circuit different from that to which the receiver is connected.
- Consult the dealer or an experienced radio TV technician for help.

### Notice:

1. The changes or modifications not expressly approved by the party responsible for compliance could void the user's authority to operate the equipment.
2. Shielded interface cables must be used in order to comply with the emission limits.

# Table of Contents

Copyright.....	2
Trademarks .....	2
FCC and DOC Statement on Class B.....	2
Warranty.....	4
Static Electricity Precautions.....	4
Safety Measures .....	4
About the Package.....	5
Chapter 1 - Introduction .....	6
Specifications .....	6
Features.....	7
Chapter 2 - Hardware Installation.....	9
Board Layout.....	9
System Memory.....	9
Installing the DIMM Module .....	10
CPU .....	11
Installing the CPU.....	12
Installing the Fan and Heat Sink.....	14
Jumper Settings .....	15
Clear CMOS Data.....	15
PS/2 Keyboard/Mouse Power Select.....	15
USB Power Select.....	16
Power-on Select.....	16
COM3 RS422/485 Select .....	17
COM1/COM2 RS232/Power Select.....	17
Digital I/O Power Select.....	18
Digital I/O Output State.....	18
SATA DOM Power Select .....	19
Rear Panel I/O Ports.....	20
PS/2 Keyboard/Mouse Port .....	20
COM (Serial) Ports.....	21
Graphics Interfaces.....	21
RJ45 LAN Ports.....	22
USB Ports.....	22
Audio .....	23

I/O Connectors.....	24
SATA (Serial ATA) Connectors.....	24
Cooling Fan Connectors.....	25
Digital I/O Connector .....	25
Power Connectors.....	26
Chassis Intrusion Connector .....	26
Front Panel Connector .....	27
Standby Power LED .....	27
Parallel Port.....	28
Expansion Slots .....	28
S/PDIF Connector .....	29
LPC Connector.....	29
Battery.....	30

Chapter 3 - BIOS Setup .....	31
Overview .....	31
AMI BIOS Setup Utility.....	32
Main .....	32
Advanced .....	32
Chipset .....	43
Boot.....	50
Security.....	51
Save & Exit .....	51
Updating the BIOS.....	52
Notice: BIOS SPI ROM .....	52

Chapter 4 - Supported Software .....	53
Chapter 5 - Digital I/O Programming Guide.....	71
Appendix A - Watchdog Sample Code.....	73
Appendix B - System Error Message.....	74
Appendix C - Troubleshooting .....	75

## Warranty

1. Warranty does not cover damages or failures that arised from misuse of the product, inability to use the product, unauthorized replacement or alteration of components and product specifications.
2. The warranty is void if the product has been subjected to physical abuse, improper installation, modification, accidents or unauthorized repair of the product.
3. Unless otherwise instructed in this user's manual, the user may not, under any circumstances, attempt to perform service, adjustments or repairs on the product, whether in or out of warranty. It must be returned to the purchase point, factory or authorized service agency for all such work.
4. We will not be liable for any indirect, special, incidental or consequential damages to the product that has been modified or altered.

## Static Electricity Precautions

It is quite easy to inadvertently damage your PC, system board, components or devices even before installing them in your system unit. Static electrical discharge can damage computer components without causing any signs of physical damage. You must take extra care in handling them to ensure against electrostatic build-up.

1. To prevent electrostatic build-up, leave the system board in its anti-static bag until you are ready to install it.
2. Wear an antistatic wrist strap.
3. Do all preparation work on a static-free surface.
4. Hold the device only by its edges. Be careful not to touch any of the components, contacts or connections.
5. Avoid touching the pins or contacts on all modules and connectors. Hold modules or connectors by their ends.



### Important:

Electrostatic discharge (ESD) can damage your processor, disk drive and other components. Perform the upgrade instruction procedures described at an ESD workstation only. If such a station is not available, you can provide some ESD protection by wearing an antistatic wrist strap and attaching it to a metal part of the system chassis. If a wrist strap is unavailable, establish and maintain contact with the system chassis throughout any procedures requiring ESD protection.

## Safety Measures

To avoid damage to the system:

- Use the correct AC input voltage range.

To reduce the risk of electric shock:

- Unplug the power cord before removing the system chassis cover for installation or servicing. After installation or servicing, cover the system chassis before plugging the power cord.



## About the Package

The package contains the following items. If any of these items are missing or damaged, please contact your dealer or sales representative for assistance.

- One HD632 motherboard
- One Serial ATA data cable
- One I/O shield

The board and accessories in the package may not come similar to the information listed above. This may differ in accordance to the sales region or models in which it was sold. For more information about the standard package in your region, please contact your dealer or sales representative.

## Optional Items

- USB port cable
- Serial ATA data cable
- COM port cable
- I/O shield

The board and accessories in the package may not come similar to the information listed above. This may differ in accordance to the sales region or models in which it was sold. For more information about the standard package in your region, please contact your dealer or sales representative.

## Before Using the System Board

Before using the system board, prepare basic system components.

If you are installing the system board in a new system, you will need at least the following internal components.

- A CPU
- Memory module
- Storage devices such as hard disk drive, etc.

You will also need external system peripherals you intend to use which will normally include at least a keyboard, a mouse and a video display monitor.

# Chapter 1 - Introduction

## Specifications

<b>Processor</b>	<ul style="list-style-type: none"> <li>LGA 1150 socket for:               <ul style="list-style-type: none"> <li>4th Generation Intel® Core™ processors                   <ul style="list-style-type: none"> <li>Intel® Core™ i7-4790S (8M Cache, up to 4.0 GHz); 65W</li> <li>Intel® Core™ i7-4770S (8M Cache, up to 3.9 GHz); 65W</li> <li>Intel® Core™ i7-4770TE (8M Cache, up to 3.3 GHz); 45W</li> <li>Intel® Core™ i5-4590S (6M Cache, up to 3.7 GHz); 65W</li> <li>Intel® Core™ i5-4590T (6M Cache, up to 3.0 GHz); 35W</li> <li>Intel® Core™ i5-4570S (6M Cache, up to 3.6 GHz); 65W</li> <li>Intel® Core™ i5-4570TE (4M Cache, up to 3.3 GHz); 35W</li> <li>Intel® Core™ i3-4360 (4M Cache, 3.7 GHz); 54W</li> <li>Intel® Core™ i3-4350T (4M Cache, 3.1 GHz); 35W</li> <li>Intel® Core™ i3-4340TE (4M Cache, 2.6 GHz); 35W</li> <li>Intel® Core™ i3-4330 (4M Cache, 3.5 GHz); 54W</li> <li>Intel® Core™ i3-4330TE (4M Cache, 2.4 GHz); 35W</li> <li>Intel® Pentium® G3420 (3M Cache, 3.2 GHz); 53W</li> <li>Intel® Pentium® G3320TE (3M Cache, 2.3 GHz); 35W</li> <li>Intel® Celeron® G1820 (2M Cache, 2.7 GHz); 53W</li> <li>Intel® Celeron® G1820TE (2M Cache, 2.2 GHz); 35W</li> </ul> </li> </ul> </li> <li>22nm process technology</li> </ul>
<b>Chipset</b>	<ul style="list-style-type: none"> <li>Intel® H81 Express Chipset</li> </ul>
<b>System Memory</b>	<ul style="list-style-type: none"> <li>Two 240-pin DDR3 DIMM sockets</li> <li>Supports DDR3 1333/1600MHz</li> <li>Supports dual channel memory interface</li> <li>Supports up to 16GB system memory</li> <li>DRAM device technologies: 1Gb, 2Gb and 4Gb DDR3 DRAM technologies are supported for x8 and x16 devices, unbuffered, non-ECC</li> </ul>
<b>Expansion Slots</b>	<ul style="list-style-type: none"> <li>1 PCIe x16 Gen 3 slot (PCIe 3.0)</li> <li>1 PCIe x4 Gen 2 slot (PCIe 2.0)</li> <li>5 PCI slots (PCI 2.3)</li> </ul>
<b>Graphics</b>	<ul style="list-style-type: none"> <li>Intel® HD Graphics</li> <li>Display ports: 1 VGA and 1 DVI-I (DVI-D signal)</li> <li>VGA and DVI-I (DVI-D signal): resolution up to 1920x1200 @ 60Hz</li> <li>Supports 6 Graphics Execution Units (EUs)</li> <li>Intel® Clear Video Technology</li> <li>DirectX Video Acceleration (DXVA) support for accelerating video processing</li> </ul>
<b>Audio</b>	<ul style="list-style-type: none"> <li>Realtek ALC886 5.1-channel High Definition Audio</li> <li>Audio outputs: Mic-in/Center+Subwoofer, Line-in/Surround and Line-out</li> <li>S/PDIF audio interface</li> </ul>
<b>LAN</b>	<ul style="list-style-type: none"> <li>2 Intel® I210 PCI Express Gigabit Ethernet controllers</li> <li>Integrated 10/100/1000 transceiver</li> <li>Fully compliant with IEEE 802.3, IEEE 802.3u, IEEE 802.3ab</li> </ul>
<b>Serial ATA</b>	<ul style="list-style-type: none"> <li>2 SATA 3.0 ports with data transfer rate up to 6Gb/s</li> <li>2 SATA 2.0 ports with data transfer rate up to 3Gb/s</li> <li>- SATA port 5 provides adequate space for SATA DOM</li> <li>Integrated Advanced Host Controller Interface (AHCI) controller</li> </ul>
<b>Trusted Platform Module - TPM* (optional)</b>	<ul style="list-style-type: none"> <li>Provides a Trusted PC for secure transactions</li> <li>Provides software license protection, enforcement and password protection</li> </ul>
<b>Rear Panel I/O Ports</b>	<ul style="list-style-type: none"> <li>1 mini-DIN-6 port for PS/2 mouse/keyboard</li> <li>2 DB-9 RS232 serial ports (RS232 and/or Power)</li> <li>1 VGA port</li> <li>1 DVI-I (DVI-D signal) port</li> <li>2 RJ45 LAN ports</li> <li>2 USB 3.0/2.0/1.1 ports</li> <li>4 USB 2.0/1.1 ports</li> <li>Line-in/Surround, Line-out, and Mic-in/Center+Subwoofer jacks</li> </ul>
<b>I/O Connectors</b>	<ul style="list-style-type: none"> <li>1 connector for 2 external USB 2.0/1.1 ports</li> <li>1 vertical USB 2.0/1.1 port</li> <li>8 connectors for 8 external serial ports (2.54mm pitch)               <ul style="list-style-type: none"> <li>7 RS232</li> <li>1 RS422/485</li> </ul> </li> <li>1 8-bit Digital I/O connector</li> <li>1 front audio connector for line-out and mic-in jacks</li> <li>1 S/PDIF connector</li> <li>1 parallel port</li> <li>4 Serial ATA ports</li> <li>1 24-pin ATX power connector</li> <li>1 8-pin 12V power connector</li> <li>1 chassis intrusion connector</li> <li>1 front panel connector</li> <li>3 fan connectors</li> </ul>
<b>BIOS</b>	<ul style="list-style-type: none"> <li>AMI BIOS               <ul style="list-style-type: none"> <li>64Mbit SPI BIOS</li> </ul> </li> </ul>
<b>WatchDog Timer</b>	<ul style="list-style-type: none"> <li>Software programmable from 1 to 255 seconds</li> </ul>
<b>Energy Efficient Design</b>	<ul style="list-style-type: none"> <li>Supports ErP Lot6 power saving* (optional)</li> <li>Supports ACPI</li> <li>System Power Management</li> <li>Wake-On-Events include:               <ul style="list-style-type: none"> <li>Wake-On-PS/2 KB/Mouse</li> <li>Wake-On-USB KB/Mouse</li> <li>Wake-On-LAN</li> <li>RTC timer to power-on the system</li> </ul> </li> <li>CPU stopped clock control</li> <li>AC power failure recovery</li> </ul>
<b>Damage Free Intelligence</b>	<ul style="list-style-type: none"> <li>Monitors CPU/system temperature and overheat alarm</li> <li>Monitors V<sub>CORE</sub>/5V/3.3V/V<sub>DIMM</sub>/12V/5VSB voltages and failure alarm</li> <li>Monitors CPU/system fan speed and failure alarm</li> <li>Read back capability that displays temperature, voltage and fan speed</li> </ul>
<b>Power Consumption</b>	<ul style="list-style-type: none"> <li>TBD</li> </ul>
<b>OS Support</b>	<ul style="list-style-type: none"> <li>Windows XP Professional x86 &amp; SP3 (32-bit) (<u>limited function</u>)</li> <li>Windows 7 Ultimate x86 &amp; SP1 (32-bit)</li> <li>Windows 7 Ultimate x64 &amp; SP1 (64-bit)</li> <li>Windows 8 Enterprise x86 (32-bit)</li> <li>Windows 8 Enterprise x64 (64-bit)</li> <li>Windows 10 IoT Enterprise</li> </ul>

<b>Temperature</b>	<ul style="list-style-type: none"> <li>• Operating: 0°C to 60°C</li> <li>• Storage: -20°C to 85°C</li> </ul>
<b>Humidity</b>	<ul style="list-style-type: none"> <li>• 5% to 90%</li> </ul>
<b>MTBF</b>	<ul style="list-style-type: none"> <li>• 568,240 hrs @ 25°C; 313,841 hrs @ 45°C</li> <li>• Calculation model: Telcordia Issue 2, Method I Case 3</li> <li>• Environment: GB, GC – Ground Benign, Controlled</li> </ul>
<b>Dimensions</b>	<ul style="list-style-type: none"> <li>• ATX form factor</li> <li>• 305mm (12") x 244mm (9.6")</li> </ul>
<b>Certification</b>	<ul style="list-style-type: none"> <li>• CE, FCC Class B, RoHS, KC</li> </ul>

**Note:**

\*Optional and is not supported in standard model. Please contact your sales representative for more information.

## Features

### • Watchdog Timer

The Watchdog Timer function allows your application to regularly “clear” the system at the set time interval. If the system hangs or fails to function, it will reset at the set time interval so that your system will continue to operate.

### • DDR3

DDR3 delivers increased system bandwidth and improved performance. It offers peak data transfer rate of up to 16Gb/s bandwidth. The advantages of DDR3 are its higher bandwidth and its increase in performance at a lower power than DDR2.

### • Graphics

The integrated Intel® HD graphics engine delivers an excellent blend of graphics performance and features to meet business needs. It provides excellent video and 3D graphics with outstanding graphics responsiveness. These enhancements deliver the performance and compatibility needed for today’s and tomorrow’s business applications. Supports VGA and DVI-I (DVI-D signal) interfaces for 2 display outputs.

### • PCI Express

PCI Express is a high bandwidth I/O infrastructure that possesses the ability to scale speeds by forming multiple lanes. The x4 PCI Express lane supports transfer rate of 4 Gigabyte per second (2 directions). The PCI Express architecture also supports high performance graphics infrastructure by enhancing the capability of a PCIe x16 Gen 3 at 16GB/s bandwidth.

### • Serial ATA

Serial ATA is a storage interface that is compliant with SATA 1.0a specification. With speed of up to 3Gb/s (SATA 2.0) and 6Gb/s (SATA 3.0), it improves hard drive performance faster than the standard parallel ATA whose data transfer rate is 100MB/s. The bandwidth of the SATA 3.0 will be limited by carrier board design.

### • Gigabit LAN

Two Intel® I210 PCI Express Gigabit LAN controllers support up to 1Gbps data transmission.

### • Audio

The Realtek ALC886 audio codec provides 5.1-channel High Definition audio output.

- **Wake-On-LAN**

This feature allows the network to remotely wake up a Soft Power Down (Soft-Off) PC. It is supported via the onboard LAN port or via a PCI LAN card that uses the PCI PME (Power Management Event) signal. However, if your system is in the Suspend mode, you can power-on the system only through an IRQ or DMA interrupt.



**Important:**  
The 5V\_standby power source of your power supply must support  $\geq 720\text{mA}$ .

- **Wake-On-USB**

This function allows you to use a USB keyboard or USB mouse to wake up a system from the S3 (STR - Suspend To RAM) state.



**Important:**  
If you are using the Wake-On-USB Keyboard/Mouse function for 2 USB ports, the 5V\_standby power source of your power supply must support  $\geq 1.5\text{A}$ . For 3 or more USB ports, the 5V\_standby power source of your power supply must support  $\geq 2\text{A}$ .

- **RTC Timer**

The RTC installed on the system board allows your system to automatically power-on on the set date and time.

- **ACPI STR**

The system board is designed to meet the ACPI (Advanced Configuration and Power Interface) specification. ACPI has energy saving features that enables PCs to implement Power Management and Plug-and-Play with operating systems that support OS Direct Power Management. ACPI when enabled in the Power Management Setup will allow you to use the Suspend to RAM function.

With the Suspend to RAM function enabled, you can power-off the system at once by pressing the power button or selecting "Standby" when you shut down Windows® without having to go through the sometimes tiresome process of closing files, applications and operating system. This is because the system is capable of storing all programs and data files during the entire operating session into RAM (Random Access Memory) when it powers-off. The operating session will resume exactly where you left off the next time you power-on the system.



**Important:**  
The 5V\_standby power source of your power supply must support  $\geq 720\text{mA}$ .

- **Wake-On-PS/2**

This function allows you to use the PS/2 keyboard or PS/2 mouse to power-on the system.



**Important:**  
The 5V\_standby power source of your power supply must support  $\geq 720\text{mA}$ .

- **Power Failure Recovery**

When power returns after an AC power failure, you may choose to either power-on the system manually or let the system power-on automatically.

- **USB**

The system board supports the new USB 3.0. It is capable of running at a maximum transmission speed of up to 5 Gbit/s (625 MB/s) and is faster than USB 2.0 (480 Mbit/s, or 60 MB/s) and USB 1.1 (12Mb/s). USB 3.0 reduces the time required for data transmission, reduces power consumption, and is backward compatible with USB 2.0. It is a marked improvement in device transfer speeds between your computer and a wide range of simultaneously accessible external Plug and Play peripherals.

# Chapter 2 - Hardware Installation

## Board Layout

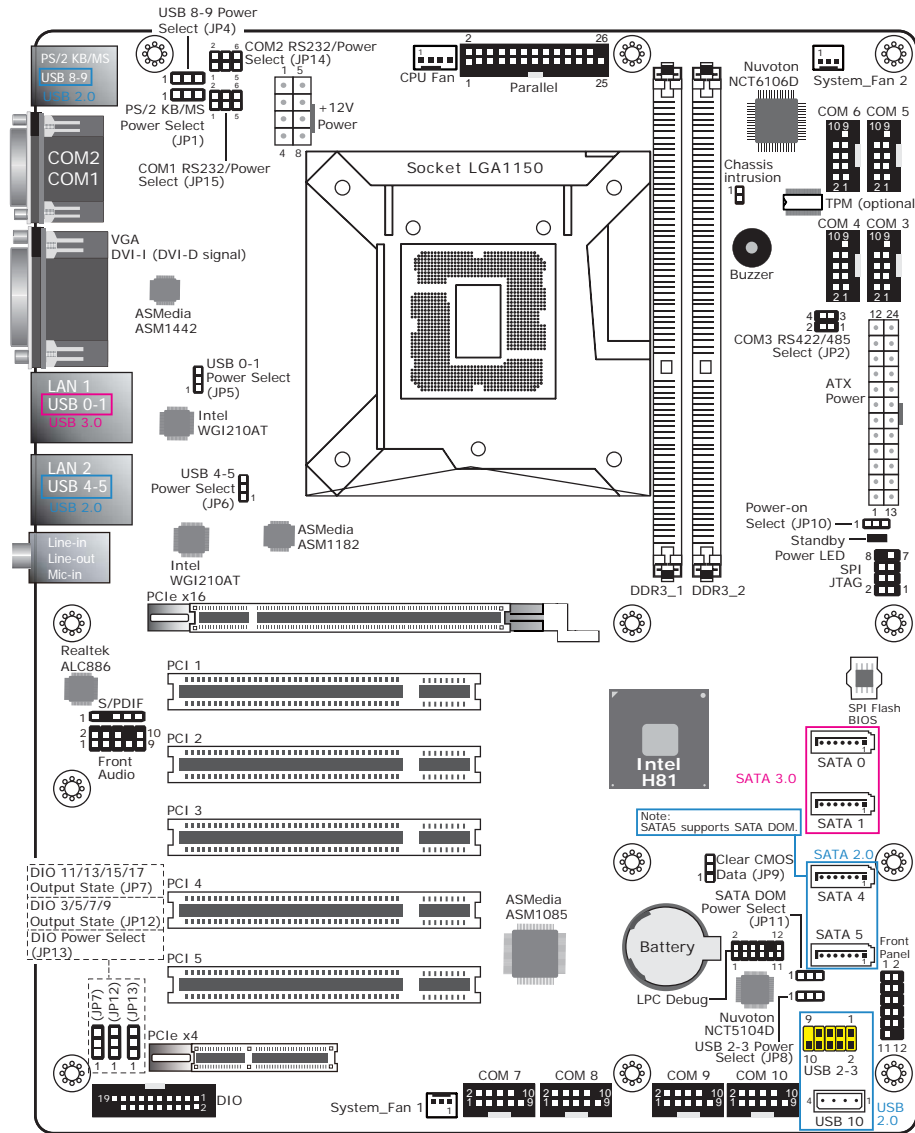

**Important:** Electrostatic discharge (ESD) can damage your board, processor, disk drives, add-in boards, and other components. Perform installation procedures at an ESD workstation only. If such a station is not available, you can provide some ESD protection by wearing an antistatic wrist strap and attaching it to a metal part of the system chassis. If a wrist strap is unavailable, establish and maintain contact with the system chassis throughout any procedures requiring ESD protection.

## System Memory



**Important:** When the Standby Power LED lit red, it indicates that there is power on the system board. Power-off the PC then unplug the power cord prior to installing any devices. Failure to do so will cause severe damage to the motherboard and components.

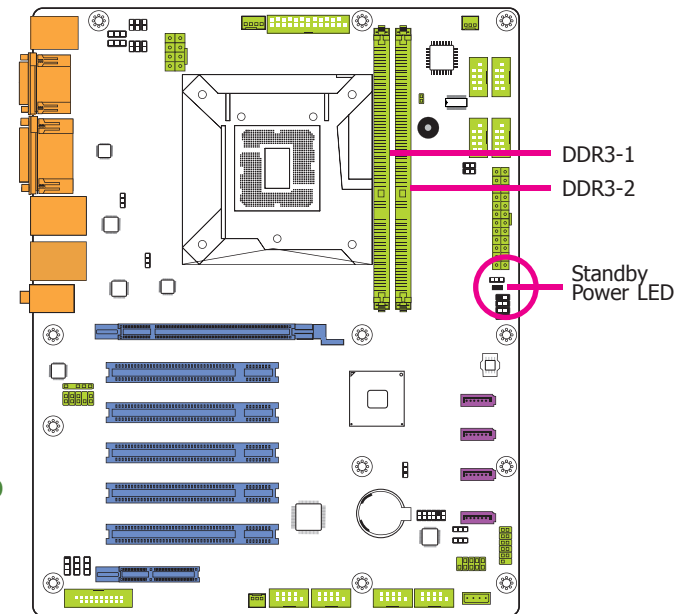

## Features

- Two 240-pin DDR3 DIMM sockets
- Supports DDR3 1333/1600MHz
- Supports dual channel memory interface
- Supports up to 16GB system memory

The system board supports the following memory interface.

### Single Channel (SC)

Data will be accessed in chunks of 64 bits (8B) from the memory channels.

### Dual Channel (DC)

Data will be accessed in chunks of 128 bits from the memory channels. Dual channel provides better system performance because it doubles the data transfer rate.

Single Channel	DIMMs are on the same channel. DIMMs in a channel can be identical or completely different. However, we highly recommend using identical DIMMs. Not all slots need to be populated.
Dual Channel	DIMMs of the same memory configuration are on different channels.



#### Important:

You can populate either Channel A or Channel B first.

## Installing the DIMM Module



#### Note:

The system board used in the following illustrations may not resemble the actual board. These illustrations are for reference only.

1. Make sure the PC and all other peripheral devices connected to it has been powered down.
2. Disconnect all power cords and cables.
3. Locate the DIMM socket on the system board.
4. Push the "ejector tabs" which are at the ends of the socket to the side.



5. Note how the module is keyed to the socket.

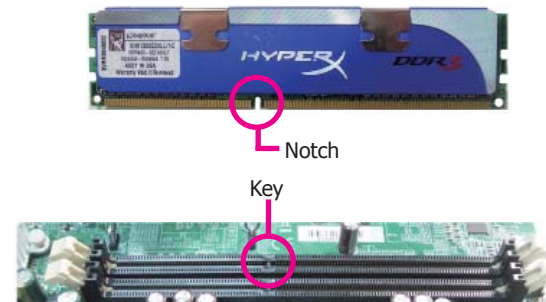

6. Grasping the module by its edges, position the module above the socket with the “notch” in the module aligned with the “key” on the socket. The keying mechanism ensures the module can be plugged into the socket in only one way.



7. Seat the module vertically, pressing it down firmly until it is completely seated in the socket.



8. The ejector tabs at the ends of the socket will automatically snap into the locked position to hold the module in place.



## CPU

The system board is equipped with a surface mount LGA 1150 socket. This socket is exclusively designed for installing a LGA 1150 packaged Intel CPU.



### Important:

1. Before you proceed, make sure (1) the LGA 1150 socket comes with a protective cap, (2) the cap is not damaged and (3) the socket's contact pins are not bent. If the cap is missing or the cap and/or contact pins are damaged, contact your dealer immediately.
2. Make sure to keep the protective cap. RMA requests will be accepted and processed only if the LGA 1150 socket comes with the protective cap.



### Note:

The system board used in the following illustrations may not resemble the actual board. These illustrations are for reference only.



## Installing the CPU

1. Make sure the PC and all other peripheral devices connected to it has been powered down.
2. Disconnect all power cords and cables.
3. Locate the LGA 1150 CPU socket on the system board.

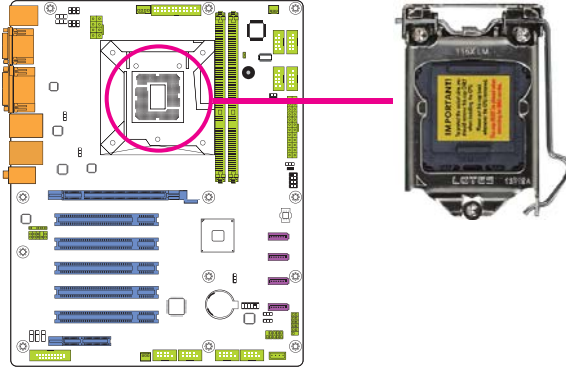

### Important:

The CPU socket must not come in contact with anything other than the CPU. Avoid unnecessary exposure. Remove the protective cap only when you are about to install the CPU.

4. Unlock the socket by pushing the load lever down, moving it sideways until it is released from the retention tab; then lift the load lever up.



5. Lifting the load lever will at the same time lift the load plate.

Lift the load lever up to the angle shown on the photo.

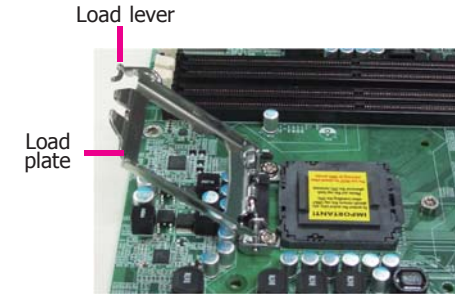

6. Remove the protective cap from the CPU socket. The cap is used to protect the CPU socket against dust and harmful particles. Remove the protective cap only when you are about to install the CPU.

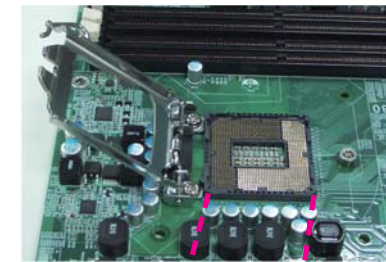

Protective cap



7. Insert the CPU into the socket. The gold triangular mark on the CPU must align with the corner of the CPU socket shown on the photo.

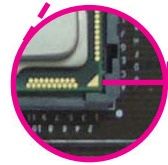
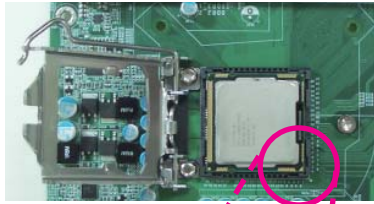

Gold triangular mark

Alignment key

The CPU's notch will at the same time fit into the socket's alignment key.

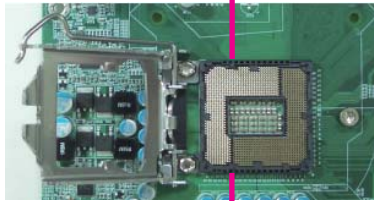

Alignment key



**Important:**

The CPU will fit in only one orientation and can easily be inserted without exerting any force.

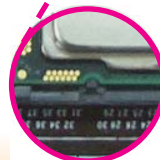

8. Close the load plate then push the load lever down.

While closing the load plate, make sure the front edge of the load plate slides under the retention knob.



Retention knob

9. Hook the load lever under the retention tab.

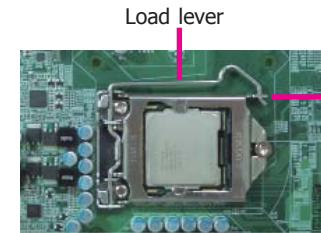

Load lever

Retention tab

## Installing the Fan and Heat Sink

The CPU must be kept cool by using a CPU fan with heat sink. Without sufficient air circulation across the CPU and heat sink, the CPU will overheat damaging both the CPU and system board.



### Note:

A boxed Intel® processor already includes the CPU fan and heat sink assembly. If your CPU was purchased separately, make sure to only use Intel®-certified fan and heat sink.

1. Before you install the fan / heat sink, you must apply a thermal paste onto the top of the CPU. The thermal paste is usually supplied when you purchase the fan / heat sink assembly. Do not spread the paste all over the surface. When you later place the heat sink on top of the CPU, the compound will disperse evenly.

Some heat sinks come with a patch of pre-applied thermal paste. Do not apply thermal paste if the fan / heat sink already has a patch of thermal paste on its underside. Peel the strip that covers the paste before you place the fan / heat sink on top of the CPU.

2. Place the heat sink on top of the CPU. The 4 push-pins around the heat sink, which are used to secure the heat sink onto the system board, must match the 4 mounting holes around the socket.

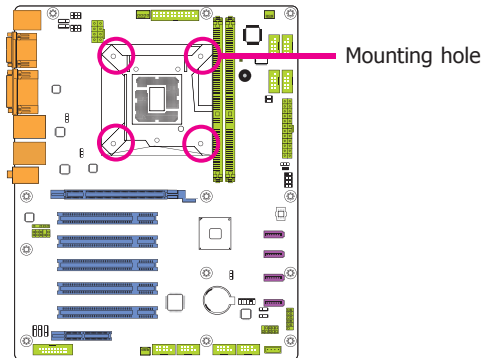

3. Orient the heat sink such that the CPU fan's cable is nearest the CPU fan connector.

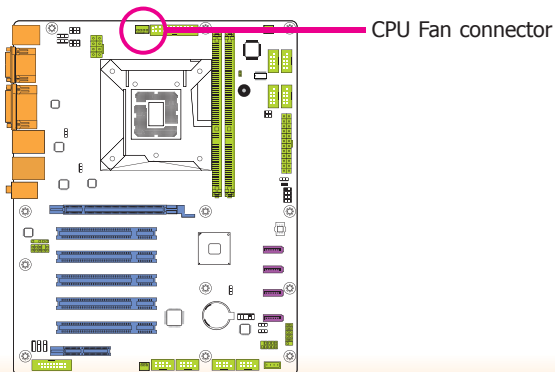

4. Rotate each push-pin according to the direction of the arrow shown on top of the pin.

Push down two pushpins that are diagonally across the heat sink. Perform the same procedure for the other two push-pins.

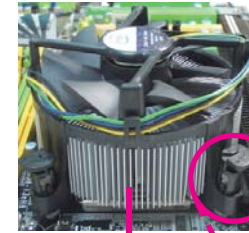

Heat sink



"Locked" position of push-pin



"Unlocked" position of push-pin

5. Connect the CPU fan's cable to the CPU fan connector on the system board.

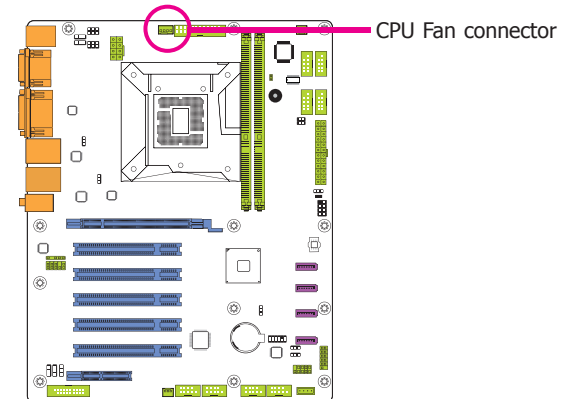

## Jumper Settings

### Clear CMOS Data

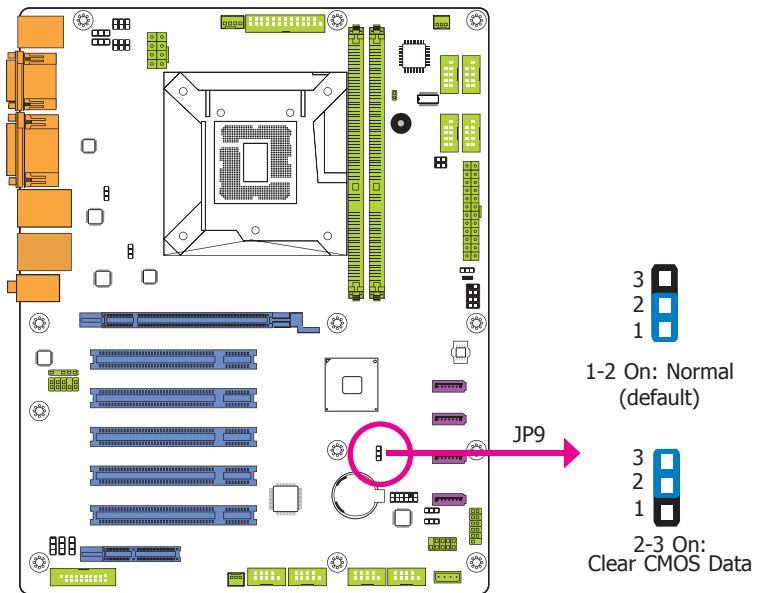

If you encounter the followings,

- CMOS data becomes corrupted.
- You forgot the supervisor or user password.

you can reconfigure the system with the default values stored in the ROM BIOS.

To load the default values stored in the ROM BIOS, please follow the steps below.

- Power-off the system and unplug the power cord.
- Set JP9 pins 2 and 3 to On. Wait for a few seconds and set JP9 back to its default setting, pins 1 and 2 On.
- Now plug the power cord and power-on the system.

### PS/2 Keyboard/Mouse Power Select

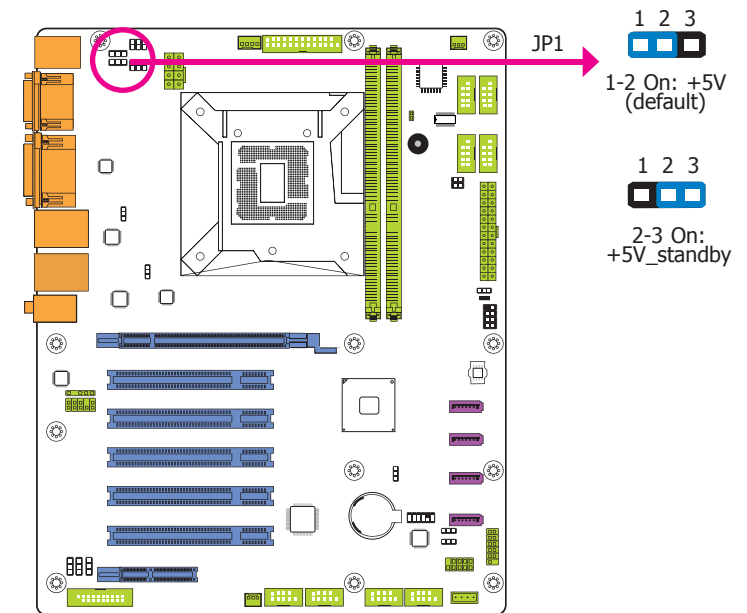

JP1 is used to select the power of the PS/2 keyboard/mouse port. Selecting +5V\_standby will allow you to use the PS/2 keyboard or PS/2 mouse to wake up the system.



**Important:**

The +5V\_standby power source of your power supply must support  $\geq 720\text{mA}$ .

### USB Power Select

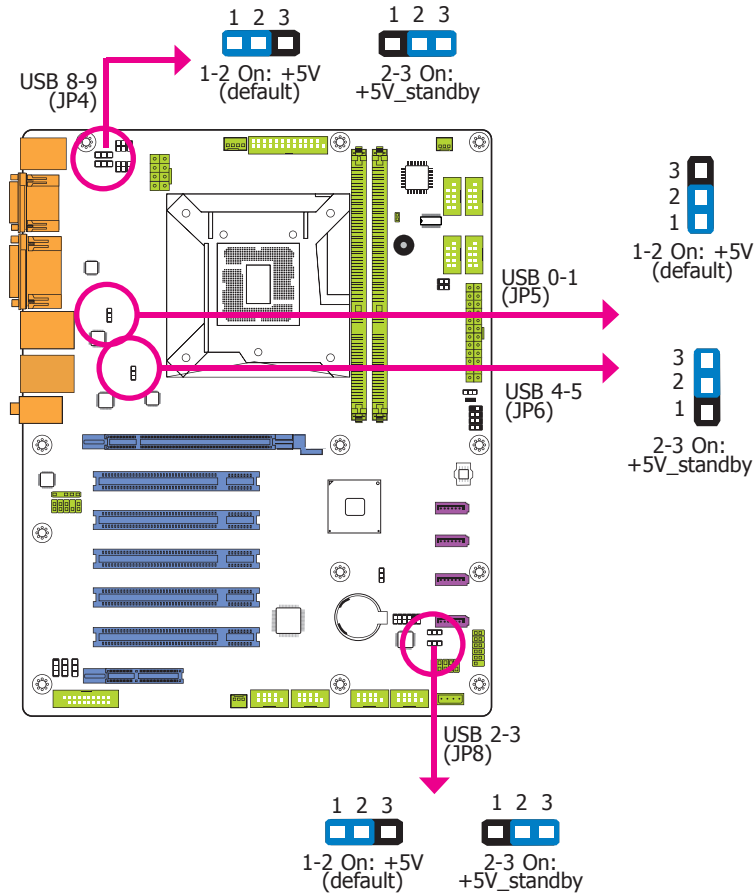

JP4, JP5, JP6 and JP8 are used to select the power of the USB devices. Selecting +5V\_standby will allow you to use a USB device to wake up the system.



**Important:**

If you are using the Wake-On-USB Keyboard/Mouse function for 2 USB ports, the +5V\_standby power source of your power supply must support  $\geq 1.5A$ . For 3 or more USB ports, the +5V\_standby power source of your power supply must support  $\geq 2A$ .

### Power-on Select

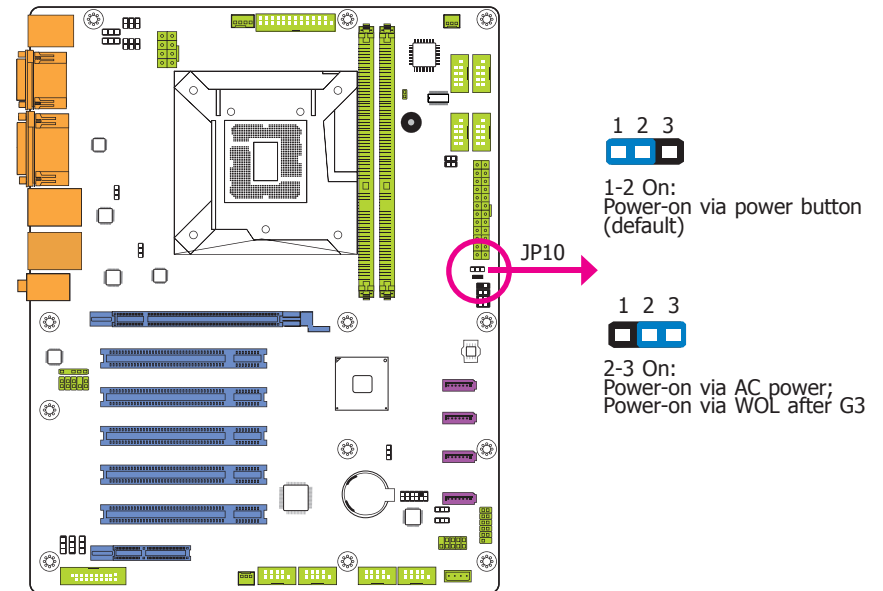

JP10 is used to select the method of powering on the system. If you want to use the power button, set pins 1 and 2 to On.

To power-on via WOL after G3:

1. Set JP10 pins 2 and 3 to On.
2. Set the "After G3" field to **Power Off/WOL**.
3. Set the "GbE Wake Up From S5" to **Enabled**.

To power-on via AC Power:

1. Set JP10 pins 2 and 3 to On.
2. Set the "After G3" field to **Power On**.

### COM3 RS422/485 Select

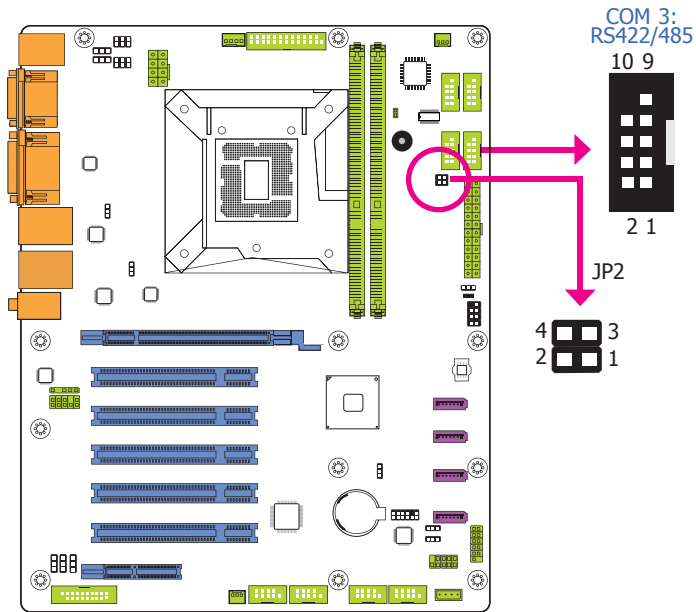

JP2 is used to configure the COM port 3 to RS422 or RS485. The pin functions of the COM port will vary according to the jumper's setting.

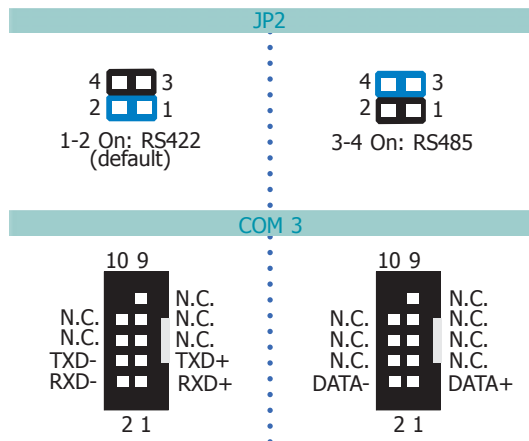

### COM1/COM2 RS232/Power Select

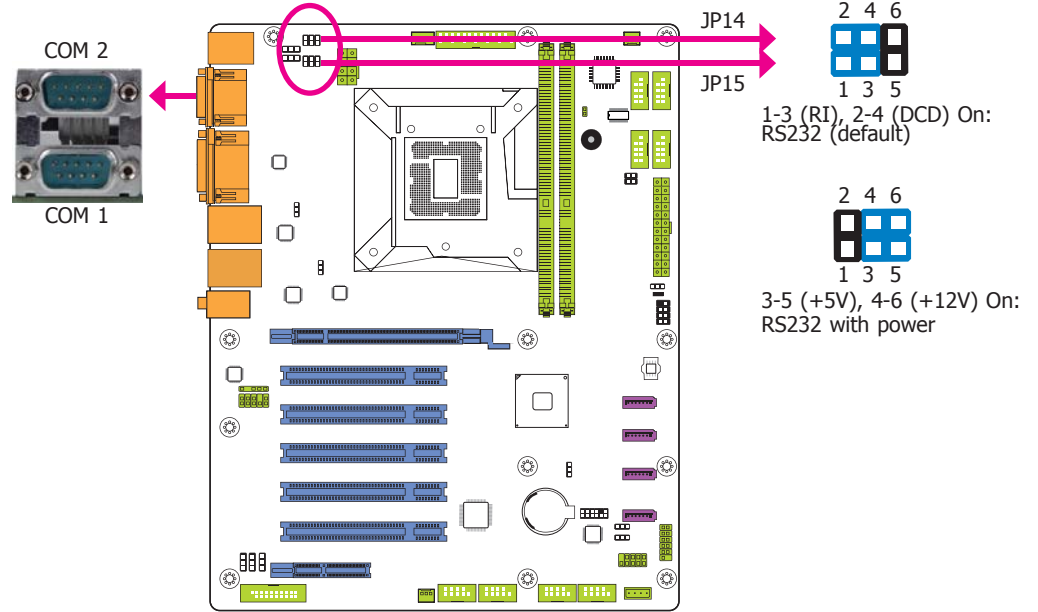

JP15 (for COM 1) and JP14 (COM 2) are used to configure Serial COM ports to pure RS232 or RS232 with power. The pin functions of COM 1 and COM 2 will vary according to JP14's and JP15's setting respectively.

## Digital I/O Power Select

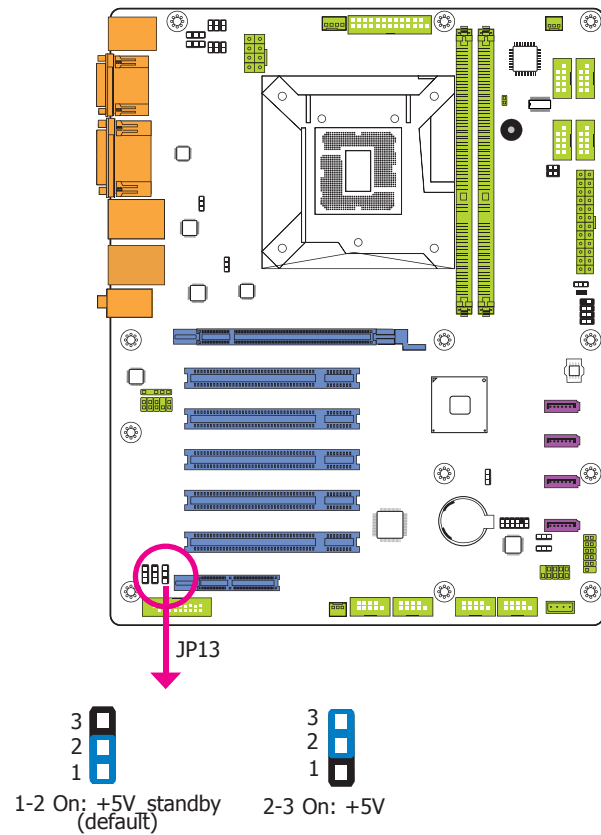

JP13 is used to select the power of DIO (Digital I/O) signal.

## Digital I/O Output State

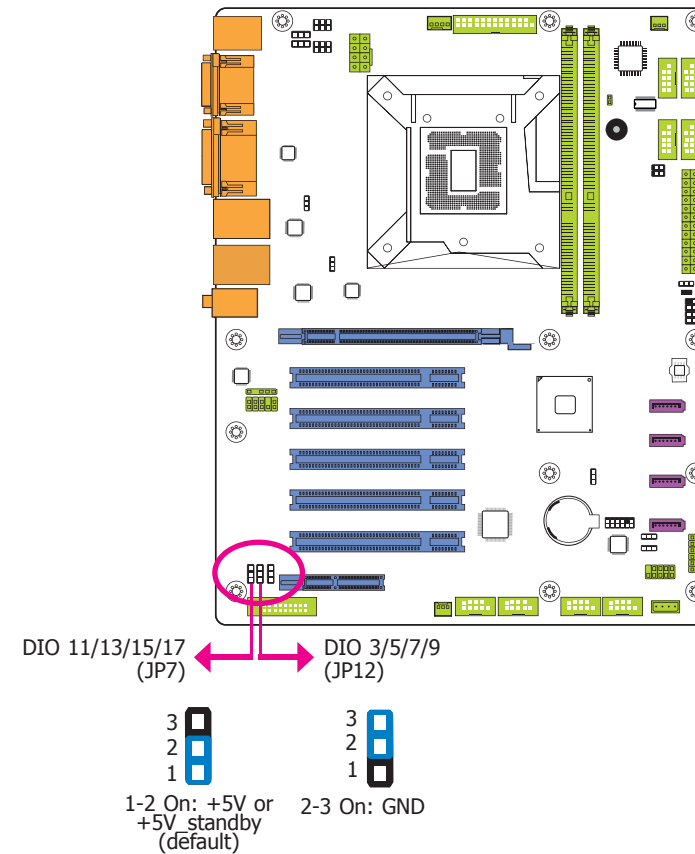

Based on the power level of DIO (Digital I/O) selected on JP13, JP12 (DIO pin 3/5/7/9) and JP7 (DIO pin 11/13/15/17) are used to select the state of DIO output: pull high or pull low. When selecting pull high, the power selection will be the same as JP13's setting.

## SATA DOM Power Select

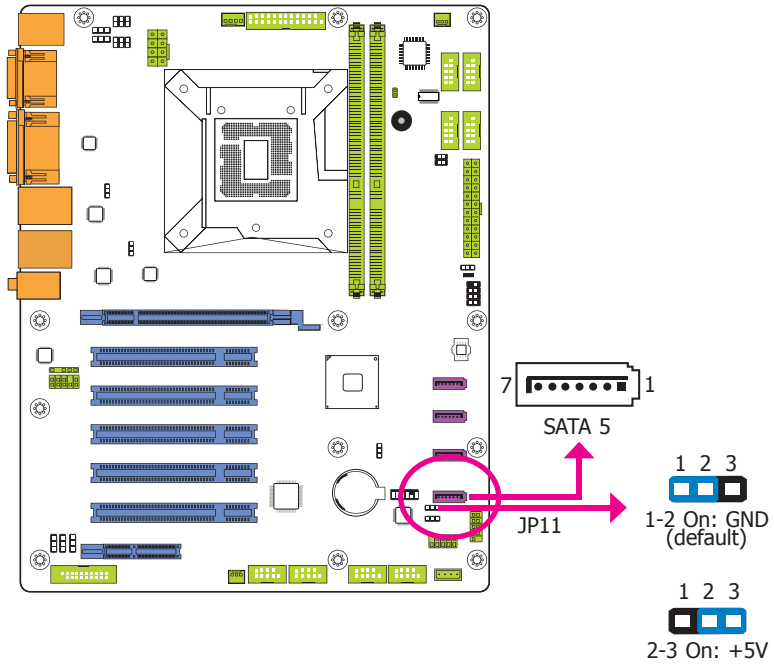

JP11 is used to select the power of SATA DOM.

**Note:**

SATA port 5 provides adequate space for SATA DOM.

## Rear Panel I/O Ports

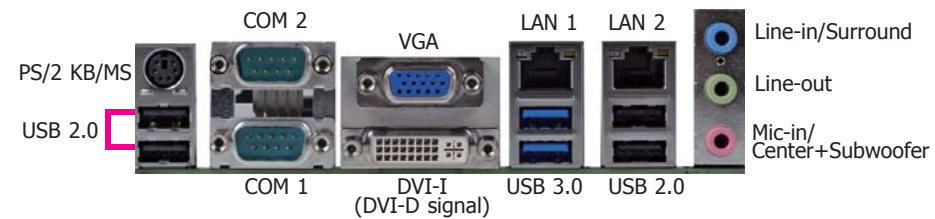

The rear panel I/O ports consist of the following:

- 1 PS/2 Keyboard/Mouse port
- 2 Serial COM ports
- 1 VGA port
- 1 DVI-I (DVI-D signal) port
- 2 RJ45 LAN ports
- 2 USB 3.0 ports
- 4 USB 2.0 ports
- Line-in/Surround jack
- Line-out jack
- Mic-in/Center+Subwoofer jack

## PS/2 Keyboard/Mouse Port

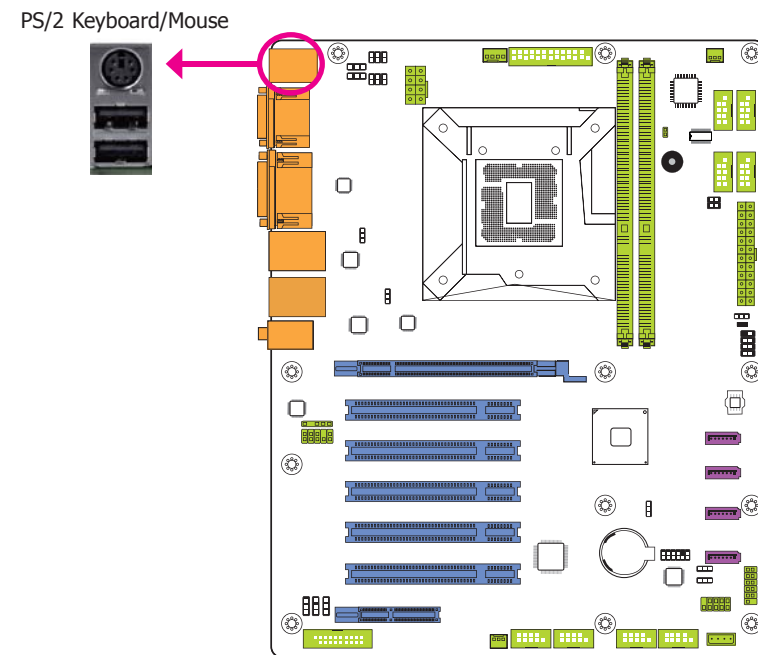

This rear I/O port is used to connect a PS/2 keyboard/mouse. The PS/2 mouse port uses IRQ12.

### Wake-On-PS/2 Keyboard/Mouse

The Wake-On-PS/2 Keyboard/Mouse function allows you to use the PS/2 keyboard or PS/2 mouse to power-on the system. To use this function:

#### • Jumper Setting

JP1 must be set to "2-3 On: +5V\_standby". Refer to "PS/2 KB/MS Power Select" in this chapter for more information.

#### • BIOS Setting

Configure the wake-up function of PS/2 keyboard/mouse in the Advanced menu ("ACPI Power Management Configuration" submenu) of the BIOS. Refer to the chapter 3 for more information.



#### Important:

The +5V\_standby power source of your power supply must support  $\geq 720\text{mA}$ .



## COM (Serial) Ports

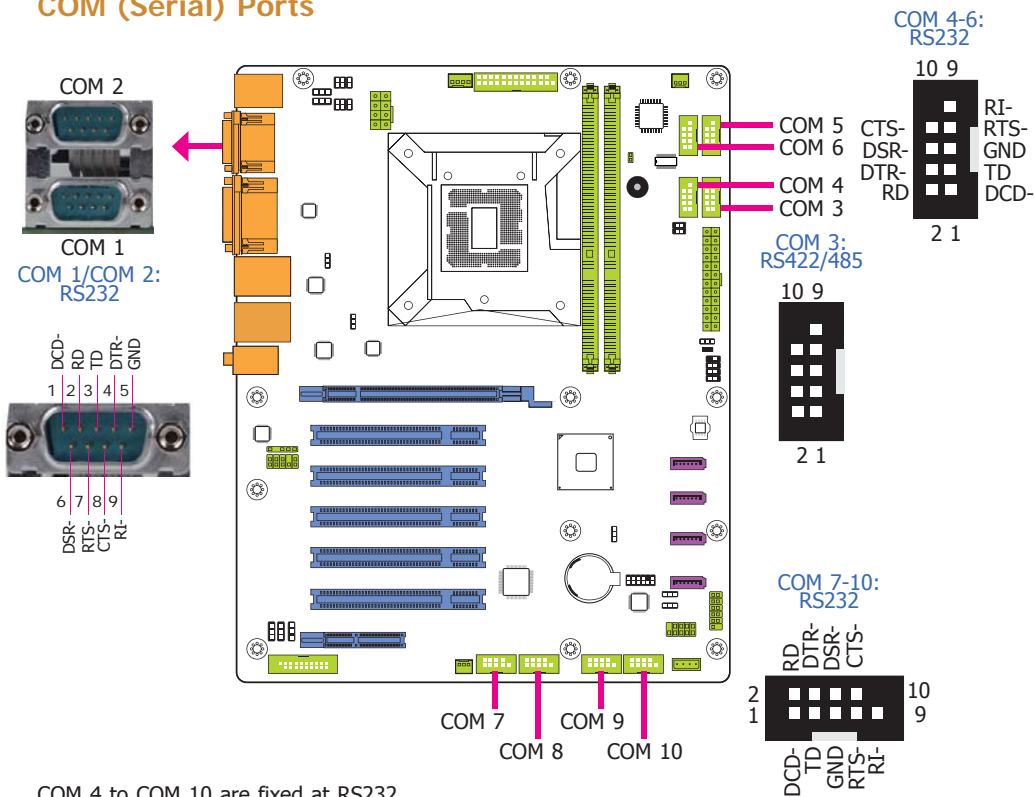

COM 4 to COM 10 are fixed at RS232.

The pin functions of COM 3 port will vary according to JP2's setting. JP15 (for COM 1) and JP14 (COM 2) are used to configure Serial COM ports to pure RS232 or RS232 with power. Refer to "COM3 RS422/RS485 Select" and "COM1/COM2 RS232/Power Select" in this chapter for more information.

The serial ports are asynchronous communication ports with 16C550A-compatible UARTs that can be used with modems, serial printers, remote display terminals, and other serial devices.

### Connecting External Serial Ports

Your COM port may come mounted on a card-edge bracket. Install the card-edge bracket to an available slot at the rear of the system chassis then insert the serial port cable to the COM connector. Make sure the colored stripe on the ribbon cable is aligned with pin 1 of the COM connector.

### BIOS Setting

Configure the serial COM ports in the Advanced menu ("Super IO Configuration" submenu) of the BIOS. Refer to the chapter 3 for more information.

## Graphics Interfaces

The display ports consist of the following:

- 1 VGA port
- 1 DVI-I (DVI-D signal) port

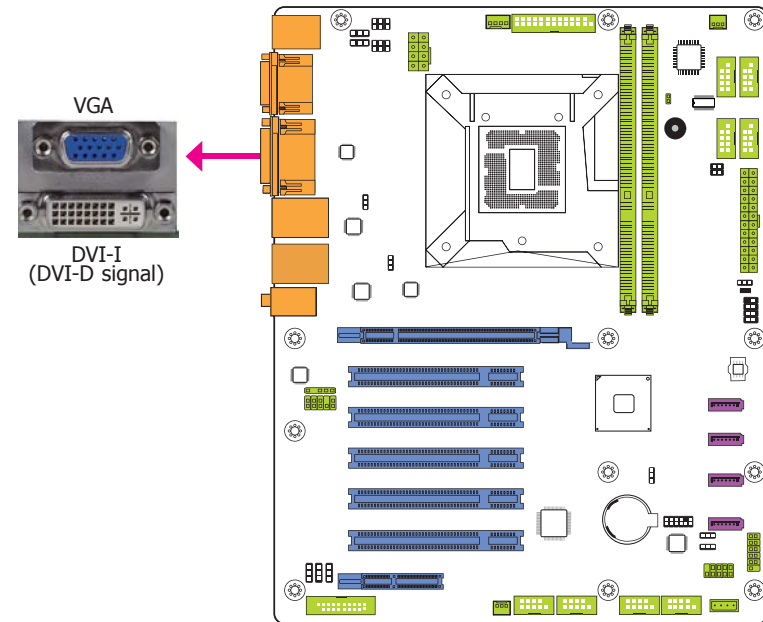

### VGA Port

The VGA port is used for connecting a VGA monitor. Connect the monitor's 15-pin D-shell cable connector to the VGA port. After you plug the monitor's cable connector into the VGA port, gently tighten the cable screws to hold the connector in place.

### DVI-I Port (DVI-D signal)

The DVI (Digital Visual Interface) port is used to connect a digital LCD monitor or LCD TV.

Connect the display device's cable connector to the DVI-I port (DVI-D signal) at location CN13. After you plug the cable connector into the DVI-I port (DVI-D signal), gently tighten the cable screws to hold the connector in place.

### BIOS Setting

Configure the display devices in the Chipset menu ("System Agent Configuration" submenu) of the BIOS. Refer to the chapter 3 for more information.

## RJ45 LAN Ports

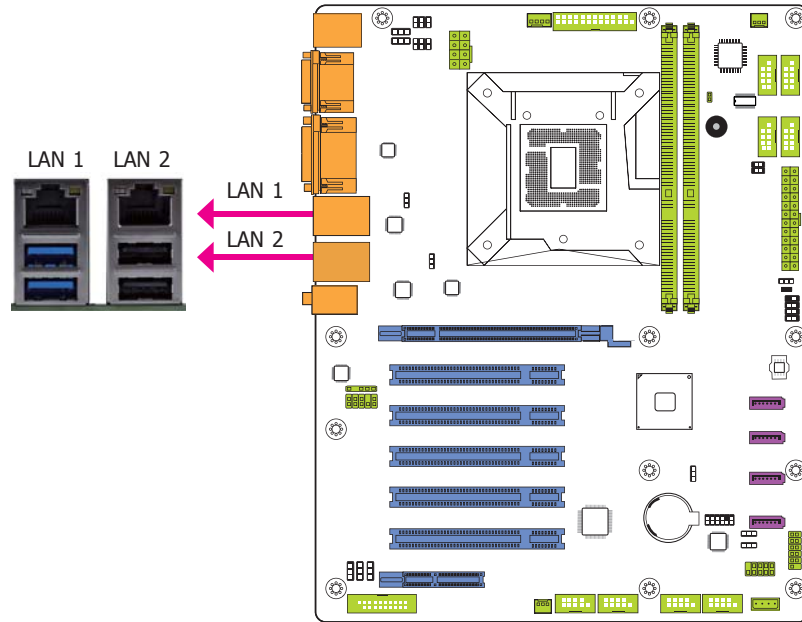

### Features

- 2 Intel® I210 PCI Express Gigabit Ethernet controllers

Two LAN ports allow the system board to connect to a local area network by means of a network hub.

### BIOS Setting

Configure the onboard LAN ports in the Chipset menu ("PCH-IO Configuration" submenu) of the BIOS. Refer to the chapter 3 for more information.

### Driver Installation

Install the LAN drivers. Refer to the chapter 4 for more information.

## USB Ports

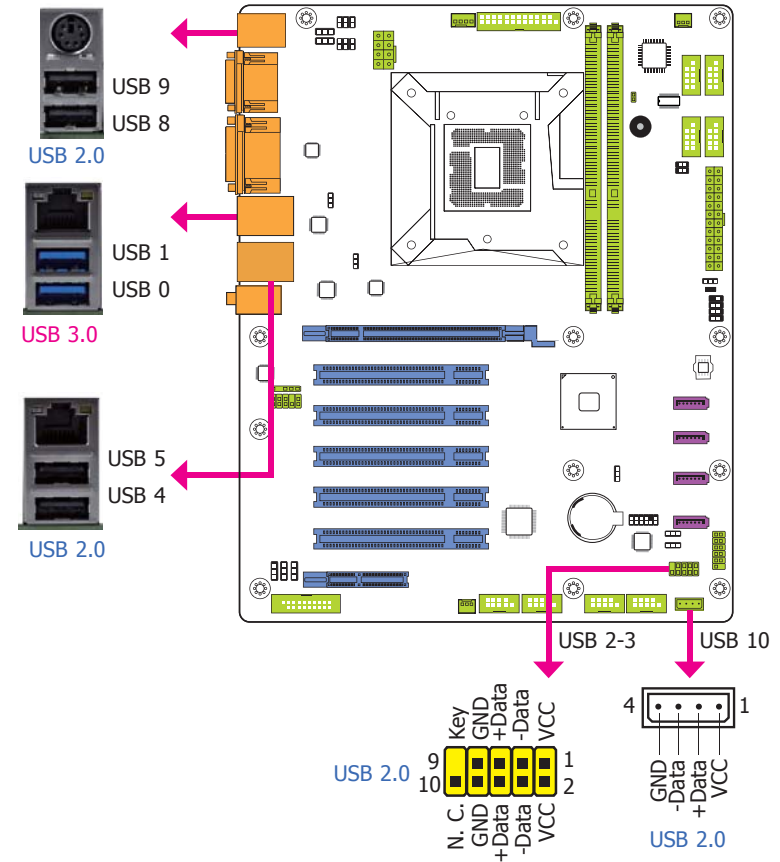

The USB device allows data exchange between your computer and a wide range of simultaneously accessible external Plug and Play peripherals.

The system board is equipped with two onboard USB 3.0/2.0/1.1 ports (USB 0-1) and four onboard USB 2.0/1.1 ports (USB 4-5/8-9). The 10-pin connector allows you to connect 2 additional USB 2.0/1.1 ports (USB 2-3) and the vertical USB connector is designed to connect 1 external USB 2.0/1.1 port (USB 10). The additional USB ports may be mounted on a card-edge bracket. Install the card-edge bracket to an available slot at the rear of the system chassis and then insert the USB port cables to a connector.

### BIOS Setting

Configure these onboard USB devices in the Advanced menu ("USB Configuration" submenu) of the BIOS. Refer to the chapter 3 for more information.

### Driver Installation

You may need to install the proper drivers in your system operation to use the USB device. Refer to your operating system's manual or documentation for more information.

### Wake-On-USB Keyboard/Mouse

The Wake-On-USB Keyboard/Mouse function allows you to use a USB keyboard or USB mouse to wake up a system from the S3 (STR - Suspend To RAM) state. To use this function:

- **Jumper Setting**

JP4, JP5, JP6 and JP8 must be set to "2-3 On: +5V\_standby". Refer to "USB Power Select" in this chapter for more information.



#### Important:

If you are using the Wake-On-USB Keyboard/Mouse function for 2 USB ports, the +5V\_standby power source of your power supply must support  $\geq 1.5A$ . For 3 or more USB ports, the +5V\_standby power source of your power supply must support  $\geq 2A$ .

## Audio

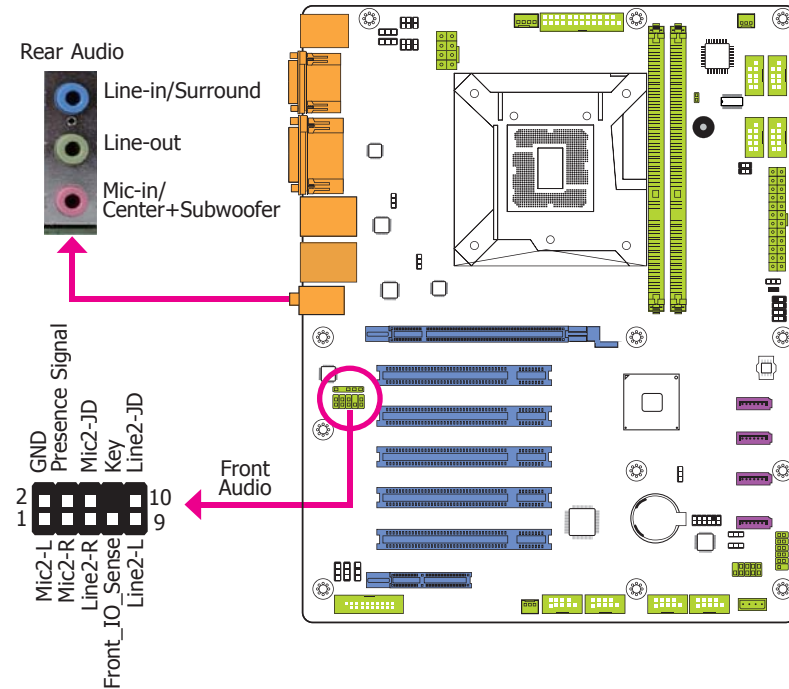

### Rear Audio

The system board is equipped with 3 audio jacks. A jack is a one-hole connecting interface for inserting a plug.

- **Line-in/Surround Jack (Light Blue)**  
This jack is used to connect any audio devices such as Hi-fi set, CD player, tape player, AM/FM radio tuner, synthesizer, etc.
- **Line-out Jack (Lime)**  
This jack is used to connect a headphone or external speakers.
- **Mic-in/Center+Subwoofer Jack (Pink)**  
This jack is used to connect an external microphone.

### Front Audio

The front audio connector allows you to connect to the second line-out and mic-in jacks that are at the front panel of your system.

### Driver Installation

Install the audio driver. Refer to the chapter 4 for more information.

## I/O Connectors

### SATA (Serial ATA) Connectors

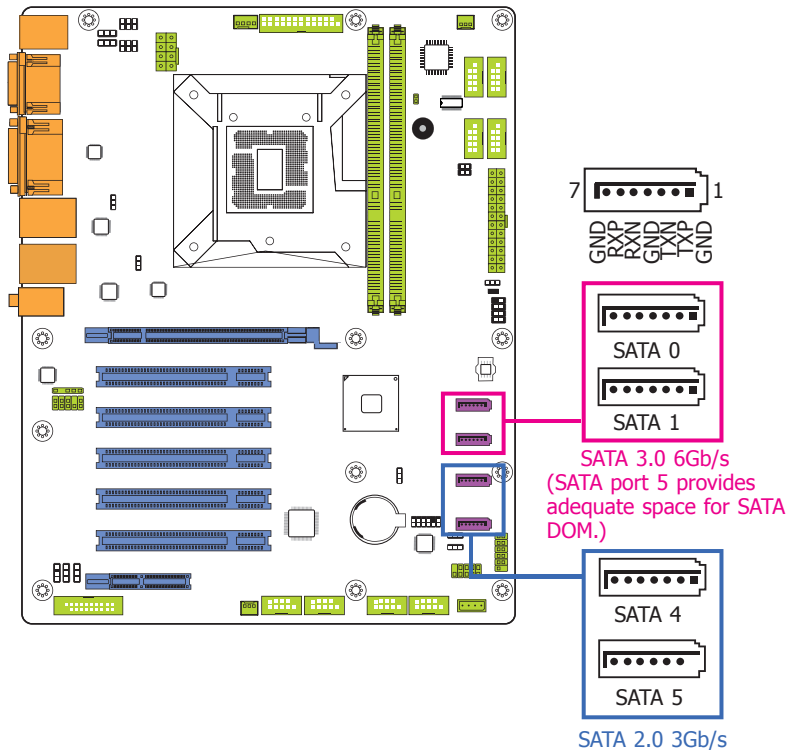

#### Features

- 4 Serial ATA ports
  - 2 SATA 3.0 ports with data transfer rate up to 6Gb/s (SATA 0 and SATA 1)
  - 2 SATA 2.0 ports with data transfer rate up to 3Gb/s (SATA 4 and SATA 5)
- Integrated Advanced Host Controller Interface (AHCI) controller

The Serial ATA connectors are used to connect Serial ATA devices. Connect one end of the Serial ATA data cable to a SATA connector and the other end to your Serial ATA device.

#### BIOS Setting

Configure the Serial ATA drives in the Advanced menu ("SATA Configuration" submenu) of the BIOS. Refer to the chapter 3 for more information.



#### Note:

Some 3rd party SATA Gen 2 speed device controllers used on the system board paired with the Intel® 8 series chipset are intermittently detected. Before using SSD devices or mSATA SSD devices, please check whether the device and the cable which are used on the system board conform to Intel's official regulations.

### Cooling Fan Connectors

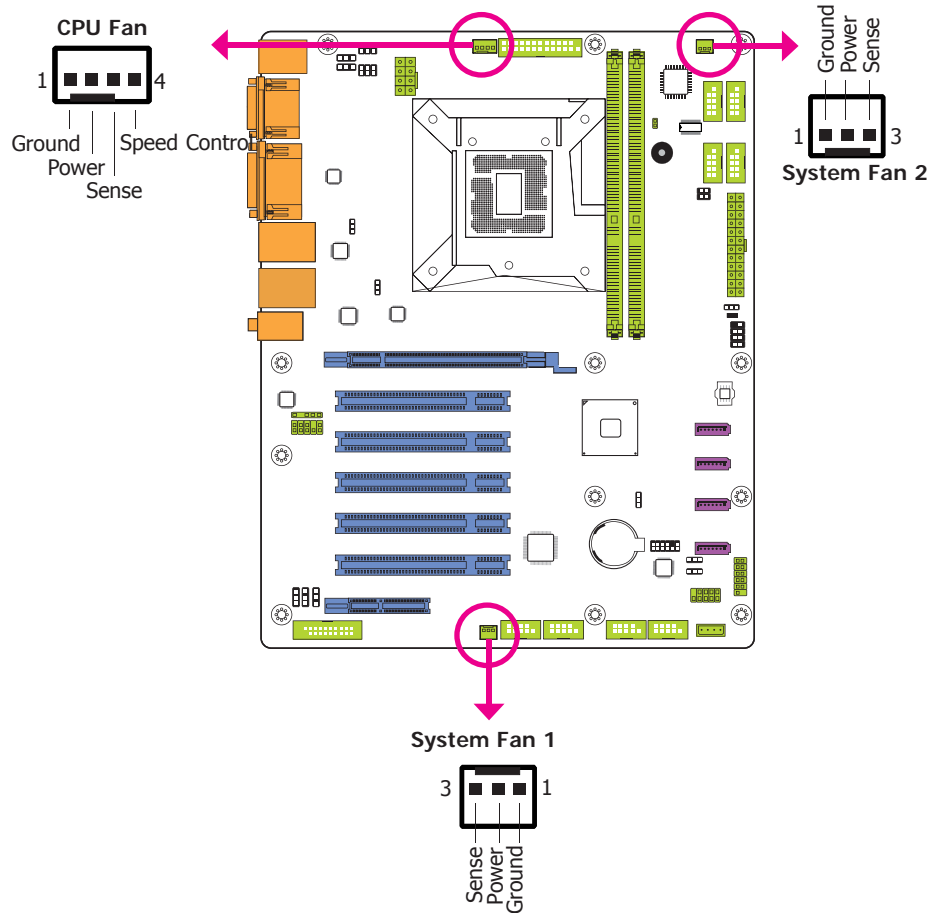

These fan connectors are used to connect cooling fans. The cooling fans will provide adequate airflow throughout the chassis to prevent overheating the CPU and system board components.

#### BIOS Setting

The Advanced menu ("PC Health Configuration" submenu) of the BIOS will display the current speed of the cooling fans. Refer to chapter 3 for more information.

### Digital I/O Connector

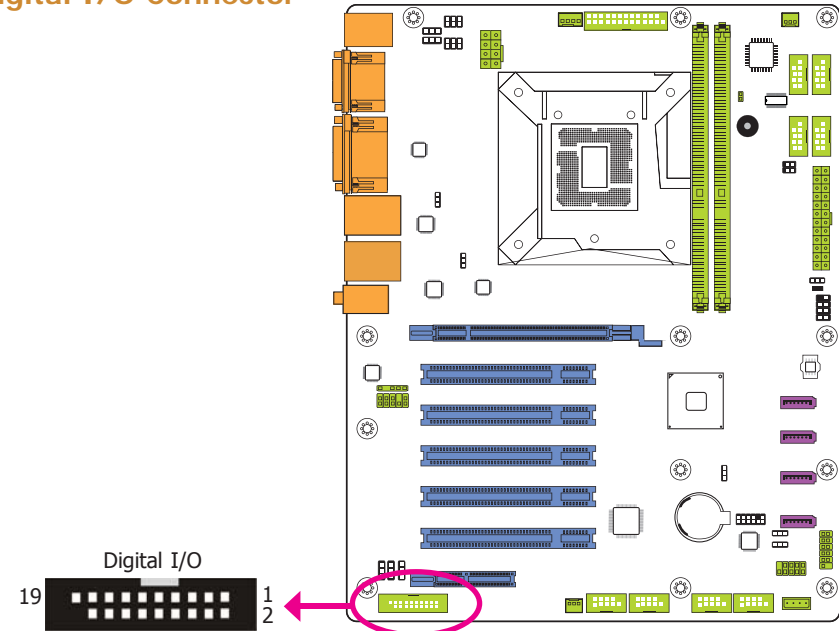

The 8-bit Digital I/O connector provides powering-on function to external devices that are connected to these connectors.

#### Digital I/O Connector

Pins	Pin Assignment	Pins	Pin Assignment
1	GND	2	+12V
3	DIO7	4	+12V
5	DIO6	6	GND
7	DIO5	8	+5V
9	DIO4	10	+5V
11	DIO3	12	GND
13	DIO2	14	+5V_Standby
15	DIO1	16	+5V_Standby
17	DIO0	18	GND
19	GND		

## Power Connectors

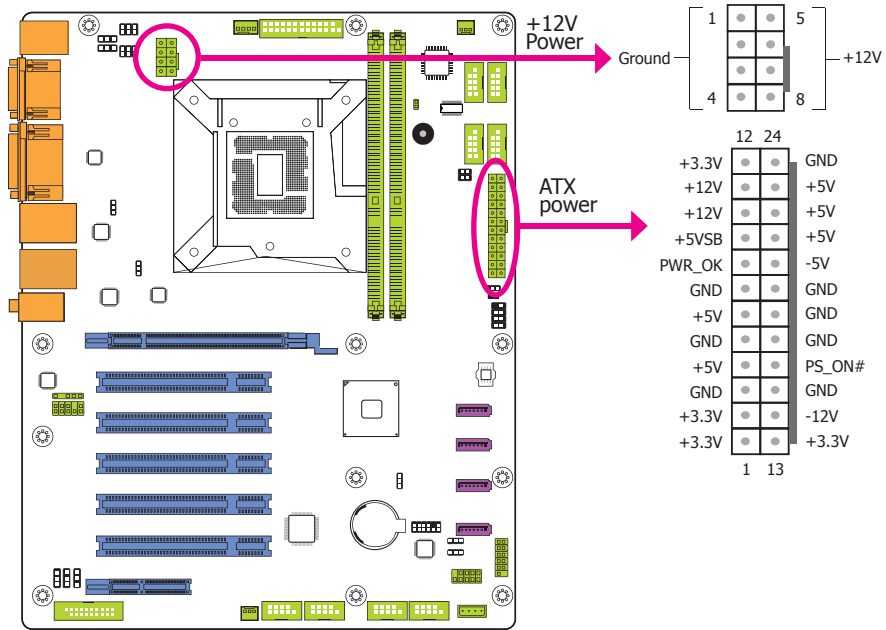

Use a power supply that complies with the ATX12V Power Supply Design Guide Version 1.1. An ATX12V power supply unit has a standard 24-pin ATX main power connector that must be inserted into the 24-pin connector. The 8-pin +12V power connector enables the delivery of more +12VDC current to the processor's Voltage Regulator Module (VRM).

The power connectors from the power supply unit are designed to fit the 24-pin and 8-pin connectors in only one orientation. Make sure to find the proper orientation before plugging the connectors.

The system board requires a minimum of 300 Watt power supply to operate. Your system configuration (CPU power, amount of memory, add-in cards, peripherals, etc.) may exceed the minimum power requirement. To ensure that adequate power is provided, we strongly recommend that you use a minimum of 400 Watt (or greater) power supply.

**Important:**

Insufficient power supplied to the system may result in instability or the add-in boards and peripherals not functioning properly. Calculating the system's approximate power usage is important to ensure that the power supply meets the system's consumption requirements.

## Chassis Intrusion Connector

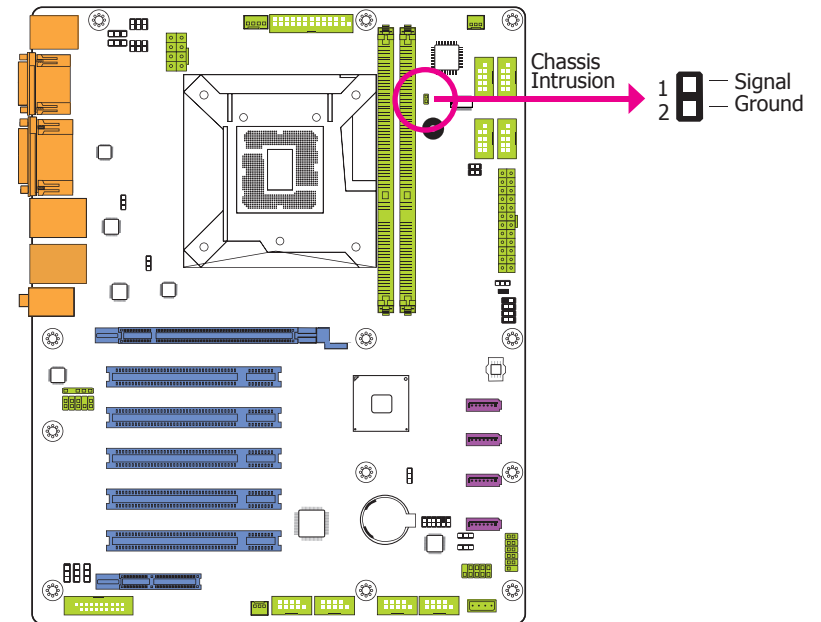

The board supports the chassis intrusion detection function. Connect the chassis intrusion sensor cable from the chassis to this connector. When the system's power is on and a chassis intrusion occurred, an alarm will sound. When the system's power is off and a chassis intrusion occurred, the alarm will sound only when the system restarts.

### Front Panel Connector

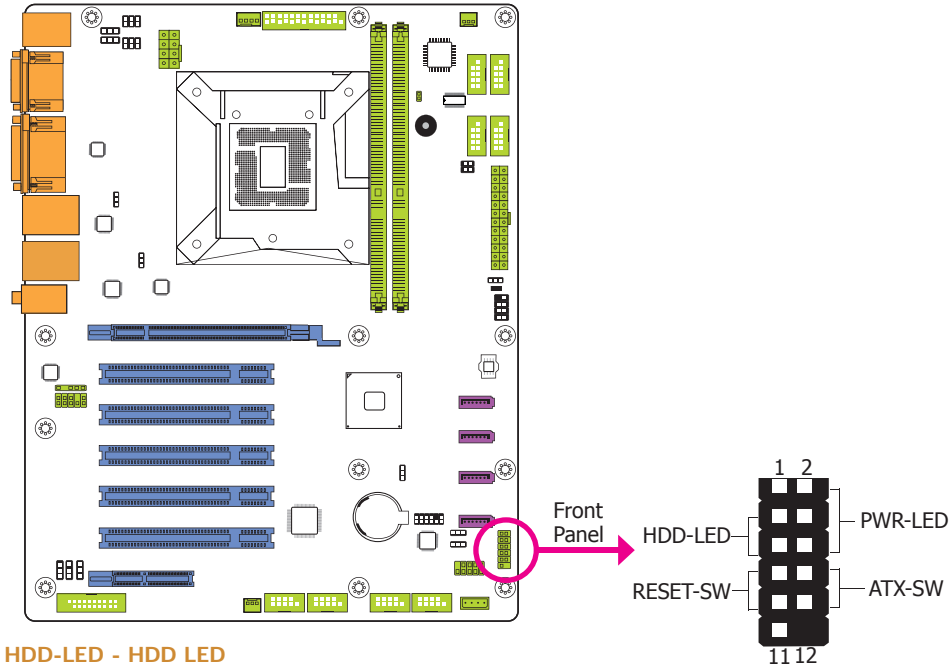

#### HDD-LED - HDD LED

This LED will light when the hard drive is being accessed.

#### RESET SW - Reset Switch

This switch allows you to reboot without having to power off the system.

#### ATX-SW - ATX Power Switch

This switch is used to power on or off the system.

#### PWR-LED - Power/Standby LED

When the system's power is on, this LED will light. When the system is in the S1 (POS - Power On Suspend) state, it will blink every second. When the system is in the S3 (STR - Suspend To RAM) state, it will blink every 4 seconds.

	Pin	Pin Assignment		Pin	Pin Assignment
HDD-LED	3	HDD Power	PWR-LED	2	LED Power
	5	Signal		4	LED Power
RESET SW	7	Ground	ATX-SW	6	Signal
	9	RST Signal		8	Ground
	11	N.C.		10	Signal

### Standby Power LED

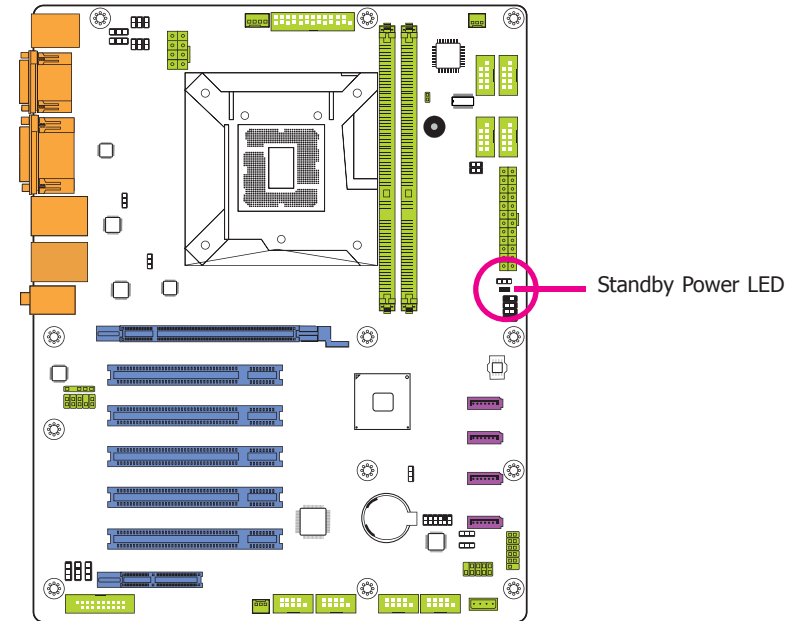

This LED will lit red when the system is in the standby mode. It indicates that there is power on the system board. Power-off the PC and then unplug the power cord prior to installing any devices. Failure to do so will cause severe damage to the motherboard and components.

## Parallel Port

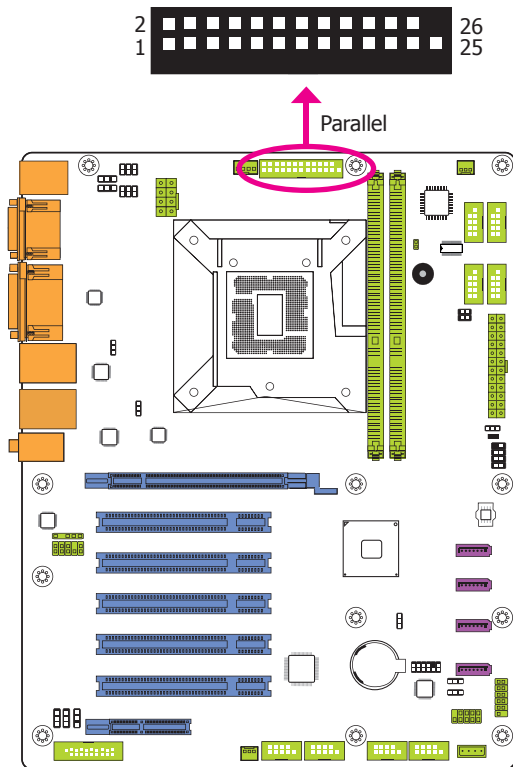

The 25-pin connector is used to connect an external parallel port. The parallel port connects your PC to a parallel printer. It supports SPP, ECP and EPP.

<b>SPP (Standard Parallel Port)</b>	Allows normal speed operation but in one direction only.
<b>ECP (Extended Capabilities Port)</b>	Allows parallel port to operate in bidirectional mode and at a speed faster than the SPP's data transfer rate.
<b>EPP (Enhanced Parallel Port)</b>	Allows bidirectional parallel port operation at maximum speed.

## Expansion Slots

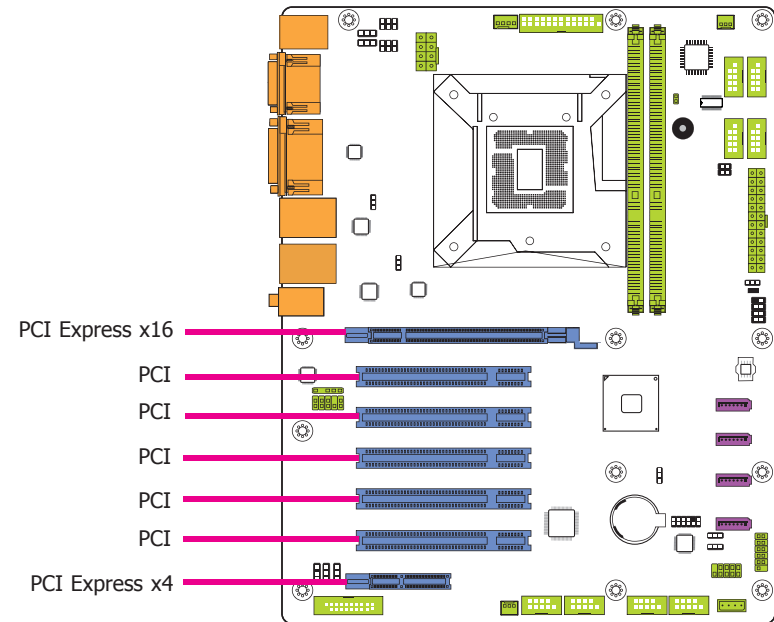

### PCI Express x16 Slot

Install PCI Express x16 graphics card, that comply to the PCI Express specifications, into the PCI Express x16 slot. To install a graphics card into the x16 slot, align the graphics card above the slot then press it down firmly until it is completely seated in the slot. The retaining clip of the slot will automatically hold the graphics card in place.

### PCI Slot

The PCI slot supports expansion cards that comply with PCI specifications. You can install a PCI expansion card or a customized riser card designed for only 2 PCI slots expansion (for low profile PCI card only) into the PCI slot.

### PCI Express x4 Slot

Install PCI Express cards such as network cards or other cards that comply to the PCI Express specifications into the PCI Express x4 slot.



## S/PDIF Connector

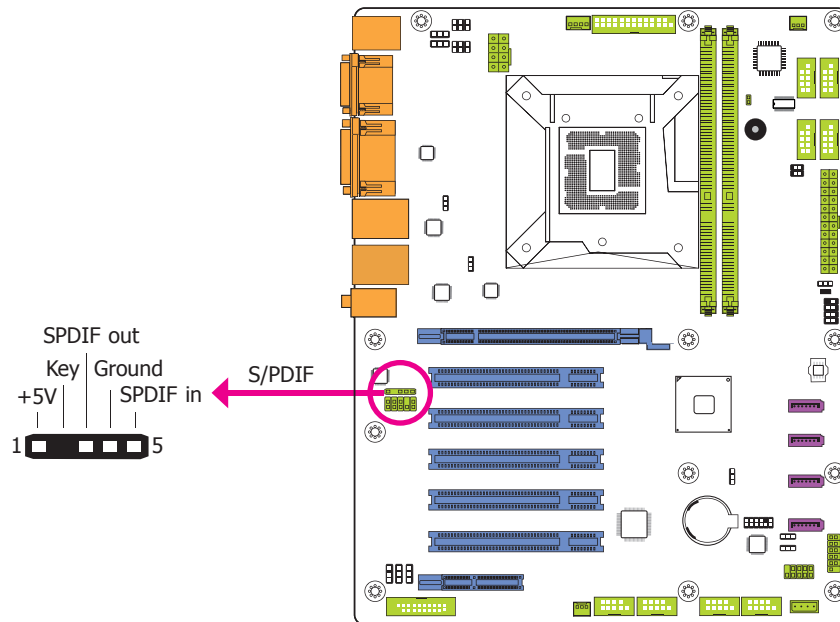

The S/PDIF connector is used to connect an external S/PDIF port. Your S/PDIF port may be mounted on a card-edge bracket. Install the card-edge bracket to an available slot at the rear of the system chassis then connect the audio cable to the S/PDIF connector. Make sure pin 1 of the audio cable is aligned with pin 1 of the S/PDIF connector.

## LPC Connector

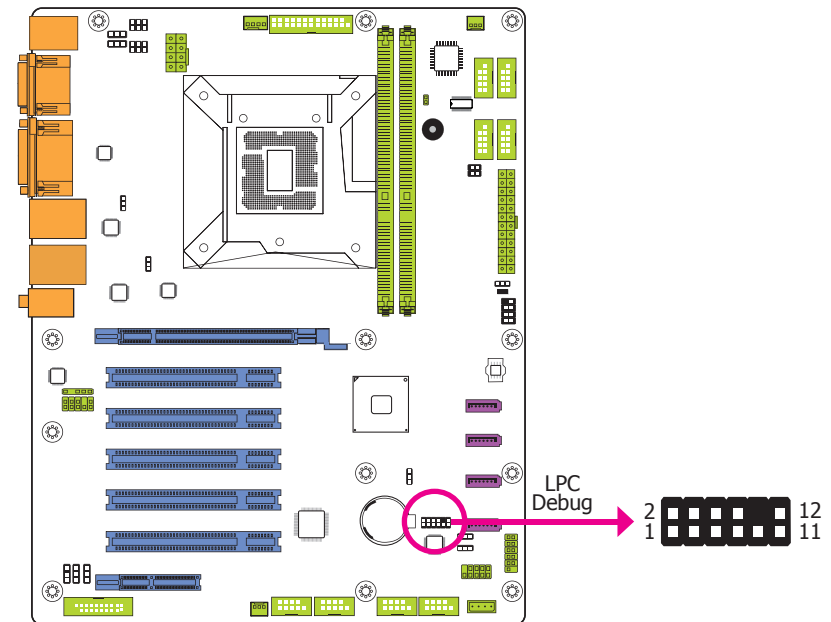

The Low Pin Count Interface was defined by Intel® Corporation to facilitate the industry's transition towards legacy free systems. It allows the integration of low-bandwidth legacy I/O components within the system, which are typically provided by a Super I/O controller. Furthermore, it can be used to interface firmware hubs, and embedded controller solutions. Data transfer on the LPC bus is implemented over a 4 bit serialized data interface, which uses a 33MHz LPC bus clock. For more information about LPC bus refer to the Intel® Low Pin Count Interface Specification Revision 1.1'.

## Battery

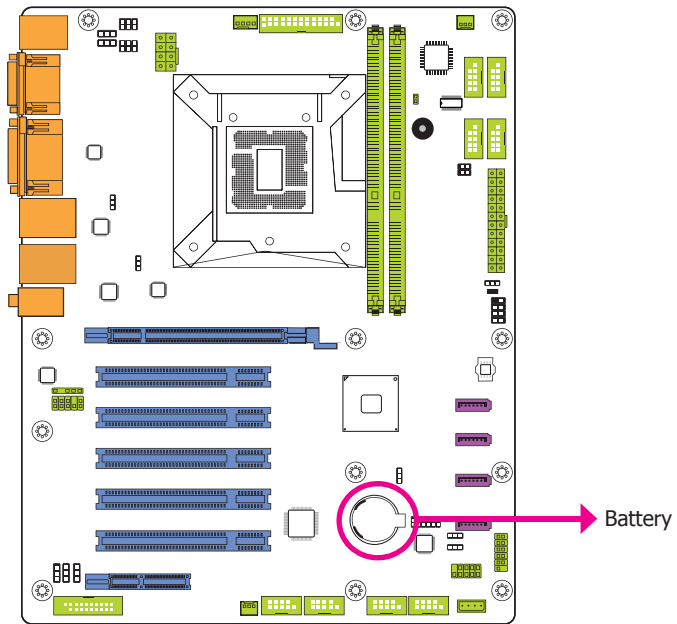

The lithium ion battery powers the real-time clock and CMOS memory. It is an auxiliary source of power when the main power is shut off.

### Safety Measures

- Danger of explosion if battery incorrectly replaced.
- Replace only with the same or equivalent type recommended by the manufacturer.
- Dispose of used batteries according to local ordinance.

## Chapter 3 - BIOS Setup

### Overview

The BIOS is a program that takes care of the basic level of communication between the CPU and peripherals. It contains codes for various advanced features found in this system board. The BIOS allows you to configure the system and save the configuration in a battery-backed CMOS so that the data retains even when the power is off. In general, the information stored in the CMOS RAM of the EEPROM will stay unchanged unless a configuration change has been made such as a hard drive replaced or a device added.

It is possible that the CMOS battery will fail causing CMOS data loss. If this happens, you need to install a new CMOS battery and reconfigure the BIOS settings.



#### Note:

The BIOS is constantly updated to improve the performance of the system board; therefore the BIOS screens in this chapter may not appear the same as the actual one. These screens are for reference purpose only.

### Default Configuration

Most of the configuration settings are either predefined according to the Load Optimal Defaults settings which are stored in the BIOS or are automatically detected and configured without requiring any actions. There are a few settings that you may need to change depending on your system configuration.

### Entering the BIOS Setup Utility

The BIOS Setup Utility can only be operated from the keyboard and all commands are keyboard commands. The commands are available at the right side of each setup screen.

The BIOS Setup Utility does not require an operating system to run. After you power up the system, the BIOS message appears on the screen and the memory count begins. After the memory test, the message "Press DEL to run setup" will appear on the screen. If the message disappears before you respond, restart the system or press the "Reset" button. You may also restart the system by pressing the <Ctrl> <Alt> and <Del> keys simultaneously.

### Legends

Keys	Function
Right and Left arrows	Moves the highlight left or right to select a menu.
Up and Down arrows	Moves the highlight up or down between submenu or fields.
<Esc>	Exit to the BIOS Setup Utility.
+ (plus key)	Scrolls forward through the values or options of the highlighted field.
- (minus key)	Scrolls backward through the values or options of the highlighted field.
Tab	Select a field.
<F1>	Displays general help
<F2>	Previous values
<F3>	Optimized defaults
<F4>	Saves and resets the setup program.
<Enter>	Press <Enter> to enter the highlighted submenu.

### Scroll Bar

When a scroll bar appears to the right of the setup screen, it indicates that there are more available fields not shown on the screen. Use the up and down arrow keys to scroll through all the available fields.

### Submenu

When "►" appears on the left of a particular field, it indicates that a submenu which contains additional options are available for that field. To display the submenu, move the highlight to that field and press <Enter>.

## AMI BIOS Setup Utility

### Main

The Main menu is the first screen that you will see when you enter the BIOS Setup Utility.

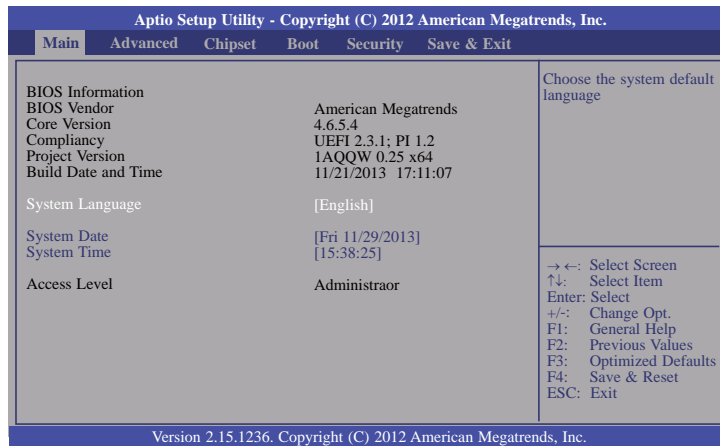

#### System Date

The date format is <day>, <month>, <date>, <year>. Day displays a day, from Sunday to Saturday. Month displays the month, from January to December. Date displays the date, from 1 to 31. Year displays the year, from 1980 to 2099.

#### System Time

The time format is <hour>, <minute>, <second>. The time is based on the 24-hour military-time clock. For example, 1 p.m. is 13:00:00. Hour displays hours from 00 to 23. Minute displays minutes from 00 to 59. Second displays seconds from 00 to 59.

### Advanced

The Advanced menu allows you to configure your system for basic operation. Some entries are defaults required by the system board, while others, if enabled, will improve the performance of your system or let you set some features according to your preference.



#### Important:

Setting incorrect field values may cause the system to malfunction.

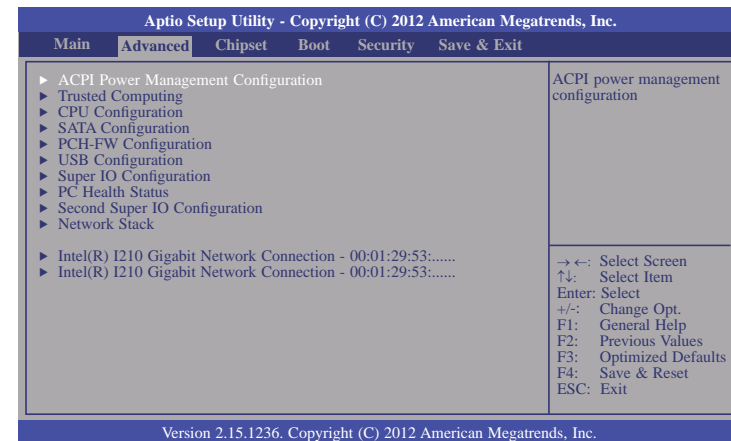

## ACPI Power Management Configuration

This section is used to configure the ACPI Power Management.

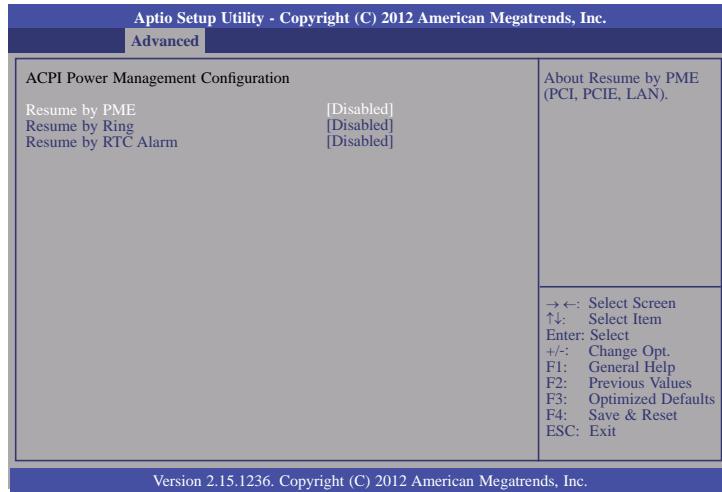

### Resume by PME

Enables this field to use the PME signal to wake up the system.

### Resume by Ring

Enables this field to use the Ring signal to wake up the system.

### Resume by RTC Alarm

When Enabled, the system uses the RTC to generate a wakeup event.

## Trusted Computing

This section configures settings relevant to Trusted Computing innovations.

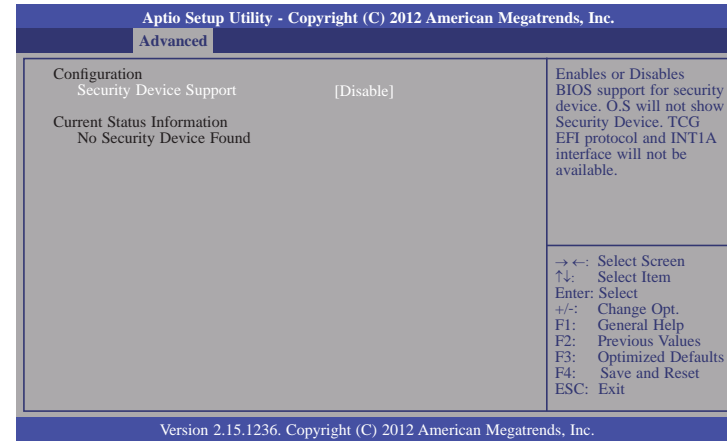

### Security Device Support

This field is used to enable or disable BIOS supporting for the security device. O.S will not show the security device. TCG EFI protocol and INT1A interface will not be available.

## CPU Configuration

This section is used to configure the CPU. It will also display the detected CPU information.

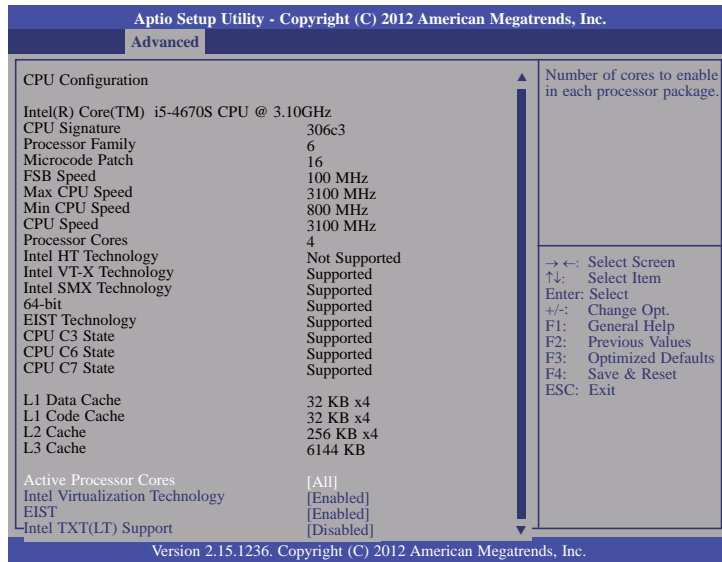

### Active Processor Cores

Number of cores to enable in each processor package.

### Intel Virtualization Technology

When this field is set to Enabled, the VMM can utilize the additional hardware capabilities provided by Vanderpool Technology.

### EIST

This field is used to enable or disable the Intel Enhanced SpeedStep Technology.

### Intel TXT(LT) Support

Enables or disables the support of the Intel Trusted Execution Technology.

## SATA Configuration

This section is used to configure settings of SATA devices.

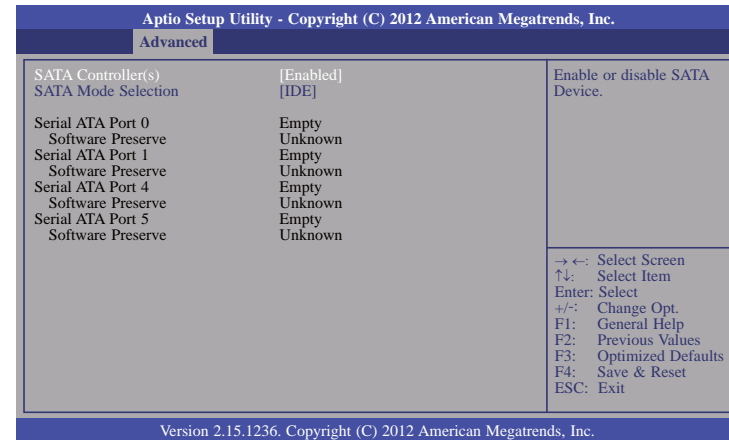

### SATA Controller(s)

This field is used to enable or disable the Serial ATA devices.

### SATA Mode Selection

The mode selection determines how the SATA controller(s) operates.

### IDE Mode

This option configures the Serial ATA drives as Parallel ATA storage devices.

### AHCI Mode

This option allows the Serial ATA devices to use AHCI (Advanced Host Controller Interface).

When IDE mode is selected in the SATA Mode Selection, it will display the following information:

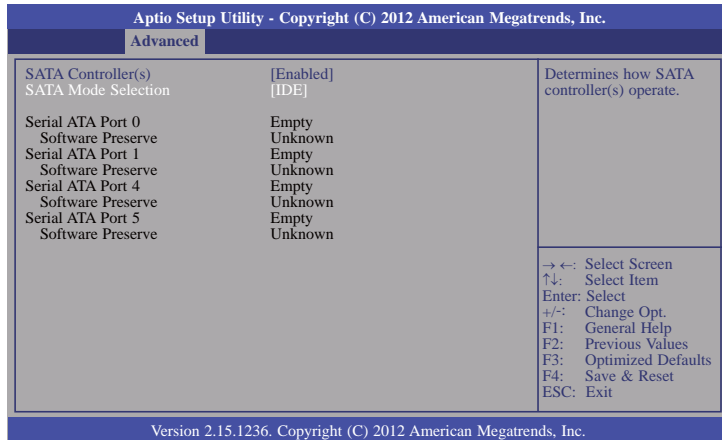

## SATA Controller Speed

Indicates the maximum speed that the SATA controller can support.

## Port 0, Port 1, Port 4 and Port 5

Enables or disables the SATA port.

## Hot Plug

Designates the SATA port as hot pluggable.

When AHCI mode is selected in the SATA Mode Selection, it will display the following information:

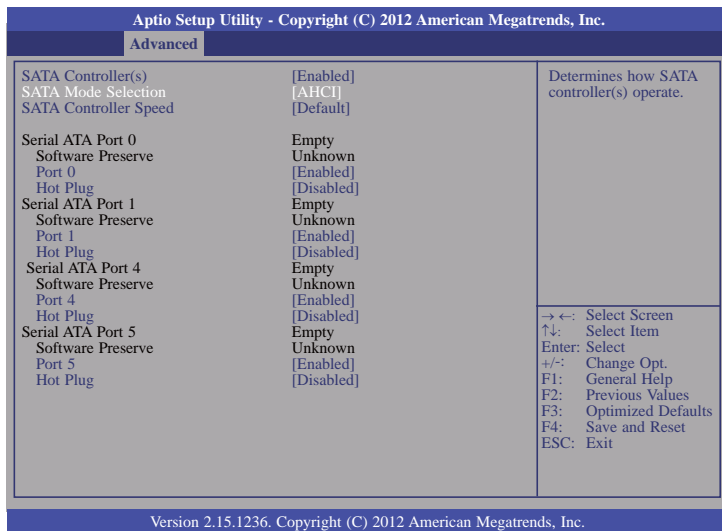

### PCH-FW Configuration

This section is used to configure the parameters of Management Engine Technology.

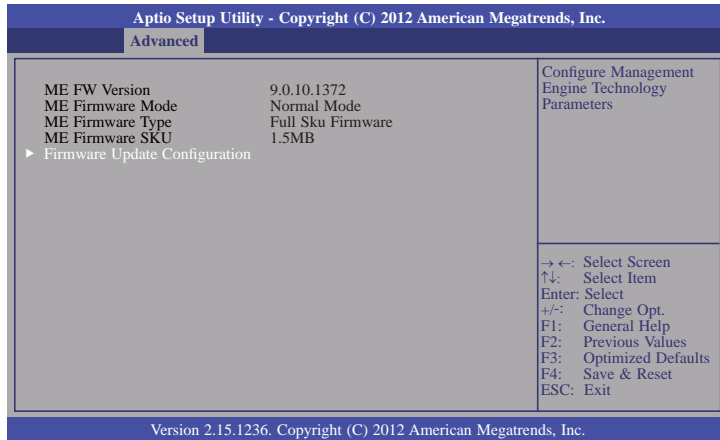

### Firmware Update Configuration

Enables or disables the Me FW Image Re-Flash function.

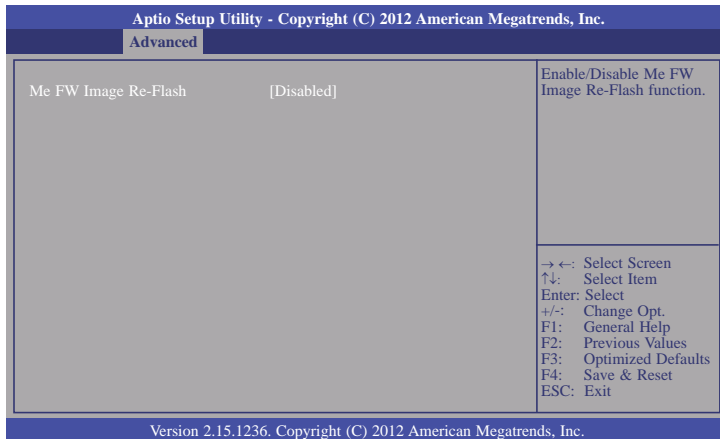

### USB Configuration

This section is used to configure the parameters of the USB device.

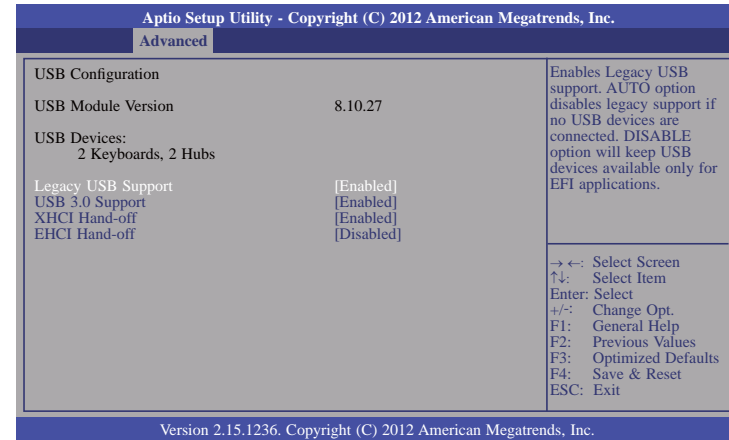

### Legacy USB Support

Enabled

Enables legacy USB.

Auto

Disables support for legacy when no USB devices are connected.

Disabled

Keeps USB devices available only for EFI applications.

### USB 3.0 Support

Enables or disables USB 3.0 (XHCI) Controller support.

### XHCI Hand-off

This is a workaround for OSeS without XHCI hand-off support. The XHCI ownership change should be claimed by XHCI driver.

### EHCI Hand-off

This is a workaround for OSeS that does not support EHCI hand-off. The EHCI ownership change should be claimed by the EHCI driver.



## Super IO Configuration

This section is used to configure the I/O functions supported by the onboard Super I/O chip.

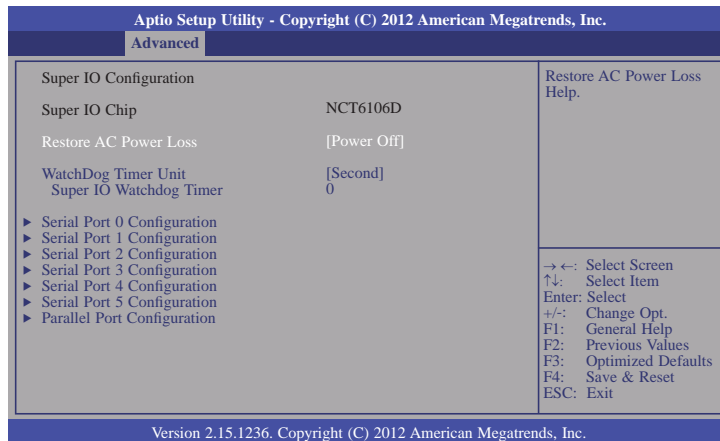

### Restore AC Power Loss

#### Power Off

When power returns after an AC power failure, the system's power is off. You must press the Power button to power-on the system.

#### Power On

When power returns after an AC power failure, the system will automatically power-on.

#### Last State

When power returns after an AC power failure, the system will return to the state where you left off before power failure occurs. If the system's power is off when AC power failure occurs, it will remain off when power returns. If the system's power is on when AC power failure occurs, the system will power-on when power returns.

### Watchdog Timer Unit

Selects the watchdog timer unit: second or minute.

### Super IO Watchdog Timer

Sets the timeout value of the super IO watchdog timer. 0 means disabled.

## Serial Port 0 Configuration to Serial Port 5 Configuration

Sets parameters of serial port 0 (COM A) to serial port 5 (COM F).

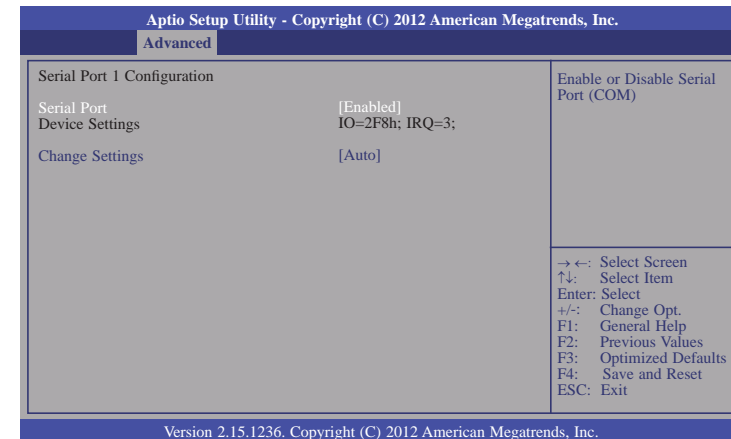
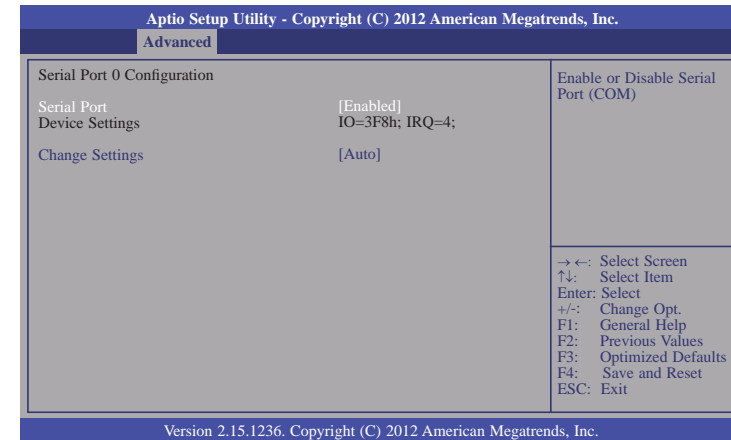

Aptio Setup Utility - Copyright (C) 2012 American Megatrends, Inc.		
Advanced		
Serial Port 2 Configuration		
Serial Port	[Enabled]	Enable or Disable Serial Port (COM)
Device Settings	IO=3E8h; IRQ=7;	
Change Settings	[Auto]	
		→ ←: Select Screen ↑ ↓: Select Item Enter: Select +/-: Change Opt. F1: General Help F2: Previous Values F3: Optimized Defaults F4: Save and Reset ESC: Exit
Version 2.15.1236. Copyright (C) 2012 American Megatrends, Inc.		

Aptio Setup Utility - Copyright (C) 2012 American Megatrends, Inc.		
Advanced		
Serial Port 4 Configuration		
Serial Port	[Enabled]	Enable or Disable Serial Port (COM)
Device Settings	IO=2E0h; IRQ=10;	
Change Settings	[Auto]	
		→ ←: Select Screen ↑ ↓: Select Item Enter: Select +/-: Change Opt. F1: General Help F2: Previous Values F3: Optimized Defaults F4: Save and Reset ESC: Exit
Version 2.15.1236. Copyright (C) 2012 American Megatrends, Inc.		

Aptio Setup Utility - Copyright (C) 2012 American Megatrends, Inc.		
Advanced		
Serial Port 3 Configuration		
Serial Port	[Enabled]	Enable or Disable Serial Port (COM)
Device Settings	IO=2E8h; IRQ=7;	
Change Settings	[Auto]	
		→ ←: Select Screen ↑ ↓: Select Item Enter: Select +/-: Change Opt. F1: General Help F2: Previous Values F3: Optimized Defaults F4: Save and Reset ESC: Exit
Version 2.15.1236. Copyright (C) 2012 American Megatrends, Inc.		

Aptio Setup Utility - Copyright (C) 2012 American Megatrends, Inc.		
Advanced		
Serial Port 5 Configuration		
Serial Port	[Enabled]	Enable or Disable Serial Port (COM)
Device Settings	IO=2F0h; IRQ=10;	
Change Settings	[Auto]	
		→ ←: Select Screen ↑ ↓: Select Item Enter: Select +/-: Change Opt. F1: General Help F2: Previous Values F3: Optimized Defaults F4: Save and Reset ESC: Exit
Version 2.15.1236. Copyright (C) 2012 American Megatrends, Inc.		

### Serial Port

Enables or disables these serial ports (COM).

### Change Settings

Selects the IO/IRQ settings for the super I/O device.

### Parallel Port Configuration

Sets parameters of Parallel port (LPT/LPE).

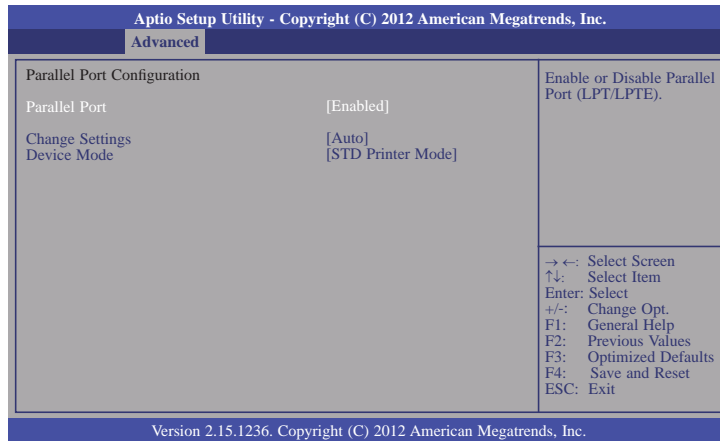

#### Parallel Port

Enables or disables the parallel port (LPT/LPTE).

#### Change Settings

Selects the IO setting for the super I/O device.

#### Device Mode.

Changes the mode for the printer port.

### PC Health Status

This section displays the hardware health monitor.

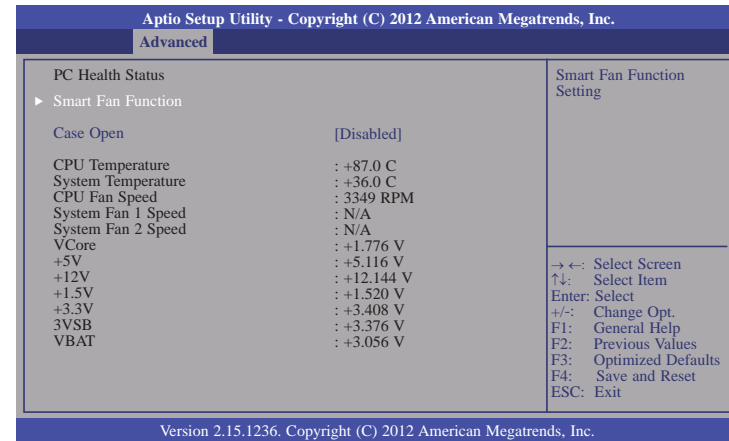

### Smart Fan Function

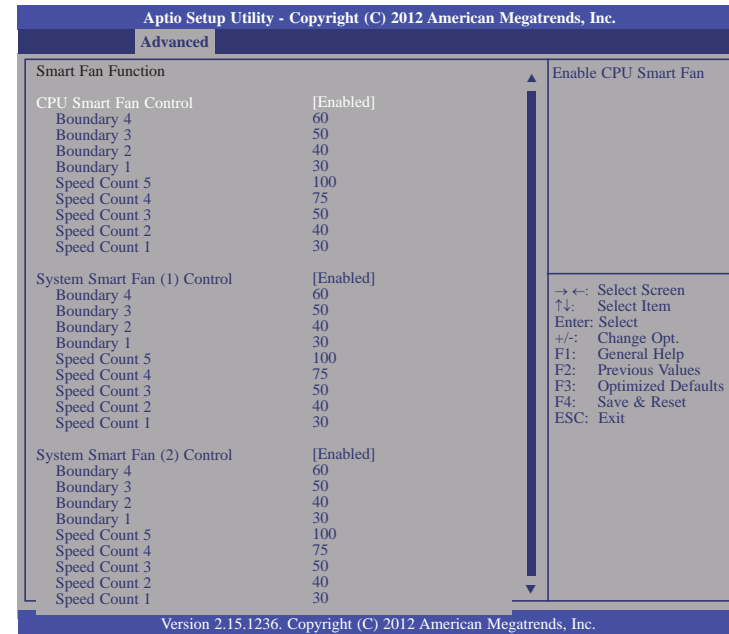

**CPU Smart Fan Control**

When this feature is set to Automatic, the CPU's fan speed will rotate according to the CPU's temperature. The higher the temperature, the faster the speed of rotation.

**System Smart Fan Control**

When this feature is set to Automatic, the System's fan speed will rotate according to the System's temperature. The higher the temperature, the faster the speed of rotation.

**Boundary 1 to Boundary 4**

The range is 0-127.

**Speed Count 1 to Speed Count 5**

The range is 1-100%.

**Case Open**

Sets this field to Enabled to allow the system to alert you of a chassis intrusion event.

**Second Super IO Configuration**

This section is used to set parameters for the system second super IO chip.

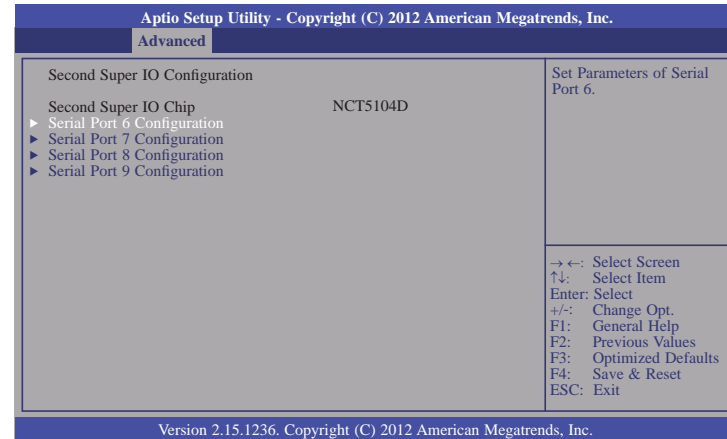

**Serial Port 6 Configuration to Serial Port 9 Configuration**

Sets parameters of serial port 6 to serial port 9.

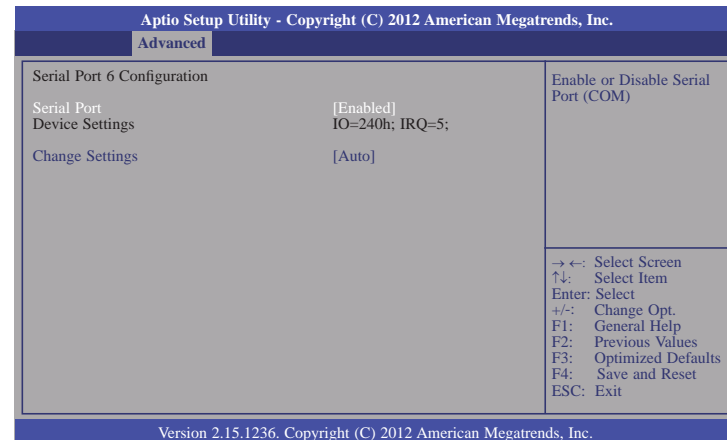

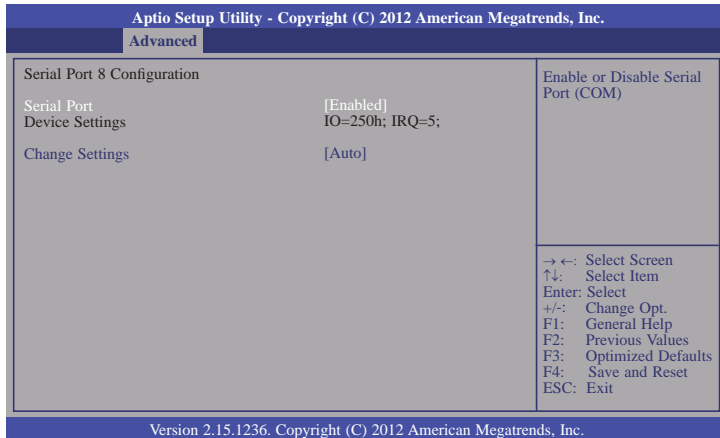
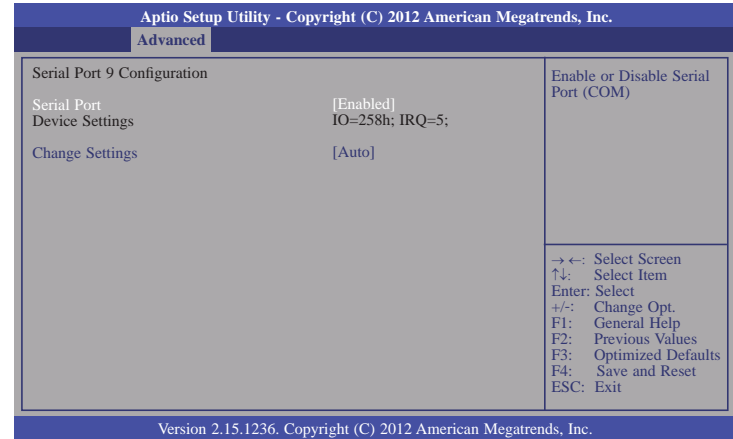
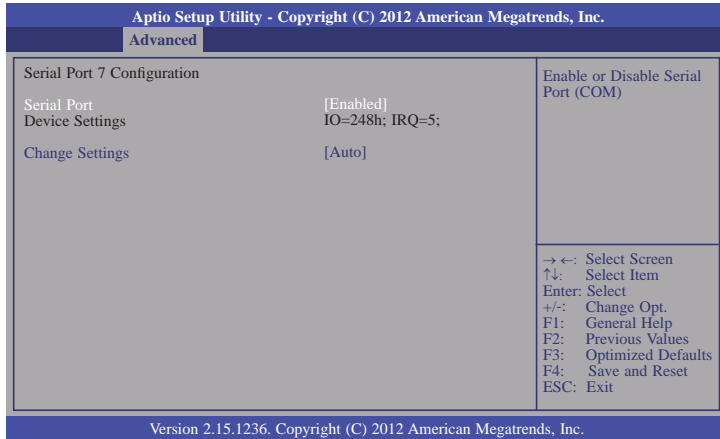

**Serial Port**

Enables or disables these serial ports (COM).

**Change Settings**

Selects the IO/IRQ settings for the super I/O device.

## Network Stack

This section is used to enable or disable UEFI network stack.

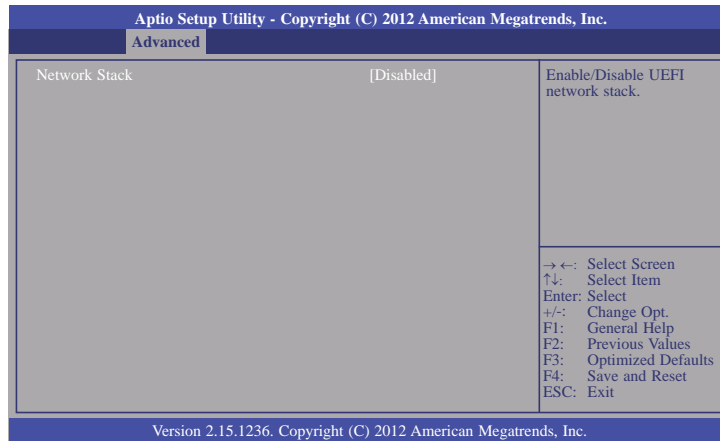

When Network Stack is enabled, it will display the following information:

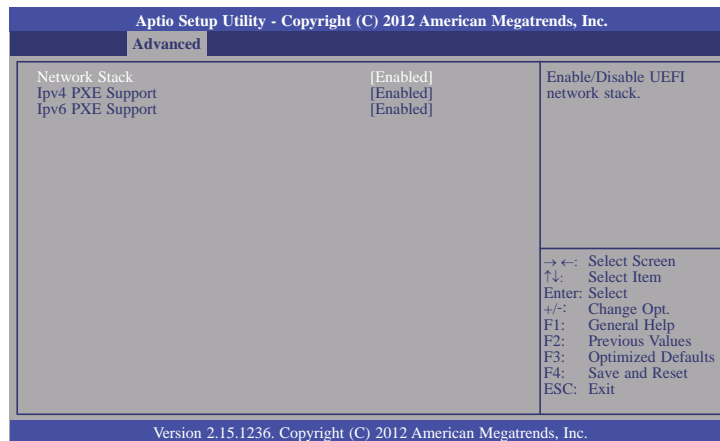

## Ipv4 PXE Support

When enabled, Ipv4 PXE boot supports. When disabled, Ipv4 PXE boot option will not be created.

## Ipv6 PXE Support

When enabled, Ipv6 PXE boot supports. When disabled, Ipv6 PXE boot option will not be created.

### Intel(R) I210 Gigabit Network Connection - 00:01:29:53:38:F6 (Only for reference)

This section is used to configure the parameters of the Gigabit Ethernet device.

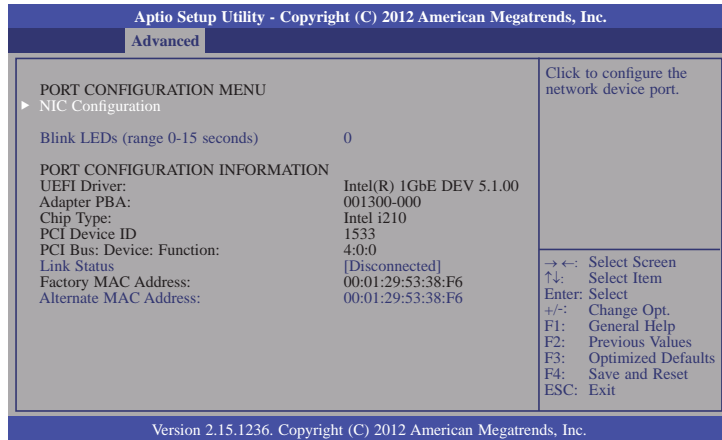

#### NIC Configuration

This field is used to configure the network device.

#### Blink LEDs

Blink LEDs for the specified duration (up to 15 seconds).

#### Link Status

This field indicates the link status of the network device.

#### Alternate MAC Address

Alternates assigned MAC address of Ethernet port.

## Chipset

This section configures relevant chipset functions.

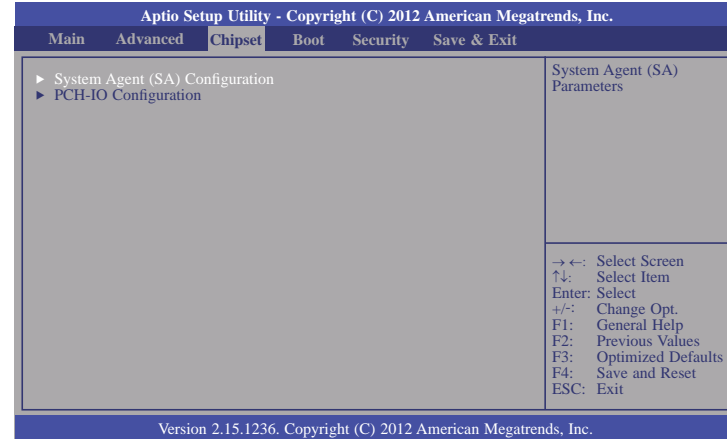

## System Agent (SA) Configuration

This section is used to configure the parameters of System Agent.

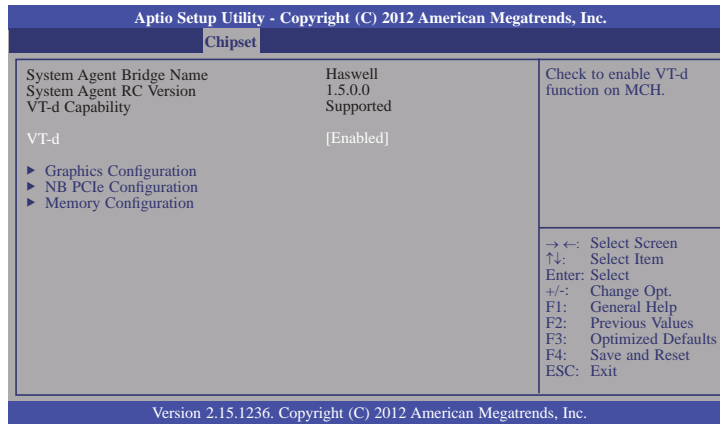

### VT-d

Checks to enable VT-d function on MCH.

## Graphics Configuration

This field configures the graphics settings.

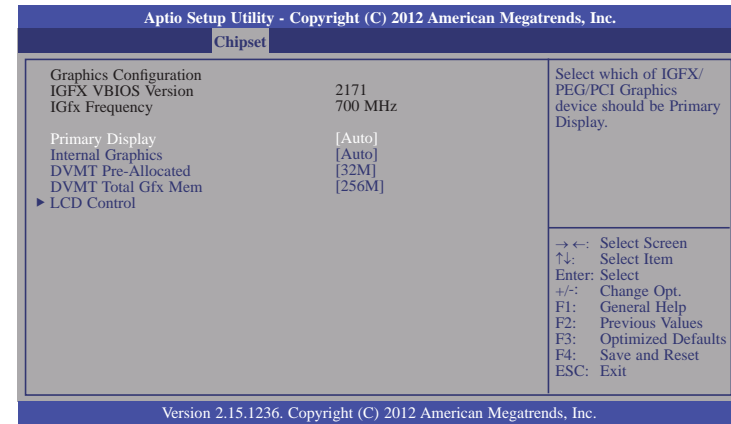

### Primary Display

**Auto** When the system boots, it will auto detects the display device.

**IGFX** When the system boots, it will first initialize the onboard VGA.

**PEG** When the system boots, it will first initialize the PCI Express x16 graphics card.

### Internal Graphics

Keeps IGD enabled based on the setup options.



### DVMT Pre-Allocated

Selects DVMT 5.0 Pre-Allocated (Fixed) Graphics Memory size used by the Internal Graphics Device. Please refer to the screen shown below.

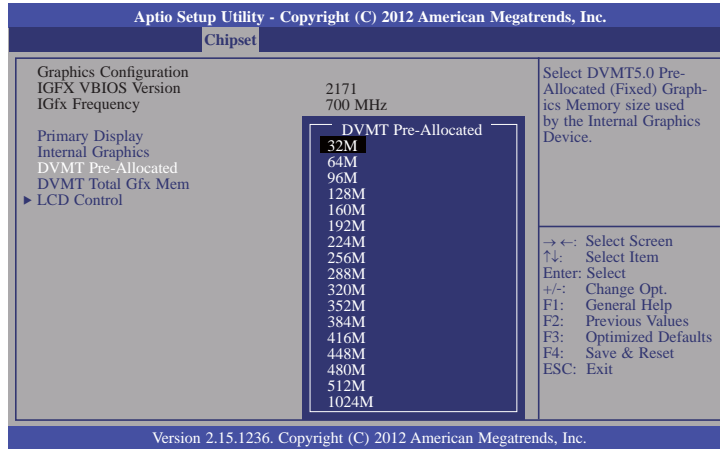

### DVMT Total Gfx Mem

Selects DVMT 5.0 total graphics memory size used by the internal graphics device. Please refer to the screen shown below.

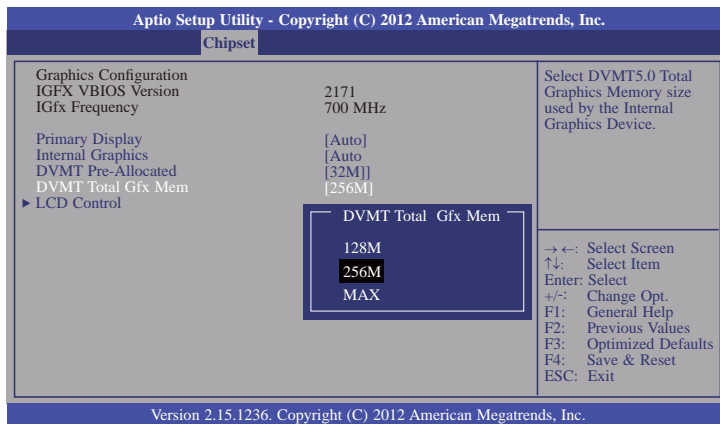

### LCD Control

This field configures the LCD control.

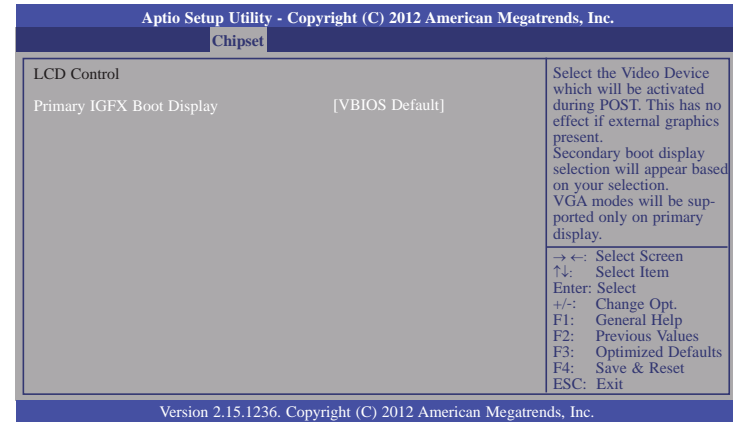

When any device is selected in the Primary IGFX Boot Display, it will display the following information:

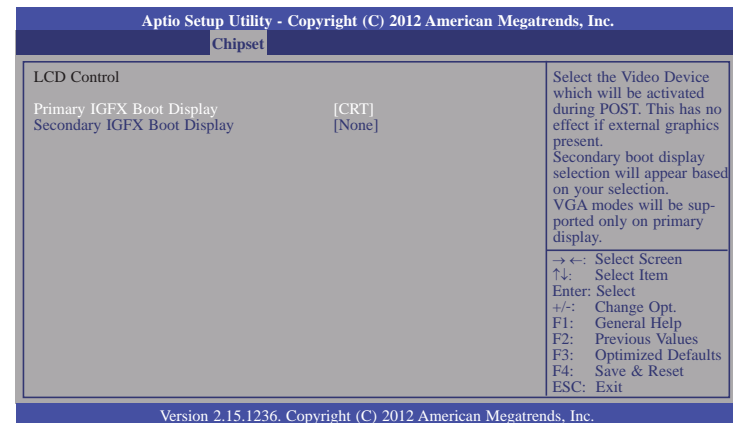

### Secondary IGFX Boot Display

Selects the secondary display device.

## NB PCIe Configuration

This field is used to configure the settings of NB PCI Express.

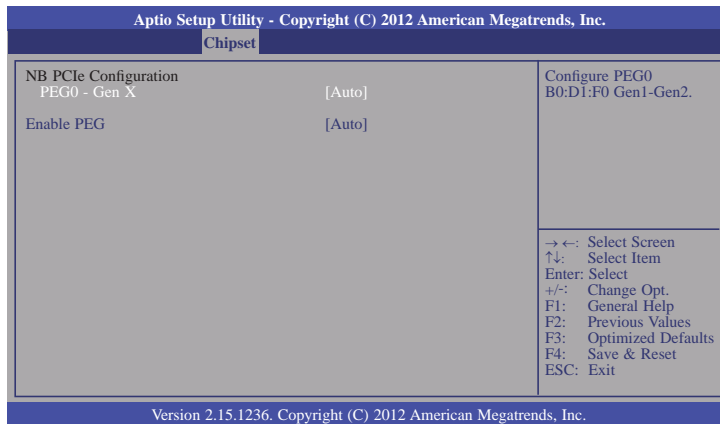

### Enable PEG

Enables or disables the PEG.

## Memory Configuration

This field only displays the memory configuration.

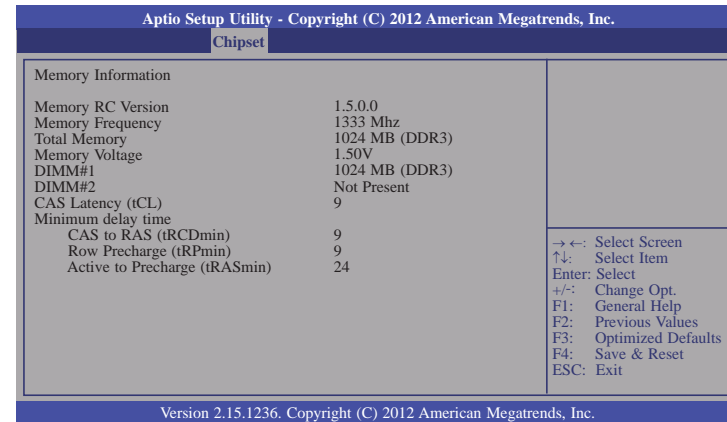

## PCH-IO Configuration

This section illustrates the PCH parameters.

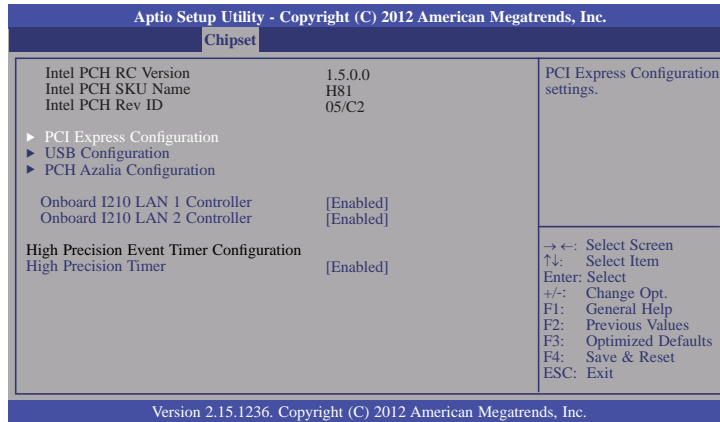

### Onboard I210 LAN 1/2 Controller

Enables or disables the onboard I210 LAN controller

### High Precision Timer

Enables or disables the High Precision Event Timer.

## PCI Express Configuration

This field is used to configure the PCI Express settings.

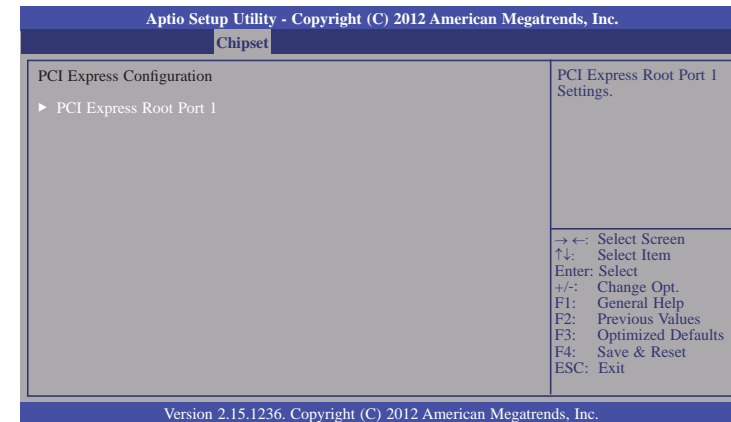

### PCI Express Root Port 1

Selects settings of the PCI Express Root Port 1.

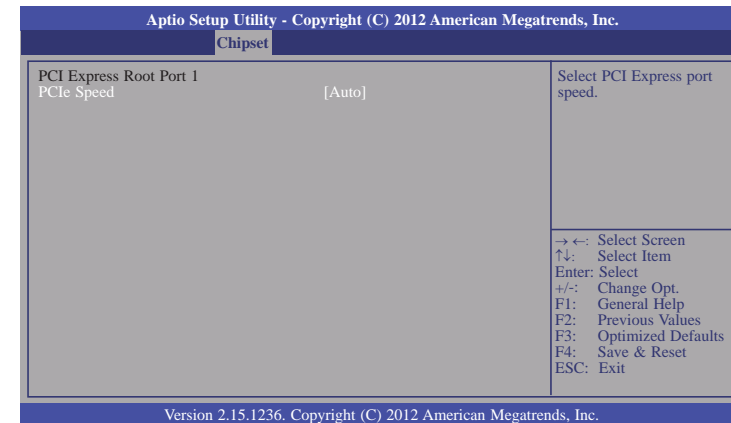

### PCIe Speed

Selects the speed of PCI Express port.

## USB Configuration

This field is used to configure the USB settings.

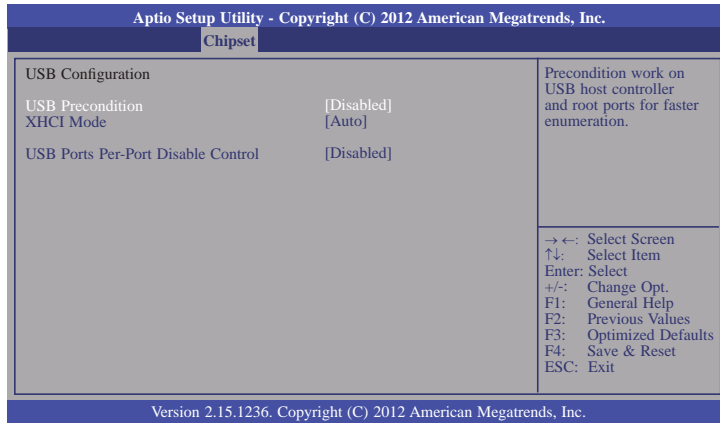

## USB Precondition

Precondition works on USB host controller and root ports for faster enumeration.

## XHCI Mode

Selects the operation mode of XHCI controller. These options are Auto, Enabled, and Disabled. When Disabled is selected in the XHCI Mode, it will display the following information:

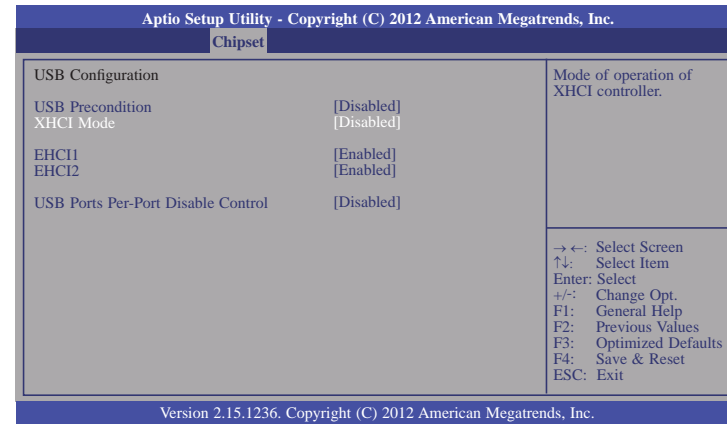

## EHCI 1 and EHCI 2

These fields are used to control the functions of USB EHCI (USB 2.0) controllers. One EHCI controller must always be enabled.

**USB Ports Per-Port Disable Control**

This field is used to control each of the USB ports (0~13) disabling. When enabled, it will display the following information:

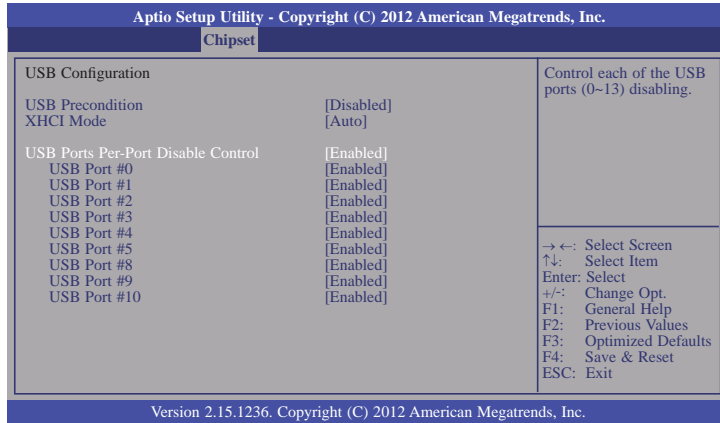

**USB Port #0/1/2/3/4/5/8/9/10**

Enables or disables these USB ports.

**PCH Azalia Configuration**

This field is used to configure the PCH Azalia settings.

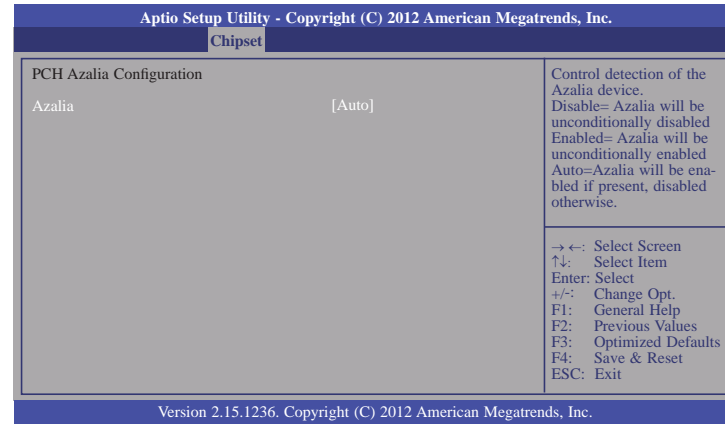

## Boot

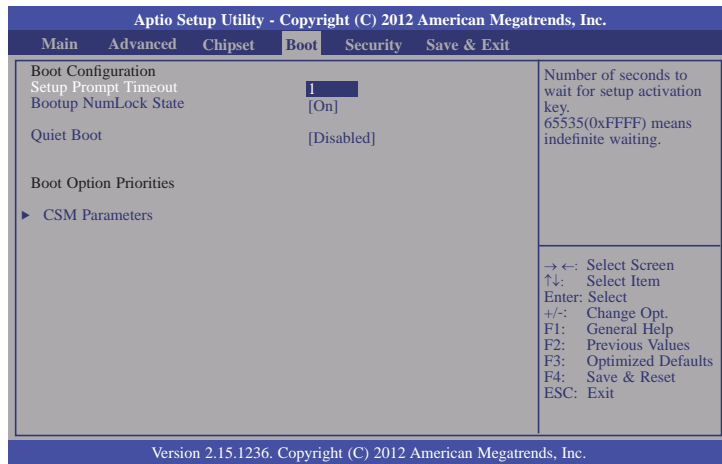

### Setup Prompt Timeout

Selects the number of seconds to wait for the setup activation key. 65535(0xFFFF) denotes indefinite waiting.

### Bootup NumLock State

This allows you to determine the default state of the numeric keypad. By default, the system boots up with NumLock on wherein the function of the numeric keypad is the number keys. When set to Off, the function of the numeric keypad is the arrow keys.

### Quiet Boot

Enables or disables the quiet boot function.

## CSM Parameters

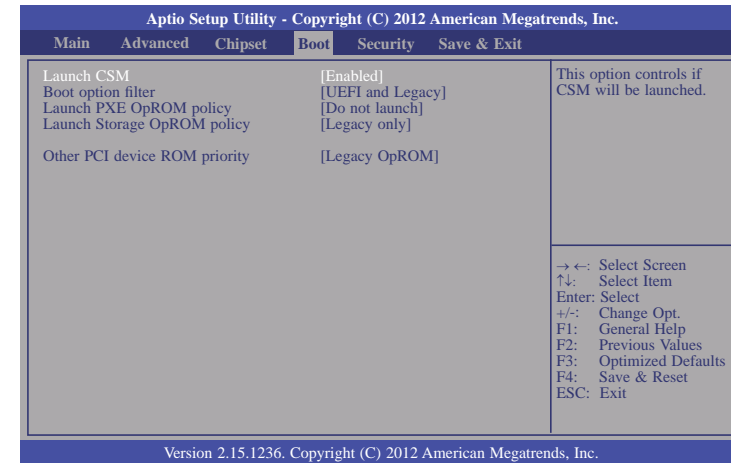

### Boot option filter

This option controls what devices system can be boot to.

### Launch PXE OpROM policy

Controls the execution of UEFI and legacy PXE OpROM.

### Launch Storage OpROM policy

Controls the execution of UEFI and legacy storage OpROM.

### Other PCI device ROM priority

For PCI devices other than Network, Mass Storage, or Video defines which OpROM to launch.

## Security

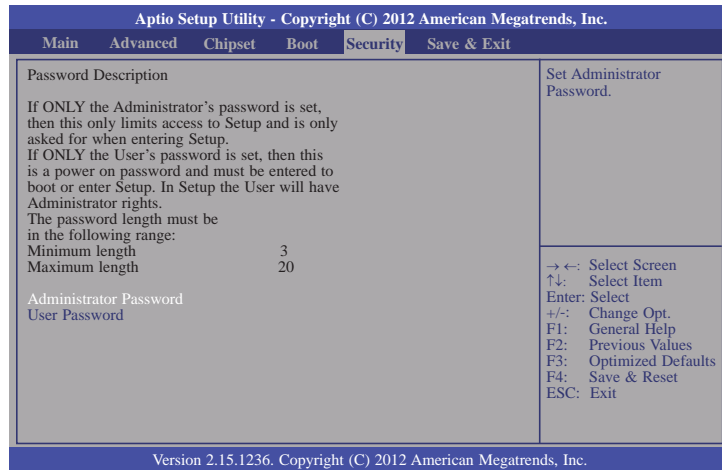

### Administrator Password

Sets the administrator password.

### User Password

Sets the user password.

## Save & Exit

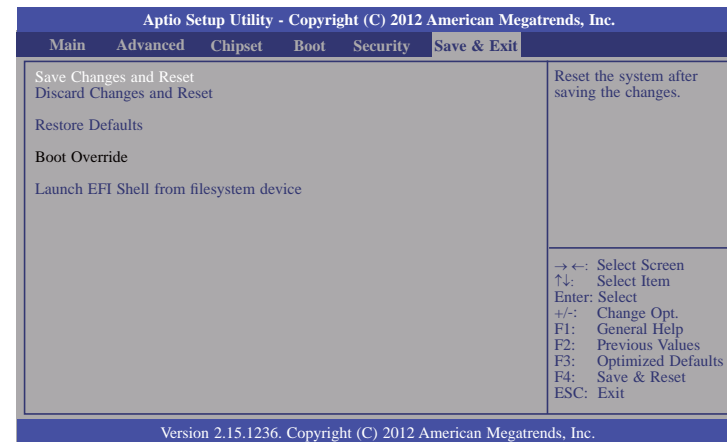

### Save Changes and Reset

To save the changes, select this field and then press <Enter>. A dialog box will appear. Select Yes to reset the system after saving all changes made.

### Discard Changes and Reset

To discard the changes, select this field and then press <Enter>. A dialog box will appear. Select Yes to reset the system setup without saving any changes.

### Restore Defaults

To restore and load the optimized default values, select this field and then press <Enter>. A dialog box will appear. Select Yes to restore the default values of all the setup options.

### Launch EFI Shell from filesystem device

Attempts to Launch EFI Shell application (Shellx64.efi) from one of the available filesystem devices.

## Updating the BIOS

To update the BIOS, you will need the new BIOS file and a flash utility, AFUDOS.EXE. Please contact technical support or your sales representative for the files.

To execute the utility, type:

```
A:> AFUDOS BIOS_File_Name /b /p /n
```

then press <Enter>.

```
C:\AFU\AFUDOS>afudos filename /B /P /N
+-----+
|              AMI Firmware Update Utility(APTIO) v2.25              |
|              Copyright (C)2008 American Megatrends Inc. All Rights Reserved.              |
+-----+
Reading file ..... done
Erasing flash ..... done
Writing flash ..... done
Verifying flash ..... done
Erasing BootBlock ..... done
Writing BootBlock ..... done
Verifying BootBlock ..... done
C:\AFU\AFUDOS>
```

## Notice: BIOS SPI ROM

1. The Intel® Management Engine has already been integrated into this system board. Due to the safety concerns, the BIOS (SPI ROM) chip cannot be removed from this system board and used on another system board of the same model.
2. The BIOS (SPI ROM) on this system board must be the original equipment from the factory and cannot be used to replace one which has been utilized on other system boards.
3. If you do not follow the methods above, the Intel® Management Engine will not be updated and will cease to be effective.



### Note:

- a. You can take advantage of flash tools to update the default configuration of the BIOS (SPI ROM) to the latest version anytime.
- b. When the BIOS IC needs to be replaced, you have to populate it properly onto the system board after the EEPROM programmer has been burned and follow the technical person's instructions to confirm that the MAC address should be burned or not.



## Chapter 4 - Supported Software

Install drivers, utilities and software applications that are required to facilitate and enhance the performance of the system board. You may acquire the software from your sales representatives, from an optional DVD included in the shipment, or from the website download page at <https://www.dfi.com/DownloadCenter>.

### For Windows 8

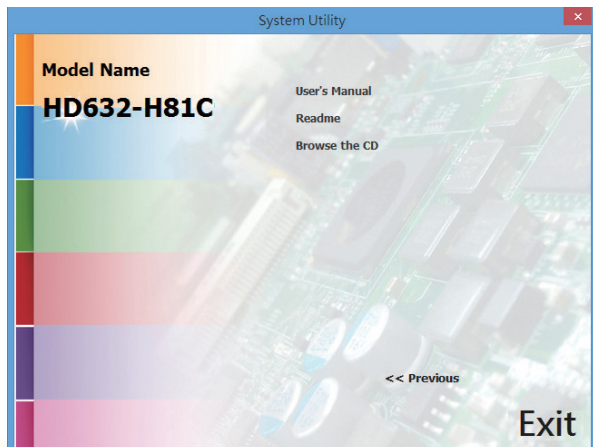
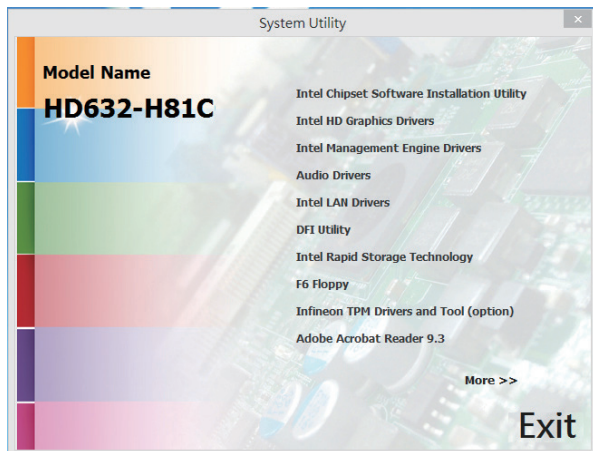

### For Windows 7



**Note:**

This step can be ignored if the applications are standalone files.

## For Windows XP



## Microsoft .NET Framework 3.5 (For Windows XP)

**Note:**

Before installing Microsoft .NET Framework 3.5, make sure you have updated your Windows XP operating system to Service Pack 3.

To install the driver, click "Microsoft .NET Framework 3.5" on the main menu.

1. Read the license agreement carefully.

Click "I have read and accept the terms of the License Agreement" then click Install.

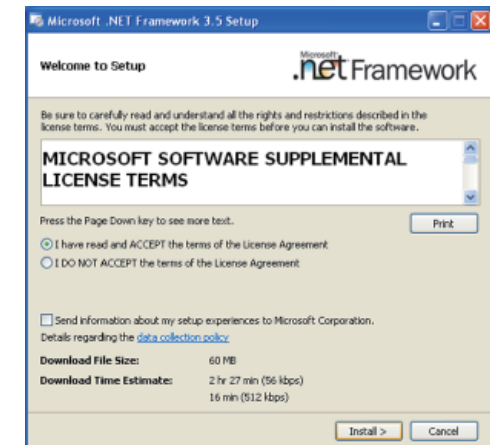

2. Setup is now installing the driver.

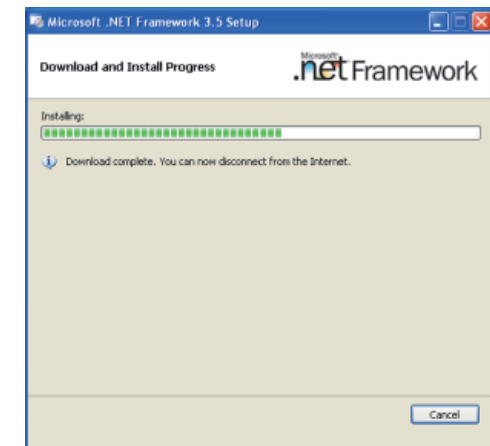

3. Click Exit.

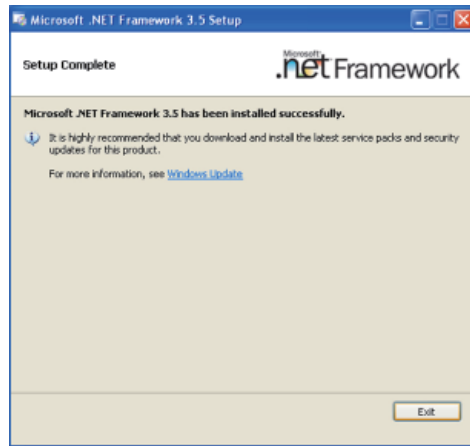

## Intel Chipset Software Installation Utility

The Intel Chipset Software Installation Utility is used for updating Windows® INF files so that the Intel chipset can be recognized and configured properly in the system.

To install the utility, click “Intel Chipset Software Installation Utility” on the main menu.

1. Setup is ready to install the utility. Click Next.



2. Read the license agreement then click Yes.



- Go through the readme document for more installation tips then click Next.

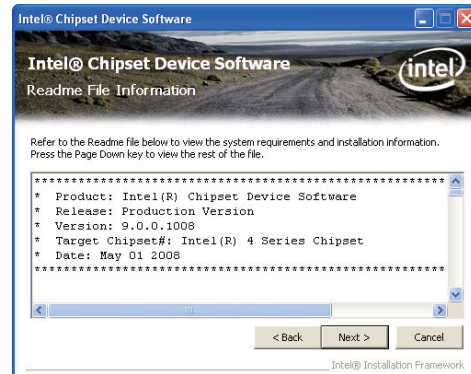

- Click Finish to exit setup.



## Microsoft DirectX 9.0C (For Windows XP)

To install the utility, click “Microsoft DirectX 9.0C Driver” on the main menu.

- Click “I accept the agreement” then click Next.



- To start installation, click Next.

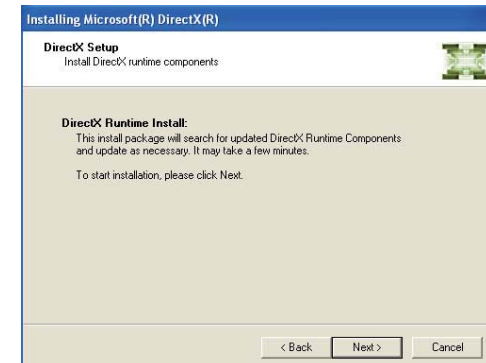

- Click Finish. Reboot the system for DirectX to take effect.

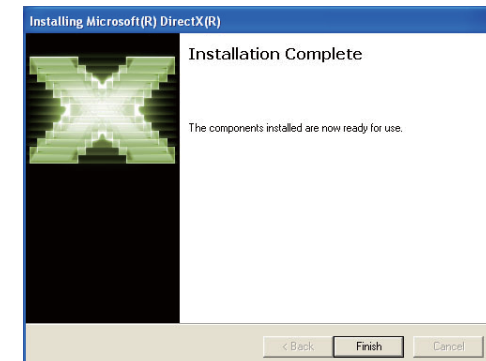

## Intel HD Graphics Drivers (For Windows XP)

To install the driver, click “Intel HD Graphics Drivers” on the main menu.

1. To start installation, click Next.



2. Read the license agreement then click Yes.

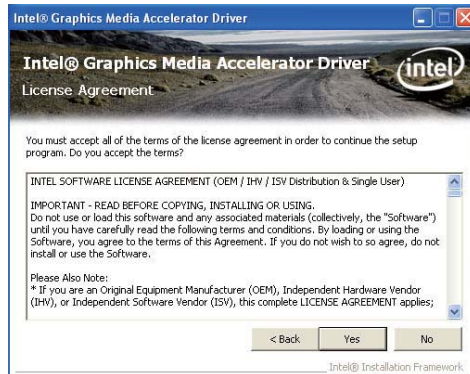

3. Go through the readme document for system requirements and installation tips then click Next.

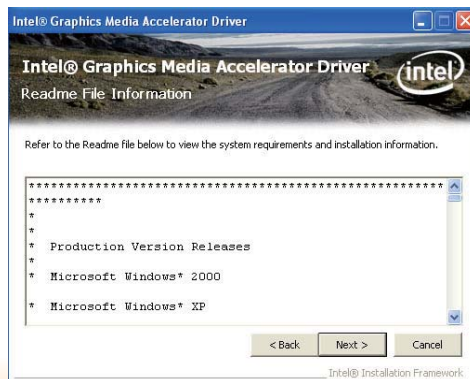

4. Setup is now installing the driver. Click Next to continue.

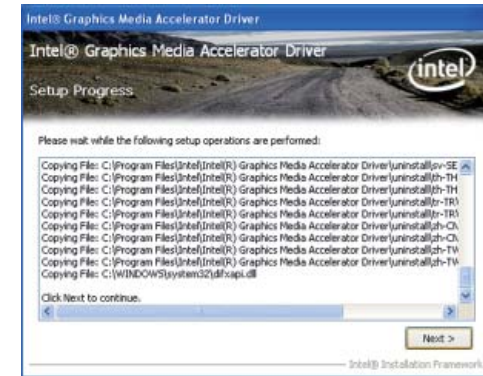

5. Click “Yes, I want to restart this computer now” then click Finish.

Restarting the system will allow the new software installation to take effect.

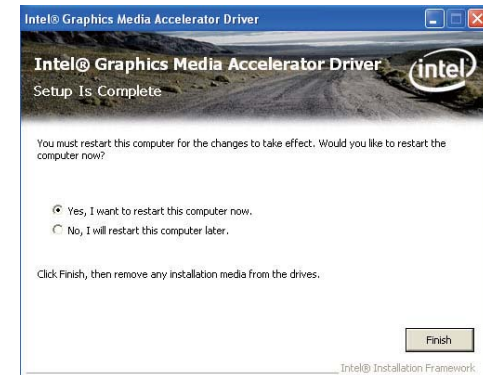



## Intel Graphics Drivers (For Windows 7 and Windows 8)

To install the driver, click “Intel Graphics Drivers” on the main menu.

1. Setup is now ready to install the graphics driver. Click Next.



By default, the “Automatically run WinSAT and enable the Windows Aero desktop theme” is enabled. With this enabled, after installing the graphics driver and the system rebooted, the screen will turn blank for 1 to 2 minutes (while WinSAT is running) before the Windows Vista desktop appears. The “blank screen” period is the time Windows is testing the graphics performance.

2. Read the license agreement then click Yes.

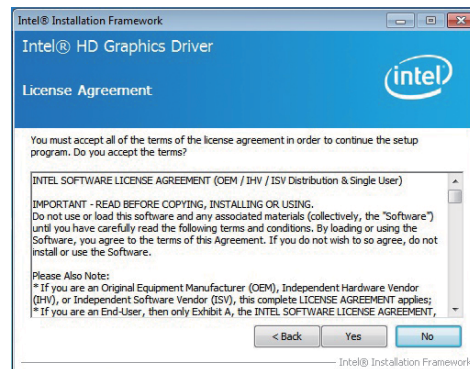

3. Go through the readme document for system requirements and installation tips then click Next.

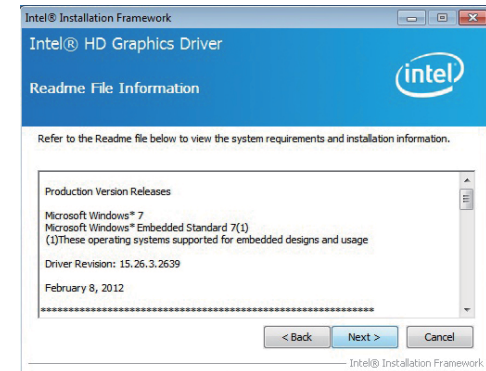

4. Setup is now installing the driver. Click Next to continue.

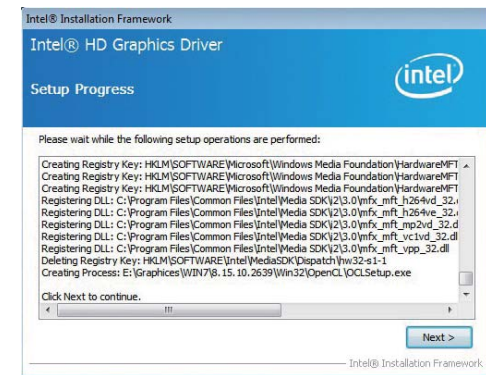

5. Click “Yes, I want to restart this computer now” then click Finish.

Restarting the system will allow the new software installation to take effect.



## Intel Management Engine Drivers

To install the driver, click "Intel Management Engine Drivers" on the main menu.

1. Setup is ready to install the driver. Click Next.



2. Read the license agreement then click Yes.

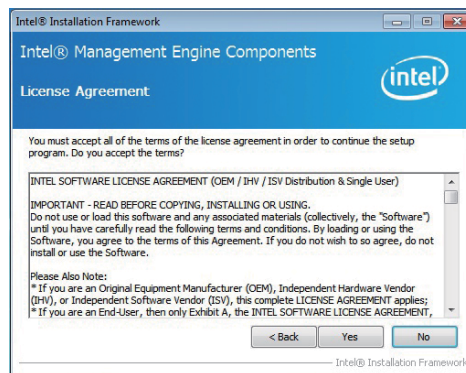

3. Setup is currently installing the driver. After installation has completed, click Next.

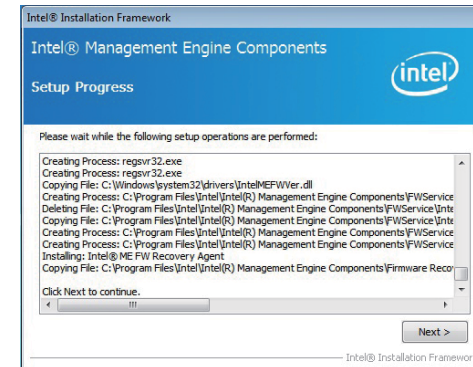

4. After completing installation, click Finish.

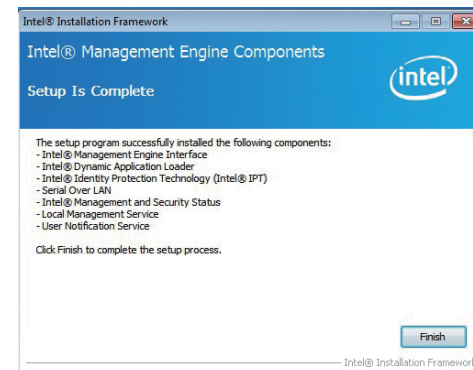

## Audio Drivers

To install the driver, click "Audio Drivers" on the main menu.

1. Setup is ready to install the driver. Click Next.

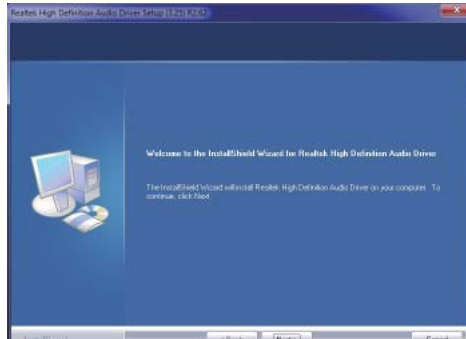

2. Click "Yes, I want to restart my computer now" then click Finish.

Restarting the system will allow the new software installation to take effect.

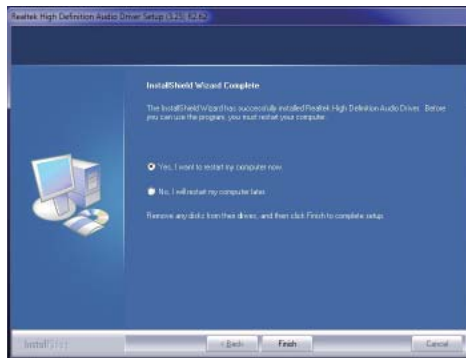

## Intel LAN Drivers (For Windows XP)

The LAN driver for Windows XP supporting on the HD632-H81 system boards has to be installed manually. When you want to install the LAN driver for Windows XP, please follow the steps below to accomplish the installation.

1. Launch the Hardware Update Wizard for the selected device. Select "Update Driver."

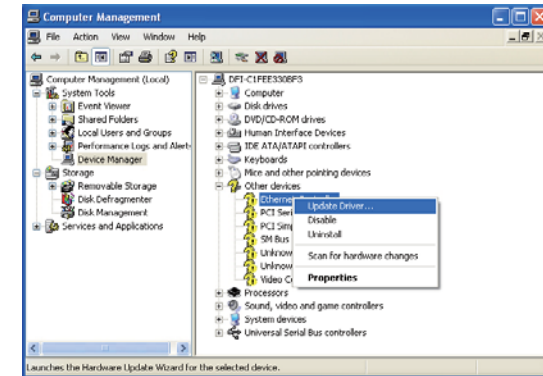

2. Choose "Install from a list or specific location (Advanced)" and click "Next" to continue the installation.

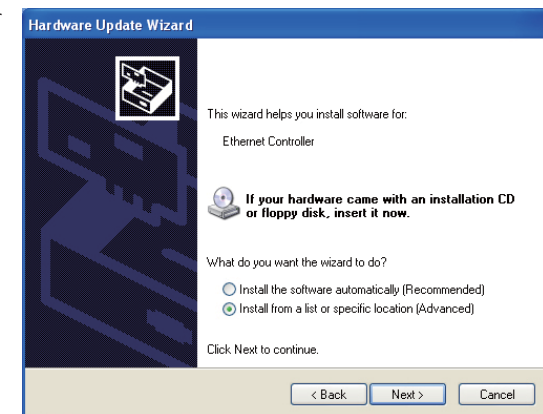



3. Choose the option "Don't search. I will choose the driver to install" in order to select the device driver from a list, and click "Next."

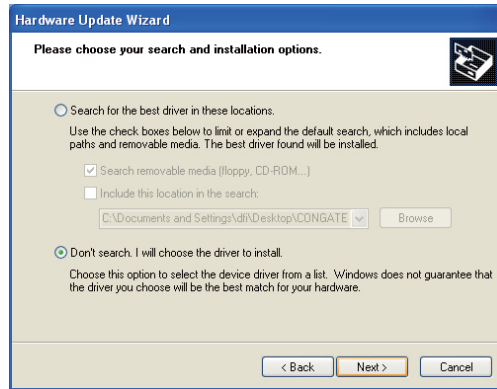

4. Select a hardware type: DVD/CD-ROM drives. Then, click "Next."

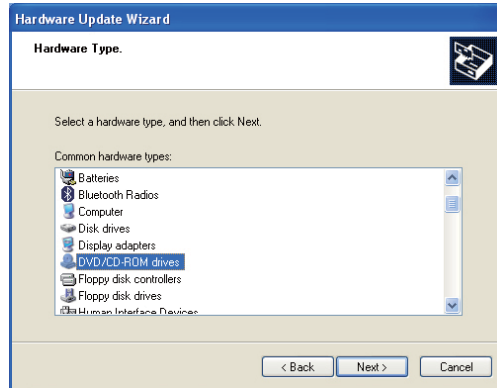

5. Select your hardware disk and then click "Have Disk..."

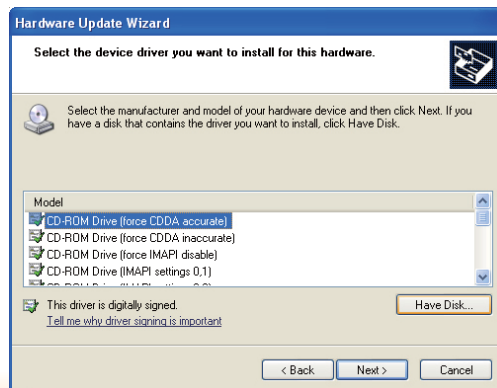

6. Insert the installation disk and make sure the selected drive is correct.

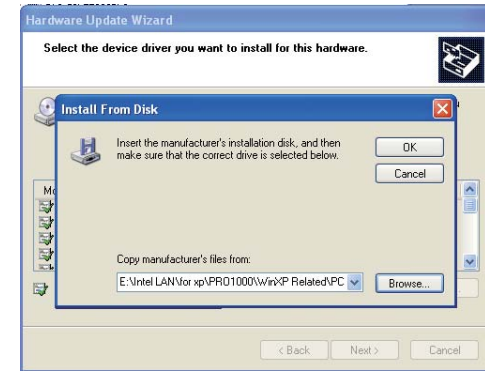

(For 32-bit, the file name is "e1d5132.inf".)

7. Select the device driver you want to install for this hardware and then click "Next."

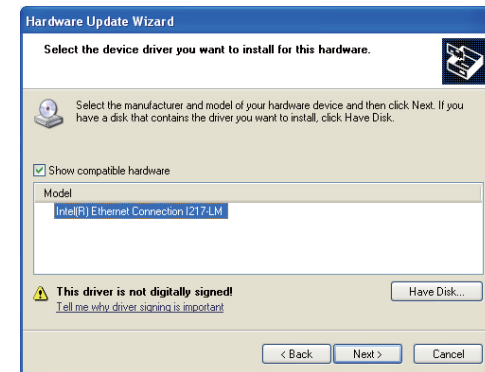

8. Check the software you are installing, Then, click "Continue Anyway" to start the installation.

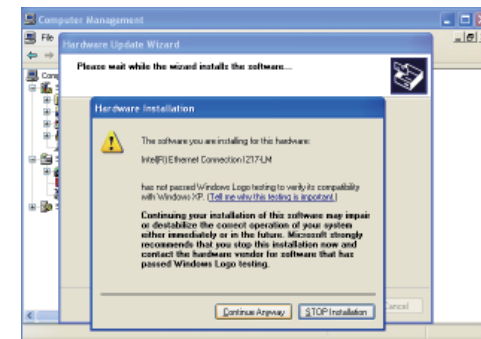

9. Click "Finish" to close the wizard.

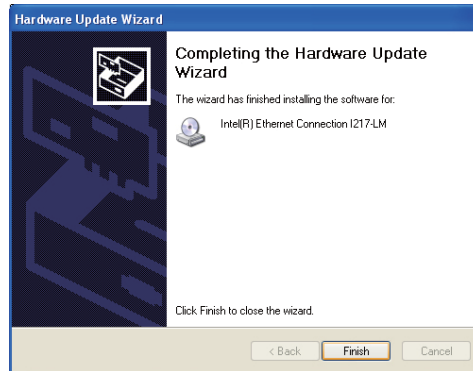

10. After completing the installation, the Network adapters "Intel(R) Ethernet Connection I217LM" will appear on the computer management list.

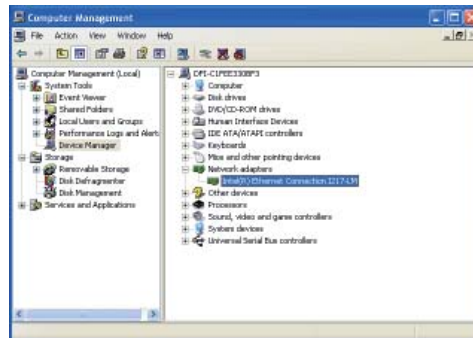

## Intel LAN Drivers (For Windows 7 and Windows 8)

To install the driver, click "Intel LAN Drivers" on the main menu.

1. Setup is ready to install the driver. Click Next.



2. Click "I accept the terms in the license agreement" then click "Next".

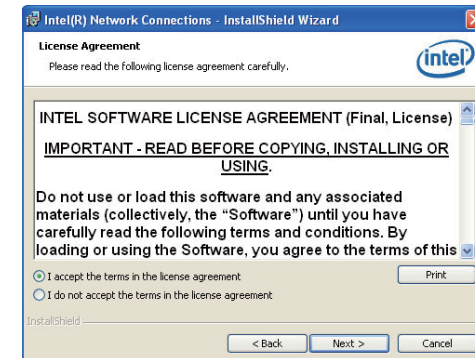

3. Select the program features you want installed then click Next.

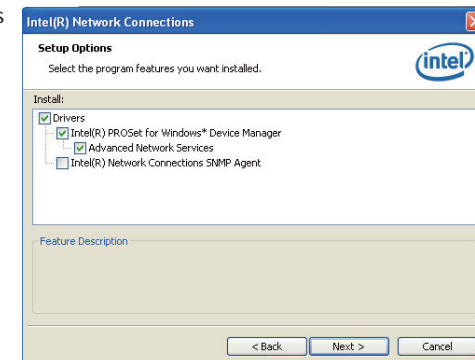

4. Click Install to begin the installation.

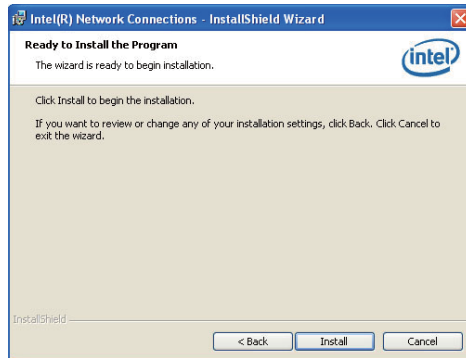

5. After completing installation, click Finish.

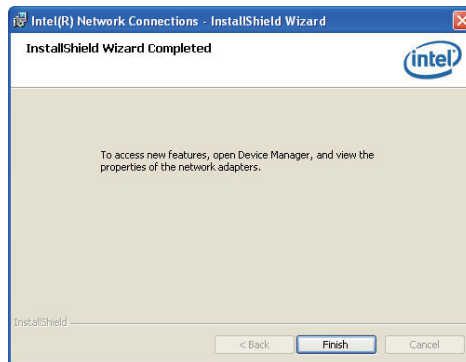

## DFI Utility

DFI Utility provides information about the board, Watchdog, and DIO. To access the utility, click "DFI Utility" on the main menu.



### Note:

If you are using Windows 7, you need to access the operating system as an administrator to be able to install the utility.

1. Setup is ready to install the DFI Utility driver. Click "Next".



2. Click "I accept the terms in the license agreement" then click "Next".

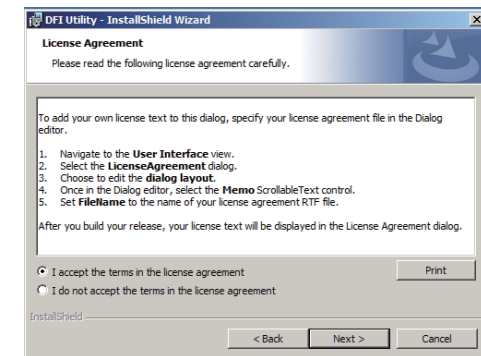

3. Click "Install" to begin the installation.

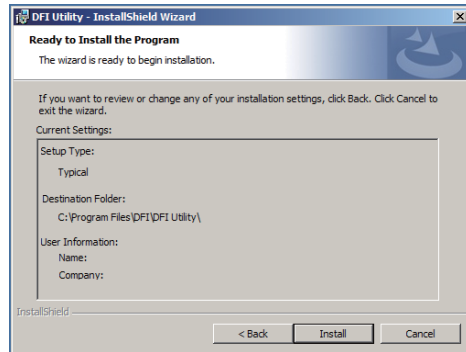

4. After completing installation, click "Finish".

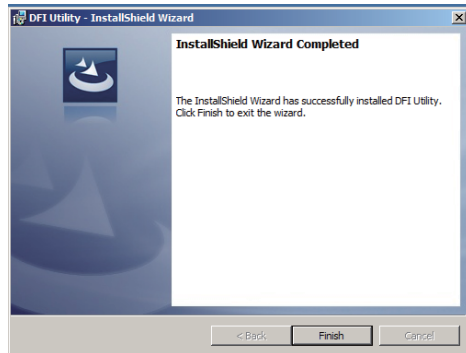

The DFI Utility icon will appear on the desktop. Double-click the icon to open the utility.

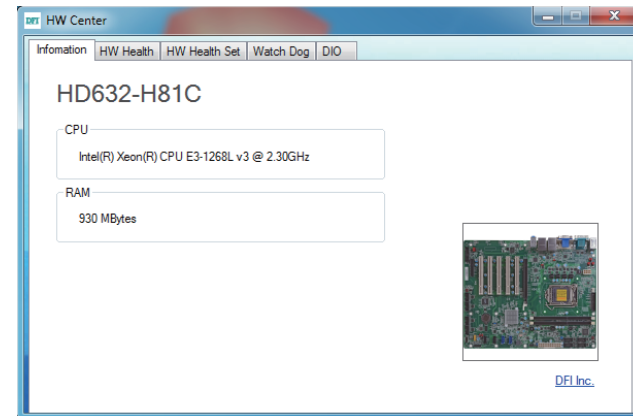

Information

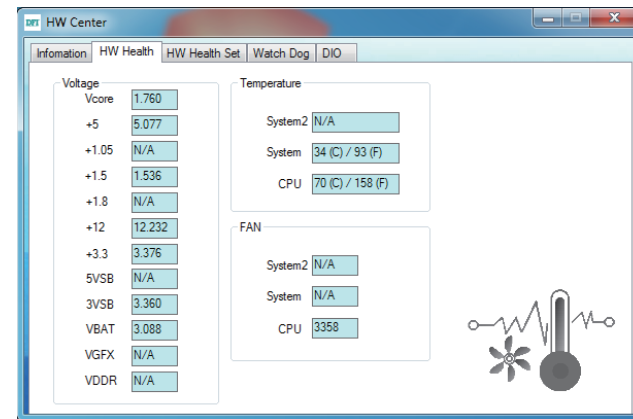

HW Health

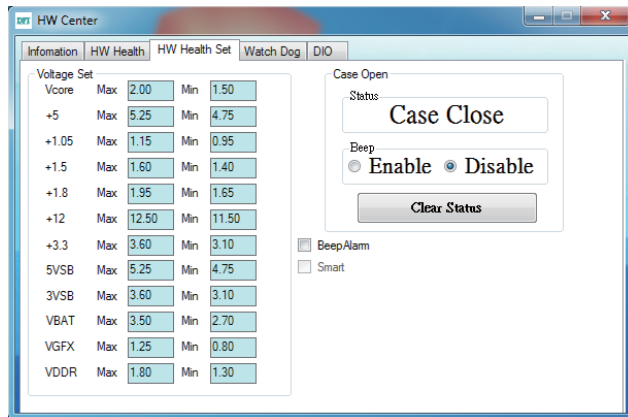

HW Health Set

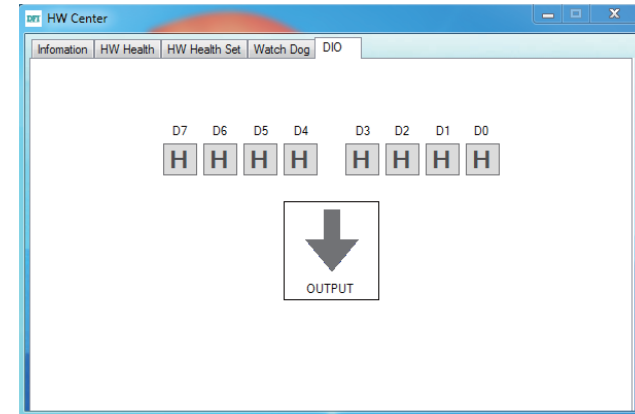

DIO

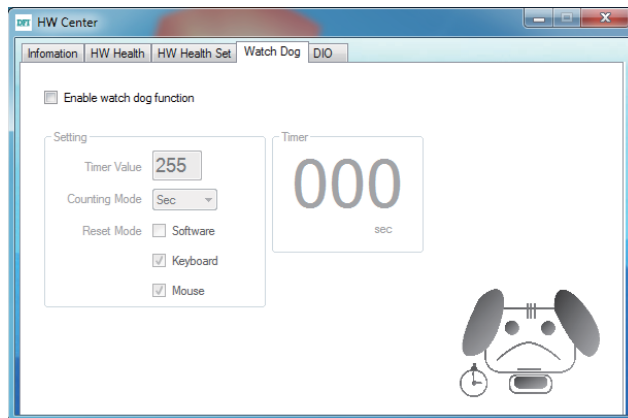

WatchDog

## Intel USB 3.0 Drivers (For Windows 7)

To install the driver, click "Intel USB 3.0 Driver" on the main menu.

1. Setup is ready to install the driver. Click Next.

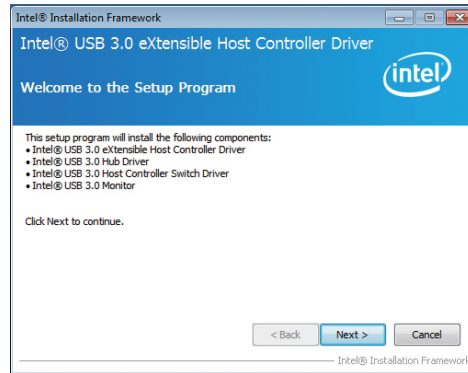

2. Read the license agreement then click Yes.

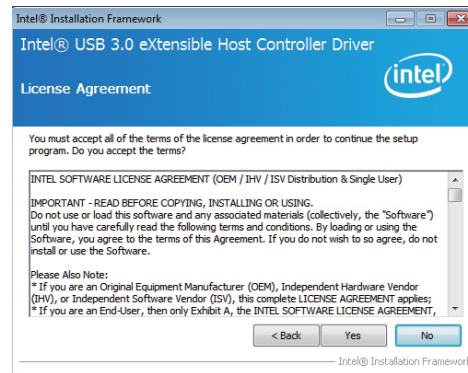

3. Go through the readme document for more installation tips then click Next.

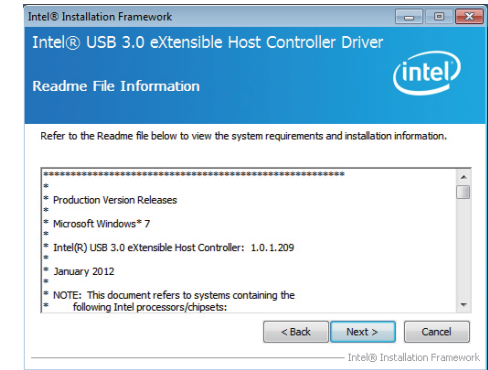

4. Setup is currently installing the driver. After installation has completed, click Next.

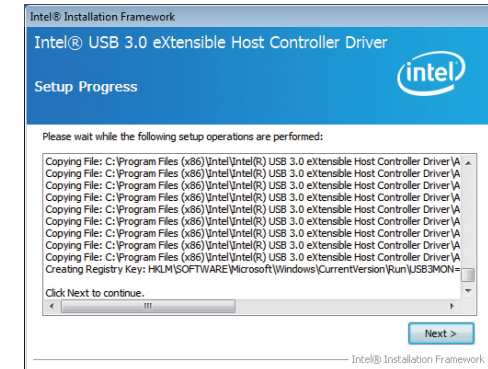

5. After completing installation, click Finish.



## Intel Rapid Storage Technology (For Windows 7 and Windows 8)

The Intel Rapid Storage Technology is a utility that allows you to monitor the current status of the SATA drives. It enables enhanced performance and power management for the storage subsystem.

To install the driver, click "Intel Rapid Storage Technology" on the main menu.

1. Setup is now ready to install the utility. Click Next.

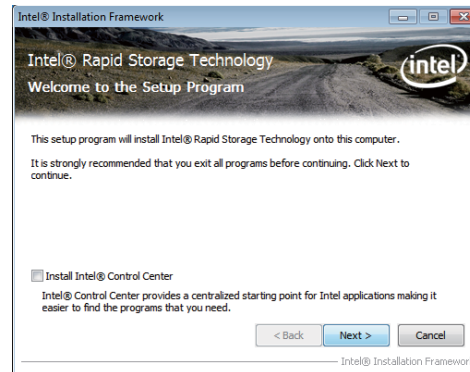

2. Read the warning then click Yes.

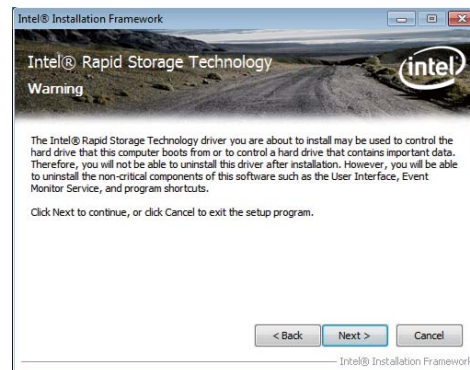

3. Read the license agreement then click Yes.

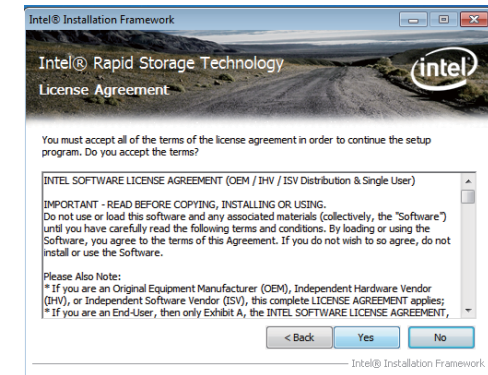

4. Go through the readme document for system requirements and installation tips then click Next.

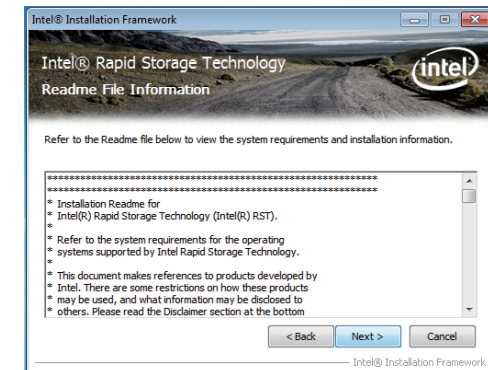

5. Setup is now installing the utility. Click Next to continue.

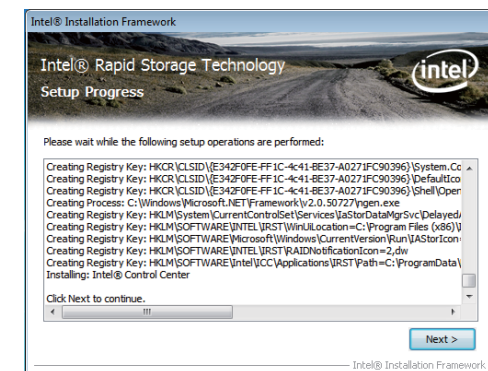



6. Click “Yes, I want to restart my computer now” then click Finish.

Restarting the system will allow the new software installation to take effect.



## Infinion TPM Driver and Tool (optional)

To install the driver, click “Infinion TPM driver and tool (option)” on the main menu.

1. The setup program is preparing to install the driver.

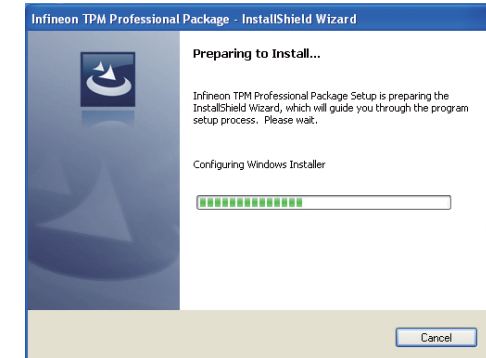

2. The setup program is now ready to install the utility. Click Next.

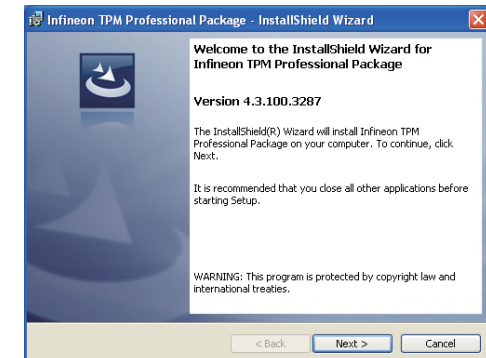

3. Click “I accept the terms in the license agreement” and then click “Next”.

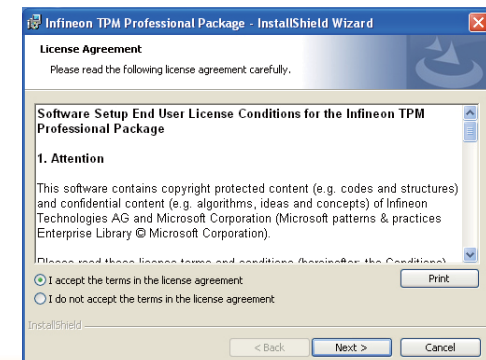



4. Enter the necessary information and then click Next.

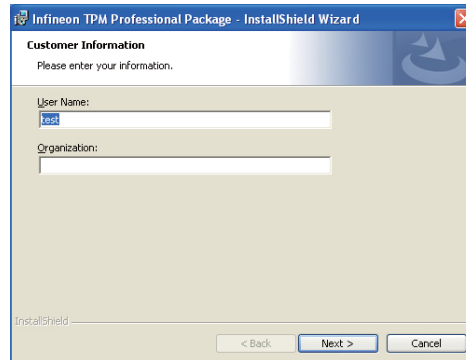

5. Select a setup type and then click Next.

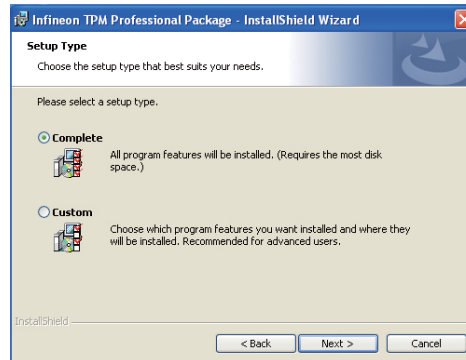

6. Click Install.

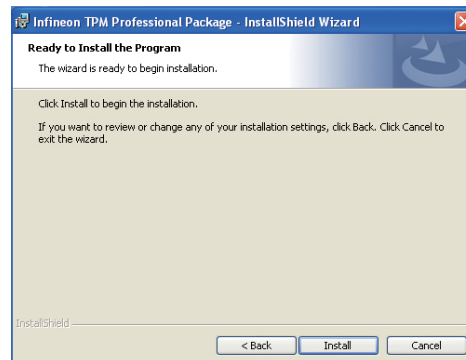

7. TPM requires installing the Microsoft Visual C++ package prior to installing the utility. Click Install.

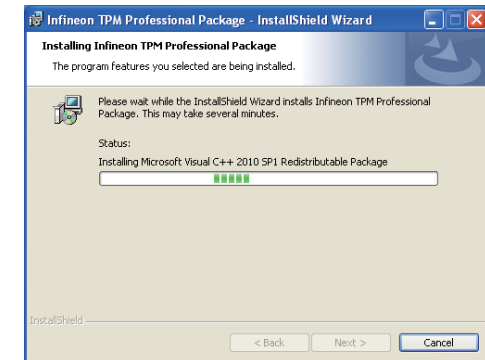

8. The setup program is currently installing the Microsoft Visual C++ package.

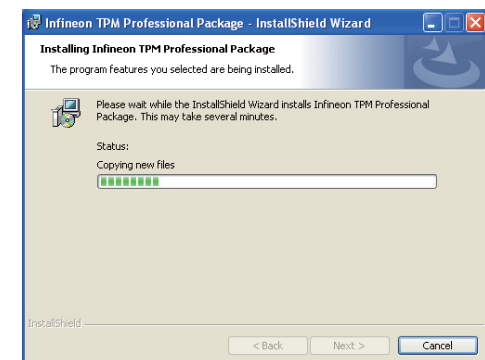

9. Click Finish.



10. Click “Yes” to restart your system.

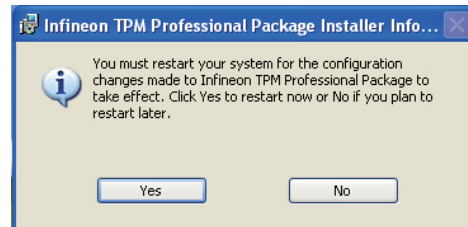

## Adobe Acrobat Reader 9.3

To install the reader, click “Adobe Acrobat Reader 9.3” on the main menu.

1. Click Next to install or click Change Destination Folder to select another folder.

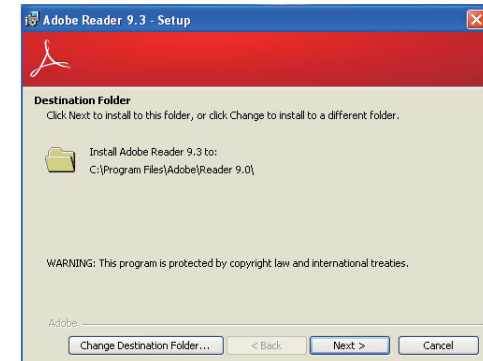

2. Click Install to begin installation.

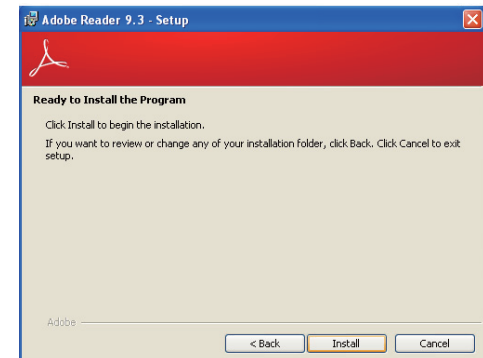

3. Click Finish to exit installation.

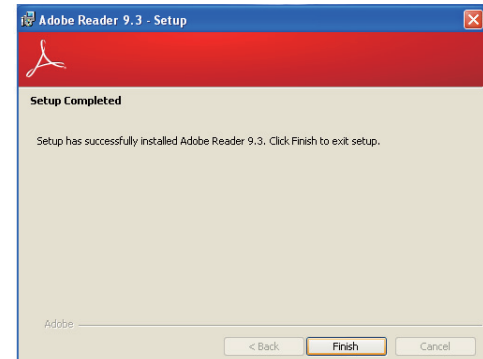

## Chapter 5 - Digital I/O Programming Guide

### Register Description

The Input Port Register (register 0) reflects the incoming logic levels of the pins, regardless of whether the pin is defined as an input or output by the Configuration Register. They act only on the read operation. Writes to this register have no effect. The default value (X) is determined by the externally applied logic level. Before a read operation, a write transmission is sent with the command byte to indicate to the I<sup>2</sup>C device that the Input Port Register will be accessed next.

Register 0 (Input Port Register)

BIT	I-7	I-6	I-5	I-4	I-3	I-2	I-1	I-0
DEFAULT	X	X	X	X	X	X	X	X

The Output Port Register (register 1) shows the outgoing logic levels of the pins defined as outputs by the Configuration Register. Bit values in this register have no effect on pins defined as inputs. In turns, reads from this register reflect the value that is in the flip-flop controlling the output selection, not the actual pin value.

Register 1 (Output Port Register)

BIT	O-7	O-6	O-5	O-4	O-3	O-2	O-1	O-0
DEFAULT	1	1	1	1	1	1	1	1

The Polarity Inversion Register (register 2) allows polarity inversion of the pins defined as inputs by the Configuration Register. If a bit in this register is set (written with 1), the corresponding port pin's polarity is inverted. If a bit in this register is clear (written with a 0), the corresponding port pin's original polarity is retained.

Register 2 (Polarity Inversion Register)

BIT	N-7	N-6	N-5	N-4	N-3	N-2	N-1	N-0
DEFAULT	0	0	0	0	0	0	0	0

The Configuration Register (register 3) configures the direction of the I/O pins. If a bit in this register is set to 1, the corresponding port pin is enabled as an input with a high-impedance output driver. If a bit in this register is cleared to 0, the corresponding port pin is enabled as an input.

Register 3 (Configuration Register)

BIT	C-7	C-6	C-5	C-4	C-3	C-2	C-1	C-0
DEFAULT	1	1	1	1	1	1	1	1

## Function Description

I2CWriteByte(SlaveAddr, SubAddr, Data):  
Write a Byte data to a specified I2C Device.

I2CReadByte(SlaveAddr, SubAddr, \*Data):  
Read a Byte data from a specified I2C Device.

SetBit(\*Data, Bit) :  
Set Data bit n as "1".

ClrBit(\*Data, Bit) :  
Set Data bit n as "0".

GetBit(Data, Bit) :  
Return the value of data bit n.

## Sample Code

### GPIO Configuration

```
#define SLAVE_ADDR      0x42
#define INPUT_PORT     0x00
#define OUTPUT_PORT    0x01
#define INVERSION_PORT 0x02
#define COMFIG_PORT    0x03

GpioConfig(int PinNum, int Mode)
{
    BYTE Data;
    BYTE TempPinNum = PinNum%8;

    //Pin0-7 Input/Output Configuration
    I2C_ReadByte(SLAVE_ADDR, COMFIG_PORT, &Data);
    if(Mode == 1){SetBit(&Data, TempPinNum);} //Input
    else      {ClrBit(&Data, TempPinNum);} //Output
    I2C_WriteByte(SLAVE_ADDR, COMFIG_PORT, Data);

    return 1;
}
```

### GPIO Output Process

```
#define SLAVE_ADDR      0x42
#define INPUT_PORT     0x00
#define OUTPUT_PORT    0x01
#define INVERSION_PORT 0x02
#define COMFIG_PORT    0x03

GpioOut(int PinNum, int Level)
{
    BYTE Data;
    BYTE TempPinNum = PinNum%8;

    //Pin0-7
    I2C_ReadByte(SLAVE_ADDR, OUTPUT_PORT, &Data);
    if(Level == 0){ClrBit(&Data, TempPinNum);}
    else      {SetBit(&Data, TempPinNum);}
    I2C_WriteByte(SLAVE_ADDR, OUTPUT_PORT, Data);

    return 1;
}
```

### GPIO Input Process

```
#define SLAVE_ADDR      0x42
#define INPUT_PORT     0x00
#define OUTPUT_PORT    0x01
#define INVERSION_PORT 0x02
#define COMFIG_PORT    0x03

GpioIn(int PinNum, int *Status)
{
    BYTE Data;
    BYTE Group = PinNum/8;
    BYTE TempPinNum = PinNum%8;

    //Pin0-7
    I2C_ReadByte(SLAVE_ADDR, INPUT_PORT, &Data);
    *Status = GetBit(Data, TempPinNum);

    return 1;
}
```

## Appendix A - Watchdog Sample Code

;Software programming example:

```

;-----
;(1) Enter Super IO Configuration mode
;-----
MOV     DX,4EH
MOV     AL,87H
OUT     DX,AL
OUT     DX,AL

;-----
;(2) Configuration Logical Device 8, register CRF0/CRF1 (WDT Control/WDT
timer)
;-----
MOV     DX,4EH
MOV     AL,07H           ;Ready to Program Logical Device
OUT     DX,AL

MOV     DX,4FH
MOV     AL,08H           ;Select Logical Device 8
OUT     DX,AL

MOV     DX,4EH
MOV     AL, F1H           ;Select watchdog timer register
OUT     DX,AL

MOV     DX,4FH
MOV     AL,10H           ;Set watchdog timer value
OUT     DX,AL

MOV     DX,4EH
MOV     AL, F0H           ;Select watchdog Control Register
OUT     DX,AL

MOV     DX,4FH
MOV     AL,02H           ;Set Watchdog Control Value
OUT     DX,AL

;-----
;(1) Exit extended function mode
;-----
MOV     DX,4EH
MOV     AL,AAH
OUT     DX,AL

```

## Appendix B - System Error Message

When the BIOS encounters an error that requires the user to correct something, either a beep code will sound or a message will be displayed in a box in the middle of the screen and the message, PRESS F1 TO CONTINUE, CTRL-ALT-ESC or DEL TO ENTER SETUP, will be shown in the information box at the bottom. Enter Setup to correct the error.

### Error Messages

One or more of the following messages may be displayed if the BIOS detects an error during the POST. This list indicates the error messages for all Awards BIOSes:

#### CMOS BATTERY HAS FAILED

The CMOS battery is no longer functional. It should be replaced.



#### Important:

Danger of explosion if battery incorrectly replaced. Replace only with the same or equivalent type recommended by the manufacturer. Dispose of used batteries according to the battery manufacturer's instructions.

#### CMOS CHECKSUM ERROR

Checksum of CMOS is incorrect. This can indicate that CMOS has become corrupt. This error may have been caused by a weak battery. Check the battery and replace if necessary.

#### DISPLAY SWITCH IS SET INCORRECTLY

The display switch on the motherboard can be set to either monochrome or color. This indicates the switch is set to a different setting than indicated in Setup. Determine which setting is correct, either turn off the system and change the jumper or enter Setup and change the VIDEO selection.

#### FLOPPY DISK(S) fail (80)

Unable to reset floppy subsystem.

#### FLOPPY DISK(S) fail (40)

Floppy type mismatch.

#### Hard Disk(s) fail (80)

HDD reset failed.

#### Hard Disk(s) fail (40)

HDD controller diagnostics failed.

#### Hard Disk(s) fail (20)

HDD initialization error.

#### Hard Disk(s) fail (10)

Unable to recalibrate fixed disk.

#### Hard Disk(s) fail (08)

Sector Verify failed.

#### Keyboard is locked out - Unlock the key

The BIOS detects that the keyboard is locked. Keyboard controller is pulled low.

#### Keyboard error or no keyboard present

Cannot initialize the keyboard. Make sure the keyboard is attached correctly and no keys are being pressed during the boot.

#### Manufacturing POST loop

System will repeat POST procedure infinitely while the keyboard controller is pull low. This is also used for the M/B burn in test at the factory.

#### BIOS ROM checksum error - System halted

The checksum of ROM address F0000H-FFFFFFH is bad.

#### Memory test fail

The BIOS reports memory test fail if the memory has error(s).

## Appendix C - Troubleshooting Checklist

### Troubleshooting Checklist

This chapter of the manual is designed to help you with problems that you may encounter with your personal computer. To efficiently troubleshoot your system, treat each problem individually. This is to ensure an accurate diagnosis of the problem in case a problem has multiple causes.

Some of the most common things to check when you encounter problems while using your system are listed below.

1. The power switch of each peripheral device is turned on.
2. All cables and power cords are tightly connected.
3. The electrical outlet to which your peripheral devices are connected is working. Test the outlet by plugging in a lamp or other electrical device.
4. The monitor is turned on.
5. The display's brightness and contrast controls are adjusted properly.
6. All add-in boards in the expansion slots are seated securely.
7. Any add-in board you have installed is designed for your system and is set up correctly.

### Monitor/Display

**If the display screen remains dark after the system is turned on:**

1. Make sure that the monitor's power switch is on.
2. Check that one end of the monitor's power cord is properly attached to the monitor and the other end is plugged into a working AC outlet. If necessary, try another outlet.
3. Check that the video input cable is properly attached to the monitor and the system's display adapter.
4. Adjust the brightness of the display by turning the monitor's brightness control knob.

**The picture seems to be constantly moving.**

1. The monitor has lost its vertical sync. Adjust the monitor's vertical sync.
2. Move away any objects, such as another monitor or fan, that may be creating a magnetic field around the display.
3. Make sure your video card's output frequencies are supported by this monitor.

**The screen seems to be constantly wavering.**

1. If the monitor is close to another monitor, the adjacent monitor may need to be turned off. Fluorescent lights adjacent to the monitor may also cause screen wavering.

### Power Supply

**When the computer is turned on, nothing happens.**

1. Check that one end of the AC power cord is plugged into a live outlet and the other end properly plugged into the back of the system.
2. Make sure that the voltage selection switch on the back panel is set for the correct type of voltage you are using.
3. The power cord may have a "short" or "open". Inspect the cord and install a new one if necessary.

### Floppy Drive

**The computer cannot access the floppy drive.**

1. The floppy diskette may not be formatted. Format the diskette and try again.
2. The diskette may be write-protected. Use a diskette that is not write-protected.
3. You may be writing to the wrong drive. Check the path statement to make sure you are writing to the targeted drive.
4. There is not enough space left on the diskette. Use another diskette with adequate storage space.

## Hard Drive

### Hard disk failure.

1. Make sure the correct drive type for the hard disk drive has been entered in the BIOS.
2. If the system is configured with two hard drives, make sure the bootable (first) hard drive is configured as Master and the second hard drive is configured as Slave. The master hard drive must have an active/bootable partition.

### Excessively long formatting period.

If your hard drive takes an excessively long period of time to format, it is likely a cable connection problem. However, if your hard drive has a large capacity, it will take a longer time to format.

## Serial Port

### The serial device (modem, printer) doesn't output anything or is outputting garbled characters.

1. Make sure that the serial device's power is turned on and that the device is on-line.
2. Verify that the device is plugged into the correct serial port on the rear of the computer.
3. Verify that the attached serial device works by attaching it to a serial port that is working and configured correctly. If the serial device does not work, either the cable or the serial device has a problem. If the serial device works, the problem may be due to the onboard I/O or the address setting.
4. Make sure the COM settings and I/O address are configured correctly.

## Keyboard

### Nothing happens when a key on the keyboard was pressed.

1. Make sure the keyboard is properly connected.
2. Make sure there are no objects resting on the keyboard and that no keys are pressed during the booting process.

## System Board

1. Make sure the add-in card is seated securely in the expansion slot. If the add-in card is loose, power off the system, re-install the card and power up the system.
2. Check the jumper settings to ensure that the jumpers are properly set.
3. Verify that all memory modules are seated securely into the memory sockets.
4. Make sure the memory modules are in the correct locations.
5. If the board fails to function, place the board on a flat surface and seat all socketed components. Gently press each component into the socket.
6. If you made changes to the BIOS settings, re-enter setup and load the BIOS defaults.